

GRUPA  
topex

# NARZEDZIA RĘCZNE

HAND TOOLS

РУЧНИ

ІНСТРУМЕНТИ



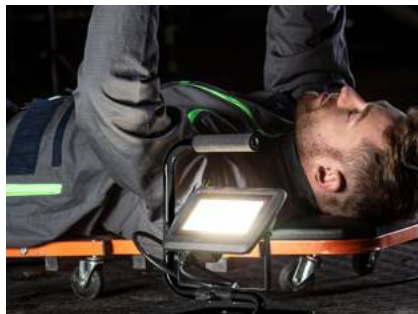
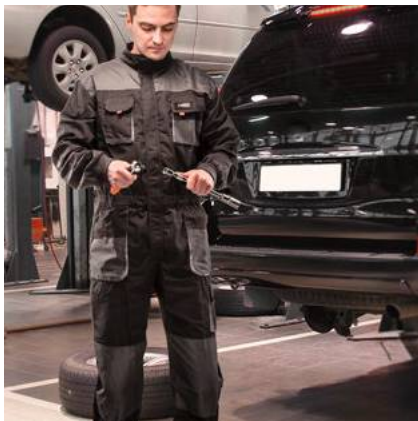
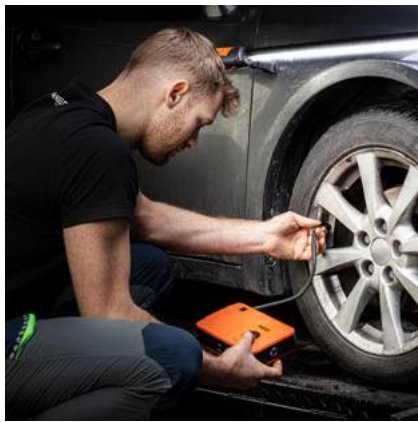
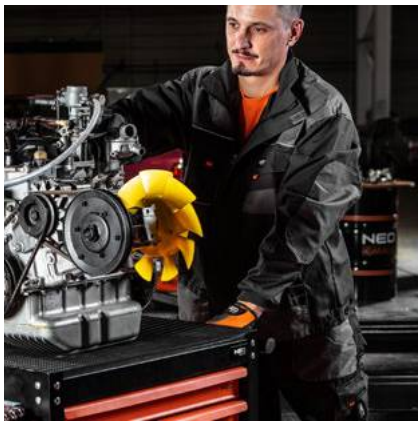

GRUPA  
topex

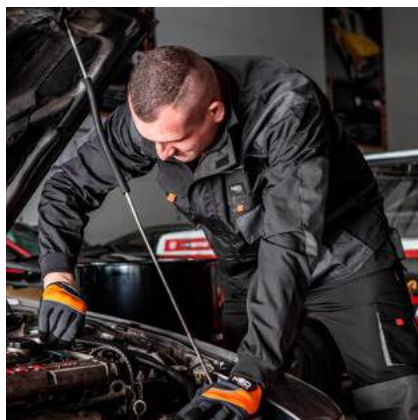
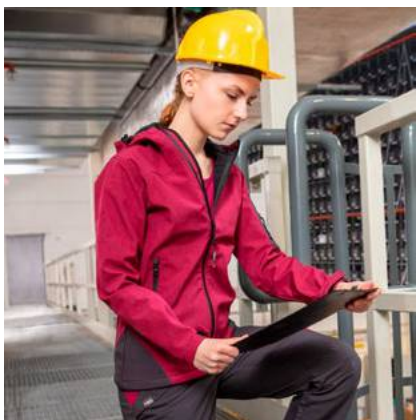

Większość produktów w tym katalogu promują nasi pracownicy, bo Grupa TOPEX to przede wszystkim ludzie.

Most of the people, portrayed in the pictures in this catalogue, who are using our tools are the employees of the Grupa TOPEX, because we believe that our company is all about people.

Більшість продуктів, представлених в цьому каталозі, просуваються нашими співробітниками, адже Група компаній TOPEX - це, перш за все, люди.



## Katalog narzędzi ręcznych 2023 Catalogue of hand tools 2023

Szanowni Państwo,

z dużą satysfakcją oddajemy w Państwa ręce nowe wydanie katalogu produktowego, zawierającego narzędzia ręczne. Głęboko wierzymy, że po raz kolejny spotka się on z Państwa uznaniem. Dołożyliśmy wszelkich starań, aby ta publikacja była przyjaznym i skutecznym narzędziem w Państwa rękach.

Z życzeniami powodzenia w biznesie,

Dear Customers,

It is with great satisfaction that we present to you the new edition of our product catalogue containing hand tools. We firmly believe that it will once again meet with your appreciation. We have done our best to make this publication a user-friendly and effective tool in your hands.

Good luck in business,

Piotr Potowski  
Dyrektor Generalny  
General Manager





Działamy na ponad 40 rynkach zagranicznych.

We operate on over 40 foreign markets.

Ми працюємо більш ніж на 40 закордонних ринках.

Klienci to siła napędowa naszej firmy. Współpracujemy z 4000 partnerów handlowych na całym świecie.

Our customers drive the operations of our Company. We cooperate with 4,000 business partners around the world.

Клієнти є рушійною силою нашої компанії. Ми працюємо з 4 000 торговими партнерами по всьому світу.



Nasza oferta produktowa to ponad 7200 pozycji asortymentowych.

Our product portfolio covers over 7200 articles.

Наша продукція налічує понад 7200 асортиментних позицій.

Zarządzamy portfelem 5 marek produktowych: NEO TOOLS, GRAPHITE, VERTO, TOPEX, TOP TOOLS.

We manage a portfolio covering 5 product brands: NEO TOOLS, GRAPHITE, VERTO, TOPEX, TOP TOOLS.

Ми управляємо портфелем з 5 продуктивих брендів: NEO TOOLS, GRAPHITE, VERTO, TOPEX, TOP TOOLS.

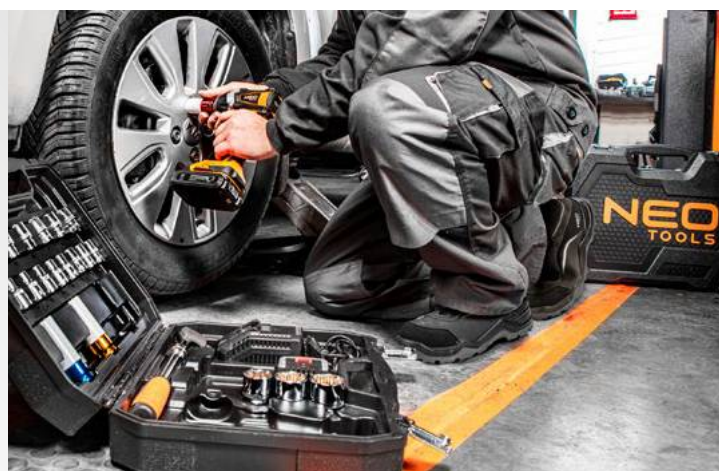



**TÜV ISO 9001:2015**

Laboratorium w którym badane są nasze produkty posiada certyfikat zgodności z jedną z najważniejszych regulacji dotyczących kontroli jakości, czyli ISO 9001:2015.

The laboratory where our products are tested is certified to one of the most important quality control regulations, ISO 9001:2015.

Лабораторія, в якій тестується наша продукція, сертифікована на відповідність одному з найважливіших стандартів контролю якості ISO 9001:2015.

Realizujemy dostawy poprzez nowoczesne centrum logistyczne.

We deliver through a modern Logistics center.

Доставляємо через сучасний логістичний центр.



Ponad 600 naszych pracowników dba o właściwy poziom obsługi naszych partnerów handlowych.

More than 600 of our employees care for the right level of our business partner service level.

Понад 600 наших співробітників забезпечують належний рівень сервісу для наших ділових партнерів.

Biznes nie kończy się na realizacji zamówienia. Stała dostępność części zamiennych do naszych produktów oraz profesjonalny serwis gwarancyjny i pogwarancyjny zapewnia GTX Service.

Business does not end with order fulfillment. Ongoing availability of spare parts for our products, and professional warranty and non-warranty services are provided by GTX Service.

На виконанні замовлення справа не закінчується. Постійна наявність запасних частин до нашої продукції та професійне гарантійне і післягарантійне обслуговування забезпечує компанія GTX Service.

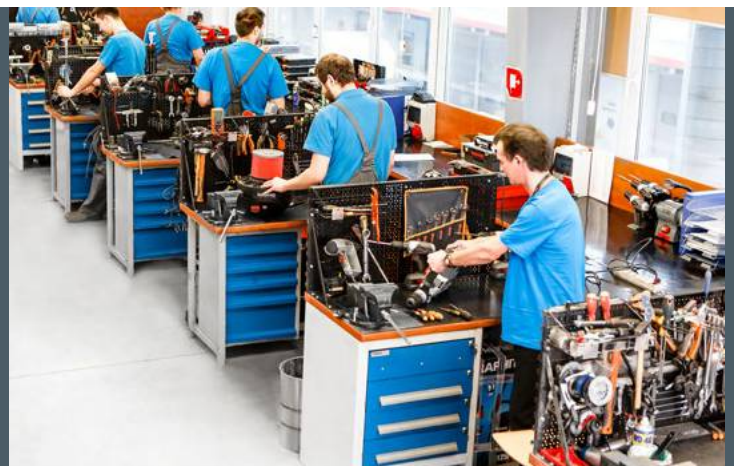

UŁATWIAMY ŻYCIE LUDZIOM, KTÓRZY UŻYWAJĄ NARZĘDZI.  
WE MAKE LIFE EASIER FOR PEOPLE WHO USE TOOLS.  
МИ ПОЛЕГШУЄМО ЖИТТЯ ЛЮДЯМ, ЯКІ КОРИСТУЮТЬСЯ ІНСТРУМЕНТАМИ.

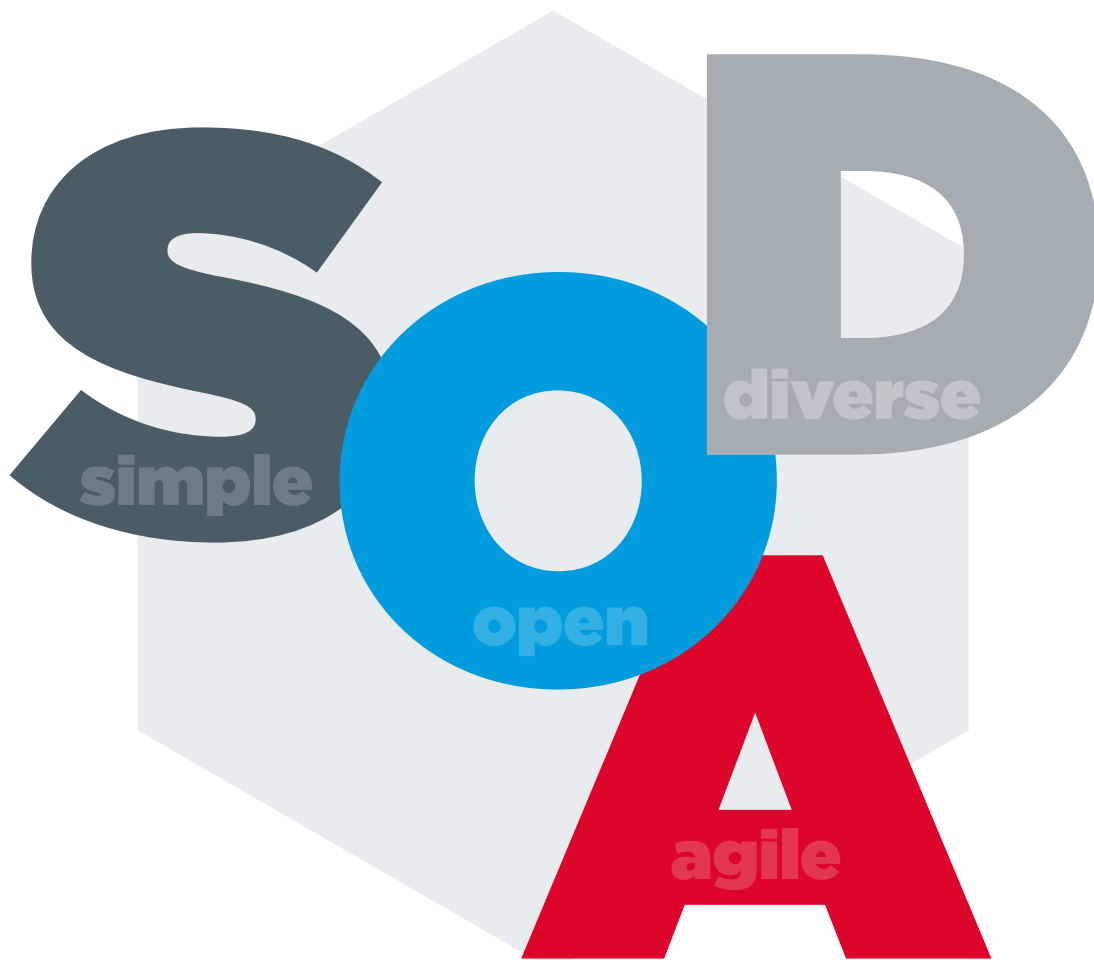

**UPRASZCZANIE**  
**SIMPLE**  
**СПРОЩЕННЯ**

Maksymalne uproszczenie wszelkich podejmowanych działań poprzez kulturę poszukiwania prostszych rozwiązań.

Maximum simplification of any action taken through a culture of seeking simpler solutions and openness to a certain level of risk and imperfection.

Максимально спростити будь-які дії, що вживаються, через культуру пошуку більш простих рішень.

**OTWARTOŚĆ**  
**OPEN**  
**ВІДКРИТІСТЬ**

Otwarta komunikacja budowana poprzez otwarty styl zarządzania, wspierana żywą kulturą informacji zwrotnej.

Open communication in the team built through an open management style, supported by a vibrant culture of feedback.

Відкрита комунікація, побудована на основі відкритого стилю управління, що підтримується активною культурою зворотного зв'язку.

**RÓŻNORODNOŚĆ**  
**DIVERSE**  
**РІЗНОМАНІТНІСТЬ**

Zróżnicowanie pod każdym względem, zarówno w zakresie działań biznesowych jak i zespołu.

Diversity in every aspect, either in terms of business activities or team.

Різноманітність у всіх відношеннях, як з точки зору бізнес-операцій, так і з точки зору команди.

**ELASTYCZNOŚĆ**  
**AGILE**  
**ГНУЧКІСТЬ**

Dostosowanie się do otoczenia i orientacja na faktyczne i aktualne potrzeby rynku.

Agile, adaptation to the environment and orientation to the current and actual market needs.

Адаптація до зовнішнього середовища та орієнтація на актуальні та поточні потреби ринку.

Katalog główny narzędzi ręcznych 2023 ułożony jest kategoriami produktowymi, pochodzącymi z naszych wszystkich marek, które obejmują narzędzia ręczne. Układ stanowi odpowiedź na potrzeby Klientów. Celem takiego układu jest pokazanie przekrojowości asortymentu w ramach poszczególnych grup produktowych oraz ułatwienie nawigacji.

The main catalog of hand tools 2023 is arranged by product categories coming from all our brands which include hand tools. The layout responds to the needs of customers. A purpose of such arrangements is to show the cross-sectional assortment and facilitating navigation.

Майстер-каталог ручних інструментів 2023 року упорядкований за категоріями продукції всіх наших брендів, які охоплюють ручні інструменти. Нове компонування є відповіддю на потреби клієнтів. Мета цієї структури - показати зріз асортименту продукції в межах кожної товарної групи та полегшити навігацію.

**NEO**  
TOOLS

**TOPEX**

**VERTO**

**TOP TOOLS**



# NEO TOOLS



**25**  
years  
GUARANTEE





## NEO TOOLS to...

- wysokiej klasy specjalistyczne i popularne narzędzia dla profesjonalistów, wymagających użytkowników oraz osób realizujących różne prace w domu
- w skład marki wchodzi wiele kategorii produktowych
- główne filary marki stanowi kategoria moto oraz BHP
- NEO Tools rozwija się również w zupełnie nowych obszarach, które idealnie wpisują się w męski świat
- marka pomaga realizować zarówno ciężkie zadania jak i swoje pasje
- w produkcji wykorzystane są najnowsze technologie i materiały
- 25 lat gwarancji\* jakości i niezawodności

## NEO TOOLS is...

- high-quality specialist and popular tools for professionals, demanding users and those who perform various works at home
- the brand includes many different product categories
- the main categories of the brand are Moto and OHS
- NEO Tools is also expanding in completely new areas that perfectly fit the male world
- the brand helps to perform both difficult tasks and fulfil one's passions
- in the production we use the latest technologies and materials
- 25 years of quality and reliability guarantee\*

## NEO TOOLS це...

- високі класні спеціалізовані та популярні інструменти для професіоналів, вимогливих користувачів та людей, які виконують різноманітні роботи по дому
- бренд включає в себе багато товарних категорій
- основними стовпами бренду є категорії „мото” та охорона праці
- NEO Tools також розвивається в абсолютно нових напрямках, які ідеально вписуються в чоловічий світ
- бренд допомагає реалізовувати як свою професійну працю, так і свої хобі
- у виробництві використовуються новітні технології та матеріали
- 25 років гарантії\* якості та надійності



[neo-tools.com](http://neo-tools.com)



@NEOTOOLS



Informacje o nowościach produktowych, wydarzeniach, konkursy, porady oraz video

Information about novelities, events, competitions, tips and videos

Інформація про нові продукти, події, конкурси, поради та відео



@NEOTOOLSOFFICIAL



VIDEO produktowe, porównania i testy produktów w wielu wersjach językowych

Product related VIDEOS, product comparisons and tests in multiple language versions

ВІДЕО про продукцію, порівняння продукції та тести на декількох мовах



NEOmov





## JAKOŚĆ

Najwyższa jakość materiałów i najnowocześniejsze rozwiązania technologiczne to kluczowe założenia standardów jakości NEO. Narzędzia NEO to ergonomiczne, precyzyjnie wykonane narzędzia stworzone do pracy w najcięższych warunkach. Produkty NEO testowane są zarówno w specjalistycznych laboratoriach jak i w miejscach pracy profesjonalistów.

## QUALITY

High quality of materials and well proven technical solutions are the key foundations of the NEO quality standards. High quality and precision of workmanship make the NEO tools fit for use in the harshest conditions. NEO products are tested in specialised laboratories as well as in professionals' workplaces.

## ЯКІСТЬ

Найвища якість матеріалів та найсучасніші технологічні рішення - головні засади стандартів якості NEO. Інструменти NEO - це ергономічні, точно виготовлені інструменти, створені для роботи в найскладніших умовах. Продукція NEO тестується як у спеціалізованих лабораторіях, так і на робочих місцях професіоналів.

## Laboratorium

Narzędzia NEO poddawane są specjalistycznym i rygorystycznym testom wytrzymałościowym. System zarządzania jakością, stosowany w Laboratorium, w którym badane są narzędzia NEO, posiada certyfikat zgodności z jedną z najważniejszych regulacji dotyczących kontroli jakości, czyli ISO 9001:2015.

## Laboratory

NEO tools undergo specialized and rigorous endurance testing. The quality management system used in the Laboratory, where NEO tools are tested, is certified to one of the most important quality control regulations, ISO 9001:2015.

## Лабораторія

Інструменти NEO піддаються спеціалізованим і суворим випробуванням на міцність. Система управління якістю, яка використовується в лабораторії, де проводяться випробування інструментів NEO, сертифікована на відповідність одному з найважливіших стандартів контролю якості - ISO 9001:2015.





W procesie produkcji wykorzystywane są starannie wyselekcjonowane materiały, a jakość narzędzi jest stale weryfikowana w trakcie rygorystycznych procedur kontrolnych. Produkty NEO spełniają najwyższe kryteria jakościowe, czego znakiem jest 25-letni okres ochrony gwarancyjnej na narzędzia mechaniczne NEO.

Manufacturing process uses carefully selected materials, and the tool quality is constantly verified with rigorous control procedures. NEO products meet the highest quality criteria, which is confirmed with 25 years warranty for NEO mechanical tools.

У процесі виробництва використовуються ретельно відібрані матеріали, а якість інструментів постійно перевіряється під час суворих процедур контролю. Продукція NEO відповідає найвищим критеріям якості, ознакою чого є 25-річний гарантійний захист механічних інструментів NEO.

Narzędzia NEO cieszą się zaufaniem wymagających użytkowników oraz profesjonalistów, którzy poszukują rozwiązań na najwyższym poziomie. O niezawodności i uznaniu ze strony środowiska biznesowego świadczą liczne wyróżnienia. Najważniejszym z nich jest międzynarodowy certyfikat TÜV, który jest jednym z najbardziej rozpoznawalnych znaków jakości na świecie.

NEO tools earned trust of demanding users and professionals who search for solutions of the highest standards. Reliability and recognition in the business sector are confirmed with numerous prizes and distinctions. The most important of all is the international TÜV certificate, one of the most recognised quality marks in the world.

Інструменти NEO користуються довірою вимогливих користувачів і професіоналів, які шукають рішення на найвищому рівні. Про надійність та визнання з боку бізнес-спільноти свідчать численні нагороди. Найважливішим з них є міжнародний сертифікат TÜV, який є одним з найбільш визнаних знаків якості у світі.



## TESTOWANIE NARZĘDZI

Narzędzia mechaniczne i warsztatowe marki NEO Tools są testowane nie tylko laboratoryjnie, ale przede wszystkim w realnych warunkach pracy. Nasze narzędzia zanim wejdą na rynek używane są w profesjonalnym warsztacie mechanicznym NEO Garage.

Dzięki temu możemy zaoferować Państwu najwyższej jakości produkty przeznaczone do pracy w branży motoryzacyjnej.

## TOOL TESTING

NEO Tools brand mechanical and workshop tools are tested not only in the laboratory, but also in real working conditions. Before they enter the market, our tools are used in the professional mechanical workshop NEO Garage.

This allows us to offer you the highest quality products for automotive work.

## ВИПРОБУВАННЯ ІНСТРУМЕНТУ

Механічний та слюсарний інструмент торгової марки NEO Tools тестується не тільки в лабораторії, але, перш за все, в реальних робочих умовах. Наші інструменти перед виходом на ринок проходять випробування в професійній механічній майстерні NEO Garage.

Завдяки цьому ми можемо запропонувати Вам продукцію найвищої якості для автомобільних робіт.

# NEO

# GARAGE



# NEO GARAGE

## GARAŻ GARAGE ГАРАЖ

NEO Garage oferuje rozbudowaną i dopasowaną do potrzeb użytkowników ofertę garażowania różnego typu pojazdów

NEO Garage offers an extensive and tailor-made offer for garaging various types of vehicles.

NEO Garage proponuje szeroką i indywidualną propozycję dla zberigannya różnych typów transportnych zasobів

neogarage.pl



## SALA KONFERENCYJNA CONFERENCE ROOM КОНФЕРЕНЦ-ЗАЛ

Możliwość organizacji spotkań biznesowych w wyjątkowym otoczeniu.

Exceptional environment for business meetings.

Можливість організації ділових зустрічей в унікальній обстановці.

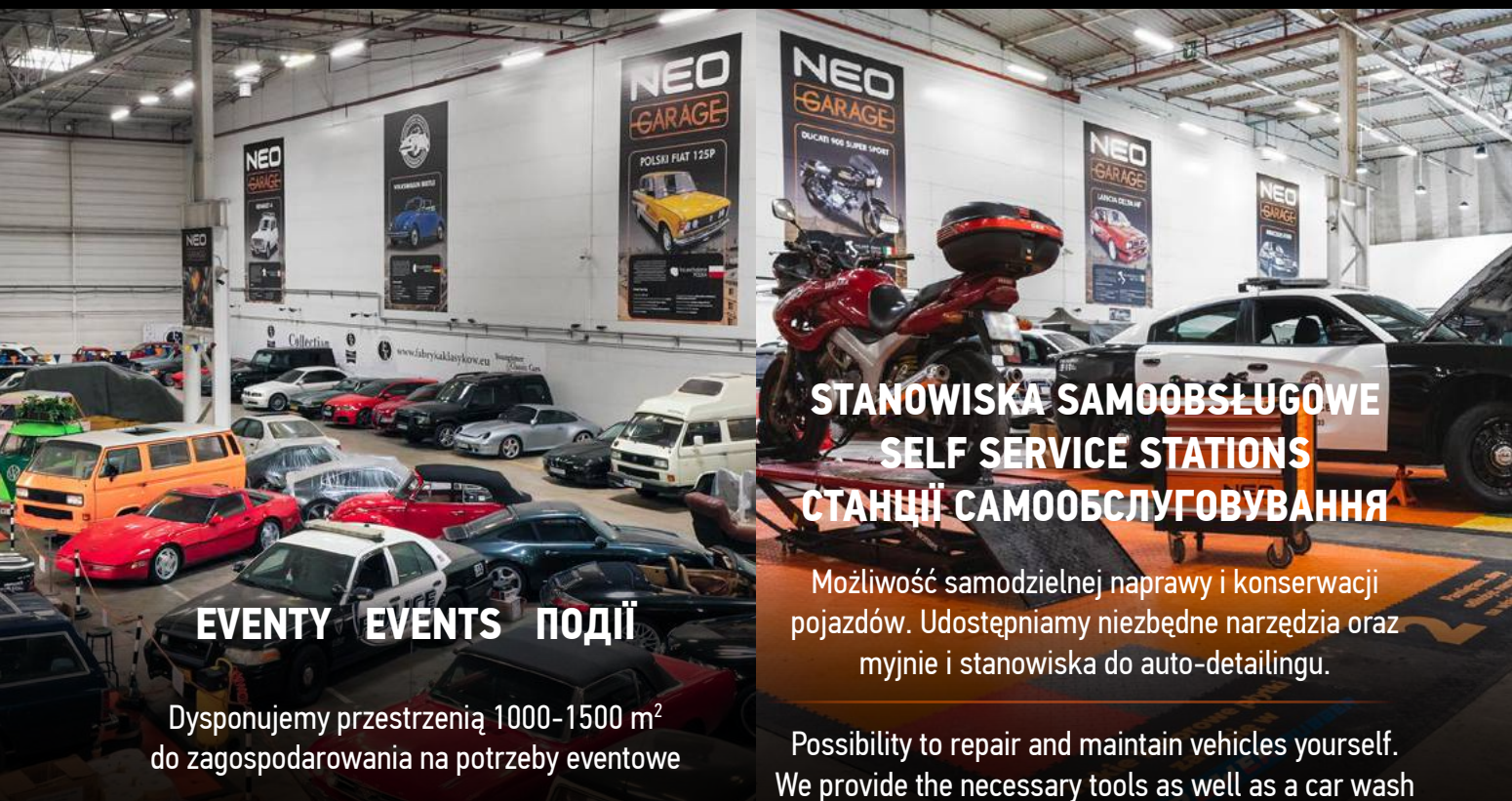

## EVENTY EVENTS ПОДІЇ

Dysponujemy przestrzenią 1000-1500 m<sup>2</sup> do zagospodarowania na potrzeby eventowe

We have 1,000-1500 m<sup>2</sup> of space available for event use.

Маємо простір 1000-1500 м<sup>2</sup> для проведення заходів

## STANOWISKA SAMOBSŁUGOWE SELF SERVICE STATIONS СТАНЦІ САМООБСЛУГОВУВАННЯ

Możliwość samodzielnej naprawy i konserwacji pojazdów. Udostępniamy niezbędne narzędzia oraz myjnię i stanowiska do auto-detailingu.

Possibility to repair and maintain vehicles yourself. We provide the necessary tools as well as a car wash and auto-detailing stands.

Можливість самостійно ремонтувати та обслуговувати транспортні засоби. Ми надаємо необхідні інструменти, а також автомийки та стенди для автосервісу.

# ODZIEŻ MARKI NEO TOOLS

laureatem prestiżowej nagrody

**DOBRY WZÓR 2022!**

# NEO TOOLS CLOTHING

winner of the prestigious

**GOOD DESIGN 2022** award!

# БРЕНДОВИЙ ОДЯГ NEO TOOLS

лауреат престижної премії

**ГАРНИЙ ДИЗАЙН 2022!**

W finale konkursu najwyższe odznaczenie otrzymały:

In the finals of the competition, the highest honor went to:

У фіналі конкурсу було присуджено найвищу нагороду:

**81-217 81-227**



**TOPEX to:**

- to jedna z najbardziej rozpoznawalnych marek narzędzi ręcznych w Polsce
- szeroki asortyment solidnie wykonanych narzędzi w atrakcyjnej cenie
- produkty ogólnie dostępne i niezbędne w każdym domu

**TOPEX is:**

- one of the best recognised hand tool brands in Poland
- a wide range of sturdy design tools at attractive prices
- products easily available and indispensable at every home

**TOPEX це:**

- є одним з найбільш впізнаваних брендів ручного інструменту в Польщі
- широкий асортимент добротних інструментів за привабливими цінами
- продукти, які є широкодоступними та незамінними в кожному домогосподарстві

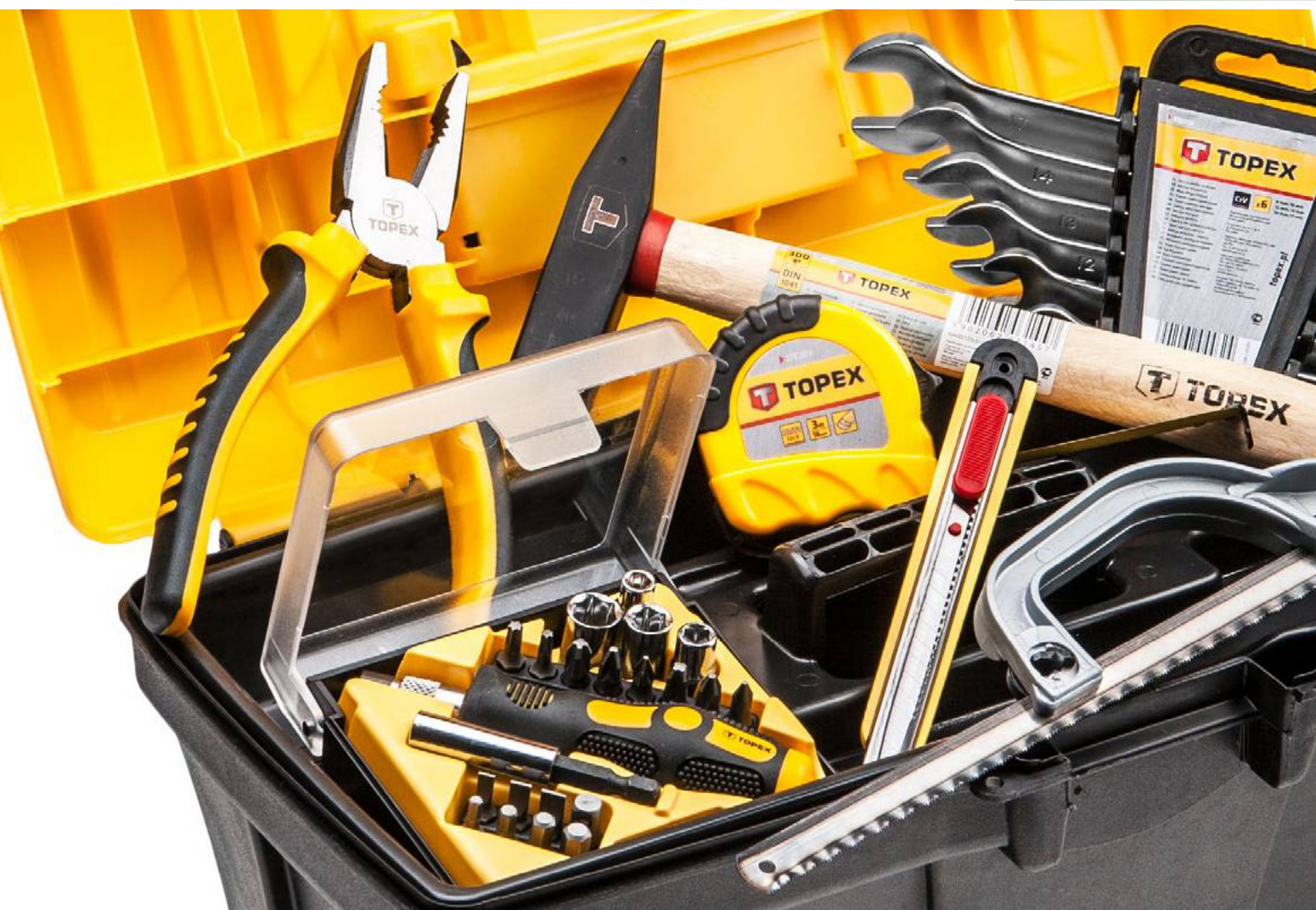





**Zapraszamy na kanały marki TOPEX w mediach społecznościowych**

**Come and browse TOPEX social media channels**

**Відвідайте сторінки бренду TOPEX в соціальних мережах**



**Sprytny.TOPEX**



Informacje o nowościach produktowych, porady oraz VIDEO

Information on new products, advice and VIDEOS

Інформація про нові продукти, події, конкурси, поради та відео



**TOPEXmov**



VIDEO produktowe, porównania i testy produktów w wielu wersjach językowych

Product related VIDEOS, product comparisons and tests in multiple language versions

ВІДЕО про продукцію, порівняння продукції та тести на декількох мовах



**TOPEX**



# TOP TOOLS

## RAZ, DWA ... I PO SPRAWIE

### TOP TOOLS to...

- gama podstawowych narzędzi ręcznych oraz klódek
- produkty w bardzo atrakcyjnych cenach do stosowania przy prostych pracach domowych

### TOP TOOLS means...

- a range of basic hand tools and padlocks
- products at very attractive prices for use in simple housework

### TOP TOOLS – це...

- асортимент основних ручних інструментів та навісних замків
- продукти за дуже привабливими цінами для використання в простих домашніх справах

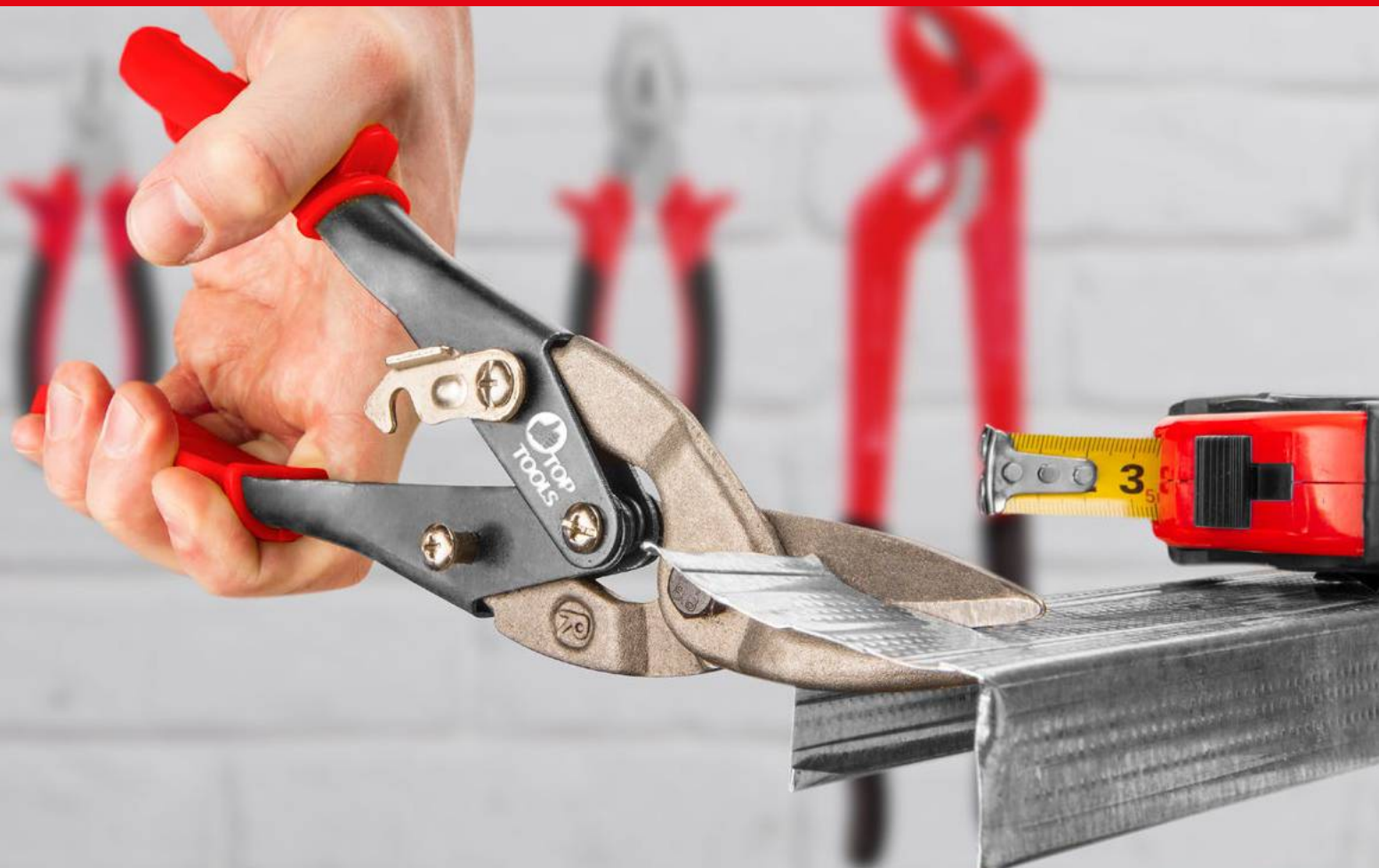



# VERTO



**JEST TYLE DO ZROBIENIA  
THERE IS SO MUCH TO DO  
ЩЕ ТАК БАГАТО ТРЕБА ЗРОБИТИ**

#### **VERTO to:**

- szeroka gama **narzędzi ogrodowych**, elektronarzędzi oraz akcesoriów do elektronarzędzi
- wszechstronne, wygodne w obsłudze rozwiązania w bardzo dobrej relacji jakości do ceny
- produkty idealnie sprawdzające się przy średnich obciążeniach

#### **VERTO is:**

- a wide range of **garden** and workshop tools, power tools and accessories
- versatile, convenient solutions with very good quality to price ratio
- products perfectly fit to moderate load

#### **VERTO це:**

- широкий асортимент садового інструменту, електроінструменту та аксесуарів до нього
- універсальні, зручні для користувача рішення з дуже хорошим співвідношенням ціни та якості
- продукти ідеально підходять для середніх навантажень



VERTOTOOLS



Informacje o nowościach produktowych, porady oraz VIDEO

Information on new products, advice and VIDEOS

Інформація про нові продукти, події, конкурси, поради та відео



VERTOTOOLS



VIDEO produktowe, porównania i testy produktów w wielu wersjach językowych

Product related VIDEOS, product comparisons and tests in multiple language versions

ВІДЕО про продукцію, порівняння продукції та тести на декількох мовах

Nasze wieloletnie doświadczenie i znajomość rynku elektronarzędzi pomogła nam w opracowaniu rozwiązań ekspozycji produktów, które wspierają naszych partnerów handlowych w codziennym biznesie.

- **unikalność** - regały dedykowane dla marki NEO Tools, Topex, Verto
- **solidność** - konstrukcje wykonane z dobrej jakości materiałów
- **nowoczesność** - ciekawe rozwiązanie na komunikację o produktach, markach, akcjach promocyjnych
- **uniwersalność** - odpowiednie dopasowanie do ilości miejsca w sklepie

Many years of experience and knowledge of tool market allowed us to develop solutions for product exposition, which create a great support in everyday business for our trade partners.

- **unique features** – cabinets dedicated for NEO Tools, Topex, Verto brands
- **reliability** – designs include good quality materials
- **modern design** – interesting solution for communication about products, brands, promotional events
- **versatility** – matching to space available in a shop

Наш багаторічний досвід і знання ринку електроінструментів допомогли нам розробити рішення для демонстрації продукції, які підтримують наших торгових партнерів в їх повсякденному бізнесі.

- **унікальність** - спеціалізовані стелажі для брендів NEO Tools, Topex, Verto
- **надійність** - конструкції виготовлені з якісних матеріалів
- **сучасність** - цікаве рішення для комунікації про продукцію, бренди, промо-акції
- **універсальність** - відповідне долаштування під кількість місця в магазині

**NEO**  
TOOLS

**TOPEX**

**VERTO**

**TOP TOOLS**

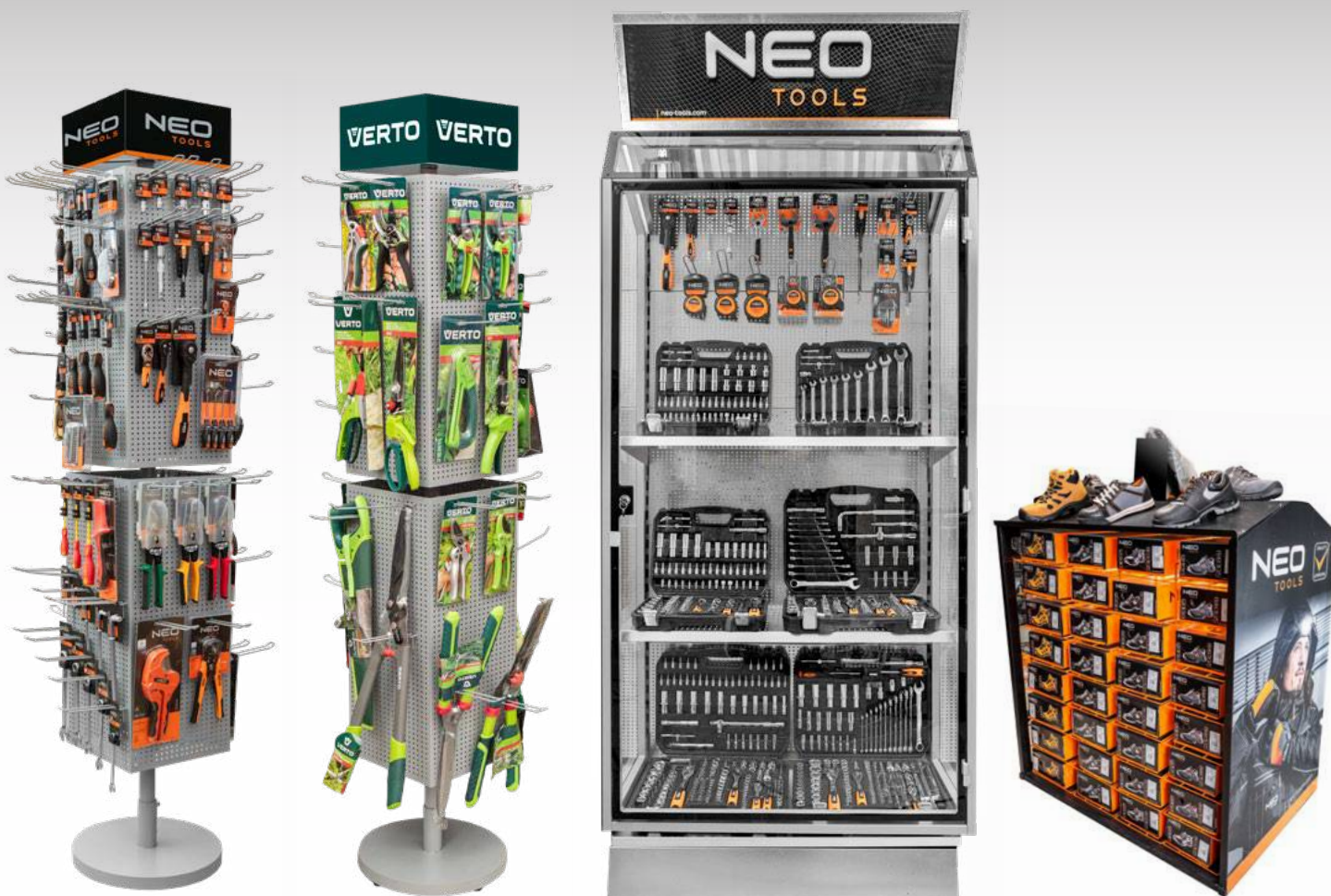

**OFERTA SZYTA NA MIARĘ**  
**TAILORED-MADE OFFER**  
**ІНДИВІДУАЛЬНА ПРОПОЗИЦІЯ**

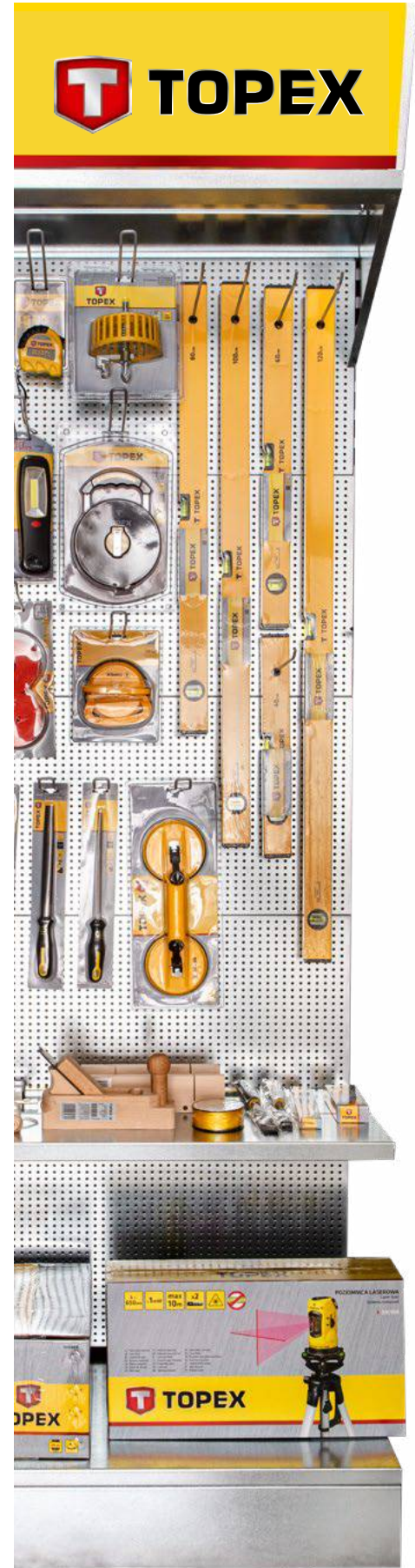
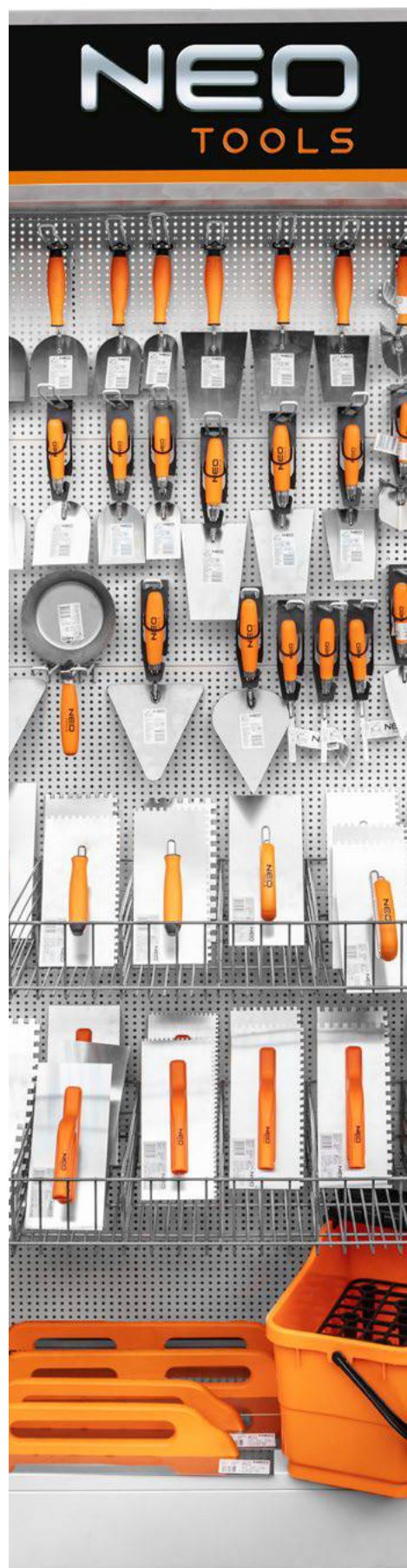

ZOBACZ RÓWNIEŻ KATALOG ELEKTRONARZĘDZI I AKCESORIÓW

SEE ALSO THE CATALOG OF POWER TOOLS AND ACCESSORIES

ДИВ. ТАКОЖ КАТАЛОГ ЕЛЕКТРОІНСТРУМЕНТІВ ТА АКЕСУАРІВ

**GRAPHITE**  
**VERTO**

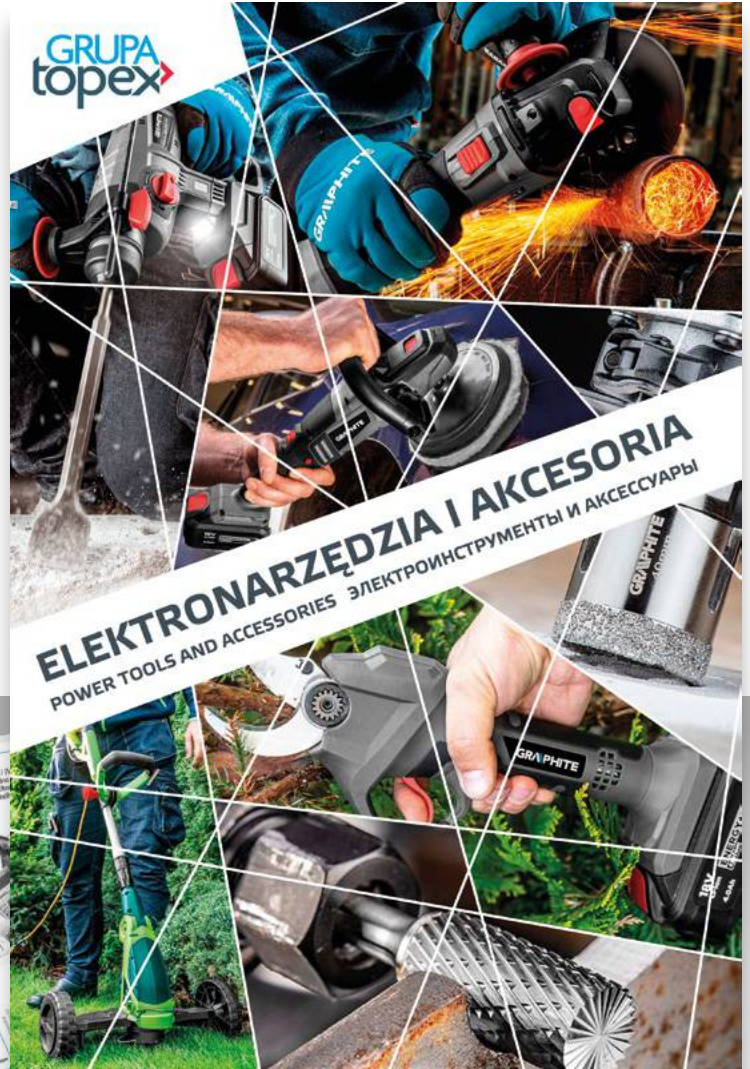

# SPIS TREŚCI OBRAZKOWY

## PICTURE LIST

## ІЛЮСТРОВАНІЙ ЗМІСТ

### NARZĘDZIA MECHANICZNE MECHANICAL TOOLS МЕХАНІЧНІ ІНСТРУМЕНТИ

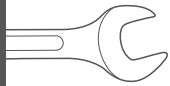

25



35



62



66



75



80



81



90



99



106



110



112

### SZCZYPCE PLIERS ЩИПЦІ

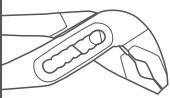

117

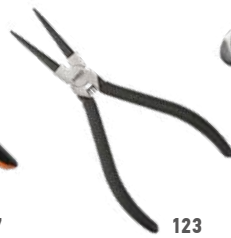

123



124



125



127



130



132



134



136



137



138



140



144



145

### MOTORYZACYJNE AUTOMOTIVE TOOLS АВТОМОБІЛЬНЕ

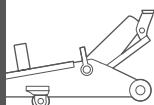

147



160



162



165



166



168



175



179



181



185



190

### PNEUMATYKA PNEUMATICS ПНЕВМАТИКА



195



200



202



204



206

### BHP OHS ОХОРОНА ПРАЦІ



210



220



227



229



235

# SPIS TREŚCI OBRAZKOWY

## PICTURE LIST

## ІЛЮСТРОВАНІЙ ЗМІСТ

BHP  
OHS  
ОХОРОНА ПРАЦІ



236



237

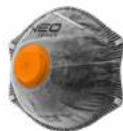

245



246



249



252

BUDOWLANE  
BUILDING  
БУДІВНИЦТВО

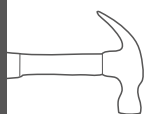

257



264



272



276



278



281



284



291



295



296



299



299



300

POMIAROWE  
MEASURING  
ВИМІРЮВАННЯ

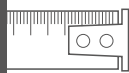

304



307



310



311



312

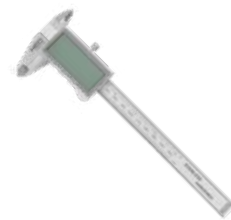

314

TRANSPORT  
TRANSPORTATION  
ТРАНСПОРТ

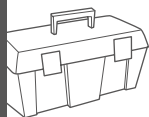

319



325



329



332



334

ŁĄCZĄCE  
JOINING  
З'ЄДНАННЯ

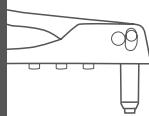

336



338



340



343



345



348

DEKORATORSKIE  
DECORATING  
ОЗДОБЛЮВАННЯ



351



357



358



359



364



366



# SPIS TREŚCI OBRAZKOWY

## PICTURE LIST

## ІЛЮСТРОВАНІЙ ЗМІСТ

### OSWIETLENIE WORKSHOP LIGHTING ОСВІТЛЕННЯ

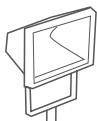

368



370



372



374



377

### SURVIVAL SURVIVAL SURVIVAL



380



381



384



386



388



389

### DOM I GARAŻ HOUSE AND GARAGE БУДИНОК І ГАРАЖ



392



393



394

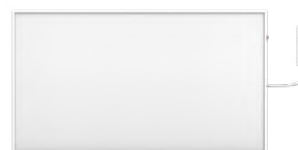

396



397

### OGRÓD GARDEN САД

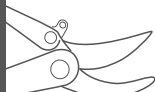

400



408



410



412



414



417



418



419



422



424



426



427



427

### ZABEZPIECZENIA PROTECTION БЕЗПЕКА



430



431

### GADŻETY GADGETS ГАДЖЕТИ



433



434



434

### AKCESORIA ROWEROWE BICYCLE ACCESSORIES АКСЕСУАРИ ДЛЯ ВЕЛОСИПЕДІВ



436



436



437



437



438



# NARZĘDZIA MECHANICZNE

MECHANICAL TOOLS

МЕХАНІЧНІ ІНСТРУМЕНТИ

## Szafka narzędziowa

Tool cabinet / Werkzeugschrank / Шкафчик для инструментов / Шафа інструментальна / Мűhelykocsi / Dulap pentru scule / Skříňka na nářadí / Skrinka na náradie / Omarica za orodje / Įrankių spintelė / Instrumentu skapis / Тööriistakapp / Шкафче за инструменти / Ormar za alate / Ormaric za alatke / Ντουλαπάκι για εργαλεία / Armario de almacenaje para herramientas / Carrello porta utensili / Estante p. Ferramentas / Rmoire à outils / Gereedschapskast

**NEO**  
TOOLS

25  
years  
GUARANTEE

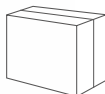

Ref.	D [mm]	W [mm]	H [mm]	capacity [kg]	☒	EAN
84-225	465	1105	978	600	0/1	5907558422269

**NEO**  
TOOLS

25  
years  
GUARANTEE

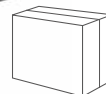

Ref.	D [mm]	W [mm]	H [mm]	capacity [kg]	☒	EAN
84-217	460	805	972	300	0/1	5907558482010

**NEO**  
TOOLS



**229 elements**



84-239 84-238 84-237 84-236 84-241 84-246



84-232 84-231 84-247 84-230 84-240 84-242



84-234 84-235 84-233 84-249

Ref.	D [mm]	W [mm]	H [mm]	capacity [kg]	☒	EAN
84-225+G	465	1105	978	600	0/1	5907558487503

**NEO**  
TOOLS



**149 elements**



84-235 84-234 84-233 84-232 84-231 84-244



84-238 84-237 84-236 84-240 84-230 84-242 84-249

Ref.	D [mm]	W [mm]	H [mm]	capacity [kg]	☒	EAN
84-217+G	460	805	972	300	0/1	5907558483062



## Szafka narzędziowa

Tool cabinet / Werkzeugschrank / Шкафчик для инструментов / Шафа інструментальна / Műhelykocsi / Dulap pentru scule / Skříňka na nářadí / Skrinka na náradie / Omarica za orodje / Įrankių spintelė / Instrumentu skapis / Тööriistakapp / Шкафче за инструменти / Ormar za alate / Ormaric za alatke / Ντουλαράκι για εργαλεία / Armario de almacenaje para herramientas / Carrello porta utensili / Estante p. Ferramentas / Rmoire à outils / Gereedschapskast

**NEO**  
TOOLS



25  
years  
GUARANTEE

**NEO**  
TOOLS



25  
years  
GUARANTEE

Ref.	D [mm]	W [mm]	H [mm]	capacity [kg]	☒	EAN
84-223	480	780	750	200	0/1	5907558422276

Ref.	D [mm]	W [mm]	H [mm]	capacity [kg]	☒	EAN
84-220	460	810	980	300	0/1	5907558418293

**NEO**  
TOOLS

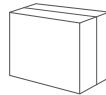

## 126 elements

1 szuflada / drawer / ящик

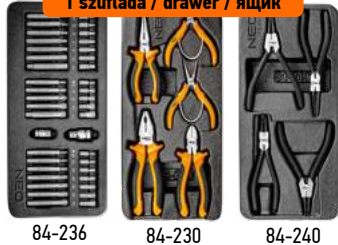

84-236

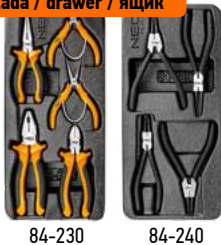

84-230



84-240

2 szuflada / drawer / ящик



84-238



84-232



84-231

3 szuflada / drawer / ящик



84-243



84-234



84-235

4 szuflada / drawer / ящик



84-249

Ref.	D [mm]	W [mm]	H [mm]	capacity [kg]	☒	EAN
84-223+G	480	780	750	200	0/1	5907558427097

**NEO**  
TOOLS



## 174 elements



84-249



84-239



84-238



84-237



84-232



84-231



84-247



84-236



84-230



84-242



84-234



84-235



84-233

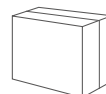

Ref.	D [mm]	W [mm]	H [mm]	capacity [kg]	☒	EAN
84-220+G	465	775	978	300	0/1	5907558465020



## Szafka narzędziowa

Tool cabinet / Werkzeugschrank / Шкафчик для инструментов / Шафа інструментальна / Műhelykocsi / Dulap pentru scule / Skříňka na nářadí / Skrinka na náradie / Omatrica za orodje / Įrankių spintelė / Instrumentu skapis / Тоїристакорп / Шкафче за инструменти / Ormar za alate / Ormaric za alatke / Ντουλαράκι για εργαλεία / Armario de almacenaje para herramientas / Carrello porta utensili / Estante p. Ferramentas / Rmoire à outils / Gereedschapskast

**NEO**  
TOOLS

25  
years  
GUARANTEE

**NEO**  
TOOLS

25  
years  
GUARANTEE

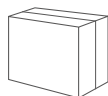
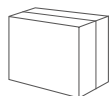

Ref.	D [mm]	W [mm]	H [mm]	capacity [kg]	☒	EAN
84-221	460	680	1030	280	0/1	5907558422238

Ref.	D [mm]	W [mm]	H [mm]	capacity [kg]	☒	EAN
84-222	460	680	1030	280	0/1	5907558422245

**NEO**  
TOOLS



**NEO**  
TOOLS

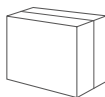

## 149 elements

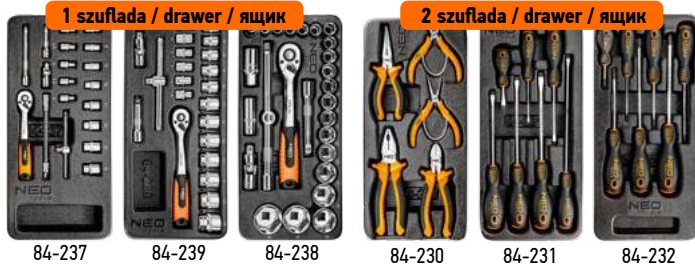

## 129 elements

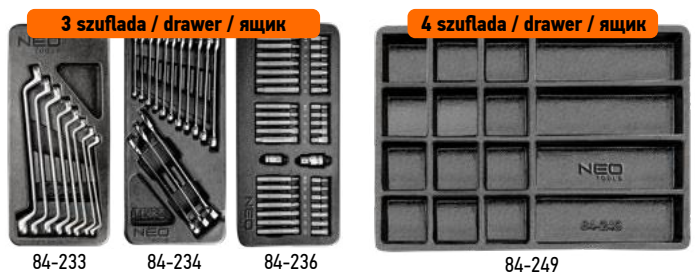
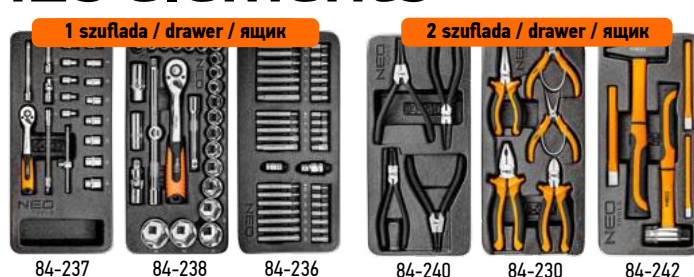

Ref.	D [mm]	W [mm]	H [mm]	capacity [kg]	☒	EAN
84-221+G	460	680	1030	280	0/1	5907558425840

Ref.	D [mm]	W [mm]	H [mm]	capacity [kg]	☒	EAN
84-222+G	460	680	1030	280	0/1	5907558425857



## Wózek warsztatowy

Workshop trolley / Werkstattrollwagen / Тележка для инструмента / Візок інструментальний / Műhely kocsí / Cărucior de atelier / Dílenský vozík / Dielenský vozík / Delavniški voziček / Vežimēlis dirbtuvėms / Instrumentu ratiņi / Töökajakäru / Работна количка / Kolica za radionicu / Radionička kolica / Καρότσι εργαλείων / Carrito de taller / Carrello portautensili / carrinho de oficina / Chariot d'atelier / Werkplaatskar

**NEO**  
TOOLS

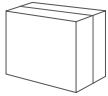

- Kompatybilne z wkładkami narzędziowymi NEO
- Compatible with NEO tool inserts
- Совместимость с инструментальными вставками NEO

Ref.	D [mm]	W [mm]	H [mm]	capacity [kg]	📦	EAN
84-229	390	630	810	130	0/1	5907558435610

## Szczypce

Pliers set / Zange / Клеци / Пласкозубци, набор / Fogókészlet / Set clește plat / Klešče / Kliešte, súprava / Klešče / Replės / Кнаиблу komplekts / Nāpītsate komplekt / Щипцы / Klijesta / Klesta set / Συλλογή πεισών / Alicates / Pinza / Pinças / Pince / Tangen

**NEO**  
TOOLS

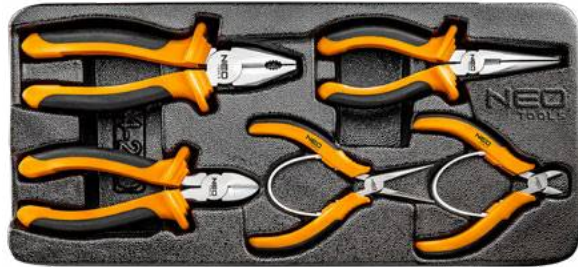

**x5**

55-60 HRC

DIN 5745

DIN 5746

DIN 5749



180 mm

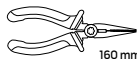

160 mm

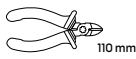

110 mm



160 mm



130 mm

Ref.	📦	EAN
84-230	0/10	5907558424270

## Szczypce do pierścieni osadczych

Circlip pliers / Zange für Stellringe / Щипцы для стопорных колец / Щипці для стопорних кільць / Zégergyűrű fogókészlet / Set clește cu spirală / Klešče pro stavěcí kroužky / Segerky vonkajšie rovné / Klešče seger / Replės žiedams / Sprostgredzenu stangas / Vedurünipitsad / Клеци Зезеп / Kružna Klijesta / Kružna klesta / Ααφαλασταταιμίδες / Alicates para anillos de asiento / Set di pinze per anelli elastici / Pinças p. Anéis / Pince pour bagues de retenue / Tang voor dopringen

**NEO**  
TOOLS

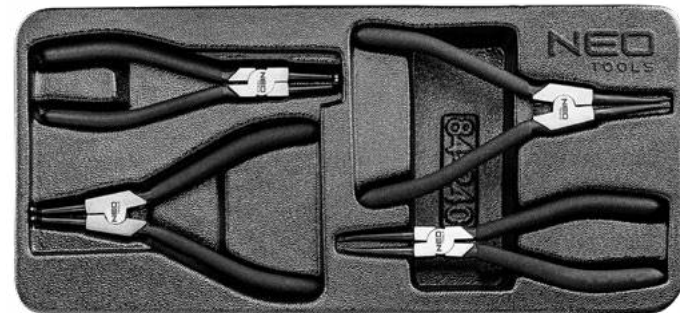

- 180 mm, zewnętrzne, proste / external, straight tip / щипцы для внешних/прямые
- 170 mm, zewnętrzne, wygięte / external, bent tip / щипцы для внешних/загнутые
- 180 mm, wewnętrzne, proste / internal, straight tip / щипцы для внутренних/прямые
- 170 mm, wewnętrzne, wygięte / internal, bent tip / щипцы для внутренних/загнутые



Ref.	📦	EAN
84-240	0/10	5907558424379

**NEO**  
TOOLS



Ref.	D [mm]	W [mm]	H [mm]	capacity [kg]	📦	EAN
84-404	420	660	835	75	0/1	5907558471625

## Zestaw narzędzi

Tools set / Werkzeugsatz / Набор инструментов / Набор інструментів / Szerszámkészlet / Set scule de grădini / Sada nářadí / Súprava nářadia / Garnitura ořodja / Įrankių komplektas / Instrumentu komplekts / Tööriistakomplekt / Геодре комплект / Set uredaja / Set alata / Συλλογή εργαλείων / Juego de herramientas / Set utensili / Kit de ferramentas / Jeu d'outils / Gereedschapset

**NEO**  
TOOLS

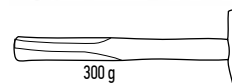

300 g



30 mm

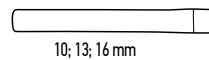

10; 13; 16 mm

Ref.	📦	EAN
84-242	0/10	5907558424393

## Pilniki

Files / Feilen / Напильники / Напилки / Reszelő készlet / Pile / Pilniki / Pilniki / Pile / Dildés / Viles / Viilid / Пилу / Турпје / Турпје / Лјец / Sopletes / Set di lime / Limas / Limes / Vijlen

**NEO**  
TOOLS

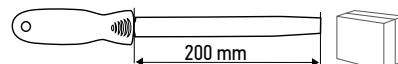
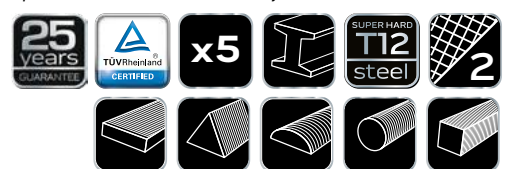

Ref.	📦	EAN
84-244	0/10	5907558424416



## Wkrętaki

Screwdriver set / Schraubendreher / Отвертки / Відкрутки, набір / Fogókészlet / Set şurubelnițe / Šroubováky / Súprava skrutkovačov / Garnitura izvijacaev / Atsuktuvai / Skrūvgriežu komplekts / Kruvikeerajate komplekt / Отвертки компл. / Odvijaci / Odvijac set / Συλλογή από καταβίδια / Destornilladores / Set giravite piatti / Chaves de fenda / Tournevis / Schroevendraaiers

**NEO**  
TOOLS



⊖ 3.0 x 75; 5.5 x 100; 5.5 x 200; 6.5 x 38;  
6.5 x 125; 6.5 x 150; 8.0 x 150 mm



Ref. 84-231 | EAN 0/10 5907558424287

**NEO**  
TOOLS



⊕ PH0 x 75 mm; PH1 x 75 mm; PH1 x 100 mm; PH2 x 38 mm;  
PH2 x 100 mm; PH2 x 150 mm; PH3 x 150 mm



Ref. 84-232 | EAN 0/10 5907558424294

**NEO**  
TOOLS



⊕ PH00; PH0; PH1 | ⊕ T10; T15; T20; T25  
⊕ PZ0; PZ1; PZ2 | ⊖ SL 2mm; SL 3mm



Ref. 84-247 | EAN 0/10 5907558424447

## Klucze nasadowe

Drive socket set / Steckschlüssel / Набор сменных головок / Ключи торцевые / Dugókulcskészlet / Trusa tubulara / Nástrčné kľúče / Nástrčné kľúče / Nasadni ključiči / Veržlerakció antgali / Nomainamo galvu komplekts / Padrunvõtmed / Сменными накрайници за ключове / Nasadni ključevci / Ključevni patikači / Set με καρδιάκια / Llaves de vaso / Set bussole / Chaves articuladas / Clefs à douilles / Dopsleutels

**NEO**  
TOOLS

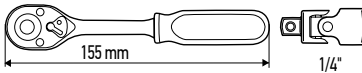
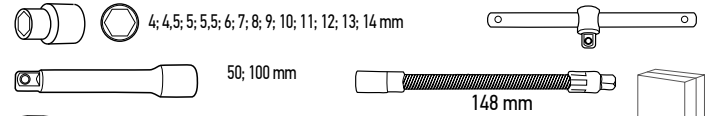

Ref. 84-237 | EAN 0/10 5907558424348

**NEO**  
TOOLS

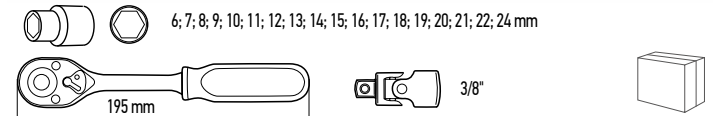

Ref. 84-239 | EAN 0/10 5907558424362

**NEO**  
TOOLS

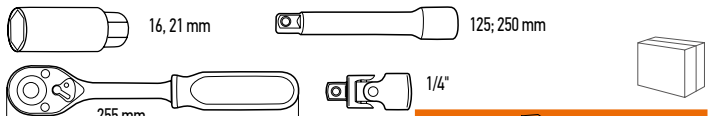
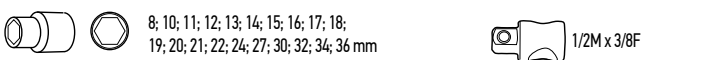

Ref. 84-238 | EAN 0/6 5907558424355



## Nasadki udarowe

Impact sockets / Schlagaufsätze / Насадки ударные / Патрони перфораторни / Gépi dugókulcs készlet / Brütare percutante / Prikleponé nástavce / Prikleponé nástavce / Udarni nasadni ključ / Kalimo antgaliai / Triecienuzgāji / Löökotsakud / Ударни наставкаи / Udarni nasadni nastavci / Udarne kapice / Υποδοχές κρουστικής ανταλλακτικής / Llaves de vaso para atornilladores de impacto / Set bussole a percussione / Bocais de impacto / Douilles de choc / Slagdoppen

**NEO**  
TOOLS



10; 12; 13; 14; 16; 17; 19; 21; 22; 24 mm  
10; 12; 13; 14; 16; 17; 19; 21; 22; 24 mm

Ref. 84-241 | EAN 5907558424386

## Nasadki sześciokątne długie

Hexagonal sockets / Sechskantaufsätze / Головки сменные шестигранные / Насадки шестигранни / Dugókulcs hosszú készlet / Capete tubulare hexagonale / Šestihranné nástavce / Šesthranné nástavce / Šestkotni nasadni ključ / Šešiakampiai antgaliai / Sešstūra nomaināmais galvas / Kuuskantpadrunid / Шестугольные наставкаи / Šesterokutne kapice / Šestougaone nasadke / Καρυδιάκια εξήγωνα / Vasos hexagonales / Set bussole / Bocais hexagonais / Douilles à 6 pans / Zeskant doppen

**NEO**  
TOOLS



8, 9, 10, 11, 12, 13, 14, 15, 16, 17, 18, 19, 20, 21 mm

Ref. 84-243 | EAN 5907558424409

## Końcówki wkrętaskowe

Driver bits / Einsätze für Schraubendreher / Насадки / Наконечники викрүткови / Bitkészlet / Set biti / Šroubovákonné nástavce / Skrutkovacie nástavce / Nastavki za izvijače / Atsuktuvo antgaliai / Skrivgrieža uzgāji / Kruvikeerajaotsakud / Накариўниця за отвёртка / Nastavci za odvijač / Nastavci za odvijač / Κατασβιδόμενες / Puntas destornilladoras / Set inserti / Ponteiros chave de fenda / Embouts de tournevis / Schroevendraaierendstukken

**NEO**  
TOOLS

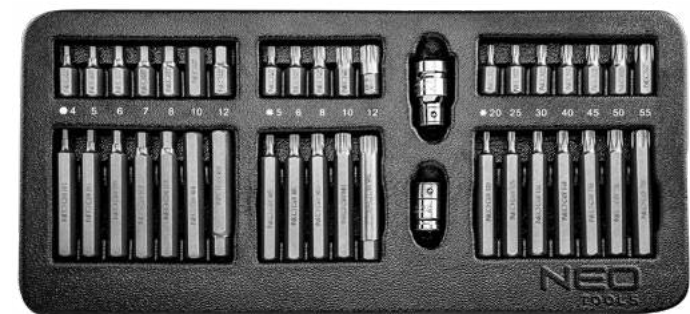

H4; H5; H6; H7; H8; H10; H12  
M5; M6; M8; M10; M12  
T20; T25; T30; T40; T45; T50; T55  
H4; H5; H6; H7; H8; H10; H12  
M5; M6; M8; M10; M12  
T20; T25; T30; T40; T45; T50; T55

75 mm | 30 mm | Ref. 84-236 | EAN 5907558424331

## Klucze płasko-oczkowe

Ratchet wrench set / Maul-Ringschlüssel / Ключи комбинированные / Ключи ріжково-накидні, набір / Csillag-villáskulcs készlet / Set chei cu clichet / Očkolpoché klíče / Súprava OP račkových klíčův / Ključ vilicasto-obročni / Raktas plokščias - kilpinis / Kombinēto atslēgu komplekts / Pörkmutrivõtmete komplekt / Ключ звездозагачен / Set ključeva / Ključ kombinovani / Συλλογή πολυγώνων καστανιός / Llaves combinadas (de estrella y a carraca abierta) / Set chiavi combinate / Chaves planas-de luneta / Clefs à fourche polygonales / Moersleutels

**NEO**  
TOOLS

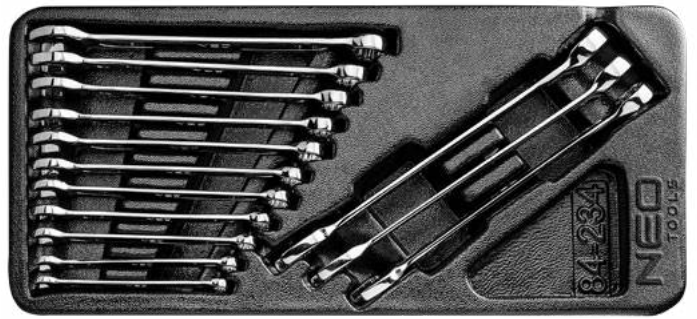

6x100; 7x110; 8x120; 9x130; 10x140; 11x150; 12x160; 13x170; 14x180; 15x190; 16x200; 17x210; 18x220; 19x230 mm

Ref. 84-234 | EAN 5907558424317

**NEO**  
TOOLS

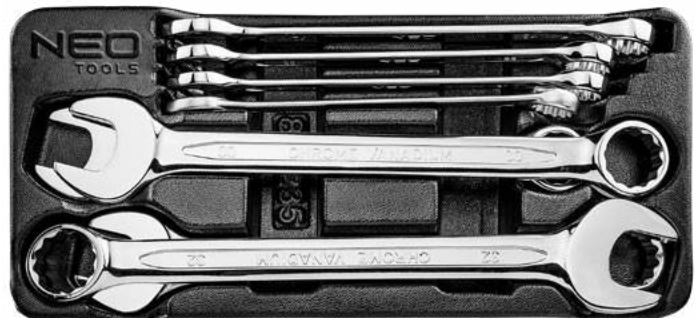

20x240; 21x250; 22x260; 24x280; 27x310; 29x340; 30x340; 32x360 mm

Ref. 84-235 | EAN 5907558424324

## Klucze oczkowe odgięte

Offset ring spanner set / Ringschlüssel gebogen / Ключи накидные коленачатые / Ключи накидні колінчасті, набір / Csillagkulcs készlet / Set chei inelare de deviație / Očkový klíč vyhnutý / Súprava očkových klíčův / Garnitura obročnih ključev, uprogjenih / Kilpinii, lenktų raktų komplektas / Kombinēto izliekto atslēgu komplekts / "Ofset" mutrivõtmete komplekt / Ключ лунга / Ključ okasti / Ključ okasti set / Συλλογή κυρτών πολυγώνων κλειδιών με κεκλιμένη κεφαλή / Llaves de estrella, acodadas / Set chiavi inclinate ad anello / Chaves de luneta curvadas / Clefs polygonales contre-coudées / Gebogen ringsleutels

**NEO**  
TOOLS



6x7; 8x9; 10x11; 12x13; 14x15; 16x17; 18x19; 20x22 mm

Ref. 84-233 | EAN 5907558424300





## Narzynki i gwintowniki

Tap and die set / Schneideisen und Gewindebohrer / Плашки и метчики / Позначники и плашки, набір / Menekészítő készlet / Set scule tăiere filet interior și exterior / Závítnice a závitníky / Súprava závitníkov / Garnitura vreznikov in nareznikov navoja / Sriegpjovēs ir sriegikļi / Vītņgriežu komplekts / Kraani ja valuvormi komplekt / Метчици и плашки / Nareznice i ureznicne set / Set ureznika i nareznika / Ελικοκόφτες και κολλούζα / Cojinetes y machos de roscar, juego / Set di filiere a maschi / Cassonetes e roscas / Filières et tarauds / Snijplaat en schroefdraad snijtoestel

NEO  
TOOLS

25  
years  
GUARANTEED

TÜV Rheinland  
CERTIFIED

HSS  
steel

x31

DIN  
352

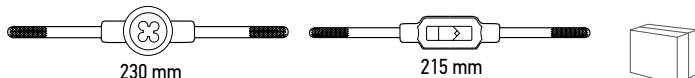
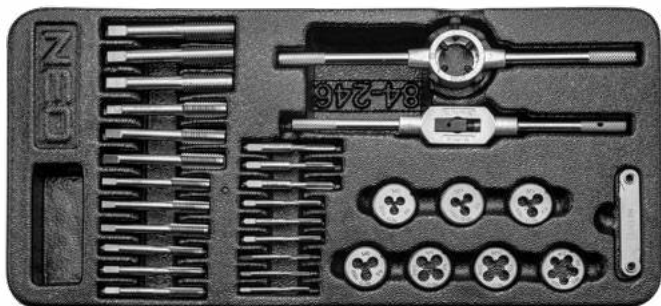

M3; M4; M5; M6; M8; M10; M12 - 25 x 9 mm

3xM3; 3xM4; 3xM5; 3xM6;  
3xM8; 3xM10; 3xM12

Ref.	📦	EAN
84-246	0/10	5907558424430

## Uchwyt na papier

Paper sheet holder / Papierhalter / Держатель для бумаги / Тримач для паперу / Papírtartó / Suport pentru hârtie / Držák na papír / Držák na papír / Držalo za papir / Popieraus laikiklis / Papīra turētājs / Paberhoidik / Postavka za hartija / Držač za papir / Držač za papir / Βάση χαρτί / Portapapeles / Portacarta / Suporte de papel / Poignée pour papier

NEO  
TOOLS



1mm  
COLD  
STEEL  
ADAPTER  
INCLUDED

Ref.	📦	EAN
84-271	0/10	5907558481617

## Kosz na śmieci

Dust bin / Papierkorb / Корзина для мусора / Смітник / Szemétkosár / Coș de gunoi / Odpadkový koš / Smetný koš / Koš za smeti / Šiukšlių dėžė / Atkritumu grozis / Prügikorv / Кош за отпадцы / Košarica za smeće / Kanta za smeće / Καλάθι απορριμάτων / Cubo de basura / Cestino della spazzatura / Caixaote de lixo / Poubelle

NEO  
TOOLS



1mm  
COLD  
STEEL

5.5L

250x  
68x  
250mm

Ref.	📦	EAN
84-274	0/4	5907558481624

## Wkład profilowany

Profiled insert / Profileinsatz / Профилированный вставной элемент / Оранжейзер / Tároló rekeszes tábla / Cartuş profilat / Profilovaná vložka / Profilovaná vložka / Profiliran vložek / Profiluotas įdėklas / Profiliēts ieliekamais elements / Profilitud tihend / Профилен элемент / Profilirani umetak / Profilirani umetak / Διαίρητο ένθετο εξάρτημα / Bandeja clasificadora perfilada / Vassoio / Cartuco perfilado / Cilindre profilé / Geprofileerde inzetdeel

NEO  
TOOLS

25  
years  
GUARANTEED

FULL  
DRAWER

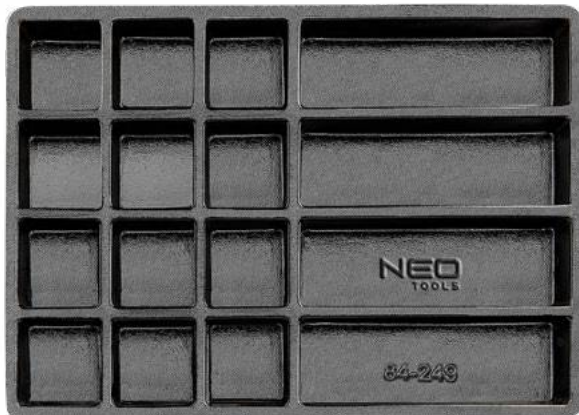

550x386 mm

Ref.	📦	EAN
84-249	0/5	5907558424461

## Szafka serwisowa 4 szuflady (nadstawka)

Service cabinet 4 drawers (extension) / Serviceschrank 4 Schubladen (Erweiterung) / Шкаф для обслуживания 4 ящиков (верхний блок) / Службово шафа 4 висувних ящиків / Szervizszekrény 4 fiókkal (felső egység) / Dulap de service 4 sertare (extensie) / Servisní skříňka 4 zásuvek (prodloužení) / Servisná skrinka 4 zásuvek (výsuv) / Servisna omara 4 predalov (podaljšek) / Aptarnavimo spinta 4 stalčiai (prailginimas) / Apkalpošanas skapis 4 atvilktnes (pagarinājums) / Teeninduskapp 4 sahtlit (pikendus) / Serviszen шкаф 4 чекмеджета (удължение) / Servisni ormar 4 ladica (produžetak) / Сервисни ормар 4 фиока (продужетак) / Σέρβις 4 αυτιάρια (επέκταση) / Armario de servicio 4 cajones (extensión) / Mobile di servizio 4 cassettei (allunga) / Gabinete de serviço 4 gavetas (extensão) / Armoire de service 4 tiroirs (extension) / Servicekast 4 lades (uitbouw)

NEO  
TOOLS

for  
84-221  
84-222



Ref.	D [mm]	W [mm]	H [mm]	📦	EAN
84-218	420	670	450	0/1	5907558484588



## Szafka narzędziowa

Tool cabinet / Werkzeugschrank / Шкафчик для инструментов / Шафа інструментальна / Műhelykocsi / Dulap pentru scule / Skříňka na nářadí / Skrinka na náradie / Omatrica za orodje / Įrankių spintelė / Instrumentu skapis / Tööriistakapp / Шкафче за инструменти / Ormar za alate / Ormaric za alatke / Ντουλαράκι για εργαλεία / Armario de almacenaje para herramientas / Carrello porta utensili / Estante p. Ferramentas / Rmoire à outils / Gereedschapskast

**T TOPEX**

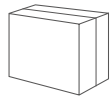
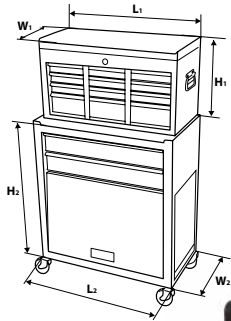

Ref.	L1 [cm]	L2 [cm]	W1 [cm]	W2 [cm]	H1 [cm]	H2 [cm]	☒	EAN
79R500	60,0	61,5	26,0	33,0	34,0	66	0/1	5902062795007

**T TOPEX**

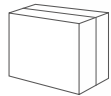

Ref.	D [mm]	W [mm]	H [mm]	capacity [kg]	☒	EAN
79R501	460	680	825	280	0/1	5902062035783

**T TOPEX**



1 szuflada / drawer / ящик



2 szuflada / drawer / ящик



3 szuflada / drawer / ящик



105 tools + 350 accessories

**455 elements**

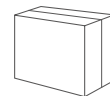

Ref.	D [mm]	W [mm]	H [mm]	capacity [kg]	☒	EAN
79R502	460	680	825	280	0/1	5902062036582



## Szczypce

Drive socket set / Steckschlüssel / Набор сменных головок / Ключи торцевые / Fogóköszlet / Trusa tubulare / Nástrčné kľúče / Nástrčné kľúče / Nasadni ključji / Veržlerakcio antgaliai / Normaināmo galvu komplekts / Padrīnviõtmēd / Сменяемыми наконечниками за ключом / Nasadni ključevni / Ključevni natikači / Σετ με καριδάκια / Llaves de vaso / Set pinze / Chaves articuladas / Clefs à douilles / Dopsleutels

**TOPEX**

x5

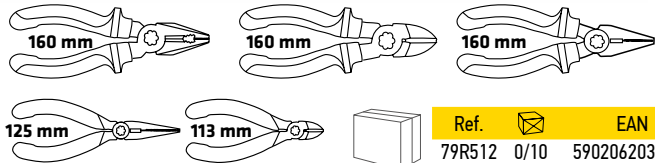
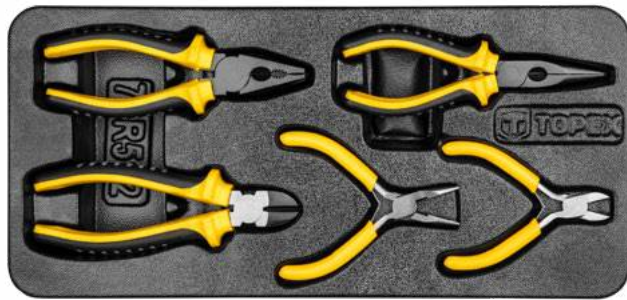

Ref. 79R512 0/10 EAN 5902062035530

## Klucze nasadowe

Drive socket set / Steckschlüssel / Набор сменных головок / Ключи торцевые / Dugókulcskészlet / Trusa tubulare / Nástrčné kľúče / Nástrčné kľúče / Nasadni ključji / Veržlerakcio antgaliai / Normaināmo galvu komplekts / Padrīnviõtmēd / Сменяемыми наконечниками за ключом / Nasadni ključevni / Ključevni natikači / Σετ με καριδάκια / Llaves de vaso / Set utensili / Chaves articuladas / Clefs à douilles / Dopsleutels

**TOPEX**

CrV

x21

1/2"

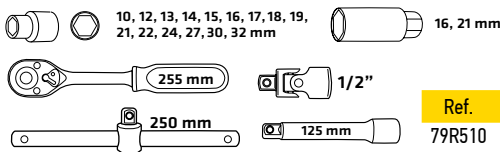

Ref. 79R510 0/6 EAN 5902062035592

## Klucze nasadowe

Drive socket set / Steckschlüssel / Набор сменных головок / Ключи торцевые / Dugókulcskészlet / Trusa tubulare / Nástrčné kľúče / Nástrčné kľúče / Nasadni ključji / Veržlerakcio antgaliai / Normaināmo galvu komplekts / Padrīnviõtmēd / Сменяемыми наконечниками за ключом / Nasadni ključevni / Ključevni natikači / Σετ με καριδάκια / Llaves de vaso / Set utensili / Chaves articuladas / Clefs à douilles / Dopsleutels

**TOPEX**

CrV

x21

1/4"

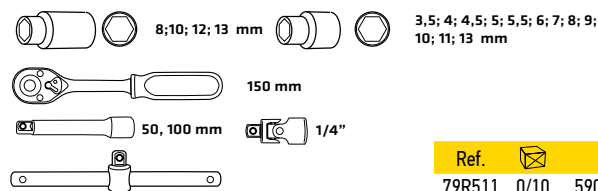

Ref. 79R511 0/10 EAN 5902062035585

## Wkrętaki

Screwdriver set / Schraubendreher / Отвертки / Відкритки, набір / Csavarhúzókészlet / Set šurubelnice / Šraubováký / Sada skrutkovačov / Komplet izvijačev / Atsuktuvų komplektas / Skrivn griežu komplekts / Kruvikeerajate komplekt / Отвертки компл. / Odvijajući set / Odvijac set / Συλλογή καταβιδιών / Destornilladores / Set giraviti / Chaves de fenda / Tournevis

**TOPEX**

CrV

x6



- 3.2 x 75 mm
- 4.0 x 100 mm
- 5.0 x 38 mm
- 5.0 x 100 mm
- 6.5 x 100 mm
- 8.0 x 150 mm

Ref. 79R513 0/10 EAN 5902062035547

**TOPEX**

CrV

x6



- PH0 x 75 mm
- PH1 x 100 mm
- PH2 x 38 mm
- PH2 x 100 mm
- PH2 x 150 mm
- PH3 x 150 mm

Ref. 79R514 0/10 EAN 5902062035554

## Zestaw narzędzi

Tools set / Werkzeugsatz / Набор инструментов / Набор инструментов / Szerszámkészlet / Set scule de grădini / Sada náradí / Súprava náradia / Garnitura orodja / Įrankių komplektas / Instrumentu komplekts / Тööriistakomplekt / Набор инструментов / Set uredaja / Set alata / Συλλογή εργαλείων / Juego de herramientas / Set utensili / Kit de ferramentas / Jeu d'outils / Gereedschapset

**TOPEX**

CrV

x29



- T10, T15, T20, T25, T27, T30, T40, T45, T50
- 1/2" 10, 13, 16, 17, 19, 24 mm
- P21, P22, P23, P24
- H3, H4, H5, H6, H7, H8
- M5, M6, M8, M10

Ref. 79R515 0/10 EAN 5902062035561



## Klucze płasko-oczkowe

Ratchet wrench set / Maul-Ringschlüssel / Ключи комбинированные / Ключи ріжково-накидні, набір / Csillag-villáskulcs készlet / Set chei cu clichet / Očkoploché klúče / Súprava DP račňových klúčov / Ključ viličasto-obročni / Raktas plokščias - kilpinis / Kombinēto atslēgu komplekts / Põrkmutrivõtmete komplekt / Ключ звездогоачен / Set ključeva / Ključ kombinovani / Συλλογή πολυγώνων καστανιάς / Llaves combinadas (de estrella y a carraca abierta) / Set chiavi combinate / Chaves planas-de luneta / Clefs à fourche polygonales / Moersleutels

**TOPEX**

**CrV x14**

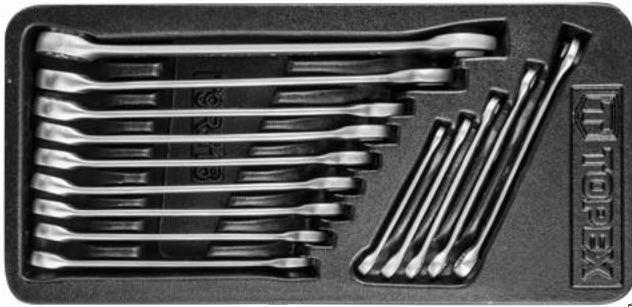

6 x 100, 7 x 100, 8 x 110, 10 x 125,  
12 x 140, 13 x 145, 14 x 160, 15 x 175,  
16 x 185, 17 x 205, 18 x 205, 19 x 230,  
22 x 260, 24 x 280 mm

Ref. EAN  
79R516 0/10 5902062035578

## Młotki

Hammer / Hammer / Молоток / Молоток / Kalapács készlet / Ciocan / Kladívko / Kladivo / Kladivce / Plaktukas / Āmurs / Vasar / Чук / Čekić / Čekić / Σφυρί / Martillo / Set martelli / Martelo / Martelet / Hamer

**TOPEX**

**x2**

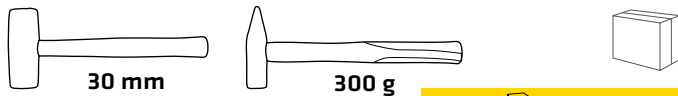

Ref. EAN  
79R517 0/10 5902062035608

## Nitownica

Riveter / Nietmaschine / Заклепочник / Клепальный инструмент / Popszegecs húzó / Mašinà de nituit / Nýtovačka / Kliešte nitovacie ocelové / Pištolà za kovljeenje / Kniediklis / Kniežu stangas / Needitangid / Нитачка / Klijesta za zakovice / Pistolj za rop nitne / Ηλοι / Remachadora / Set rivettatrice e rivetti / Rebitadora / Riveuse / Klinknagelmaschine

**TOPEX**

**AI**



3.2 x 8 mm, 50 szt.,  
4.0 x 10 mm, 50 szt.,  
4.0 x 12.5 mm, 50 szt.,  
4.8 x 10 mm, 50 szt.,  
4.8 x 12.5 mm, 50 szt.

Ref. EAN  
79R518 0/10 5902062035615

## Haki

Hooks / Hacken / Крюки / Гаки / Horgok / Cârlige / Háký / Skoby / Kljuke / Kabliai / Āķi / Haagid / Кукы / Kuke / Kuke / Γάντζοι / Ganchos / Ganci / Anzais / Crochets / Haken

**NEO TOOLS**

**x3 40 mm**  
for 84-500 84-501

Ref.	L [mm]		EAN
84-096	40	0/65	5907558439267

**NEO TOOLS**

**x5 85 mm**  
for 84-500 84-501

Ref.	L [mm]		EAN
84-097	85	0/50	5907558439274

**NEO TOOLS**

**x5 40 mm**  
for 84-500 84-501

Ref.	L [mm]		EAN
84-095	40	0/100	5907558439250

**NEO TOOLS**

for 84-500 84-501

Ref.		EAN
84-092	8/40	5907558439151

**NEO TOOLS**

for 84-500 84-501

Ref.		EAN
84-093	0/100	5907558439168

**NEO TOOLS**

for 84-500 84-501

Ref.		EAN
84-094	0/50	5907558439175

**NEO TOOLS**

for 84-500 84-501

Ref.		EAN
84-098	0/100	5907558442526



## Klucze nasadowe

Socket wrenches / Steckschlüssel / Набор сменных головок / Ключи торцови / Dugókulcskészlet / Trusa tubulare / Nástrčné kľúče / Nástrčné kľúče / Nasadni ključji / Verzlérakció antgajai / Nomaināmo galvu komplekts / Padrinvõtmed / Сменная накрайница за ключове / Nasadni ključevci / Ključevci natičasti / Set me karubáka / Llaves de vaso / Set di bussole SuperLock / Chaves tubulares / Clefs à douilles / Dopsleutels

**NEO**  
TOOLS

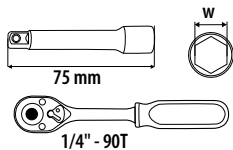

Ref.	W[mm]	⊠	EAN
10-000	4, 4.5, 5, 5.5, 6, 7, 8, 9, 10, 11, 12, 13	5/20	5907558466133

**NEO**  
TOOLS

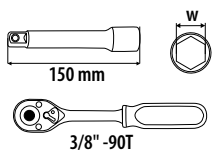

Ref.	W[mm]	⊠	EAN
10-020	8, 10, 12, 13, 14, 16, 17, 19, 21, 22	5/10	5907558466157

**NEO**  
TOOLS

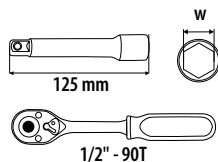

Ref.	W[mm]	⊠	EAN
10-030	8, 10, 12, 13, 14, 16, 17, 19, 21, 22	4/12	5907558466126

**NEO**  
TOOLS

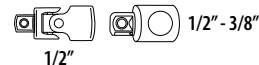
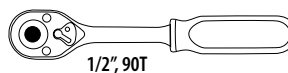
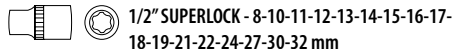

Ref.	⊠	EAN
08-694	1/5	5907558440034

**NEO**  
TOOLS

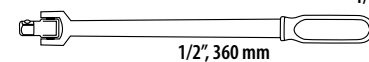
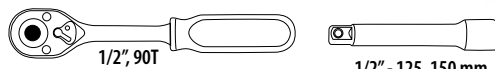
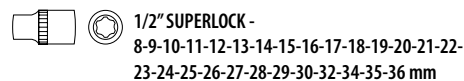

Ref.	⊠	EAN
08-692	1/4	5907558440034



## Klucze nasadowe

Socket wrenches / Steckschlüssel / Набор сменных головок / Ключи торцевой / Dugókulcskészlet / Trusa tubulara / Nástrčné kľúče / Nástrčné klúče / Nasadni ključiči / Veržlerákció antgajai / Nomināmo galvu komplekts / Padrunvõtmed / Сменными наконечниками для ключов / Nasadni ključevci / Ključevci natičaki / Σετ με καρυδάκια / Llaves de vaso / Set di bussole SuperLock / Chaves tubulares / Clefs à douilles / Dopsleutels

**NEO**  
TOOLS



1/2" SPLINE - 10-11-12-13-14-15-16-17-18-19-20-21-22-23  
-24-27-30-32 mm

1/4" SPLINE - 4-4.5-5-5.5-6-7-8-9-10-11-12-13 mm

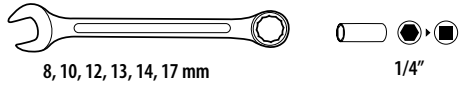
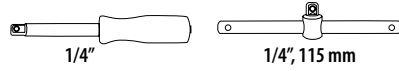

1/4 - TT - 10-15-20-25-27-30-40  
PZ - 1-2-3  
PH - 1-2-3  
SL - 4.5-6.5-8 mm  
HEX - 3-4-5-6-7-8 mm

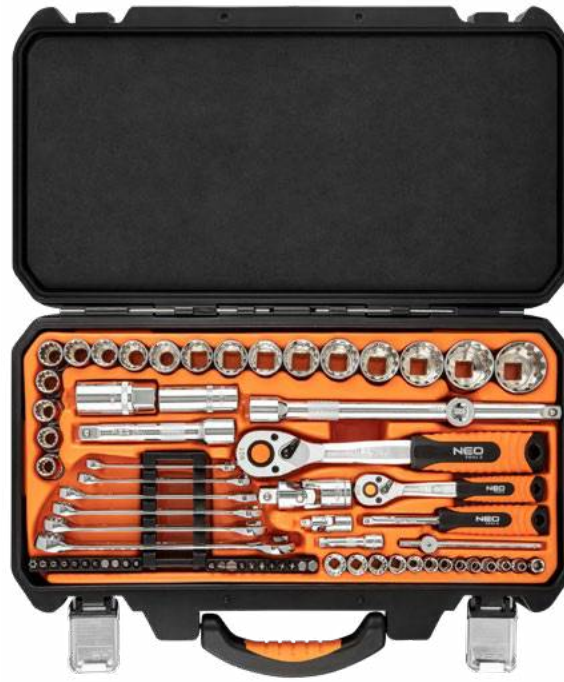

Ref. 08-690 EAN 0/10 5907558440010

**NEO**  
TOOLS



1/4" - 4-4.5-5-5.5-6-7-8-9-10-11-12-13-14 mm

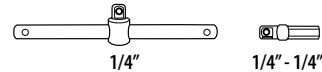

1/4 - SL - 4, 5, 5, 7  
PH - 1-2-3  
PZ - 1-2-3  
T - 10-15-20-25-30-40  
HEX - 3-4-5-6-7-8

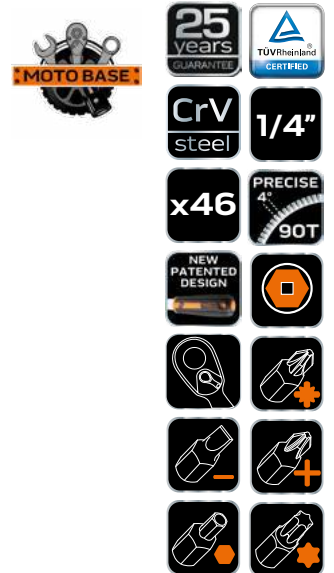
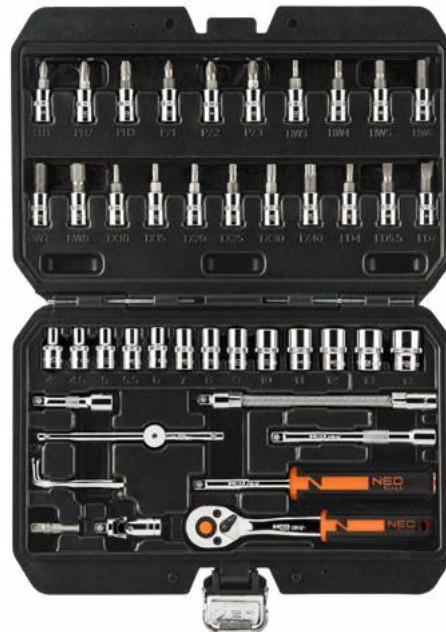

Ref. 10-004 EAN 1/10 5907558465945

**NEO**  
TOOLS

1/4" - 4-4.5-5-5.5-6-7-8-9-10-11-12-13-14 mm

1/4" - 6-7-8-10-11-12-13 mm

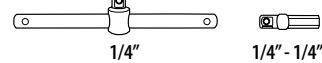

1/4 - SL - 4, 5, 5, 7  
PH - 1-2-3  
PZ - 1-2-3  
T - 10-15-20-25-30-40  
HEX - 3-4-5-6-7-8



Ref. 10-006 EAN 1/10 5907558466119



## Klucze nasadowe

Socket wrenches / Steckschlüssel / Набор сменных головок / Ключи торцевой / Dugókulcskészlet / Trusa tubulare / Nástrčné kľúče / Nástrčné kľúče / Nasadni ključevi / Veržlerakció antgatalai / Nomaināmo galvu komplekts / Padrunvõtmed / Сменная накрайница за ключове / Nasadni ključevi / Ključevi natiakači / Σετ με καρδιάκια / Llaves de vaso / Set di bussolle SuperLock / Chaves tubulares / Clefs à douilles / Dopsleutels

**NEO**  
TOOLS



1/2" - 10-11-12-13-14-15-16-17-18-19-20-  
21-22-23-24-27-30-32 mm

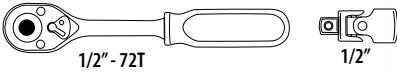

1/2" - 72T

1/2"

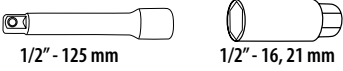

1/2" - 125 mm

1/2" - 16, 21 mm

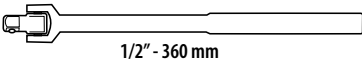

1/2" - 360 mm

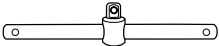

1/2" - 250 mm

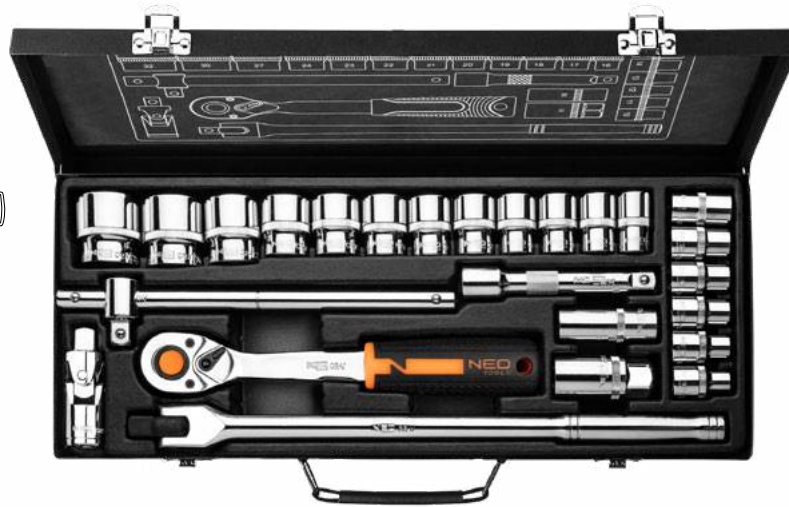

25 years  
GUARANTEE



CrV  
steel

1/2"

x25

PRECISE  
4°  
90T

NEW  
PATENTED  
DESIGN



Ref. 10-036 EAN 1/4 5907558466058

**NEO**  
TOOLS



3/4" - 19-21-22-23-24-26-27-29-  
30-32-35-36-38-41-46-50 mm

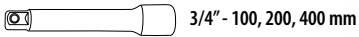

3/4" - 100, 200, 400 mm

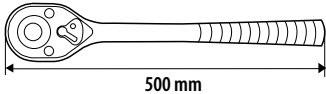

500 mm

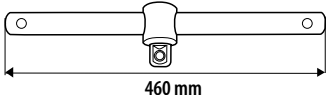

460 mm



25 years  
GUARANTEE



CrV  
steel

x21

3/4"

24



Ref. 08-061 EAN 0/1 5907558404173

**NEO**  
TOOLS



1/4" - 4-4.5-5-5.5-6-7-8-9  
-10-11-12-13-14 mm

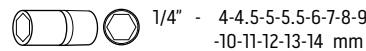

1/4" - 4-4.5-5-5.5-6-7-8-9  
-10-11-12-13-14 mm

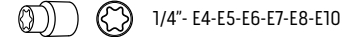

1/4" - E4-E5-E6-E7-E8-E10

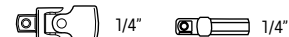

1/4"

1/4"

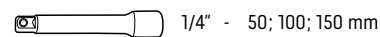

1/4" - 50; 100; 150 mm



1/4"



1/4", 140 mm



1/4"

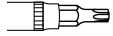

1/4" - TX - 8-10-15-20-25-30-40  
PH - 1-2-3  
PZ - 1-2-3  
SL - 4-5.5-7 mm  
HEX - 3-4-5-6-7-8 mm



25 years  
GUARANTEE

CrV  
steel

x63

1/4"

PRECISE  
4°  
90T

NEW  
PATENTED  
DESIGN



Ref. 10-008 EAN 5/10 5907558466003



## Klucze nasadowe

Socket wrenches / Steckschlüssel / Набор сменных головок / Ключи торцевые / Dugókulcskészlet / Trusa tubulare / Nástrčné kľúče / Nástrčné kľúče / Nasadni ključiči / Veržlerakció antgaliái / Nomaināmo galvu komplekts / Padrūnīvotmed / Сменная накрайница за ключове / Nasadni ključeviči / Ključeviči natičaki / Σετ με καρδιάκια / Llaves de vaso / Set di bussolle SuperLock / Chaves tubulares / Clefs à douilles / Dopsleutels

**NEO**  
TOOLS



1/2" - 10-11-12-13-14-15-16-17-18-19-22-24 mm



1/2" - 16 mm

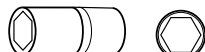

1/2" - 13-17-19 mm



1/2"

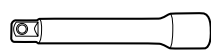

1/2" - 250 mm



1/2"



1/2"



25  
years  
GUARANTEE

CrV  
steel



x20

1/2"

PRECISE  
4°  
90T

NEW  
PATENTED  
DESIGN



Ref. EAN  
10-032 1/5 5907558466140

**NEO**  
TOOLS

1/2" - 8 - 9 - 10 - 11 - 12 - 13 - 14 -  
15 - 16 - 17 - 18 - 19 - 20 - 21 -  
22 - 24 - 27 - 30 - 32 mm

1/2" - 10-12-14-15-17-19 mm

1/2" - 16, 21 mm

1/2"

1/2" - 125, 250 mm

1/2"

1/2"



25  
years  
GUARANTEE



CrV  
steel

x32

1/2"

PRECISE  
4°  
90T

NEW  
PATENTED  
DESIGN



Ref. EAN  
10-038 1/5 5907558466096





## Klucze nasadowe

Socket wrenches / Steckschlüssel / Набор сменных головок / Ключи торцевые / Dugókulcskészlet / Trusa tubulare / Nástrčné kľúče / Nástrčné ključice / Nasadni ključiči / Veržlerakció antgátiai / Nomināmo galvu komplekts / Padrūnviņtmed / Сменная накрайница за ключове / Nasadni ključevci / Ključevci natičaki / Σετ με καρυδάκια / Llaves de vaso / Set di bussole SuperLock / Chaves tubulares / Clefs à douilles / Dopsleutels

**NEO**  
TOOLS



1/2" - 10-11-12-13-14-15-16-17-18-19-20-21-22-24-27-30-32 mm

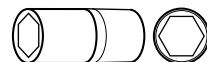

1/2" - 10-11-12-13-14-15-17-19 mm



1/2" - 16, 21 mm



1/2"



1/2" - 125, 250 mm



1/2"

1/2"



1/2" - 5/16"

5/16" - FD8-FD10-FD12

PH1-PH2-PH3-PH4

PZ1-PZ2-PZ3-PZ4

T20-T25-T30-T40-T45-T50-T55

H4-H5-H6-H8-H10-H12-H14



Ref. 10-042  
EAN 5907558466072



**NEO**  
TOOLS

1/4" - 14-15-16-17-18-19-20-22-24-27-30-32 mm  
1/4" - 4-4.5-5-5.5-6-7-8-9-10-11-12-13-14 mm

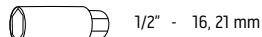

1/4" - 16, 21 mm



1/4" - 90T  
1/4" - 90T



1/4" - 150 mm



1/4" - 150 mm

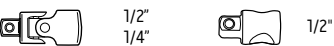

1/2" 1/4" 1/2"



1/2" - 125, 250 mm  
1/4" - 50, 100 mm

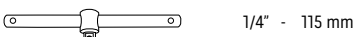

1/4" - 115 mm

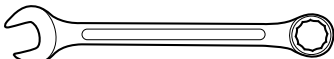

8-10-11-12-13-14-17-19-22 mm



1/2" - 5/16"

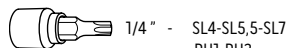

1/4" - SL4-SL5.5-SL7  
PH1-PH2  
PZ1-PZ2

T8-T10-T15-T20-T25-T30

H3-H4-H5-H6

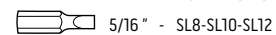

5/16" - SL8-SL10-SL12  
PH3-PH4  
PZ3-PZ4

T40-T45-T50-T55

H8-H10-H12-H14

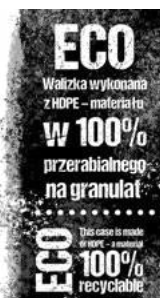

Ref. 10-058  
EAN 5907558465921



## Klucze nasadowe

Socket wrenches / Steckschlüssel / Набор сменных головок / Ключи торцевые / Dugókulcskészlet / Trusa tubulare / Nástrčné kľúče / Nástrčné kľúče / Nasadni ključji / Veržlerakció antgaliak / Nomaināmo galvu komplekts / Padrinvõtmed / Сменная накрайница за ключове / Nasadni ključevci / Ključevci natičaki / Σετ με καρδιάκια / Llaves de vaso / Set di bussolle SuperLock / Chaves tubulares / Clefs à douilles / Dopsleutel

**NEO**  
TOOLS



1/2" - 14-15-16-17-18-19-20-22-24-27-30-32 mm  
1/4" - 4-4.5-5-5.5-6-7-8-9-10-11-12-13-14 mm



1/2" - 16, 21 mm

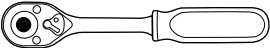

1/2" - 90T  
1/4" - 90T

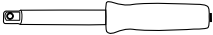

1/4" - 150 mm



1/4" - 150 mm



1/2"  
1/4"



1/2"

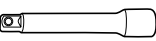

1/2" - 125, 250 mm  
1/4" - 50, 100 mm

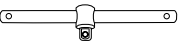

1/4" - 115 mm

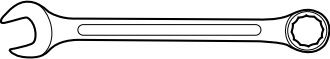

8-10-11-12-13-14-17-19-22 mm



1/2" - 5/16"

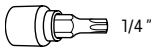

1/4" - SL4-SL5,5-SL7  
PH1-PH2  
PZ1-PZ2  
T8-T10-T15-T20-T25-T30  
H3-H4-H5-H6



5/16" - SL8-SL10-SL12  
PH3-PH4  
PZ3-PZ4  
T40-T45-T50-T55  
H8-H10-H12-H14



Ref. 10-059 EAN 5907558487695

**NEO**  
TOOLS

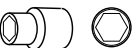

1/2" - 10-11-12-13-14-15-16-17-18-19  
20-21-22-23-24-27 mm  
1/4" - 4-5-5.5-6-7-8-10-11-12-13 mm

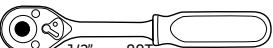

1/2" - 90T  
1/4" - 90T



1/2" 1/2"



1/2" - 16, 21 mm

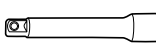

1/2" - 125, 250 mm  
1/4" - 100 mm

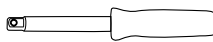

1/4" - 150 mm



1/4"

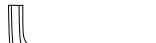

1,5-2-2,5 mm



1/4" - TX8, TX10, TX15, TX20, TX25, TX27,  
TX30, TX40, PH0, PH1, PH2, PH3,  
PZ1, PZ2, PZ3, SL4, SL5,5, SL7, HEX 3,  
4, 5, 6, 8, 10, 1/8", 9/64", 5/32",  
3/16", 7/32", 1/4", 5/16", SPLINE 6, 8





Ref. 10-054 EAN 5907558465938







## Klucze nasadowe

Socket wrenches / Steckschlüssel / Набор сменных головок / Ключи торцевые / Dugókulcskészlet / Trusa tubulara / Nástrčné kľúče / Nástrčné ključice / Nasadni ključiči / Veržlerakció antgátiai / Nomināmo galvu komplekts / Padrinvõtmed / Сменная накрайница за ключове / Nasadni ključevci / Ključevci natičasti / Σετ με καρβύδια / Llaves de vaso / Set di bussole SuperLock / Chaves tubulares / Clefs à douilles / Dopsleutel

**NEO**  
TOOLS

  1/2" - 10-13-15-16-17-18-19-20-21  
-22-23-24-27-30-32 mm

  1/4" - 4-4.5-5-5.5-6-6.5-7-8-9  
-10-11-12-13-14 mm

  1/2" - 14-15-17-19 mm  
1/4" - 6-7-8-9-10-11-12-13 mm

 1/2"  
1/4"

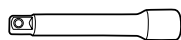

1/2" - 125, 250 mm  
1/4" - 50, 100 mm

 1/2"  
1/4"



1/2" - 16, 21 mm



1/4" - 150 mm

 1/4"

  1/2" - 5/16"

 1/4" - TX8-TX10-TX15-TX20  
TX25-TX30  
PH1-PH2  
PZ1-PZ2  
FD4-FD5.5-FD7  
H3-H4-H5-H6

 5/16" - TX40-TX45-TX50-TX55  
PH3-PH4  
PZ3-PZ4  
FD8-FD10-FD12  
H8-H10-H12-H14



25 years  
GUARANTEE



CrV  
steel

x86

1/2"

1/4"



PRECISE  
4°  
90T



NEW  
PATENTED  
DESIGN





Ref.  EAN  
10-060 1/4 5907558465976

**NEO**  
TOOLS

  1/2" - 10-11-12-13-14-15-16-17-18-19  
-20-21-22-23-24-27-30-32 mm

  1/4" - 4-4.5-5-5.5-6-7-8-9-10  
-11-12-13-14 mm

  1/2" - 14-15-17-19 mm  
1/4" - 6-7-8-9-10-11-12-13 mm

 1/2"  
1/4"

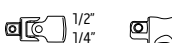
 1/2"  
1/4"

 1/2" - 125, 250 mm  
1/4" - 50, 100 mm

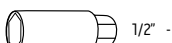
 1/2" - 16, 21 mm

 1/4"

 1/4" - 150 mm



 1/4" - 150 mm

 1/4" - SL4-SL5.5-SL7  
PH1-PH2  
PZ1-PZ2  
T8-T10-T15-T20-T25-T30  
H3-H4-H5-H6

 5/16" - SL8-SL10-SL12  
PH3-PH4  
PZ3-PZ4  
T40-T45-T50-T55  
H8-H10-H12-H14

 1.5-2-2.5 mm

 1/4" - 1/4"

  1/2" - 5/16"



25 years  
GUARANTEE



CrV  
steel

x94

1/2"

1/4"

PRECISE  
4°  
90T

NEW  
PATENTED  
DESIGN



Ref.  EAN  
10-062 1/4 5907558465952



## Klucze nasadowe

Socket wrenches / Steckschlüssel / Набор сменных головок / Ключи торцевые / Dugókulcskészlet / Trusa tubulare / Nástrčné kľúče / Nástrčné kľúče / Nasadni ključiči / Veržlerakció antgialai / Nomināmo galvu komplekts / Padrīnātmed / Сменная накруйница за ключове / Nasadni ključeviči / Ključeviči natikači / Σετ με καρδιάκια / Llaves de vaso / Set di bussole SuperLock / Chaves tubulares / Clefs à douilles / Dopsleutels



**NEO**  
TOOLS

1/4" - 4-4.5-5-5.5-6-7-8-9-10-11-12-13-14 mm  
1/2" - 10-11-12-13-14-15-17-19-20-21-22-24-27 mm

1/2" - 16, 21 mm

1/2" - 72T  
1/4" - 72T

1/4" - 150 mm

1/2" 1/4" 1/2Mx3/8F

1/2" - 125, 250 mm  
1/4" - 50, 100 mm

1/4"



10-11-12-13-14-15-17-19 mm

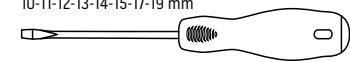

SL 5.5x38mm / SL 6.5x100mm  
PH1x38mm / PH2x100mm

1/4"

SL: 3-4-5-6-7-8

PH: 0-1-2-2-3

PZ: 0-1-2-2-3

T: 8-10-15-20-25-27-30-40-45

TT: 8-10-15-20-25-27-30-40-45

H: 3-4-5-5.5-6-8

1.5-2-2.5-3-4-5-6-8-10 mm



Ref. 10-206 1/3 EAN 5907558463224



**NEO**  
TOOLS

1/4" - 4-4.5-5-5.5-6-7-8-9-10-11-12-13-14 mm  
1/2" - 10-11-12-13-14-15-16-17-18-19-20-21-22-24-27-30-32 mm

1/4" - 6-7-8-9-10-11-12-13 mm  
1/2" - 14-15-17-19-22 mm

1/4" - E4-E5-E6-E7-E8  
1/2" - E10-E11-E12-E14-E16-E18-E20-E24

1/2" - 16, 21 mm

1/4" - 72T, 155 mm  
1/2" - 72T, 255 mm

1/4" - 150 mm

1/2" 1/4" 1/2Mx3/8F

5/16" - 1/2"

1/2" - 125, 250 mm  
1/4" - 50, 100 mm

1/4", 115 mm

T: 40-45-50-55-60

H: 7-8-10-12-14

PH: 3-4

PZ: 3-4

SL: 8-10-12

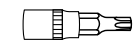

1/4" - T: 8-10-15-20-25-27-30

PH: 1-2

PZ: 1-2

SL: 4-5-5-7

H: 3-4-5-6

1.5-2-2.5 mm



Ref. 10-212 1/3 EAN 5907558468885



## Klucze nasadowe

Socket wrenches / Steckschlüssel / Набор сменных головок / Ключи торцевой / Dugókulcskészlet / Trusa tubulare / Nástrčné kľúče / Nástrčné klúče / Nasadni ključji / Veržlerákció antgajai / Nomaināmo galvu komplekts / Padrinvõtmed / Сменными наконечниками для ключовое / Nasadni ključevci / Ključevci natičaki / Σετ με καρυδάκια / Llaves de vaso / Set di bussole SuperLock / Chaves tubulares / Clefs à douilles / Dopsleutels

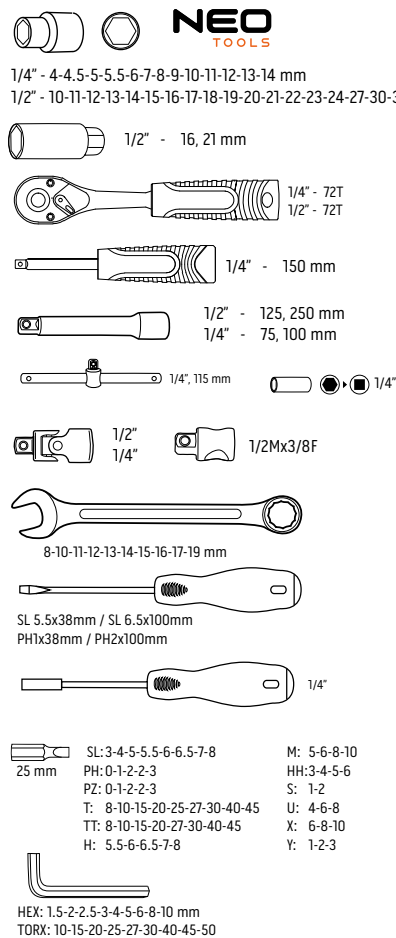

Ref. EAN  
10-208 1/2 5907558463231

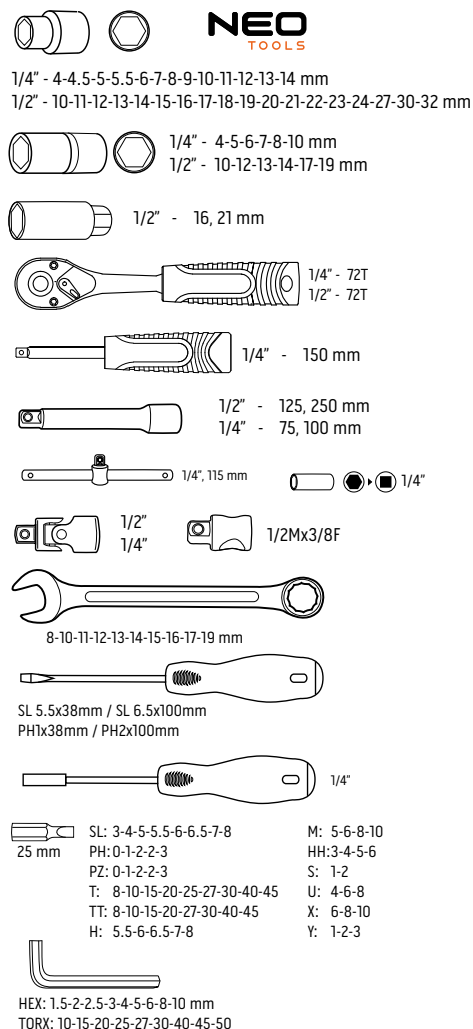

Ref. EAN  
10-210 1/2 5907558463248



## Klucze nasadowe

Socket wrenches / Steckschlüssel / Набор сменных головок / Ключи торцевые / Dugókulcskészlet / Trusa tubulare / Nástrčné kľúče / Nástrčné kľúče / Nasadni ključiči / Veržlerakció antigjai / Nomināmo galvu komplekts / Padrūnīvotmed / Сменная накруйница за ключове / Nasadni ključevci / Ključevci natičaki / Σετ με καρδιάκια / Llaves de vaso / Set di bussole SuperLock / Chaves tubulares / Clefs à douilles / Dopsleutels

**NEO**  
TOOLS

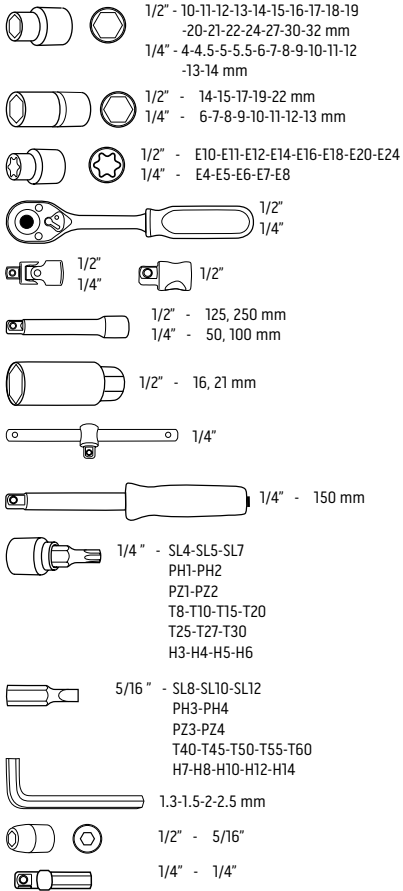

Ref. EAN  
10-066 1/4 5907558465891

**NEO**  
TOOLS

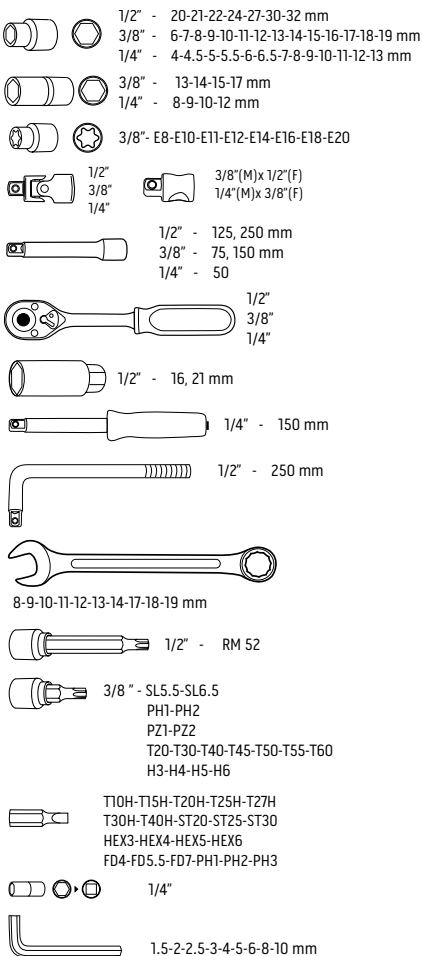

Ref. EAN  
10-070 1/2 5907558466034



## Klucze nasadowe

Socket wrenches / Steckschlüssel / Набор сменных головок / Ключи торцевой / Dugókulcskészlet / Trusa tubulare / Nástrčné kľúče / Nástrčné kľúče / Nasadni ključiči / Veržlerakció antgajai / Nomaināmo galvu komplekts / Padrunvõtmed / Сменными наконечниками за ключовое / Nasadni ključeviči / Ključeviči natičakči / Σετ με καρβύδια / Llaves de vaso / Set di bussolle SuperLock / Chaves tubulares / Clefs à douilles / Dopsleutels

**NEO**  
TOOLS



3/8" - 9-10-11-12-13-14-15-16-17-18-19 mm  
1/4" - 4-4,5-5-5,5-6-7-8-9-10-11-12-13-14 mm

1/2" - 10-11-12-13-14-15-16-17-18-19  
-20-21-22-24-27-30-32 mm

1/2" - 10-12-13-14-17-19 mm  
3/8" - 10-11-12-13-14-15 mm  
1/4" - 4-5-6-7-8-9 mm

1/2" - E20-E22-E24  
3/8" - E10-E11-E12-E14-E16-E18  
1/4" - E4-E5-E6-E7-E8

1/2" 3/8" 1/4" 3/8"(M)x1/2"(F)

1/2" 3/8" 1/4"

1/2" - 125, 250 mm  
3/8" - 75, 150 mm  
1/4" - 50, 100 mm

1/4" - 150 mm

1/4"

3/8" - 16, 21 mm

8-9-10-11-12-13-14-15-16-17-18-19 mm

8x10 mm 12x13 mm 17x19 mm

3/8" - FD4-FD5,5-FD6,5  
PH1-PH2-PH3  
T30-T40-T45-T50-T55  
H3-H4-H5-H6-H8-H10  
PZ1-PZ2-PZ3

5/16" - FD4-FD5,5-FD7  
PH1-PH2-PH3  
T10H-T15H-T20H-T25H  
T27H-T30H-T40H  
ST20-ST25-ST30  
HEX3-HEX4-HEX5-HEX6

1/4" 1.5-2-2.5-3-4-5-6-8-10 mm



Ref. EAN  
10-072 1/2 5907558466010



# Ключи nasadowe

Socket wrenches / Steckschlüssel / Набор сменных головок / Ключи торцевые / Dugókulcskészlet / Trusa tubulara / Nástrčné kľúče / Nástrčné kľúče / Nasadni ključiči / Verzlérakció antgaliak / Nomaināmo galvu komplekts / Padruinvõtmed / Сменными наконечниками за ключовые / Nasadni ključevci / Ključevci natičaki / Σετ με καρδιάκια / Llaves de vaso / Set di bussole SuperLock / Chaves tubulares / Clefs à douilles / Dopsleutels



**NEO**  
TOOLS

1/4" - 4-4.5-5-5.5-6-7-8-9-10-11-12-13-14 mm

3/8" - 10-11-12-13-14-15-16-17-18-19 mm

1/2" - 10-11-12-13-14-15-16-17-18-19-20-21-22-24-27-30-32 mm



1/4" - 4-5-6-7-8-9-10 mm

3/8" - 10-11-12-13-14-15 mm

1/2" - 16-17-18-19-22 mm



1/4" - E4-E5-E6-E7-E8

3/8" - E10-E11-E12-E14-E16-E18

1/2" - E20-E24

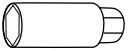

3/8" - 14, 18 mm

1/2" - 16, 21 mm

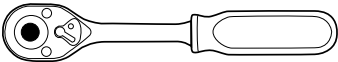

1/4" - 90T

3/8" - 90T

1/2" - 90T

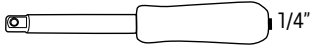

1/4"

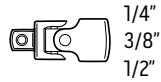

1/4"

3/8"

1/2"

1/2Mx3/8F

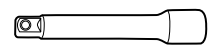

1/4" - 50, 100 mm

3/8" - 150 mm

1/2" - 125, 250 mm



1/4"



1/4"

3/8" - 8 mm

1/2" - 10 mm

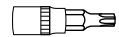

1/4" - T: 8-9-10-15-20-25-27-30

TT: 8-9-10-15-20-25-27-30

PH: 0-1-2

PZ: 0-1-2

SL: 4-5.5-6.5-7

H: 3-4-5-6

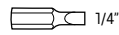

1/4"

T: 10-15-20-25-27-30

TT: 15-20-25-30-40

H: 3-4-5-6-7

PH: 0-1-2-3

PZ: 1-2-3

SL: 4-5.5-5.5-7

S: 1-2-3



8 mm



10 mm

T: 40-45-50

T: 55-60-70

TT: 40-45-50

TT: 55-60-70

H: 7-8-10-12-14

PH: 3-4

PZ: 3-4

SL: 8-10-12



1.27-1.5-2-2.5-3-4-5 mm



25 years  
GUARANTEE

CrV  
steel

1/2"

3/8"

1/4"

x182

PRECISE  
4°  
90T

NEW  
PATENTED  
DESIGN



Ref. EAN

10-074 1/2 5907558466027





# Klucze nasadowe

Socket wrenches / Steckschlüssel / Набор сменных головок / Ключи торцевые / Dugókulcskészlet / Trusa tubulare / Nástrčné kľúče / Nástrčné kľúče / Nasadni ključji / Veržlerakció antgalia / Nomināmo galvu komplekts / Padrunvõtmed / Сменными наконечники за ключевые / Nasadni ključevci / Ključevci natikači / Σετ με καριδάκια / Llaves de vaso / Set di bussole SuperLock / Chaves tubulares / Clefs à douilles / Dopsleutels

**NEO**  
TOOLS



1/4" - 4-4.5-5-5.5-6-7-8-9-10-11-12-13-14 mm  
3/8" - 10-11-12-13-14-15-16-17-18-19 mm  
1/2" - 10-11-12-13-14-15-17-19-20-21-22-24-27-30-32 mm



1/4" - 4-5-6-7-8-9-10 mm  
3/8" - 10-11-12-13-14-15 mm  
1/2" - 16-17-18-19-22 mm



1/4" - E4-E5-E6-E7-E8  
3/8" - E10-E11-E12-E14-E16-E18  
1/2" - E20-E22-E24



3/8" - 18 mm  
1/2" - 16, 21 mm

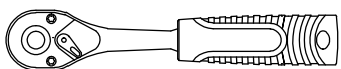

1/4" - 72T 3/8" - 72T 1/2" - 72T

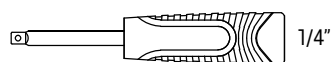

1/4"

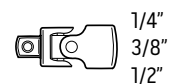

1/4"  
3/8"  
1/2"

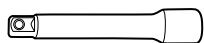

1/4" - 50, 100 mm  
3/8" - 150 mm  
1/2" - 125, 250 mm



1/4" - 115 mm  
1/2" - 250 mm

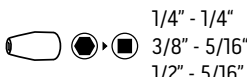

1/4" - 1/4"  
3/8" - 5/16"  
1/2" - 5/16"

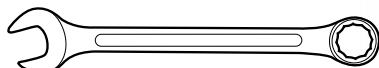

8-10-11-12-13-14-15-16-17-18-19-22 mm

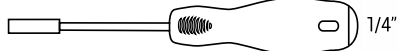

1/4"



1/2" - T: 55-60  
1/4" - T: 25-27-30-35-40-40-45-50  
TT: 27-30-35-40-45-50  
PH: 3-4  
PZ: 3-4  
SL: 6-6.5-8  
H: 5.5-6-6.5-7-8  
M: 5-6-8-10



1/4"  
T: 25-27-30-35-40-45 M: 5-6-8-10  
TT: 27-30-35-40-45 HH: 3-4-5-6  
H: 5.5-6-6.5-7-8 S: 1-2  
PH: 1-2-3 U: 4-6-8  
PZ: 1-2-3 X: 6-8-10  
SL: 6-6.5-8 Y: 1-2-3



5/16"  
T: 25-27-30-35-40-40-45-50  
TT: 27-30-35-40-45-50  
H: 5.5-6-6.5-7-8  
PH: 3-4  
PZ: 3-4  
SL: 6-6.5-8  
M: 5-6-8-10



1.2-1.5-2-2.5-3-4-5 mm



Ref. EAN  
10-216 1/2 5907558463255



# Klucze nasadowe

Socket wrenches / Steckschlüssel / Набор сменных головок / Ключи торцевые / Dugókulcskészlet / Trusa tubulara / Nástrčné kľúče / Nástrčné kľúče / Nasadni ključji / Verzlérakció antgaliak / Nomināmo galvu komplekts / Padrinvõtmed / Сменная накруйница за ключове / Nasadni ključevci / Ključevci natičaki / Σετ με καρδιάκια / Llaves de vaso / Set di bussole SuperLock / Chaves tubulares / Clefs à douilles / Dopsleutels

**NEO**  
TOOLS



1/2" - 10-11-12-13-14-15-17-19-20-21-22-24-27-30-32 mm  
3/8" - 10-11-12-13-14-15-16-17-18-19 mm  
1/4" - 4-4.5-5-5.5-6-7-8-9-10-11-12-13-14 mm



1/2" - 16-17-18-19-22 mm  
3/8" - 10-11-12-13-14-15 mm  
1/4" - 4-5-6-7-8-9-10 mm



1/2" - E18- E20- E22- E24  
3/8" - E8- E10- E12- E14- E16  
1/4" - E4- E5- E6- E7- E8

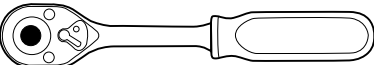

1/2" - 90T; 3/8" - 90T; 1/4" - 90T

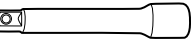

1/2" - 125, 250 mm  
3/8" - 125 mm  
1/4" - 50, 100 mm



1/2" - 16, 21 mm  
3/8" - 18 mm

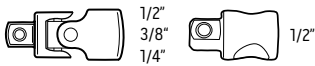

1/2"  
3/8"  
1/4"



1/2" - T55-T60  
1/4" - SL4-SL5.5-SL6.5-SL7  
PZ1-PZ2-PZ3, PH1-PH2-PH3  
T8-T9-T10-T15-T20-T25-T27-T30  
TT8-TT9-TT10-TT15-TT20-TT25-TT27-TT30  
H3-H4-H5-H6

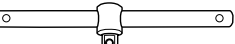

1/4" - 115 mm



1/4" - 210 mm



1/4" - 150 mm



8-9-10-11-12-13-14-15-16-17-18-19 mm



5/16" - T25-T27-T30-T35-T40-T45-T50  
H5.5-H6-H7-H8, SL6-SL6.5-SL8  
PH3-PH4, PZ3-PZ4, M5-M6-M8-M10



1/4" - H3, H4, H5, H6, H3, H4, H5, H6  
PH1, PH2, PZ1, PZ2, T8, T10, T15, T20,  
T25, TT10, TT15, TT20, TT25, TT40,  
TT8, TT10, TT20, TT25, M5, M6,  
M8, SL4, SL5, SL5.5, TRI-WING 1, 2, 3,  
TORQ 6, 8, 10, S1, S2, SL4, SL6, SL8



1/2" - 5/16"  
3/8" - 5/16"  
1/4" - 5/16"



(1,27-1,5-2mm) x 2  
2,5-3-4-5 mm

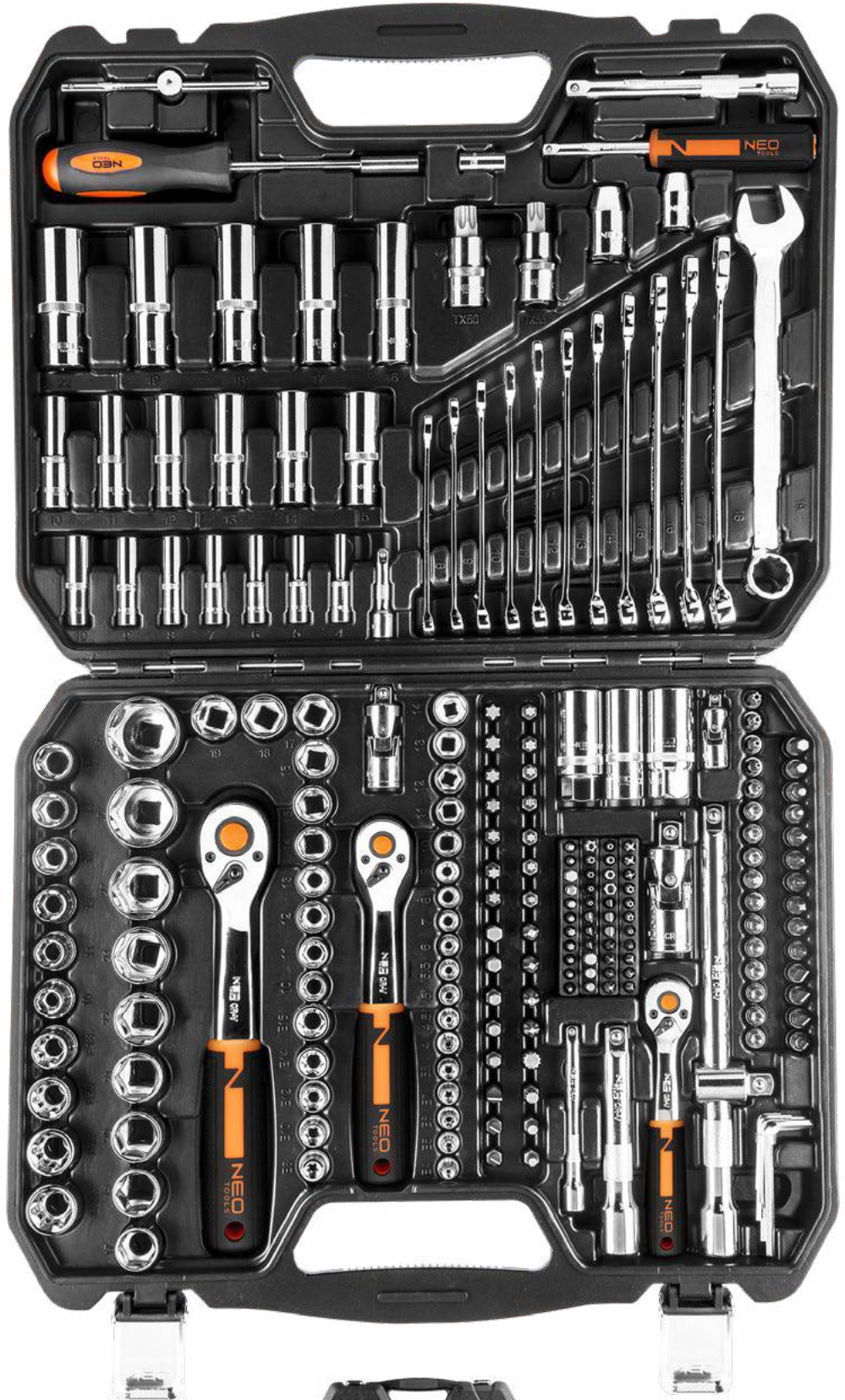

Ref. EAN

10-076 1/2 5907558465907



# Klucze nasadowe

Socket wrenches / Steckschlüssel / Набор сменных головок / Ключи торцевой / Dugókulcskészlet / Trusa tubulare / Nástrčné kľúče / Nástrčné ključice / Nasadni ključiči / Veržlerakció antgátiai / Nomaināmo galvu komplekts / Padrinvõtmed / Сменная накруйница за ключове / Nasadni ključevci / Ključevci natiakači / Σετ με καρυδάκια / Llaves de vaso / Set di bussole SuperLock / Chaves tubulares / Clefs à douilles / Dopsleutels

**NEO**  
TOOLS



1/2" - 10-13-15-16-17-18-19-20-21-22-23-24-27-30-32 mm  
7/16", 1/2", 9/16", 5/8", 11/16", 3/4", 13/16", 7/8"  
3/8" - 10-11-12-13-14-15-16-17-18-19 mm  
1/4" - 3.5-4-4.5-5-5.5-6-6.5-7-8-9-10-11-12-13-14 mm  
3/8", 11/32", 5/16", 9/32", 1/4", 5/32", 3/16"

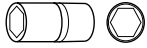

1/2" - 15-16-17-18-19-22 mm  
3/8" - 10-11-12-13-14-15 mm  
1/4" - 4-5-6-7-8-9-10 mm



1/2" - E16-E18-E20-E22-E24  
3/8" - E10-E11-E12-E14  
1/4" - E4-E5-E6-E7-E8

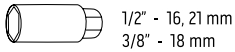

1/2" - 16, 21 mm  
3/8" - 18 mm

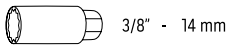

3/8" - 14 mm

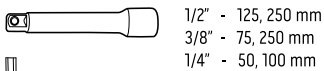

1/2" - 125, 250 mm  
3/8" - 75, 250 mm



1/4" - 50, 100 mm

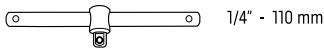

9pcs  
1/4" - 110 mm



1/4"



1/4"



1/4"

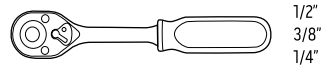

1/2"  
3/8"  
1/4"

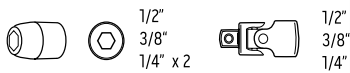

1/2"  
3/8"  
1/4" x 2  
1/2"  
3/8"  
1/4"



1/2"  
3/8"



1/4"  
1/4"x1/4"  
1/4"x3/8"

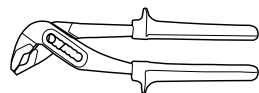
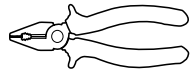

8-9-10-11-12-13-14-15-17-19-22 mm



L=75mm  
8pcs



5/16" L=30mm  
24pcs



L=25mm  
60pcs



Ref. EAN  
10-078 1/2 5907558465914



# Klucze nasadowe

Socket wrenches / Steckschlüssel / Набор сменных головок / Ключи торцевые / Dugókulcskészlet / Trusa tubulare / Nástrčné kľúče / Nástrčné kľúče / Nasadni ključiči / Verzlérakció antigaljai / Nomināmo galvu komplekts / Padrūvītmed / Сменная накруйница за ключове / Nasadni ključevci / Ključevci natičaki / Σετ με καρδιάκια / Llaves de vaso / Set di bussole SuperLock / Chaves tubulares / Clefs à douilles / Dopsleutels

**NEO**  
TOOLS



1/2" - 10-11-12-13-14-15-16-17-18-19-20-21-22-24-27-30-32 mm  
1/4" - 4-4.5-5-5.5-6-7-8-9-10-11-12-13-14 mm

1/2" - 14-15-17-19-22 mm  
1/4" - 6-7-8-9-10-11-12-13 mm

1/2" - E10-E11-E12-E14-E16-E18-E20-E24  
1/4" - E4-E5-E6-E7-E8

1/2" - 16, 21 mm

1/2", 72T  
1/4", 72T

1/2" - 125 / 250 mm  
1/4" - 50 / 100 mm

1/2" 1/4" 1/2" - 3/8"

1/4"

1/4", 115 mm

1/4", 145 mm

1/2" - 5/16"

1/4"

1.27 - 1.5 - 2 - 2.5 mm

1/4" - TX - 8-10-15-20-25-27-30  
PH - 1-2  
PZ - 1-2  
SL - 4-5-5-7 mm  
HEX - 3-4-5-6 mm

1/2", 30 mm - TX - 40-45-50-55-60  
PH - 3-4  
PZ - 3-4  
SL - 8-10-12 mm  
HEX - 7-8-10-12-14 mm



Ref. EAN  
08-910 1/4 590755842113



# Klucze nasadowe

Socket wrenches / Steckschlüssel / Набор сменных головок / Ключи торцевой / Dugókulcskészlet / Trusa tubulare / Nástrčné kľúče / Nástrčné klúče / Nasadni ključiči / Veržlerakció antgajai / Nomaināmo galvu komplekts / Padrinvõtmed / Сменная накрайница за ключове / Nasadni ključevci / Ključevci natičaki / Σετ με καρβύδια / Llaves de vaso / Set di bussole SuperLock / Chaves tubulares / Clefs à douilles / Dopsleutels

**NEO**  
TOOLS



1/2" - 10-11-12-13-14-15-17-19-22-24-27-30-32 mm  
1/4" - 4-5-6-7-8-9-10-11-12 mm

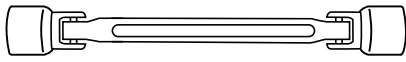

8-9 / 10-11 / 12-13 / 14-15 mm

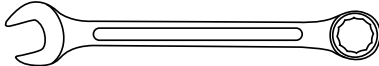

7-8-9-10-11-12-13-14-15-17-19 mm

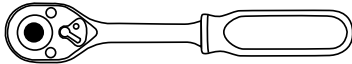

1/2", 72T  
1/4", 72T

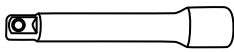

1/2" - 125, 250 mm  
1/4" - 100 mm



1/2"  
1/4"

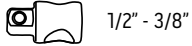

1/2" - 3/8"



1/4"

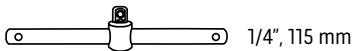

1/4", 115 mm



1/2" - 16, 21 mm



1/4"

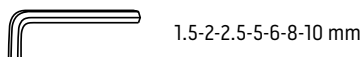

1.5-2-2.5-5-6-8-10 mm



1/2", 30 mm - TX - 10-15-20-25-30  
PH - 0-1-2-3  
PZ - 1-2-3  
SL - 3-4-5-5-7 mm  
HEX - 2-3-4-5-6 mm



Ref. EAN  
08-915 1/4 590755842120



# Klucze nasadowe

Socket wrenches / Steckschlüssel / Набор сменных головок / Ключи торцевые / Dugókulcskészlet / Trusa tubulare / Nástrčné kľúče / Nástrčné ključice / Nasadni ključiči / Veržlerakció antigaljai / Nomainámo galvu komplekts / Padrunvõtmed / Сменными наконечники за ключовые / Nasadni ključevci / Ključevci natičaki / Σετ με καριδάκια / Llaves de vaso / Set di bussole SuperLock / Chaves tubulares / Clefs à douilles / Dopsleutels

**NEO**  
TOOLS



- 1/4": 4-4-5-5-5-5-6-7-8-9-10-11-12-13-14 mm
- 3/8": 10-11-12-13-14-15-16-17-18-19 mm
- 1/2": 10-11-12-13-14-15-17-19-20-21-22-24-27-30-32 mm

- 1/4": 4-5-6-7-8-9-10 mm
- 3/8": 10-11-12-13-14-15 mm
- 1/2": 16-17-18-19-22 mm

- 1/4": E4-E5-E6-E7-E8
- 3/8": E10-E11-E12-E14-E16-E18
- 1/2": E20-E22-E24

- 3/8" - 18 mm
- 1/2" - 16, 21 mm

- 1/4", 72T
- 3/8", 72T
- 1/2", 72T

- 1/4": 50, 100 mm
- 3/8": 150 mm
- 1/2": 125, 250 mm

- 1/4"
- 3/8"
- 1/2"
- T55, T60

- 1/4", 150 mm

- 1/4", 115 mm
- 1/2", 250 mm

- 8-10-11-12-13-14-15-16-17-18-19-22 mm

- 1/4" - 1/4"
- 3/8" - 5/16"
- 1/2" - 5/16"
- 3/8" - 10 mm
- 1/2" - 10 mm

- H: 4-5-6-7-8-10-12
- T: 20-25-30-40-45-50-55
- M: 5-6-8-10-12

- H: 5-5-6-6-5-7-8
- M: 5-6-8-10
- T: 25-27-30-35-40-45-50
- TT: 27-30-35-40-45-50
- PH: 3-4
- PZ: 3-4
- SL: 6-6-5-8

- H: 5-5-6-6-5-7-8
- M: 5-6-8-10
- T: 25-27-30-35-40-45
- TT: 27-30-35-40-45
- PH: 1-2-3
- PZ: 1-2-3
- SL: 6-6-5-8
- HH: 3-4-5-6
- S: 1-2
- U: 4-6-8
- X: 6-8-10
- Y: 1-2-3

- H: 4-5-6-7-8-10-12
- T: 20-25-30-40-45-50-55
- M: 5-6-8-10-12

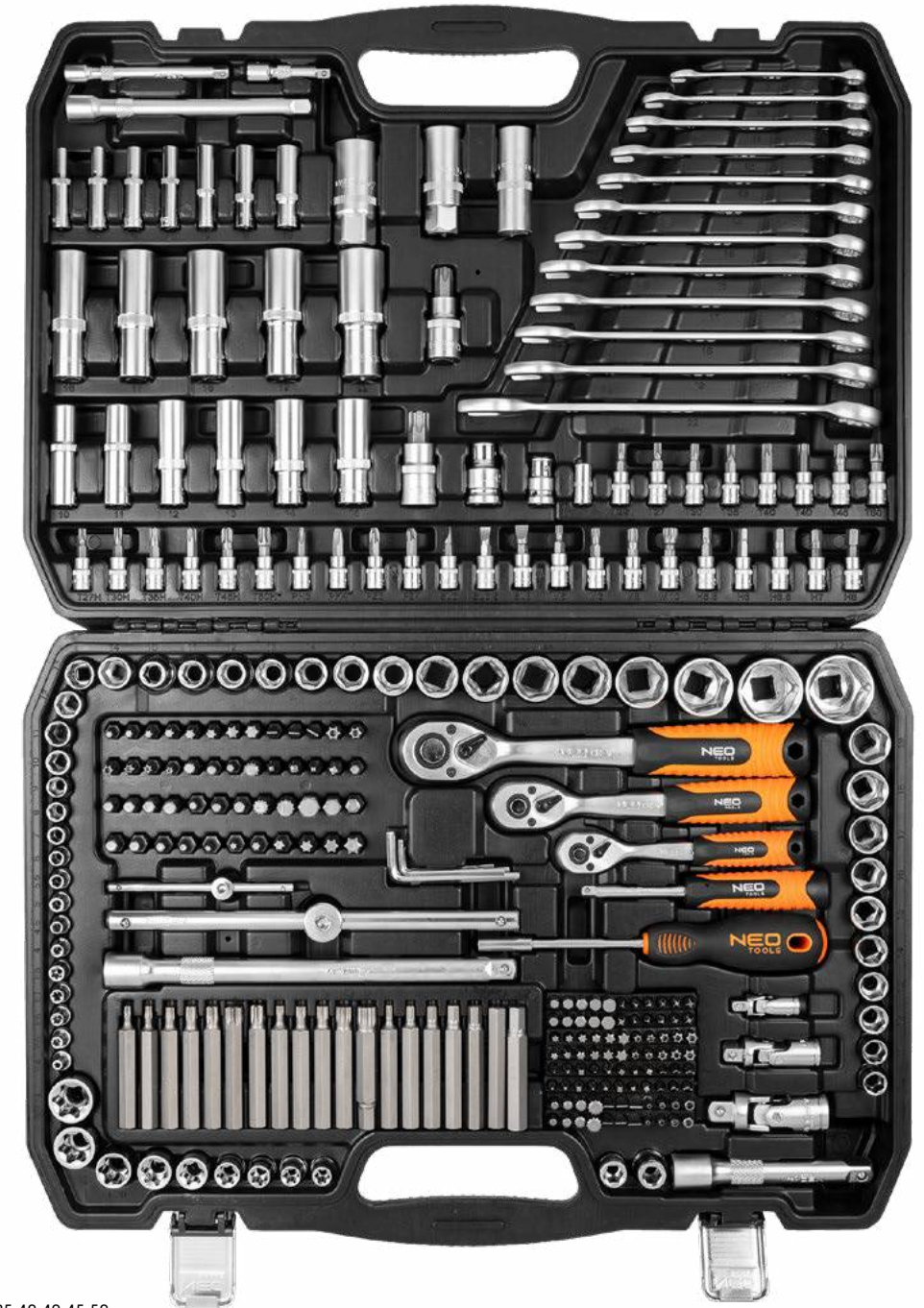

Ref. EAN  
10-218 1/4 5907558468892



## Klucze nasadowe

Socket wrenches / Steckschlüssel / Набор сменных головок / Ключи торцевые / Dugókulcskészlet / Trusa tubulare / Nástrčné kľúče / Nástrčné ključiči / Nasadni ključiči / Verzlérakció antgaliak / Nomaināmo galvu komplekts / Padrunvõtmed / Сменная накруйница за ключове / Nasadni ključevci / Ključevci natičaki / Σετ με καρδιάκι / Llaves de vaso / Set di bussola SuperLock / Chaves tubulares / Clefs à douilles / Dopsleutels

**NEO**  
TOOLS



1/4" - 5, 5.5, 6, 7, 8, 9, 10, 11, 12, 13, 14 mm



1/4" - 4, 5, 6, 7, 8 mm  
PH1, PH2, PH3,  
PZ1, PZ3, PZ2x2  
TT8, TT9, TT10, TT15, TT20, TT25,  
TT27, TT30, TT40  
H2, H2.5, H3, H4, H5, H6, H7, H8

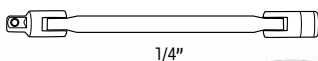

1/4"



Ref. 08-603  
EAN 5907558409307

25 years  
GUARANTEE

TÜV Rheinland  
CERTIFIED

CrV  
steel

S2  
steel

1/4"

x41



**TOPEX**



1/4"

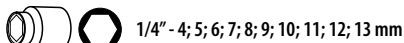

1/4" - 4; 5; 6; 7; 8; 9; 10; 11; 12; 13 mm



Ref. 38D650  
EAN 5902062386502

x11 1/4" CrV 24

**TOPEX**



1/2"

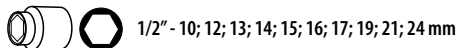

1/2" - 10; 12; 13; 14; 15; 16; 17; 19; 21; 24 mm



Ref. 38D652  
EAN 5902062386526

x11 1/2" CrV 45

**NEO**  
TOOLS



5 - 6 - 8 - 9 - 10 - 12 mm

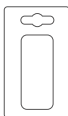

Ref. 09-570  
EAN 5907558450453

25 years  
GUARANTEE



**TOPEX**

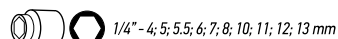

1/4" - 4; 5; 5.5; 6; 7; 8; 10; 11; 12; 13 mm

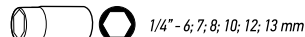

1/4" - 6; 7; 8; 10; 12; 13 mm



1/4" - 150 mm

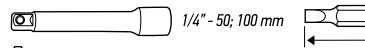

1/4" - 50; 100 mm



1.5; 2; 2.5 mm



4; 5 mm  
PH 1; PH 2  
PZ 1; PZ 2  
H5; H6  
T10; T15; T20



1/4" - 40 mm

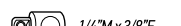

1/4" M x 3/8" F



1/4" - 110 mm



1/4" - 150 mm

HEX 1/4" 45

**TOPEX**

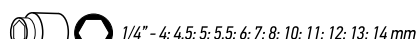

1/4" - 4; 4.5; 5; 5.5; 6; 7; 8; 10; 11; 12; 13; 14 mm



1/4" - 150 mm

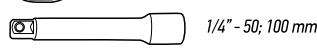

1/4" - 50; 100 mm



1/4" - 150 mm



1/4" - 110 mm



1/4" - 150 mm

HEX 1/4" 45

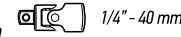

1/4" - 40 mm

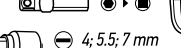

1.5; 2; 2.5 mm



4; 5.5; 7 mm



PH 1; PH 2; PH 3



PZ 1; PZ 2; PZ 3



H3; H4; H5; H6; H7; H8



T10; T15; T20; T25; T30; T40



1/4" - 150 mm



Ref. 38D640  
EAN 5902062386403

46  
elements



Ref. 38D669  
EAN 5902062042552

36  
elements



## Klucze nasadowe

Socket wrenches / Steckschlüssel / Набор сменных головок / Ключи торцевые / Dugókulcskészlet / Trusa tubulare / Nástrčné kľúče / Nástrčné kľúče / Nasadni ključiči / Veržlerakció antigyalai / Nomaināmo galvu komplekts / Padrunvõtmed / Сменная накрайница за ключове / Nasadni ključevci / Ključevci natiakači / Σετ με καρβύδια / Llaves de vaso / Set di bussolle SuperLock / Chaves tubulares / Clefs à douilles / Dopsleutels

### TOPEX

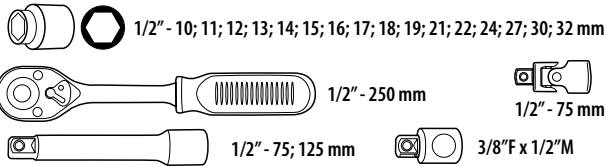

1/2"

21  
elements



Ref. 38D642  
EAN 5902062386427

### TOPEX

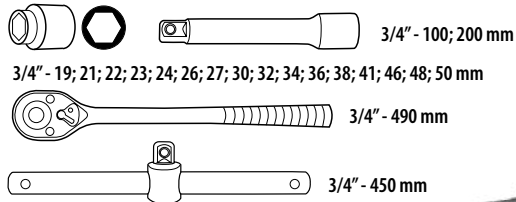

3/4"

20  
elements



Ref. 38D296  
EAN 5902062041784

### TOP TOOLS



x23

1/4"

Ref. 38D505  
EAN 5902062036988

### TOPEX

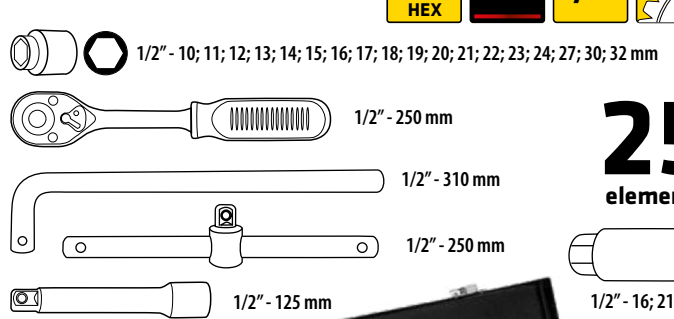

CrV

1/2"

45

25  
elements



Ref. 38D850  
EAN 5902062017307

### TOP TOOLS



x12

1/4"

Ref. 38D147  
EAN 5902062036780

### TOP TOOLS



x8

3/8"

Ref. 38D142  
EAN 5902062381422

### TOP TOOLS



x8

1/2"

Ref. 38D143  
EAN 5902062381439





## Klucze nasadowe

Socket wrenches / Steckschlüssel / Набор сменных головок / Ключи торцевые / Dugókulcskészlet / Trusa tubulare / Nástrčné kľúče / Nástrčné kľúče / Nasadni ključiči / Veržlerakció antigaljai / Nomināmo galvu komplekts / Padrunvõtmed / Сменная накладка за ключом / Nasadni ključevci / Ključevci natikači / Σετ με καριδάκια / Llaves de vaso / Set di bussole SuperLock / Chaves tubulares / Clefs à douilles / Dopsleutels

**TOP TOOLS**  1/4" - 4, 5, 6, 7, 8, 9, 10, 11, 12, 13, 14 mm

x15

 1/4" - 50, 150 mm

1/4"

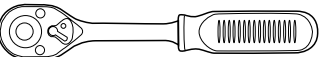
 1/4"

 1/4"



Ref.  EAN  
38D525 0/10 5902062037688

**TOP TOOLS**  1/4" - 4, 5, 6, 7, 8, 9 mm  
3/8" - 10, 11, 12, 13, 14, 15, 17, 19 mm

x20

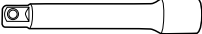
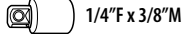
 3/8" - 70, 140 mm  1/4" F x 3/8" M

1/4"

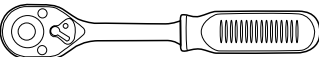
 3/8"  3/8" - 21 mm

3/8"

 1/4"



Ref.  EAN  
38D520 0/10 5902062034052

**TOP TOOLS**  1/4" - 4, 5, 6, 7, 8, 9, 10, 11, 13 mm  
1/2" - 10, 11, 12, 13, 14, 15, 16, 17, 19, 22, 24, 27, 30 mm

x53

 1/4" - 75 mm  
1/2" - 110, 250 mm

1/2"

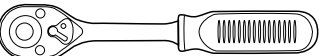
 1/4", 1/2"

   
1/4" 1/4"

 1/4"

   
1/4" 1/4"

 SL4, SL5, SL6, PH1, PH2, PZ1,  
PZ2, H3, H4, H5, H6, T10, T15, T20

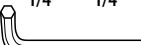
 1.5, 2, 2.5, 3, 4, 5, 6 mm



Ref.  EAN  
38D530 0/4 5902062034069

**TOP TOOLS**  1/2" - 8, 9, 10, 11, 12, 13, 14, 15, 16, 17,  
18, 19, 20, 21, 22, 24, 27, 32 mm

x47

 1/2" - 120, 250 mm

1/2"

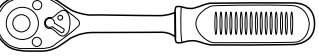
 1/2"

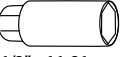
 1/4" 1/4"  
1/2" - 16, 21 mm

1/4"

 1/4"

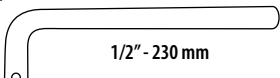
 1/2" - 230 mm

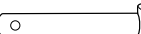
 1/2" - 240 mm

 SL3, SL4, SL5, SL6, PH0, PH1, PH2, PH3, PZ0,  
PZ1, PZ2, PZ2 H3, H4, H5, H6, T10, T15, T20, T27



Ref.  EAN  
38D550 0/4 5902062037718



## Klucze nasadowe

Socket wrenches / Steckschlüssel / Набор сменных головок / Ключи торцевые / Dugókulcskészlet / Trusa tubulare / Nástrčné kľúče / Nástrčné kľúče / Nasadni ključiči / Veržlerakció antgaliak / Nomināmo galvu komplekts / Padrinvõtmed / Сменная накруйница за ключове / Nasadni ključevci / Ključevci natikači / Σετ με καρδιάκια / Llaves de vaso / Set di bussole SuperLock / Chaves tubulares / Clefs à douilles / Dopseultels

**TOP TOOLS**

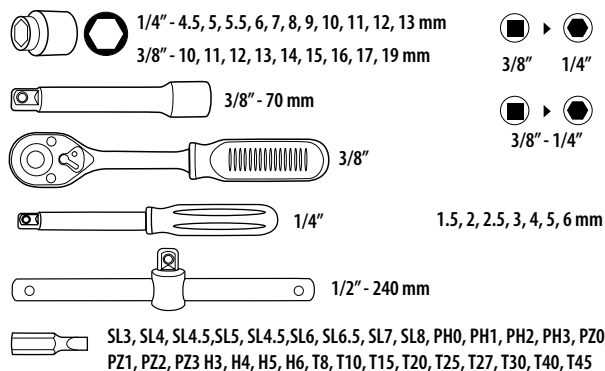

x63

1/4"

3/8"

**TOP TOOLS**

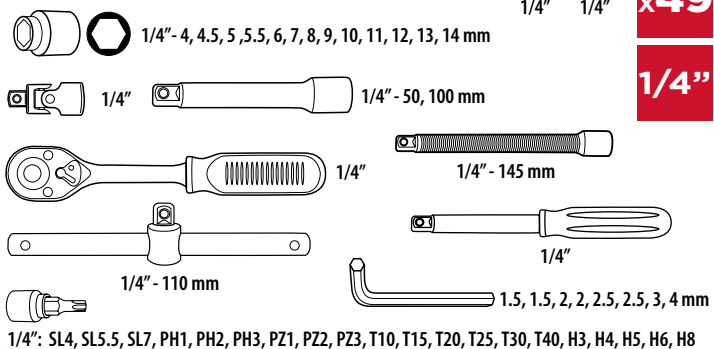

1/4" 1/4"

x49

1/4"



Ref. 38D515  
EAN 0/10 5902062037701



Ref. 38D570  
EAN 0/10 5902062043795

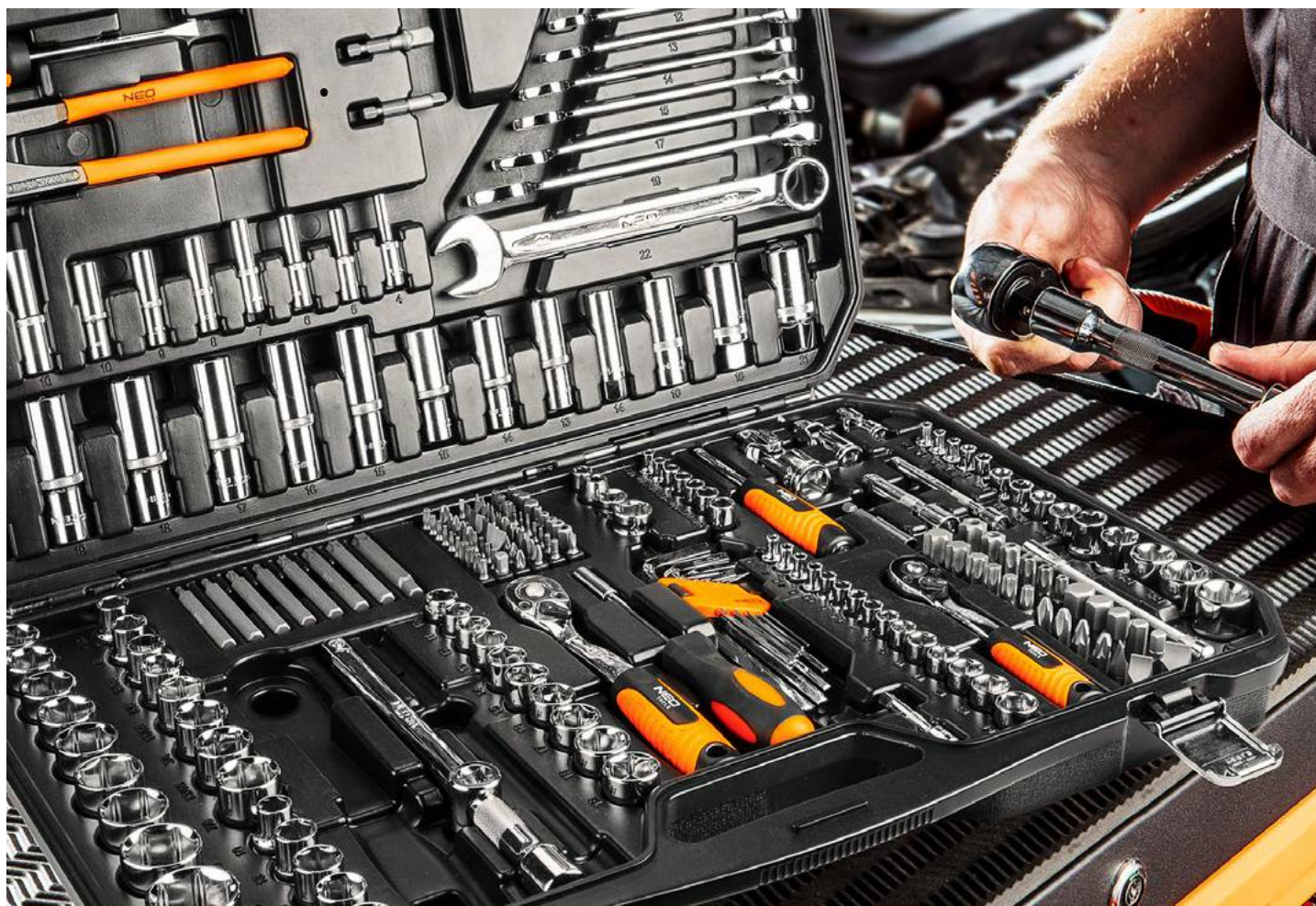

## Zestaw narzędzi

Tool and socket set / Werkzeugsatz / Набор инструментов / Инструмент з насадками, набор / Szerszámkészlet / Set scule de grădini / Sada nářadí / Súprava náradia kombi / Garnitura orodij / Įrankių komplektas / Instrumentu komplekts / Tööriistade ja padrunite komplekt / Комплект инструментов / Set alata / Gedora set / Συλλογή εργαλείων / Juego de herramientas / Set di attrezzi / Kit de ferramentas / Jeu d'outils / Gereedschapset

**NEO**  
TOOLS

1/4" - 4-5-6-7-8-9-10-11-12-13 mm

1/4", 72T

1.5-2-2.5-3-4-5-6-8-10 mm

18 mm 2 m

1/4"

150 mm

160 mm

160 mm

300 g

SL: 3-4-5-6-7  
PH: 0-1-2-2-3-3  
PZ: 0-1-2-3  
T: 10-15-20-25-27-30-40  
H: 2-3-4-5-5-5-6  
S: 0-1-2

300 g

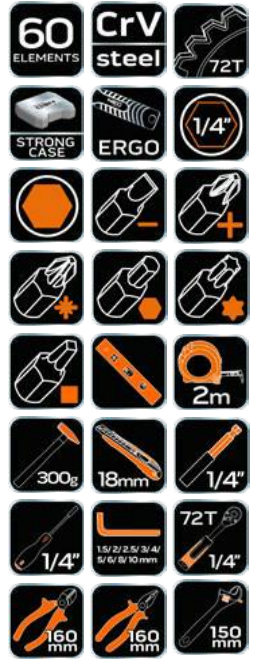

Ref. 10-200 1/4 EAN 5907558463200

1/4" - 4-4.5-5-5.6-7-8-9-10-11-12-13-14 mm

**NEO**  
TOOLS

1/4", 72T 1/4"

1/4", 50 mm 1/4"

1/4" 1/4"

1/4"

2 m

SL 5x38mm / SL 6.5x100mm  
PH1x38mm / PH2x100mm

2.0 x 50 mm / 2.5 x 50 mm  
PH0 x 50 mm / PH1 x 50 mm

150 mm

160 mm 160 mm

250 mm

300 g

150 mm x4

1/4"

SL: 4-4-5  
PH: 1-2-3  
T: 15-20  
H: 3-4

SL: 3-4-5  
PH: 1-2-3  
T: 10-15-20-25-27-30  
H: 3-4-5-6

SL: 3-4-5-6  
PH: 0-1-2  
T: 10-15-20-25-27-30  
H: 3-4-5-6



Ref. 10-202 1/3 EAN 5907558463217



# Zestaw narzędzi

Tool and socket set / Werkzeugsatz / Набор инструментов / Инструмент з насадками, набір / Szerszámkészlet / Set scule de grădină / Sada nářadí / Súprava náradia kombi / Garnitura orodij / Įrankių komplektas / Instrumentu komplekts / Тооrиistаde ја раdгуните коmpleкт / Комплект инструменти / Set alata / Gedora set / Συλλογή εργαλείων / Juego de herramientas / Set di attrezzi / Kit de ferramentas / Jeu d'outils / Gereedschapset

**NEO**  
TOOLS



1/4": 4-4.5-5-5.5-6-7-8-9-10-11-12-13-14 mm  
1/2": 12-13-14-15-16-17-18-19-20-21-22-24-27-30-32 mm



1/4": 4-5-6-7-8-9 mm  
1/2": 10-12-13-14-17-19 mm



1/2": 10-12-14-16-18-20-22-24 mm



1/2" - 16, 21 mm

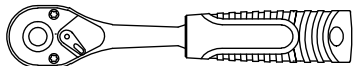

1/4", 72T, 155 mm  
1/2", 72T, 255 mm

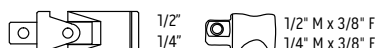

1/2" 1/2" M x 3/8" F  
1/4" 1/4" M x 3/8" F

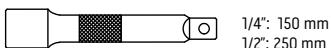

1/4": 150 mm  
1/2": 250 mm



1/4", 150 mm

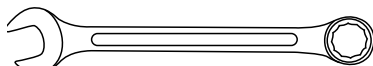

8-9-10-11-12-13-14-15-16-17-18-19 mm



180 mm



160 mm



160 mm

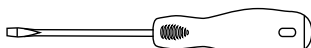

SL 4x100 mm / SL 6.5x100 mm  
PH2x150 mm / PH3x150 mm



250 mm



300 g

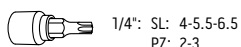

1/4": SL: 4-5.5-6.5  
PZ: 2-3  
PH: 2-3  
H: 3-4-5-6  
T: 8-10-15-20-25-27  
TT: 10-15-20-25-40



25 mm

PH: 0-1-2  
PZ: 0-1-2  
SL: 3-4-5-6



1.5-2-2.5-3-4-5-6-8-10 mm



Ref. EAN  
10-196 1/2 5907558468854



# Zestaw narzędzi

Tool and socket set / Werkzeugsatz / Набор инструментов / Инструмент з насадками, набор / Szerszámkészlet / Set scule de grădină / Sada nářadí / Súprava náradia kombi / Garnitura orodij / Įrankių komplektas / Instrumentu komplekts / Тööriistade ja padrunite komplekt / Комплект инструменти / Set alata / Gedora set / Συλλογή εργαλείων / Juego de herramientas / Set di attrezzi / Kit de ferramentas / Jeu d'outils / Gereedschapset

**NEO**  
TOOLS



25 years  
GUARANTEE

TÜV Rheinland  
CERTIFIED

CrV  
steel

1/2"

1/4"

x100

72T  
1/4"

72T  
1/2"

1/4"



STRONG CASE

ERGO

1/2" - 10-11-12-13-14-15-17-19-22-24-27-30-32 mm  
1/4" - 4-5-6-7-8-9-10-11-12-13 mm

1/4" - 9-10-11-12-13 mm

1/2" - 16, 21 mm

1/2", 72T  
1/4", 72T

1/2" - 125 mm  
1/4" - 75 mm

1/2"  
1/4"  
1.5-2-2.5 mm  
1/4"

8-10-11-12-13-14-15-17-19 mm

1/4" 1/4"

PZ 2x150 mm  
SL 6.5x100 mm / SL 5.5x38 mm /  
PH 2x100 mm / PH1x38 mm

250 mm

180 mm

225 mm

x26  
12V

1/4 - TX - 15-20-30  
PH - 1-2-3  
SL - 4-5-5-7 mm  
HEX - 3-4-5-6 mm

400 g



Ref. EAN  
08-920 1/2 5907558442137



## Zestaw narzędzi

Tool and socket set / Werkzeugsatz / Набор инструментов / Инструмент з насадками, набор / Szerszámkészlet / Set scule de grădină / Sada nářadí / Súprava nářadia kombi / Garnitura orodij / Įrankių komplektas / Instrumentu komplekts / Тööriistade ja radrunite komplekt / Комплект инструментов / Set alata / Gedora set / Συλλογή εργαλείων / Juego de herramientas / Set di attrezzi / Kit de ferramentas / Jeu d'outils / Gereedschapsset

**TOPEX**

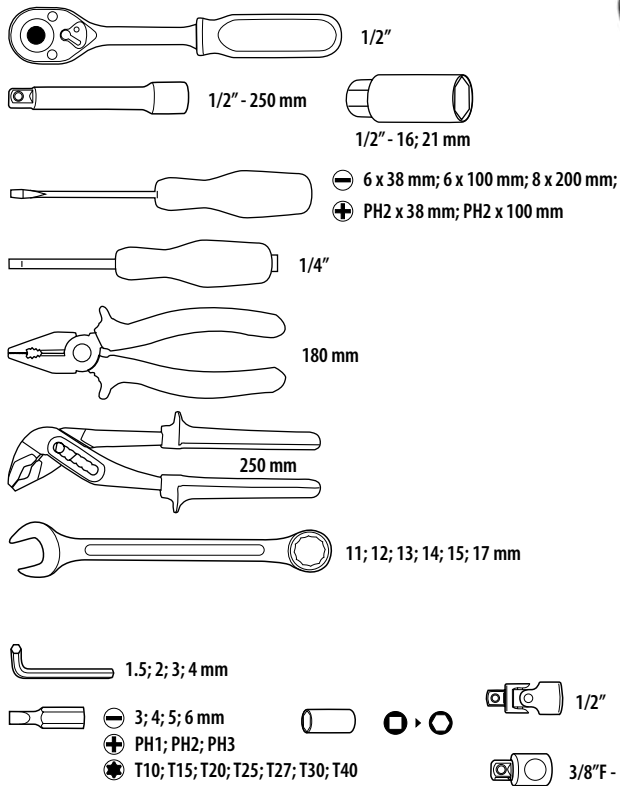

1/2"

1/4"

**56**  
elements

Ref.	☒	EAN
38D224	0/3	5902062008640

**TOPEX**

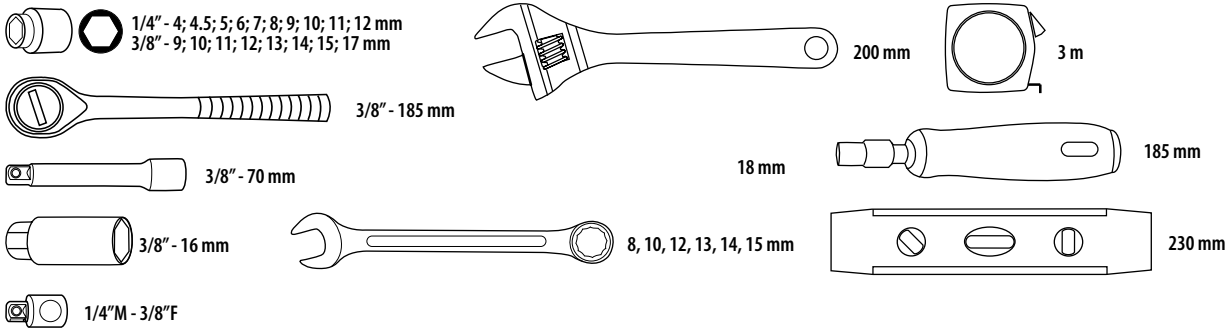

1/4"

3/8"

**135**  
elements

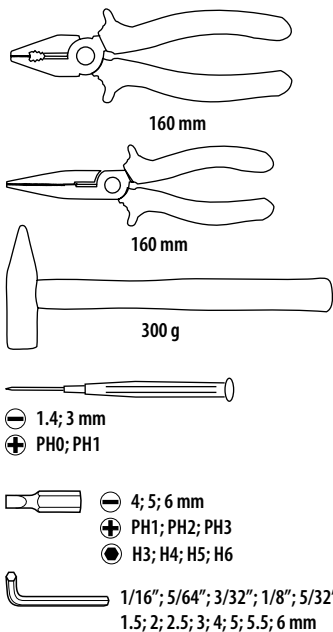

Ref.	☒	EAN
38D215	0/4	5902062044709



## Zestaw narzędzi

Tool and socket set / Werkzeugsatz / Набор инструментов / Инструмент з насадками, набір / Szerszámkészlet / Set scule de grădină / Sada nářadí / Súprava náradia kombi / Garnitura orodij / Įrankių komplektas / Instrumentu komplekts / Тööriistade ja padrunite komplekt / Комплект инструментов / Set alata / Gedora set / Συλλογή εργαλείων / Juego de herramientas / Set di attrezzi / Kit de ferramentas / Jeu d'outils / Gereedschapsset

**TOP TOOLS**

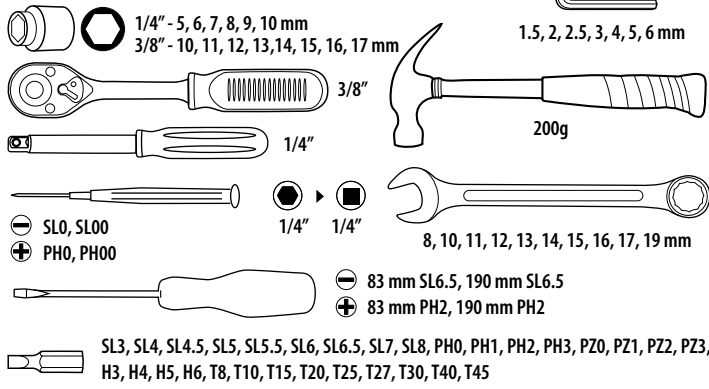

Ref. 38D500  
EAN 5902062034038

x73

1/4"

3/8"

**TOP TOOLS**

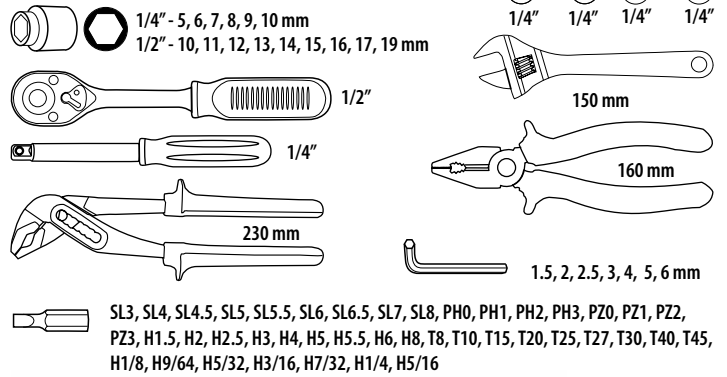

Ref. 38D510  
EAN 5902062034045

x81

1/2"

1/4"

**TOP TOOLS**

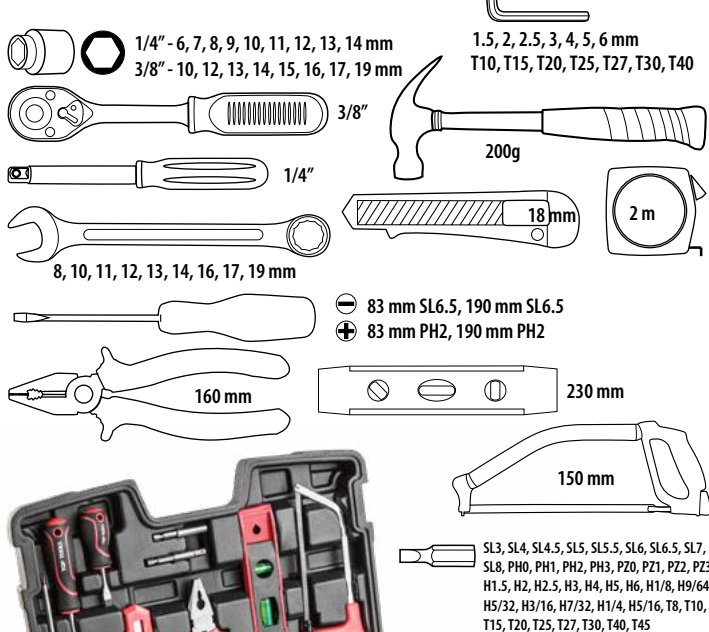

Ref. 38D535  
EAN 5902062037695

x100

1/4"

3/8"

**TOP TOOLS**

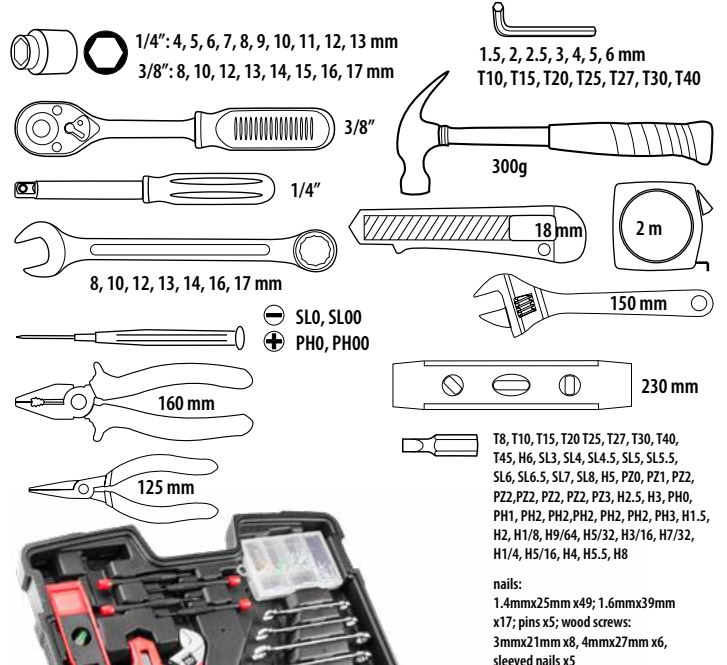

Ref. 38D545  
EAN 590206204955

1/4"

3/8"

x194

T8, T10, T15, T20, T25, T27, T30, T40, T45, H6, SL3, SL4, SL4.5, SL5, SL5.5, SL6, SL6.5, SL7, SL8, H5, PZ0, PZ1, PZ2, PZ2, PZ2, PZ2, PZ3, PZ3, H2.5, H3, PH0, PH1, PH2, PH2, PH2, PH2, PH2, PH3, H1.5, H2, H1/8, H9/64, H5/32, H3/16, H7/32, H1/4, H5/16, H4, H5.5, H8

nails:  
1.4mmx25mm x49; 1.6mmx39mm x17; pins x5; wood screws:  
3mmx21mm x8, 4mmx27mm x6, sleeved nails x5



## TECHNOLOGIA SUPERLOCK

SUPERLOCK TECHNOLOGY / ТЕХНОЛОГИЯ SUPER LOCK

- Nasadki NEO wykonane w technologii SUPERLOCK:
  - większy moment obrotowy
  - optymalny rozkład sił
  - ochrona kształtu główki śruby przed zniszczeniem
  - możliwość użycia nasadki do śrub już zniszczonych
  - użycie nasadek zwiększa trwałość elementów mocujących
- NEO sockets are manufactured in SUPERLOCK technology:
  - greater torque
  - optimal force distribution
  - protection of bolt head against damage
  - socket can be used on damaged bolts
  - use of sockets improves durability of joining elements
- Сменные головки NEO изготовлены по технологии SUPERLOCK:
  - больше крутящий момент
  - оптимальное распределение нагрузки
  - защита головки болта от повреждения
  - возможность использования сменной головки при работе с поврежденными болтами
  - использование сменных головок повышает прочность крепежа

Główny nacisk na ściankę - optymalny rozkład sił

Main pressure on a side wall - optimum force distribution

Основной нажим на стенку - оптимальное распределение нагрузки

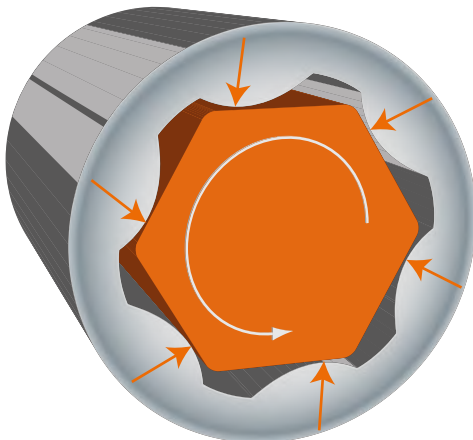

## Nasadka sześciokątna

Hexagonal socket / Sechskanteinsatz / Головка сменная шестигранная / Насадка шестигранна / Dugókulcs / Cheie tubulara hexagonală / Šestihranný nástavec / Šesthranný nástavec / Šestkotni natični nastavek / Šešiakampis antgalis / Sešstūra nomaināmā galva / Kuuskantpadrun / Шестозъелна наставка / Šesterokutna kapica / Šestougaona nasadka / Kapubāka sēfāyva / Vaso para destornillador hexagonal / Bussola esagonale / Bocal hexagonal / Douille à 6 pans / Zeskant dop

NEO  
TOOLS

25  
years  
GUARANTEE

TÜV  
Rheinland  
CERTIFIED

CrV  
steel

1/4"

SUPERLOCK

DIN  
3124

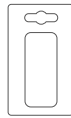
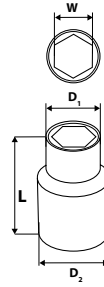

Ref.	W [mm]	L [mm]	D <sub>1</sub> [mm]	D <sub>2</sub> [mm]	⊠	EAN
08-220	4	25	7	12	100/500	5907558403787
08-221	4.5	25	7.5	12	100/500	5907558403794
08-222	5	25	8	12	25/200	5907558403800
08-223	5.5	25	8.5	12	25/200	5907558403817
08-224	6	25	9	12	100/200	5907558403824
08-225	7	25	10.5	12	25/200	5907558403831
08-226	8	25	12	12	25/200	5907558403848
08-227	9	25	13	13	50/500	5907558403855
08-228	10	25	14	14	25/200	5907558403862
08-229	11	25	16	16	50/500	5907558403879
08-230	12	25	17	17	15/150	5907558403886
08-231	13	25	18	18	15/150	5907558403893
08-232	14	25	20	20	50/500	5907558403909

NEO  
TOOLS

25  
years  
GUARANTEE

TÜV  
Rheinland  
CERTIFIED

CrV  
steel

1/4"

SUPERLOCK

DIN  
3124

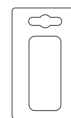
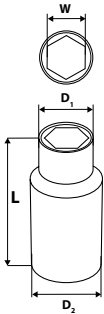

Ref.	W [mm]	L [mm]	D <sub>1</sub> [mm]	D <sub>2</sub> [mm]	⊠	EAN
08-235	4	50	7	12	50/500	5907558412055
08-236	4.5	50	7.5	12	50/500	5907558412062
08-237	5	50	8	12	50/500	5907558412079
08-238	5.5	50	8.5	12	50/500	5907558412086
08-239	6	50	9	12	50/500	5907558412093
08-240	7	50	10.5	12	25/200	5907558412109
08-241	8	50	12	12	50/200	5907558412116
08-242	9	50	13	13	50/200	5907558412123
08-243	10	50	14	14	25/200	5907558412130
08-244	11	50	16	16	50/150	5907558412147
08-245	12	50	17	17	50/300	5907558412154
08-246	13	50	18	18	50/150	5907558412161
08-247	14	50	20	20	50/150	5907558412178







## Nasadka sześciokątna

Hexagonal socket / Sechskanteinsatz / Головка сменная шестигранная / Nasadka szesciokątna / Dugókulcs / Cheie tubulara hexagonala / Šestihranný nástavec / Šesthranný nástavec / Šestkotni natični nastavek / Šešiakampis antgalis / Seššūra potaināmi galva / Kiuskantpradrin / Шестозъгълна наставка / Šesterokutna kapica / Šestougaona nasadka / Карубки ежъгълно / Vaso para destornillador hexagonal / Bussola esagonale / Vocal hexagonal / Douille à 6 pans / Zeskant dop

**NEO**  
TOOLS

25  
years  
GUARANTEE

TÜV Rheinland  
CERTIFIED

CrV  
steel

1/2"

SUPERLOCK

DIN  
3124

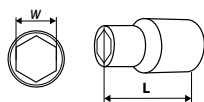

Ref.	W [mm]	L [mm]	⊠	EAN
08-008	8	38	20/200	5907558403503
08-009	9	38	20/200	5907558403510
08-010	10	38	20/100	5907558402353
08-011	11	38	20/100	5907558403527
08-012	12	38	20/100	5907558402360
08-013	13	38	20/200	5907558402377
08-014	14	38	20/100	5907558408232
08-015	15	38	20/200	5907558402384
08-016	16	38	20/200	5907558403534
08-017	17	38	20/200	5907558402391
08-018	18	38	20/200	5907558403541
08-019	19	38	20/200	5907558402407
08-020	20	38	10/100	5907558412451
08-021	21	38	20/200	5907558403558
08-022	22	38	20/200	5907558402414
08-023	23	38	10/100	5907558412468
08-024	24	38	20/100	5907558402421
08-025	25	38	10/100	5907558412475
08-026	26	42	10/100	5907558403565
08-027	27	42	10/100	5907558402438
08-028	28	42	10/100	5907558403572
08-029	29	44	10/100	5907558403589
08-030	30	44	10/100	5907558402445
08-032	32	44	10/100	5907558402452
08-036	36	44	10/0	5907558403602

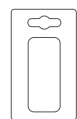

**NEO**  
TOOLS

25  
years  
GUARANTEE

TÜV Rheinland  
CERTIFIED

CrV  
steel

1/2"

SUPERLOCK

DIN  
3124

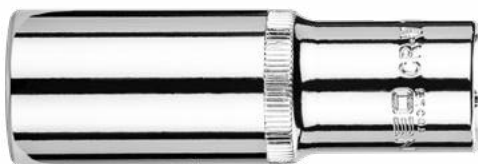
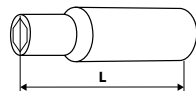

Ref.	W [mm]	L [mm]	⊠	EAN
08-039	8	77	12/144	5907558410501
08-040	9	77	20/200	5907558410518
08-041	10	77	20/200	5907558402469
08-052	11	77	20/176	5907558410525
08-042	12	77	20/200	5907558402476
08-043	13	77	20/200	5907558402483
08-053	14	77	20/176	5907558410532
08-044	15	77	20/200	5907558402490
08-054	16	77	12/144	5907558410549
08-045	17	77	20/200	5907558402506
08-055	18	77	20/96	5907558410556
08-046	19	77	20/200	5907558402513
08-056	21	77	6/96	5907558410563
08-047	22	77	6/96	5907558402520
08-058	23	77	6/72	5907558412499
08-048	24	77	6/72	5907558402537
08-049	27	77	10/100	5907558402544
08-050	30	77	10/50	5907558402551
08-051	32	77	6/48	5907558402568

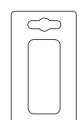

**NEO**  
TOOLS

25  
years  
GUARANTEE

TÜV Rheinland  
CERTIFIED

CrV  
steel

3/4"

DIN  
3124

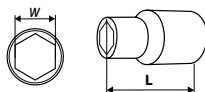

Ref.	W [mm]	L [mm]	⊠	EAN
08-300	19	51	10/80	5907558404180
08-301	21	51	10/100	5907558410600
08-302	22	51	10/80	5907558404197
08-304	24	51	10/100	5907558404203
08-306	27	52	10/80	5907558404210
08-307	28	52	10/60	5907558412543
08-308	30	54	10/60	5907558404227
08-309	32	56	10/60	5907558404234
08-316	34	56	10/60	5907558410624
08-319	35	57	10/60	5907558412567
08-311	36	59	10/40	5907558404241
08-312	38	60	10/40	5907558404258
08-313	41	64	10/40	5907558404265
08-314	46	68	10/20	5907558404272
08-315	50	72	10/20	5907558404289
08-340	55	76	10/20	5907558412574
08-341	60	78	10/20	5907558412581



**TOPEX**

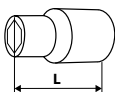

1/2"

CrV



Ref.	W [mm]	L [mm]	⊠	EAN
38D710	10	38	20/200	5902062043511
38D712	12	38	20/240	5902062043528
38D713	13	38	20/160	5902062043535
38D714	14	38	20/160	5902062043542
38D715	15	38	20/160	5902062043559
38D716	16	38	20/240	5902062043566
38D717	17	38	20/200	5902062043573
38D718	18	38	20/240	5902062043580
38D719	19	38	20/200	5902062043597
38D721	21	38	20/200	5902062043603
38D722	22	38	20/200	5902062043610
38D724	24	38	20/200	5902062043627
38D727	27	42	10/100	5902062043634
38D730	30	44	10/100	5902062043641
38D732	32	45	10/100	5902062043658



**TOPEX**

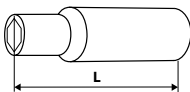

1/2"

CrV



Ref.	W [mm]	L [mm]	⊠	EAN
38D751	10	76	20/200	5902062387516
38D753	13	76	20/200	5902062387530
38D755	16	76	20/200	5902062387554
38D756	17	76	20/200	5902062387561
38D757	19	76	20/200	5902062387578
38D760	24	76	12/60	5902062357601
38D761	27	76	10/50	5902062387615
38D762	30	76	10/50	5902062387622
38D763	32	76	12/48	5902062387639



## Jedna nasadka – wiele zastosowań!

One socket – many applications! / Одна головка – много вариантов применения!

### SPLINE = UNIWERSALNE

Wszechstronność dzięki sferycznemu, 12-kątnemu kształtowi. Umożliwia pracę z większością śrub (Torx, SPLINE, 12-kątne, 6-kątne, metryczne, calowe, o kształcie kwadratu).

### SPLINE = MULTIPURPOSE

Versatile use thanks to spherical, 12 point shape. Allows to work with most bolt heads (Torx, SPLINE, 12-point, hexagonal, metric, imperial, square).

### SPLINE = УНИВЕРСАЛЬНЫЕ

Универсальность благодаря сферической, 12-гранной форме. Дает возможность работать с большинством винтов (Torx, SPLINE, 12-гранными, 6-гранными, метрическими, дюймовыми, квадратной формы).

ROZMIAR SIZE РАЗМЕР (mm)	INCH		STAR	SPLINE	KWADRAT	
	6-kątna	12-kątna			MM	INCH
4	5/32"	5/32"	E5	M10		
4.5			E6	M12	4	
5	3/16"	3/16"			4.5	
5.5	7/32"	7/32"		M14	5	
6	1/4"	1/4"	E8	M16	6	
7	9/32"	9/32"			7	9/32"
8	5/16"	5/16"	E10	M18	8	5/16"
9	11/32"	11/32"			9	11/32"
10	3/8"	3/8"	E12	M20	10	3/8"
11	7/16"	7/16"	E14		11	7/16"
12	15/32"	15/32"	E16		12	15/32"
13	1/2"	1/2"			13	1/2"
14	9/16"	9/16"	E18		14	9/16"
15	19/32"	19/32"			15	19/32"
16	5/8"	5/8"	E20		16	5/8"
17	11/16"	11/16"			17	11/16"
18	23/32"	23/32"	E22		18	23/32"
19	3/4"	3/4"	E24		19	3/4"
20	25/32"	25/32"			20	25/32"
21	13/16"	13/16"	E26		21	13/16"
22	7/8"	7/8"	E28		22	7/8"
23					23	
24	15/16"	15/16"	E30		24	15/16"
25					25	
26					26	
27	1.1/16"	1.1/16"	E34		27	1.1/16"
28					28	
29	1.1/8"	1.1/8"			29	1.1/8"
30	1.3/16"	1.3/16"	E38		30	1.3/16"
32	1.1/4"	1.1/4"	E42		32	1.1/4"

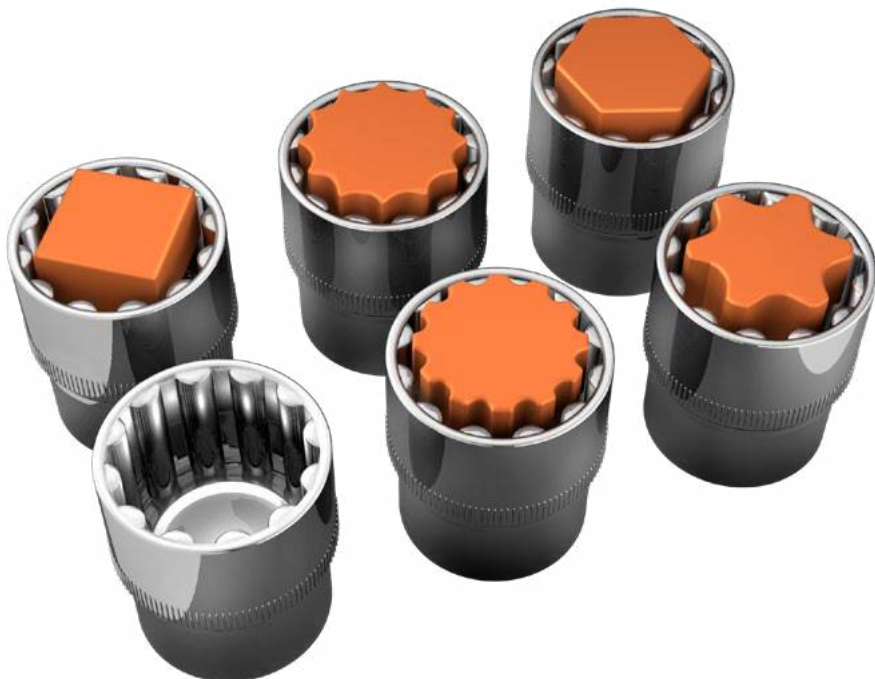

## Nasadka dwunastokątna

Bi-hexagonal socket / Zwölfkanteinsatz / Головка сменная двенадцатигранная / Насадка двенадцатигранная / Dugókulcs 12 pontos / Cheie tubulara, priză în 12 pute / Dvanáctihránný nástavec / Dvanášttrhanný nástavec / Dvanajstkotni nasadni ključ / Dvylikakampis antgalis / Divradmīstūra pomaināmā galva / Kaksteiskantpradrūn / Дванадцетогранный наставка / Dvanaesterokutna kapica / Dvanaestougona nasadka / Карубі́аки двідека́гώνно / Vaso destornillador de encaje dodecagonal / Bussola Spline / Bocal de doze ângulos / Douille à 12 pans / Twaalfkant dop

NEO TOOLS

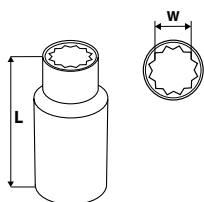

Ref.	W [mm]	L [mm]	☒	EAN
08-070	10	77	8/200	5907558405613
08-086	11	77	12/144	5907558410594
08-071	12	77	20/200	5907558405620
08-072	13	77	12/200	5907558405637
08-073	14	77	20/200	5907558408249
08-074	15	77	12/144	5907558405644
08-075	16	77	20/200	5907558406078
08-076	17	77	20/200	5907558405651
08-077	18	77	6/96	5907558406085
08-078	19	77	6/96	5907558405668
08-080	21	77	6/96	5907558408256
08-081	22	77	6/120	5907558405675
08-082	24	77	6/72	5907558405682
08-083	27	77	6/72	5907558405699
08-084	30	77	10/50	5907558405705
08-085	32	77	6/948	5907558405712

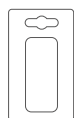

NEO TOOLS

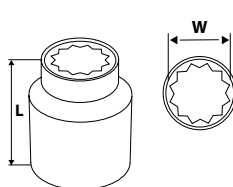

Ref.	W [mm]	L [mm]	☒	EAN
08-320	19	50	10/80	5907558406108
08-333	21	52	10/80	5907558410631
08-321	22	50	10/80	5907558406115
08-322	24	51	10/80	5907558406122
08-323	27	52	10/80	5907558406139
08-324	30	54	10/60	5907558406146
08-325	32	56	10/60	5907558406153
08-335	34	56	10/60	5907558410655
08-326	36	58	10/60	5907558406160
08-327	38	60	10/40	5907558406177
08-328	41	64	10/40	5907558406184
08-329	46	68	10/20	5907558406191
08-331	55	76	10/20	5907558406214
08-332	60	79	10/20	5907558406221

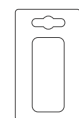

## Nasadka dwunastokątna

Bi-hexagonal socket / Zwölfkanteinsatz / Головка сменная двенадцатигранная / Nasadka dwanaścigranna / Dugókulcs 12 pontos / Cheie tubulara, priza in 12 pute / Dvanáctihranný nástavec / Dvanásthřanný nástavec / Dvanajstkotni nasadni ključ / Dvylīkamps antgalis / Divpadmīstūra nomaīnāimā galva / Kaksteiskantpadrun / Дванадесетъгълна наставка / Dvanaesterokutna karica / Dvanaestougaona nasadka / Καριδάκι δωδεκάγωνο / Vaso destornillador de encaje dodecagonal / Bussola Spline / Bocal de doze ângulos / Douille à 12 pans / Twaalfkant dop

NEO TOOLS

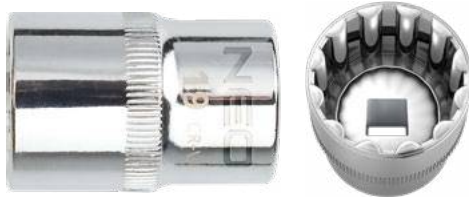
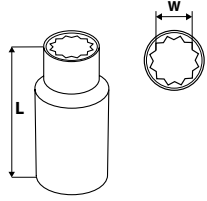

Ref.	W [mm]	L [mm]	⊠	EAN
08-580	8	38	10/200	5907558408263
08-581	9	38	10/100	5907558408270
08-582	10	38	20/100	5907558408287
08-583	11	38	10/100	5907558408294
08-584	12	38	10/100	5907558408300
08-585	13	38	10/200	5907558408317
08-586	14	38	10/200	5907558408324
08-587	15	38	10/100	5907558408331
08-588	16	38	10/200	5907558408348
08-589	17	38	10/200	5907558408355
08-590	18	38	10/200	5907558408362
08-591	19	38	10/100	5907558408379
08-592	20	38	10/100	5907558408386
08-593	21	38	10/100	5907558408393
08-594	22	38	10/100	5907558408409
08-595	23	38	10/100	5907558412505
08-596	24	38	10/200	5907558408416
08-597	27	42	10/100	5907558408423
08-598	30	44	10/100	5907558408430
08-599	32	44	10/100	5907558408447

NEO TOOLS

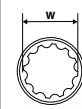

MM	10	12	13	15	17	19	22	24
INCH	3/8	15/32	1/2	19/32		3/4	7/8	15/16
STAR	E12	E16				E24		

Ref.	W [mm]	⊠	EAN
08-651	10,12,13,15,17,19,22,24	0/30	5907558406290

NEO TOOLS

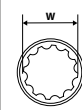

MM	10	12	13	15	17	19	22	24
INCH	3/8	15/32	1/2	19/32		3/4	7/8	15/16
STAR	E12	E16				E24		

Ref.	W [mm]	m[kg]	⊠	EAN
08-650	10,12,13,15,17,19,22,24	1,1	0/20	5907558406283

## Grzechotka

Ratchet handle / Ratsche / Трещотка / Держак з тріскоткою / Racsnikulus / Mīner de hurluitoare / Řehtačka / Račňa prepinacia / Raglja / Terkšlë / Reversa atslëga / Pörkratta pide / Трещотка / Račva za nasadni ključ / Račva za gedoru / Καρτσάκι / Llave de carraca / Cricchetto / Catraca de furar / Clé à cliquet / Rate!

NEO TOOLS

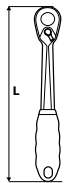

Ref.	Info	L [mm]	⊠	EAN
08-530	1/4"	155	10/50	5907558435689
08-533	3/8"	200	5/25	5907558435696
08-536	1/2"	250	5/20	5907558435702

NEO TOOLS



Ref.	Info	L [mm]	⊠	EAN
10-300	1/2"	285	1/10	5907558467338

NEO TOOLS

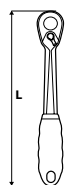

Ref.	Info	L [mm]	⊠	EAN
08-540	1/4"	155	5/50	5907558435719
08-543	3/8"	200	5/25	5907558435726
08-546	1/2"	250	5/20	5907558435733

NEO TOOLS

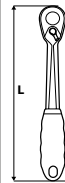

Ref.	Info	L [mm]	⊠	EAN
08-503	1/4"	145	10/50	5907558412819
08-507	3/8"	195	5/60	5907558412833
08-520	1/2"	255	5/25	5907558412840



## Grzechotka

Ratchet handle / Ratsche / Трещотка / Держак з трісотною / Racsnikulcs / Miner de hurluitoare / Řehtačka / Račňa prepínacia / Raglja / Terkšlë / Reversa atslëga / Pörkratta pide / Трещотка / Račva za nasadni ključ / Račva za gedoru / Καρτανά / Llave de carraca / Cricchetto / Catraca de furar / Clé à cliquet / Ratel

**NEO**  
TOOLS

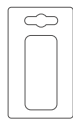
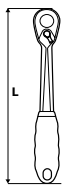

Ref.	Info	L[mm]	☒	EAN
08-504	1/4"	150	10/50	5907558420708
08-508	3/8"	210	6/48	5907558420715
08-521	1/2"	265	5/25	5907558420722

**NEO**  
TOOLS

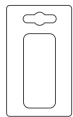
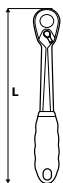

Ref.	Info	L[mm]	☒	EAN
08-523	1/4"	155	6/72	5907558432190
08-524	3/8"	200	6/48	5907558432206
08-525	1/2"	250	6/36	5907558432213

**NEO**  
TOOLS

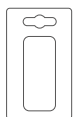
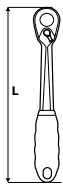

Ref.	Info	Lmin[mm]	Lmax[mm]	☒	EAN
08-502	1/4"	150	200	10/50	5907558412802
08-515	1/2"	305	445	0/25	5907558408546

**NEO**  
TOOLS

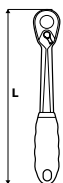

Ref.	Info	L[mm]	☒	EAN
08-519	1/2"	285	0/24	5907558410167

**NEO**  
TOOLS

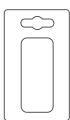
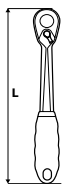

Ref.	Info	L[mm]	☒	EAN
08-501	1/4"	105	10/100	5907558412185

**NEO**  
TOOLS

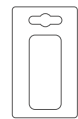
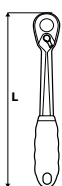

Ref.	Info	L[mm]	☒	EAN
08-514	1/4"	150	12/72	5907558406276
08-513	3/8"	200	12/48	5907558406269
08-511	1/2"	250	0/24	5907558402605

**NEO**  
TOOLS

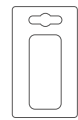
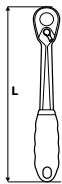

Ref.	Info	L[mm]	☒	EAN
08-516	1/2"	255	6/24	5907558409291

**NEO**  
TOOLS

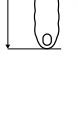
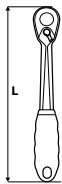

Ref.	Info	L[mm]	☒	EAN
08-355	3/4"	500	0/16	5907558404449

**NEO**  
TOOLS

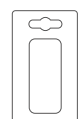
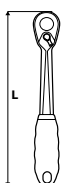

Ref.	Info	L[mm]	☒	EAN
08-512	1/4"	105	10/60	5907558403305

**TOPEX**

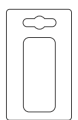
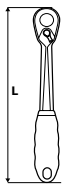

Ref.	W	L [mm]	☒	EAN
38D501	1/4"	150	10/60	5902062043139
38D521	3/8"	200	10/60	5902062043146
38D541	1/2"	250	10/40	5902062041876



## Grzechotka

Ratchet handle / Ratsche / Трещотка / Держак з тріткою / Racsnikulcs / Miner de hurluitoare / Řehtačka / Račna prepinacia / Raglja / Terkšle / Reversa atslēga / Pörkratta pide / Трещотка / Račna za nasadni ključ / Racva za gedoru / Καρταβιά / Llave de carraca / Cricchetto / Catraca de furar / Clé à cliquet / Rate!

### TOPEX

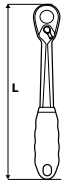

CrV

24

DIN 3122

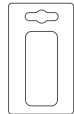

Ref.	W	L [mm]	⊠	EAN
38D502	1/4"	150	10/60	5902062385024
38D522	3/8"	210	10/60	5902062385222
38D540	1/2"	250	10/40	5902062385406

### TOPEX

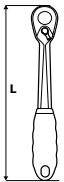

1/2"

CrV

72

DIN 3122

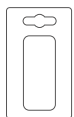

Ref.	L [mm]	⊠	EAN
38D542	255	10/40	5902062385420

### TOPEX

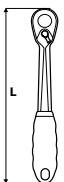

3/8"

1/2"

CrV

72

DIN 3122

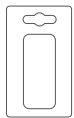

Ref.	L [mm]	⊠	EAN
38D543	135	12/48	5902062385437

### TOP TOOLS

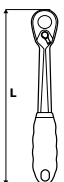

Ref.	Info	L [mm]	⊠	EAN
38D101	1/4"	150	25/100	5902062041227
38D121	3/8"	200	25/50	5902062041234
38D141	1/2"	250	12/48	5902062041241

## Pokrętło

Wheel / Drehknopf / Вороток / Маховик / Hajtókár / Clupă / Otočný knoflík / Ovládacie koliesko / Raglja / Rankena / Griezuvīte / Nurr / Върток / Kотаčići / Ručica / Пóмало / Mango / Impugnatura a L / Botão / Tourne-à-gauche / Draaiknop

### NEO TOOLS

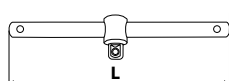

25 years GUARANTEE

TÜV Rheinland CERTIFIED

CrV steel

DIN 3122

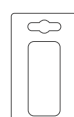

Ref.	Info	L [mm]	⊠	EAN
08-256	1/4"	110	20/200	5907558403961
08-155	3/8"	165	20/100	5907558403770
08-555	1/2"	250	5/25	5907558402650
08-353	3/4"	460	10/10	5907558404425

## Rękojeść z przegubem

Flex handle / Handgriff mit Gelenk / Вороток / Руків'я з шарніром / Hajtókár flexibilis / Maner cu articulație / Kloubové vratidlo / Klbová rukovät' / Ročaj z zglobov / Rankena su lankstu / Pagarinātājs mucipatslēgai / Liigendiga käepide / Ръкохватка с шарнир / Drška sa zglobov / Drška sa zglobov / Μανέλα ολιβαίνουσα / Mango con articulación / Impugnatura telescopica / Cabo com Articulação / Poignée articulée / Handvat met spilverbinding

### NEO TOOLS

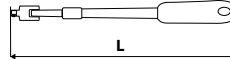

25 years GUARANTEE

TÜV Rheinland CERTIFIED

CrV steel

1/2"

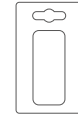

Ref.	Lmin [mm]	Lmax [mm]	⊠	EAN
08-553	470	620	5/20	5907558409598

### NEO TOOLS

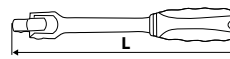

25 years GUARANTEE

TÜV Rheinland CERTIFIED

CrV steel

1/2"

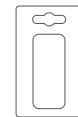

Ref.	L [mm]	⊠	EAN
08-559	250	10/40	5907558403367
08-560	450	10/20	5907558403374

### NEO TOOLS



25 years GUARANTEE

TÜV Rheinland CERTIFIED

CrV steel

3/4"

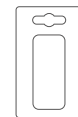

Ref.	L [mm]	⊠	EAN
08-356	510	0/10	5907558404456

### TOPEX

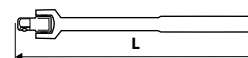

1/2"

CrV

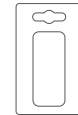

Ref.	L [mm]	⊠	EAN
38D557	250	20/40	5902062385574
38D558	450	10/20	5902062385581

### NEO TOOLS

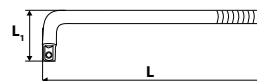

25 years GUARANTEE

TÜV Rheinland CERTIFIED

CrV steel

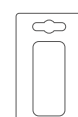

Ref.	Info	L [mm]	L <sub>1</sub> [mm]	⊠	EAN
08-556	1/2"	250	75	0/40	5907558408607
08-357	3/4"	450	110	0/10	5907558405873



## Pokrętko

Wheel / Drehknopf / Вороток / Маховик / Hajtókár / Clupă / Otočný knoflík / Ovládacie koliesko / Raglja / Rankena / Grietzvite / Nupp / Върток / Kolačici / Ručica / Пóмолo / Mango / Impugnatura a L. / Botão / Tourne-à-gauche / Draaiknop

**TOPEX**

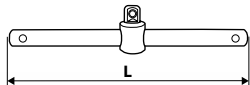

1/2" CrV

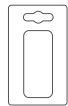

Ref.	L [mm]	☒	EAN
38D552	250	10/50	5902062044198

**TOPEX**

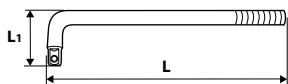

1/2" CrV

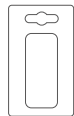

Ref.	L [mm]	L1 [mm]	☒	EAN
38D556	250	75	20/40	5902062385567

**TOP TOOLS**

1/2"

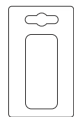

Ref.	L [mm]	☒	EAN
38D152	250	0/50	5902062041760

## Przegub

Articulated joint / Gelenk / Шарнир / Сусмає / Kardáncsukló / Articulatie / Kloub / Čap / Zglob / Lanktas / Šarniřs / Klamber / Шарнир / Zglob / Zglob / Μεμβράες / Articulación / Giunto articolato / Articulação / Articulation / Spilverbinding

**NEO TOOLS**

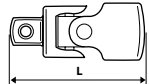

25 years GUARANTEE  
TÜV Rheinland CERTIFIED  
CrV steel  
DIN 3123

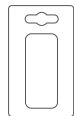

Ref.	Info	L [mm]	☒	EAN
08-255	1/4"	35	50/400	5907558403954
08-154	3/8"	50	50/400	5907558403763
08-551	1/2"	65	10/80	5907558402629

**TOPEX**

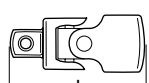

1/2" CrV

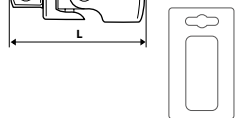

Ref.	L [mm]	☒	EAN
38D555	75	20/120	5902062044167

## Redukcja

Adaptor / Reduzierstück / Переходник / Перехідник / Adapter / Adaptor / Redukce / Redukcia / Adapter / Adapteris / Pãreja / Адаптор / Adapter / Προσαρμογέας / Adaptador / Adattatore / Redução / Réduction / Reductiestuk

**NEO TOOLS**



25 years GUARANTEE  
TÜV Rheinland CERTIFIED  
CrV steel  
DIN 3123

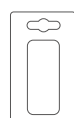

Ref.	Info	L [mm]	☒	EAN
08-562	1/4" M x 3/8" F	26	10/100	5907558403329
08-563	3/8" M x 1/2" F	37	10/100	5907558403336
08-565	1/2" M x 3/4" F	50	40/40	5907558403350
08-564	3/4" M x 1/2" F	46	10/100	5907558403343
08-550	1/2" M x 3/8" F	27	25/200	5907558402612

## Przedłużka

Extension bar / Verlängerung / Удлинитель / Подовжувач / Toldószár / Prelungitor / Prodłużovák / Predĺženie / Podajšek / Ilgiklis / Pagarinātājs / Píkendusvarras / Удължител / Produziena poluga / Προέκταση / Alargadera / Prolunga / Extensão / Prolongation / Verlengstuk

**NEO TOOLS**

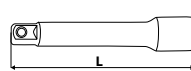

25 years GUARANTEED  
TÜV Rheinland CERTIFIED  
CrV steel  
DIN 3123

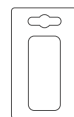

Ref.	L [mm]	Info	☒	EAN
08-251	50	1/4"	20/200	5907558403916
08-252	75	1/4"	20/200	5907558403923
08-253	100	1/4"	25/50	5907558403930
08-254	150	1/4"	25/50	5907558403947
08-151	75	3/8"	20/200	5907558403732
08-152	125	3/8"	20/200	5907558403749
08-153	150	3/8"	20/100	5907558403756
08-552	125	1/2"	10/50	5907558402636
08-554	250	1/2"	10/50	5907558402643
08-350	100	3/4"	10/40	5907558404296
08-351	200	3/4"	10/20	5907558404302
08-352	400	3/4"	0/10	5907558404418

**TOPEX**

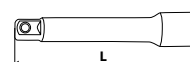

1/2" CrV

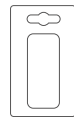

Ref.	L [mm]	☒	EAN
38D553	125	20/120	5902062044174
38D554	250	20/60	5902062044181

**TOP TOOLS**

1/2"

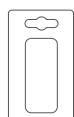

Ref.	L [mm]	☒	EAN
38D159	125, 250	0/25	5902062041296

**NEO TOOLS**

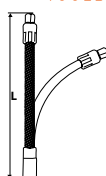

Przedłużka elastyczna  
Flexible extension  
Удлинитель гибкий

TÜV Rheinland CERTIFIED  
CrV steel

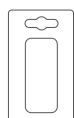

Ref.	□	L [mm]	M <sub>0max</sub> [Nm]	☒	EAN
08-557	1/4"	140	5	25/100	5907558402667
08-558	1/2"	190	40	10/80	5907558402674

## Pokrętko

Wheel / Drehknopf / Вороток / Маховик / Hajtókár / Clupă / Otočný knoflík / Ovládacie koliesko / Raglja / Rankena / Grietzvite / Nupp / Върток / Kolačici / Ručica / Пóмолo / Mango / Impugnatura a L. / Botão / Tourne-à-gauche / Draaiknop

**NEO TOOLS**

CrV steel  
1/4"  
NEW PATENTED DESIGN  
1/4"

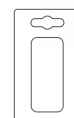

Ref.	☒	EAN
08-257	10/100	5907558466362



## Końcówka Spline na nasadce

Spline bit / Spline-Endstück / Наконечник Spline / Наконечник „Spline” / Spline bit / Punct Spline / Nástavec Spline / Nástavec Spline / Nastavek Spline / Antgalis Spline / Uzgalis Spline / Spline-otsak / Накрайник Spline / Nastavak Spline / Nastavak Spline / Μύτη Spline / Punta Spline / Inserto Spline su bussola / Ponteiro Spline / Embout Spline / Spline eindstuk

NEO  
TOOLS

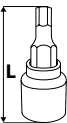

Ref.	Info	L[mm]	☒	EAN
08-730	M5	55	12/144	5907558411911
08-731	M6	55	12/144	5907558411928
08-732	M8	55	12/144	5907558411935
08-733	M10	55	12/144	5907558411942
08-734	M12	55	12/160	5907558411959
08-735	M14	55	12/160	5907558411966
08-736	M16	55	12/144	5907558411973

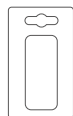

NEO  
TOOLS

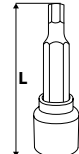

Ref.	Info	L[mm]	☒	EAN
08-740	M5	100	12/96	5907558411980
08-741	M6	100	12/96	5907558411997
08-742	M8	100	12/96	5907558412000
08-743	M10	100	12/96	5907558412017
08-744	M12	100	12/96	5907558412024
08-745	M14	100	12/96	5907558412031
08-746	M16	100	12/96	5907558412048

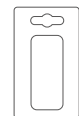

## Końcówka na nasadce

Bit on socket / Einsatz auf Aufsatz / Головка сменная с насадкой / Наконечник на насадку / Bit / Cap tubulara cu antrenor / Koncovka na nástavce / Koncovka na nástavce / Nastavek za nasadni ključ / Torcinis antgalis su laikikliu / Nomaināmā galva ar uzgali / Otsak padrunil / Накрайник на наставката / Nastavak na kapici / Nastavak za nasadke / Καρυδάκι με μύτη / Vaso / Inserto con bussola / Ponteiros no bico / Embouts sur ajutage / Eindstuk op dop

NEO  
TOOLS

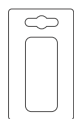
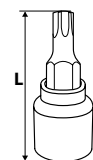

Ref.	Info	L[mm]	☒	EAN
10-316	PH1	37	20/200	5907558471243
10-317	PH2	37	20/200	5907558471250
10-318	PH3	37	20/200	5907558471267
10-319	PZ1	37	20/200	5907558471274
10-320	PZ2	37	20/200	5907558471281
10-321	PZ3	37	20/200	5907558471298

NEO  
TOOLS

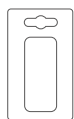
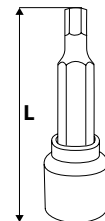

Ref.	Info	L[mm]	☒	EAN
10-334	PH1	87	30/300	5907558471427
10-335	PH2	87	30/300	5907558471434
10-336	PH3	87	30/300	5907558471441
10-337	PZ1	87	30/300	5907558471458
10-338	PZ2	87	30/300	5907558471465
10-339	PZ3	87	30/300	5907558471472

## Końcówki sześciokątne na nasadce

Hexagonal bits on socket / Sechskanteinsätze auf Aufsatz / Головки шестигранные с насадкой / Наконечники шестигранные на насадку / Imbusz bit / Trusa capete tubulare cu antrenor / Koncovky šestihhranné na nástavce / Šestihhranné koncovky na nástavce / Šestkotní nastavky za nasadni ključ / Šešiakampiai antgaliai su laikikliu / Nomaināmā galva ar sešstūra uzgājiem / Kuuskantsakud padrunil / Шестъъгълни накрайници на наставката / Šesterokutni nastavci na kapici / Šestougolni nastavci za nasadke / Καρυδάκι με μύτες εξάγωνες / Vasos destornilladores hexagonales / Inserto esagonale con bussola / Ponteiros hexagonais no bico / Embouts à 6 pans sur ajutage / Zeskant eindstukken op dop

NEO  
TOOLS

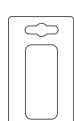
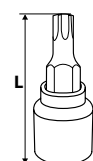

Ref.	Info	L[mm]	☒	EAN
10-310	H3	37	20/200	5907558471182
10-311	H4	37	20/200	5907558471199
10-312	H5	37	20/200	5907558471205
10-313	H6	37	20/200	5907558471212
10-314	H7	37	20/200	5907558471229
10-315	H8	37	20/200	5907558471236

NEO  
TOOLS

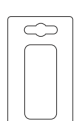
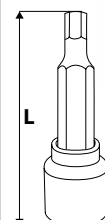

Ref.	Info	L[mm]	☒	EAN
10-329	H4	87	30/300	5907558471373
10-330	H5	87	30/300	5907558471380
10-331	H6	87	30/300	5907558471397
10-332	H7	87	30/300	5907558471403
10-333	H8	87	30/300	5907558471410

NEO  
TOOLS

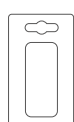
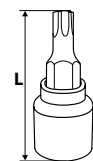

Ref.	Info	L[mm]	☒	EAN
08-770	H5	55	20/140	5907558409765
08-771	H6	55	12/144	5907558409772
08-772	H7	55	20/160	5907558409789
08-773	H8	55	12/144	5907558409796
08-774	H10	55	20/160	5907558409802
08-775	H12	55	20/160	5907558409819
08-776	H14	55	20/160	5907558409826
08-777	H17	55	20/160	5907558409833
08-778	H19	55	12/96	5907558409840

NEO  
TOOLS

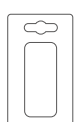
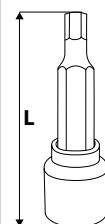

Ref.	Info	L[mm]	☒	EAN
08-780	H5	100	12/96	5907558409857
08-781	H6	100	20/100	5907558409864
08-782	H7	100	12/96	5907558409871
08-783	H8	100	20/100	5907558409888
08-784	H10	100	20/100	5907558409895





## Końcówki sześciokątne na nasadce

Hexagonal bits on socket / Sechskanteinsätze auf Aufsatz / Головки шестигранные с насадкой / Наконечники шестигранные на насадці / Imbusz bit / Trusa capete tubulare cu antrenor / Koncovky šestihranné na nástavce / Šesthranné koncovky na nástavce / Šestkotni nastavki za nasadni ključ / Šešakantipiai antgaliai su laikikliu / Nomaināmā galva ar sešstūra uzgaļiem / Kuuskantotsakud padrūnīt / Шестъъглии накрайници на наставката / Šesterokutni nastavci na kapici / Šestougaoni nastavci za nasadke / Καρυδάκι με μίτςες εξήγωνες / Vasos destornilladores hexagonales / Inserto esagonale con bussola / Ponteiros hexagonais no bico / Embouts à 6 pans sur ajutage / Zeskant eindstukken op dop

NEO TOOLS

● H4, H5, H6, H7, H8, H10, H12, H14, H17

25 years  
GUARANTEE

TÜVRheinland  
CERTIFIED

S2  
steel

CrV  
steel

1/2"

x9

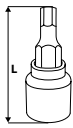

Ref.	L[mm]	☒	EAN
08-705	55	0/12	5907558409253

NEO TOOLS

● H4, H5, H6, H7, H8, H10, H12, H14, H17

25 years  
GUARANTEE

TÜVRheinland  
CERTIFIED

S2  
steel

CrV  
steel

1/2"

x9

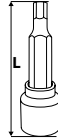

Ref.	L[mm]	☒	EAN
08-706	100	0/12	5907558409260

## Końcówki Torx na nasadce

Torx bit on socket / Torx-Einsatz auf Aufsatz / Головка сменная с насадкой Torx / Наконечник «Torx» на насадці / Torx bit / Cap tubulara cu antrenor torx / Koncovka Torx na nástavce / Koncovka Torx na nástavce / Nastavek Torx za nasadni ključ / Torcinis antgalis su laikikliu / Nomaināmā galva ar Torx uzgali / Torx-otsak padrūnīt / Накрайник Torx на наставката / Nastavak Torx na kapici / Nastavak Torx za nasadke / Καρυδάκι με μίτς Torx / Vaso torx / Inserto Torx con bussola / Ponteiros Torx no bico / Embouts Torx sur ajutage / Trox eindstuk op dop

NEO TOOLS

25 years  
GUARANTEE

S2  
steel

CrV  
steel

1/4"



Ref.	Info	L[mm]	☒	EAN
10-322	T10	37	20/200	5907558471304
10-323	T15	37	20/200	5907558471311
10-324	T20	37	20/200	5907558471328
10-325	T25	37	20/200	5907558471335
10-326	T27	37	20/200	5907558471342
10-327	T30	37	20/200	5907558471359
10-328	T40	37	20/200	5907558471366

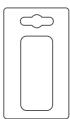
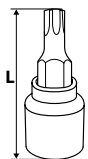

NEO TOOLS

25 years  
GUARANTEE

S2  
steel

CrV  
steel

1/4"



Ref.	Info	L[mm]	☒	EAN
10-340	T10	87	30/300	5907558471489
10-341	T15	87	30/300	5907558471496
10-342	T20	87	30/300	5907558471502
10-343	T25	87	30/300	5907558471519
10-344	T27	87	30/300	5907558471526
10-345	T30	87	30/300	5907558471533
10-346	T40	87	30/300	5907558471540

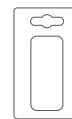
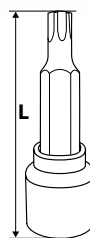

NEO TOOLS

25 years  
GUARANTEE

TÜVRheinland  
CERTIFIED

S2  
steel

CrV  
steel

1/2"



Ref.	Info	L[mm]	☒	EAN
08-750	T20	55	12/144	5907558409604
08-751	T25	55	12/144	5907558409611
08-752	T27	55	12/144	5907558409628
08-753	T30	55	12/144	5907558409635
08-754	T40	55	20/160	5907558409642
08-755	T45	55	20/160	5907558409659
08-756	T50	55	12/144	5907558409666
08-757	T55	55	20/160	5907558409673
08-758	T60	55	12/144	5907558417388
08-759	T70	55	12/144	5907558417395

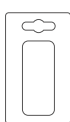
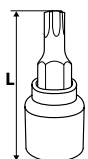

NEO TOOLS

25 years  
GUARANTEE

TÜVRheinland  
CERTIFIED

S2  
steel

CrV  
steel

1/2"



Ref.	Info	L[mm]	☒	EAN
08-760	T20	100	12/96	5907558409680
08-761	T25	100	20/100	5907558409697
08-762	T27	100	20/100	5907558409703
08-763	T30	100	20/100	5907558409710
08-764	T40	100	12/96	5907558409727
08-765	T45	100	20/100	5907558409734
08-766	T50	100	20/100	5907558409741
08-767	T55	100	20/100	5907558409758

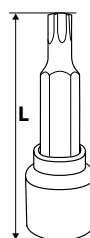

## Końcówki Torx na nasadce

Torx bit on socket / Torx-Einsatz auf Aufsatz / Головка сменная с насадкой Torx / Наконечник «Torx» на насадке / Torx bit / Cap tubulara cu antrenor torx / Koncovka Torx na nástavce / Koncovka Torx na nástavce / Nastavek Torx za nasadni ključ / Torcinis antgalis su laikikliu / Nomaināma galva ar Torx uzgali / Torx-otsak padrunit / Накрайник Torx на наставката / Nastavak Torx na kapici / Nastavak Torx za nasadke / Καρυδάκι με μύτη Torx / Vaso torx / Inserto Torx con bussola / Ponteiros Torx no bico / Embouts Torx sur ajutage / Trox eindstuk op dop

**NEO**  
TOOLS



T20, T25, T27, T30, T40, T45, T50, T55, T60

25  
years  
GUARANTEE



S2  
steel

1/2"

CrV  
steel

x9



**NEO**  
TOOLS

S2  
steel

x49

CrV  
steel



1/2"

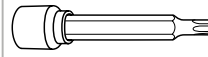
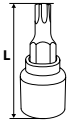

H6, H7, H8, H10, H12  
T25, T30, T40, T45, T50, T60  
M6, M8, M10, M12, M14



T20, T25, T27, T30, T40, T45, T50, T60

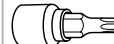

H5, H6, H7, H8, H10, H12, H14, H17, H19  
T20, T25, T27, T30, T40, T45, T50, T55, T60, T70  
M5, M6, M8, M10

Ref.	L[mm]	☒	EAN
08-707	55	0/12	5907558409277

**NEO**  
TOOLS



T20, T25, T27, T30, T40, T45, T50, T55, T60

25  
years  
GUARANTEE



S2  
steel

1/2"

CrV  
steel

x9

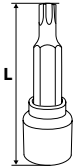

Ref.	L[mm]	☒	EAN
08-708	100	0/12	5907558409284



Ref.	☒	EAN
08-713	0/3	5907558420180

## Końcówki i nasadki torx

Torx bits and socket set / Torx-Aufsätze / Наконечники и головки торцевые Torx / Набор жпал та насадох «torx» / Torx kulcskészlet / Set canule "torx" și fixări / Bity a nástavce Torx / Súprava klúčov torx / Garnitura nastavkov z vpenjalom / Antgalii Torx ir galvuicių rinkinys / Torx atslėgu un mucipni komplekts / "Torx" otsikute ja padrunit komplekt / Βλοζκνι και ηακραιοίνυυι / Set Nasadnih klučeva I biceva / Set biceva I gedora / Συλλογή από μύτες και καρυδάκια / Puntas destornilladoras y vasos TORX / Inserti Torx / Ponteiros e Boccas Torx / Embouts et douilles Torx / Torx eindstukken en doppen

**NEO**  
TOOLS

E4, E5, E6, E7, E8, E10, E11, E12, E14, E16, E18, E20  
T10, T15, T20, T25, T27, T30, T40, T45, T50, T55, T60  
TT10, TT15, TT20, TT25, TT27, TT30, TT40, TT45, TT50, TT55



CrV  
steel

3/8"



S2  
steel

x34



Ref.	☒	EAN
08-711	0/12	5907558417111



## Końcówki Torx na nasadce

Torx bit on socket / Torx-Einsatz auf Aufsatz / Головка сменная с насадкой Torx / Наконечник «Torx» на насадку / Torx bit / Cap tubulara cu antrenor torx / Koncovka Torx na nástavce / Koncovka Torx na nástavce / Nastavek Torx za nasadni ključ / Torcinis antgalis su laikikliu / Nomaināmā galva ar Torx uzgali / Torx-otsak padrunil / Нақрайник Torx на наставката / Nastavak Torx na kapici / Nastavak Torx za nasadke / Καρυδάκι με μύτη Torx / Vaso torx / Inserto Torx con bussola / Ponteiros Torx no bico / Embouts Torx sur ajutage / Torx eindstuk op dop

**TOPEX**

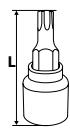

**CrV**

**1/2"**



Ref.	W [mm]	L [mm]	☒	EAN
38D805	T40	60	12/96	5902062388056
38D808	T55	60	12/96	5902062388087

**TOPEX**

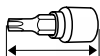

TT10; TT15; TT20; TT25; TT27; TT30; TT40

L - 35 mm

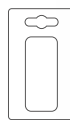

Ref.	☒	EAN
39D378	25/75	5902062393784

**TOPEX**



1/4" - T10, T15, T20, T27, T30  
3/8" - T40, T45, T47, T50, T55  
1/2" - T60

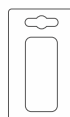

Ref.	☒	EAN
39D342	6/24	5902062008671

## Nasadki Torx

Torx sockets / Torx-Aufsätze / Головки сменные Torx / Насадки «Torx» / Torx kulcs / Tubulara cu capat torx / Nástavce Torx / Nástavce Torx / Nasadni ključi Torx / Torciniai antgaliai / Torx nomaināmas galviņas / Torx-padrūnīd / Наставки Torx / Kapice Torx / Nasadke Torx / Ανταλλακτικές μύτες Torx / Vasos torx / Bussole Torx / Bocais Torx / Douilles Torx / Torx doppen

**NEO TOOLS**

**25 years**  
GUARANTEE

**TÜVRheinland**  
CERTIFIED

**CrV**  
steel

**x9**



**1/2"**



E10, E11, E12, E14, E16, E18, E20, E22, E24

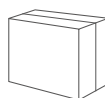

Ref.	☒	EAN
08-649	0/15	5907558417074

**TOPEX**



1/4" - E5; E6; E7; E8  
3/8" - E10; E12; E14; E16



3/8" 1/2"

**x9**

**CrV**

**1/4"**

**3/8"**



Ref.	☒	EAN
39D375	E5-E16	25/50

## Końcówki wkrętakowe

Driver bits / Einsätze für Schraubendreher / Насадки / Наконечники викрүтові / Dugókulcs bitkészlet / Set biti / Šroubovákové nástavce / Skrutkovacie nástavce / Nastavki za izvijače / Atsuktuvo antgaliai / Skrūvgrieža uzgali / Krivikeeraajatsakud / Накрайници за отвертка / Nastavci za odvijač / Nastavci za odvijač / Καταβιδόμετες / Puntas destornilladoras / Inserti lunghi e corti / Ponteiros Chave de fenda / Embouts de tournevis / Schroevendraaiereindstukken

**NEO TOOLS**



L 30 mm

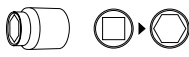

3/8" ▶ 10 mm  
1/2" ▶ 10 mm

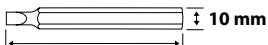

L 75 mm

- 30 mm: T20, T25, T30, T40, T45, T50, T55
- 75 mm: T20, T25, T30, T40, T45, T50, T55
- 30 mm: H4, H5, H6, H7, H8, H10, H12
- 75 mm: H4, H5, H6, H7, H8, H10, H12
- 30 mm: M5, 6, 8, 10, 12
- 75 mm: M5, 6, 8, 10, 12



**25 years**  
GUARANTEE

**S2**  
steel

**1/2"**

**3/8"**

**x40**



Ref.	☒	EAN
06-107	0/10	5907558414424



## Końcówki wkrętakowe

Driver bits / Einsätze für Schraubendreher / Насадки / Наконечники викрутки / Dugókulcs bitkészlet / Set biti / Šroubovákové nástavce / Skrutkovacie nástavce / Nastavki za izvijače / Atsuktuvo antgaliai / Skrūvgrieta užgalį / Krivikeerajaotsakud / Накрайници за отвёртка / Nastavci za odvijač / Nastavci za odvijač / Καταβιδόμετες / Puntas destornilladoras / Inserti lunghi e corti / Ponteiros Chave de fenda / Embouts de tournevis / Schroeendraaiereindstukken

**NEO**  
TOOLS

H7, H10, H11, H13, H14, H17, H19, H22, H24  
TS10, TS15, TS20, TS25, TS27, TS30, TS40, TS45, TS50  
T30, T40, T45, T50, T55, T60, T70, T80  
M9, M10, M12, M14, M16  
R7, R8, R9, R10  
H5



Ref.	☒	EAN
08-710	0/3	5907558417104



**NEO**  
TOOLS



Ref.	Info	L[mm]	☒	EAN
10-970	H5	30	50/200	5907558452884
10-972	H6	30	50/200	5907558452891
10-978	H12	30	50/200	5907558452907
10-980	H5	75	30/120	5907558452914
10-982	H6	75	30/120	5907558452921
10-988	H12	75	30/120	5907558452938

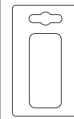

**NEO**  
TOOLS



Ref.	Info	L[mm]	☒	EAN
10-920	T30	30	50/200	5907558452785
10-922	T40	30	50/200	5907558452792
10-924	T45	30	50/200	5907558452808
10-926	T50	30	50/200	5907558452815
10-928	T55	30	50/200	5907558452822
10-940	T30	75	30/120	5907558452839
10-942	T40	75	30/120	5907558452846
10-944	T45	75	30/120	5907558452853
10-946	T50	75	30/120	5907558452860
10-948	T55	75	30/120	5907558452877
10-960	T100	75	20/40	5907558452945

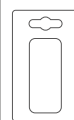

**NEO**  
TOOLS



Ref.	Info	L[mm]	☒	EAN
10-900	M8	30	50/200	5907558452723
10-902	M10	30	50/200	5907558452730
10-904	M12	30	50/200	5907558452747
10-906	M8	75	30/120	5907558452754
10-908	M10	75	30/120	5907558452761
10-910	M12	75	30/120	5907558452778

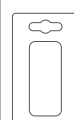

**TOP TOOLS**



T20, T25, T30, T40, T45, T50, T55, H4, H5, H6, H7,  
H8, H10, H12, M5, M6, M7, M8, M10, M12

L - 30 mm

T20, T25, T30, T40, T45, T50, T55, H4, H5, H6, H7,  
H8, H10, H12, M5, M6, M7, M8, M10, M12

L - 75 mm

x40

CrV

3/8"

1/2"



Ref.	☒	EAN
39D377	0/10	5902062050571



## Klucze sześciokątne

Hex key set / Sechskantschlüssel / Ключи шестигранные / Ключ шестигранный / Imbuskulcs készlet / Set chei cu șase laturi / Šestihraný klíč / Súprava imbus kľúčov (dlhé) / Garnitura imbus kľučev / Šešakampij raktu komplektas / Seškanšu atslėgiu kompleks / Kuuskant-mutrivõtmete komplekt / Лымбусы компл. / Kľjuč imbus set / Kľjuč imbus set / Συλλογή εξαγωνικών κλειδιών / Llaves Allen / Chiavi esagonali / Chaves hexagonais / Clefs à 6 pans / Zeskantsleutels

**NEO TOOLS**

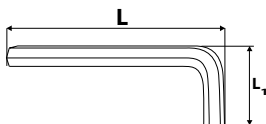

Ref.	Ø [mm]	L [mm]	L <sub>1</sub> [mm]	⊠	EAN
09-530	1.5	77	14	0/1500	5907558414004
09-531	2.0	81	16	0/1500	5907558414011
09-532	2.5	87	18	0/1500	5907558414028
09-533	3.0	94	20	0/1500	5907558414035
09-534	4.0	103	24	0/1000	5907558414042
09-535	4.5	108	26	0/800	5907558414059
09-536	5.0	115	28	0/500	5907558414066
09-537	5.5	122	30	0/500	5907558414073
09-538	6.0	129	32	0/500	5907558414080
09-539	7.0	136	34	0/300	5907558414097
09-540	8.0	147	36	0/200	5907558414103
09-541	9.0	159	38	0/200	5907558414110
09-542	10.0	170	40	0/150	5907558414127
09-543	12.0	190	45	0/80	5907558414134
09-544	13.0	205	48	0/80	5907558414141
09-545	14.0	216	54	0/60	5907558414158
09-546	17.0	245	63	0/40	5907558414165

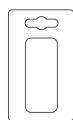

**NEO TOOLS**



Ø [mm]	L [mm]	L <sub>1</sub> [mm]
2.0	85	18
2.5	90	20
3.0	97	23
4.0	106	28
5.0	118	30
6.0	138	36
8.0	159	40
10.0	180	46

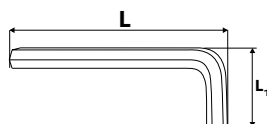

Ref.	⊠	EAN
09-523	10/40	5907558414288

**NEO TOOLS**



Ø [mm]	L [mm]	L <sub>1</sub> [mm]
1.5	92	15
2.0	100	18
2.5	114	20
3.0	127	22
4.0	143	28
5.0	164	31
6.0	185	37
8.0	205	43
10.0	235	47

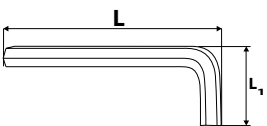

Ref.	⊠	EAN
09-525	6/24	5907558414301

**NEO TOOLS**

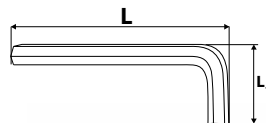

Ø [mm]	L [mm]	L <sub>1</sub> [mm]
1.5	91	16
2.0	103	19
2.5	115	20
3.0	130	23
4.0	145	29
5.0	166	35
6.0	188	38
8.0	208	43
10.0	230	50



Ref.	⊠	EAN
09-512	6/48	5907558403428

**NEO TOOLS**



Ø [mm]	L [mm]	L <sub>1</sub> [mm]
1.5	63	15
2.0	75	17
2.5	87	20
3.0	90	23
4.0	100	27
5.0	116	32
6.0	137	37



Ref.	⊠	EAN
09-517	10/100	5907558410273

**NEO TOOLS**



Ø [mm]	L [mm]	L <sub>1</sub> [mm]
1.5	92	15
2.0	100	18
2.5	114	20
3.0	127	22
4.0	143	28
5.0	164	31
6.0	185	37
8.0	205	43
10.0	235	47

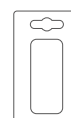

Ref.	⊠	EAN
09-515	12/48	5907558409314

**NEO TOOLS**

1.5-2-2.5-3-4-5-6-8 mm



Ref.	⊠	EAN
09-571	6/24	5907558450460



## Klucze sześciokątne

Hex key set / Sechskantschlüssel / Ключи шестигранные / Ключ шестигранный / Imbuszkulcs készlet / Set chei cu șase laturi / Šestihrannyj klíč / Súprava imbus klúčov (dlhé) / Garnitura imbus ključev / Šešikampij raktų komplektas / Seškanšu atslēgu komplekts / Kuuskant-mutrivõtmete komplekt / Лимбуси компл. / Ključ imbus set / Ključ imbus set / Συλλογή εξαγωνικών κλειδιών / Llaves Allen / Chiavi esagonali / Chaves hexagonais / Clefs à 6 pans / Zeskantsleutels

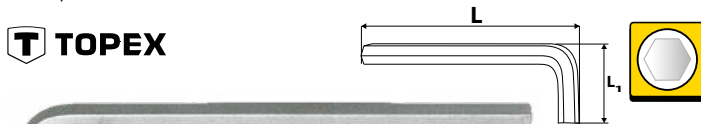

**TOPEX**

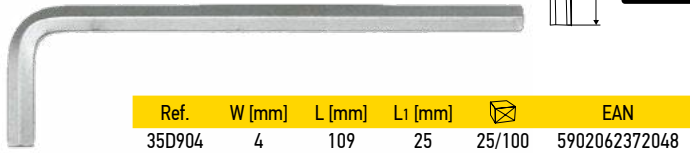

Ref.	W [mm]	L [mm]	L1 [mm]	☒	EAN
35D904	4	109	25	25/100	5902062372048
35D905	5	120	28	150/600	5902062372055
35D906	6	134	32	100/400	5902062372062
35D907	7	142	34	80/320	5902062372079
35D908	8	149	36	45/180	5902062372086
35D910	10	170	40	25/100	5902062372109
35D912	12	195	44	20/80	5902062372123
35D913	13	223	46	15/60	5902062372130
35D914	14	255	49	10/40	5902062372147
35D917	17	290	53	4/24	5902062372178
35D919	19	330	56	3/18	5902062372192

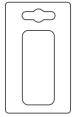

**TOPEX** ● 1,5; 2; 2,5; 3; 4; 5; 6; 8; 10 mm

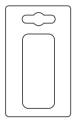
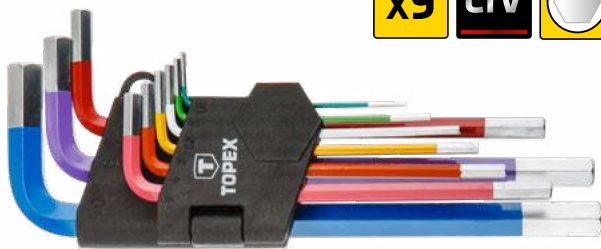

Ref.	☒	EAN
35D966	12/36	5902062005960

**TOPEX** ● 1,5; 2; 2,5; 3; 4; 5; 6; 8; 10 mm

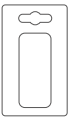

Ref.	☒	EAN
35D955	10/40	5902062371102

**TOPEX** ● 1,5; 2; 2,5; 3; 4; 5; 6; 8; 10 mm

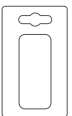

Ref.	☒	EAN
35D956	12/36	5902062371201

**TOPEX** ● 1,5; 2; 2,5; 3; 4; 5; 6; 8; 10 mm

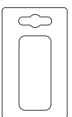

Ref.	☒	EAN
35D957	12/36	5902062371300

**TOPEX** ● 1,5; 2; 2,5; 3; 4; 5; 5,5; 6; 8; 10 mm

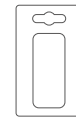

Ref.	☒	EAN
35D954	10/60	5902062359544

**TOPEX**

● 1,5; 2; 2,5; 3; 4; 5; 6; 8; 10 mm

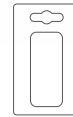

Ref.	☒	EAN
35D962	6/36	5902062359629

**TOPEX** ● 1,5; 2; 2,5; 3; 4; 5; 5,5; 6 mm

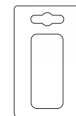

Ref.	☒	EAN
35D958	10/100	5902062359582

**TOPEX**

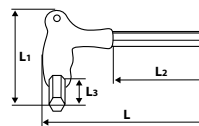

● [mm]	L [mm]	L1 [mm]	L2 [mm]	L3 [mm]
2	150	65	100	11
2,5	150	65	100	11
3	150	65	100	11
4	150	65	100	11
5	215	90	150	16
6	215	90	150	16
8	280	115	200	20
10	280	115	200	20



Ref.	☒	EAN
35D967	0/20	5902062359674



## Klucze sześciokątne

Hex key set / Sechskantschlüssel / Ключи шестигранные / Ключ шестигранный / Imbuskulcs készlet / Set chei cu șase laturi / Šestihránný klíč / Súprava imbus klúčov / Garnitura imbus ključev / Šešakampij raktų komplektas / Seškanšu atslėgu komplekts / Kuuskant-mutrivõtmete komplekt / Лимбуси компл. / Ključ imbus set / Ključ imbus set / Συλλογή εξαγωνικών κλειδιών / Llaves Allen / Chiavi esagonali / Chaves hexagonais / Clefs à 6 pans / Zeskantsleutels

**T TOPEX**

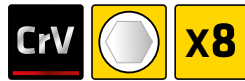

**TOP TOOLS**

2, 2.5, 3, 4, 5, 6, 8, 10 mm

**x8**



● (mm)	L (mm)	L1 (mm)	L2 (mm)	L3 (mm)
2	135	55	100	15
2,5	135	55	100	15
3	135	55	100	15
4	135	55	100	15
5	200	70	150	20
6	200	70	150	20
8	260	85	200	20
10	260	85	200	20

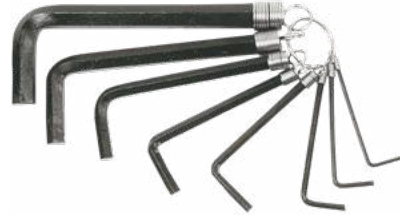
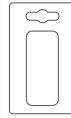

Ref. EAN  
35D055 45/90 5902062040817

Ref. EAN  
35D963 0/10 5902062359636

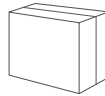

**TOP TOOLS**

1.5, 2, 2.5, 3, 4, 5, 6, 8, 10 mm

**x9**

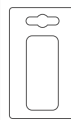

Ref. EAN  
35D051 12/48 5902062004727

## Klucze Torx

Torx key wrench set / Torx-Schlüssel / Ключи Torx / Ключи "Torx" / Torx kulcskészlet / Set chei de tip "torx" / Klíče Torx / Súprava Torx klúčov / Garnitura ključev torx / Raktai TORX / Torx atslėgu komplekts / "Torx" mutrivõtmete komplekt / Лимбуси компл. / Ključ imbus / Кλειδιά Torx / Llaves torx / Set chiavi Torx / Chaves torx / Clefs Torx / Torxsleutels

**NEO TOOLS**

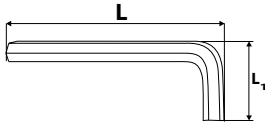

**NEO TOOLS**



Ref.	●	L[mm]	L <sub>1</sub> [mm]		EAN
09-550	T10	77	14	0/1500	5907558414172
09-551	T15	84	16	0/1500	5907558414189
09-552	T20	92	18	0/1000	5907558414196
09-553	T25	101	20	0/1000	5907558414202
09-554	T27	111	24	0/500	5907558414219
09-555	T30	122	28	0/500	5907558414226
09-556	T40	136	32	0/400	5907558414233
09-557	T45	152	36	0/300	5907558414240
09-558	T50	176	40	0/200	5907558414257
09-559	T55	183	44	0/100	5907558414264

●	L[mm]	L <sub>1</sub> [mm]
T10	89	20
T15	105	22
T20	115	23
T25	130	25
T27	146	30
T30	167	35
T40	184	38
T45	204	45
T50	226	50

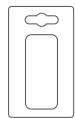
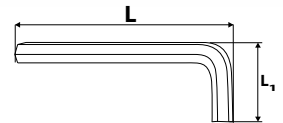

Ref. EAN  
09-518 6/48 5907558420661

**NEO TOOLS**



**NEO TOOLS**



●	L[mm]	L <sub>1</sub> [mm]
TT10	88	20
TT15	93	22
TT20	98	23
TT25	105	24
TT30	119	30
TT40	130	32
TT45	144	37
TT50	160	40

●	L[mm]	L <sub>1</sub> [mm]
TT10	88	20
TT15	93	22
TT20	98	23
TT25	105	24
TT30	119	30
TT40	130	32
TT45	144	37
TT50	160	40

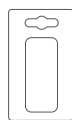
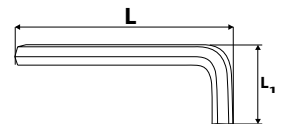
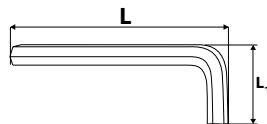

Ref. EAN  
09-514 6/36 5907558403428

Ref. EAN  
09-524 10/40 5907558414295



## Klucze Torx

Torx key wrench set / Torx-Schlüssel / Ключи Torx / Ключи "Torx" / Torx kulcskészlet / Set chi de tip "torx" / Ключи Torx / Súprava Torx klíčův / Garnitura ključev torx / Raktai TORX / Torx atslėgu komplekts / "Torx" mutrivõtmete komplekt / Лумбџи компл. / Ključ imbus / Κλειδιά Torx / Llaves torx / Set chiavi Torx / Chaves torx / Clefs Torx / Torxsleutels

**NEO**  
TOOLS

25  
years  
GUARANTEE

TÜV Rheinland  
CERTIFIED

S2  
steel

x9



⊛ L[mm] L<sub>1</sub>[mm]

T10	89	20
T15	105	22
T20	115	23
T25	130	25
T27	146	30
T30	167	35
T40	184	38
T45	204	45
T50	226	50

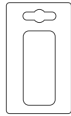
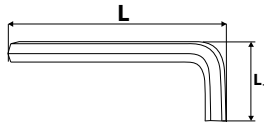

Ref. 09-516 EAN 5907558409321

**NEO**  
TOOLS

25  
years  
GUARANTEE

CrV  
steel

x9



⊛ L[mm] L<sub>1</sub>[mm]

T10	89	20
T15	105	22
T20	115	23
T25	130	25
T27	146	30
T30	167	35
T40	184	38
T45	204	45
T50	226	50

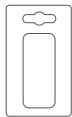
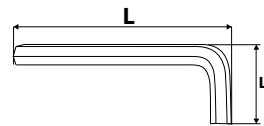

Ref. 09-526 EAN 5907558414318

**NEO**  
TOOLS

⊛ T9; T10; T15; T20; T25; T27; T30; T40

25  
years  
GUARANTEE

180°  
135°  
90°

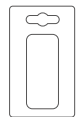

Ref. 09-573 EAN 5907558450477

**TOPEX**

CrV



x9



⊛ L[mm] L<sub>1</sub>[mm] L<sub>2</sub>[mm] L<sub>3</sub>[mm]

T10	150	65	100	11
T15	150	65	100	11
T20	150	65	100	11
T25	200	65	150	11
T27	200	65	150	15
T30	210	90	150	15
T40	210	90	150	15
T45	280	115	200	20
T50	280	115	200	20

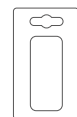
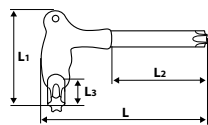

Ref. 35D968 EAN 5902062359681

**TOPEX**

⊛ T10; T15; T20; T25; T27; T30; T40; T45; T50

CrV



x9



Ref. 35D969 EAN 5902062005977

**TOPEX**

⊛ T10, T15, T20, T25, T27, T30, T40, T45, T50

CrV



x9

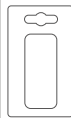

Ref. 35D961 EAN 5902062359612  
35D960 10/40 5902062371409

**TOPEX**

CrV



x9

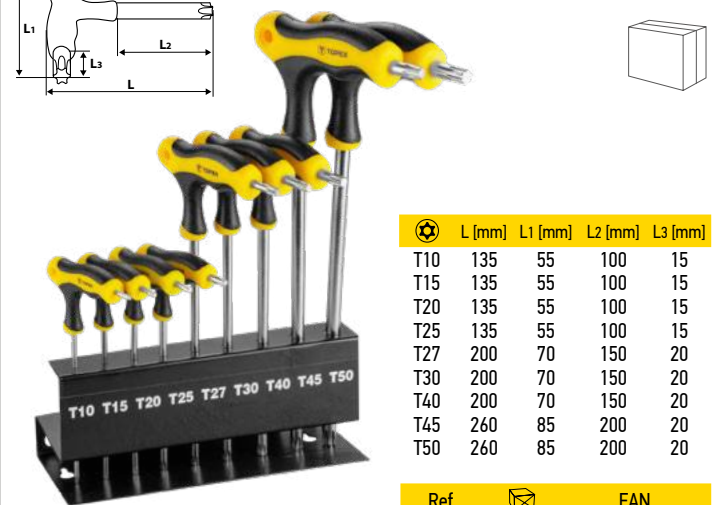
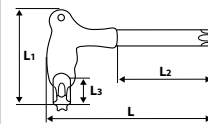

⊛	L[mm]	L <sub>1</sub> [mm]	L <sub>2</sub> [mm]	L <sub>3</sub> [mm]
T10	135	55	100	15
T15	135	55	100	15
T20	135	55	100	15
T25	135	55	100	15
T27	200	70	150	20
T30	200	70	150	20
T40	200	70	150	20
T45	260	85	200	20
T50	260	85	200	20

Ref. 35D964 EAN 5902062359643

**TOPEX**

⊛ T9, T10, T15, T20, T25, T27, T30, T40

CrV



x8



Ref. 35D959 EAN 5902062359599





## Klucze sześciokątne i Torx

Hexagonal and Torx wrenches / Sechskant- und Torx-Schlüssel / Шестигранные ключи и Torx / Ключи шестигранный и «Торх» / Imbusz és Torx kulcs készlet / Chei hexagonale și Torx / Šestihránné a Torx klíče / Šestihránné a torxové klíče / Kľučí inbus in torx / Torciniai raktai / Sešstūra atslēgas un Torx atslēgas / Kuuskant- ja Torx-võtmed / Шестоголenni ключове и торкс / Šesterokutni ključeví i Torx / Imbus i Torx ključ / Εξάγωνα κλειδιά και κλειδιά Torx / Llaves hexagonales y torx / Chiavi esagonali e Torx / Chaves hexagonais e Torx / Clefs à 6 pans et Torx / Zeskant en Torx sleutels

**TOPEX**



1.5, 2, 2.5, 3, 4, 5, 6, 8, 10 mm

T10, T15, T20, T25, T27, T30, T40, T45, T50



Ref.	📦	EAN
35D952	6/24	5902062359520

## Kluczyk uniwersalny do szafek

Universal control cabinet key / Universalschlüssel für Schränke / Ключ универсальный для шкафов / Ключ универсальный до шаф / Chiave universale per armadietti / Cheie univesala pentru dulapuri / Univerzální klíč na rozvodné skříně / Univerzálny klúčik na skrinky / Univerzalni ključ za električne omarice / Elektros spintelių raktas, universalus / Univeršala atslēga skapjiem / Univeršaalne karinvõti / Универсален ключ за шкафчета / Univerzalni ključ za ormare / Univerzalni ključ / Кλειδιά γενικής χρήσης για ντουλάπια εργασιών / Llave universal para armarios / Chiave universale per armadietti / Chave universal para armários / Clé pour armoires universelle

**NEO TOOLS**



Ref.	📦	EAN
02-001	50/200	5907558404319

**NEO TOOLS**

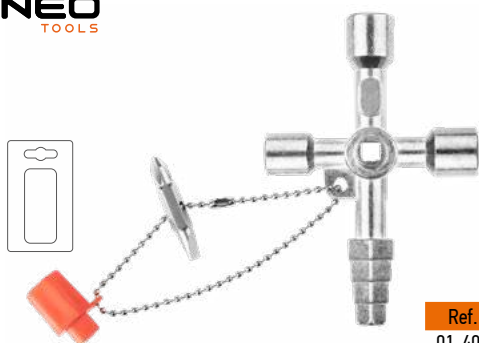

Ref.	📦	EAN
01-402	24/192	5907558449631

## Klucze pięciokątne

Pentagonal wrenches / Fünfkantschlüssel / Пятигранные ключи / Ключи-звочки / Torx kulcskészlet / Chei pentagonale / Pětihránné klíče / Päthránné klíče / Kľučí zvezda / Penkiakampiai raktai / Piecstūra atslēgas / Viiskantvõtmed / Петоголenni ключове / Peterokutni ključeví / Petougaoni ključ / Πεντάγωνα κλειδιά / Llaves pentagonales / Chiavi pentagonali TS / Chaves de cinco ângulos / Clefs à 5 pans / Vijfkant sleutels

**TOPEX** TS10, TS 15, TS 20, TS 25, TS 27, TS30, TS 40, TS 45, TS 50

**CrV**



x9

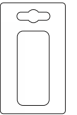

Ref.	📦	EAN
35D951	6/36	5902062359513
35D950	6/36	5902062359506

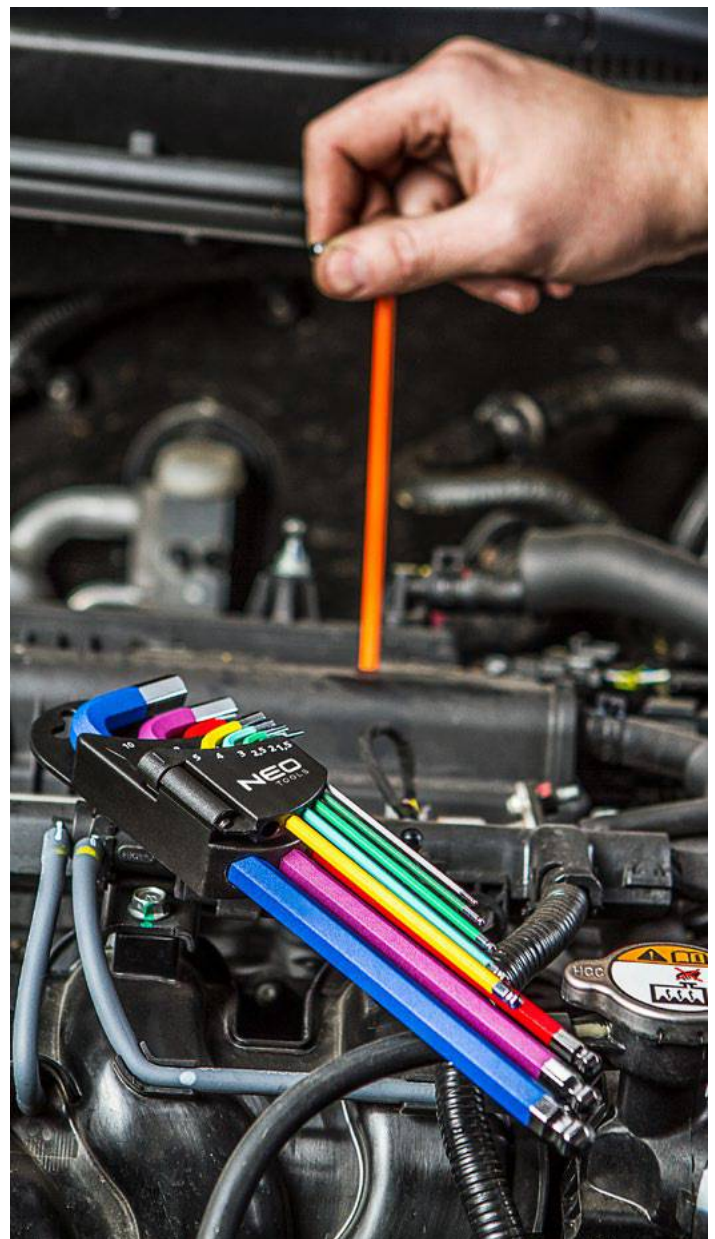

## Klucz dynamometryczny

Torque wrench / Drehmomentschlüssel / Ключ динамометрический / Ключ динамометричний / Nyomatékkulcs / Cheie dinamometrică / Dynamometrický klíč / Dynamometrický ključ / Dinamometrični ključ / Dinamometrinis raktas / Dinamometriska atslēga / Dinamoetriiline võti / Динамометричен ключ / Dinamometrički ključ / Obrtni ključ / Δυναμομετρικό κλειδί / Llave dinamométrica / Chiave dinamometrica / Chave dinamométrica / Clef dynamométrique / Dynamometrische sleutel

**NEO**  
TOOLS

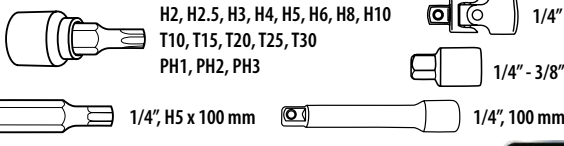

Ref.	Info	⊠	EAN
08-821	0/12		5907558458954

**NEO**  
TOOLS



Ref.	Info	⊠	EAN
08-835	40-220Nm	0/6	5907558458930
08-837	60-330Nm	0/6	5907558458947

**NEO**  
TOOLS



Ref.	Info	⊠	EAN
08-823	3/8", 10 – 60 Nm	1/10	5907558444544
08-824	3/8", 20 – 100 Nm	1/10	5907558444551
08-825	1/2", 40 – 200 Nm	1/10	5907558444568
08-826	1/2", 60 – 350 Nm	1/4	5907558444599

**NEO**  
TOOLS



Ref.	Info	⊠	EAN
08-827	1/2", 20 – 210 Nm	1/10	5907558444575
08-828	1/2", 60 – 350 Nm	1/10	5907558444582

**NEO**  
TOOLS



Ref.	Info	⊠	EAN
08-822	5-25Nm	1/20	5907558471168

**NEO**  
TOOLS



Ref.	Info	⊠	EAN
08-838	160-800Nm	1/2	5907558469745
08-839	20-1000Nm	1/2	5907558469752

**NEO**  
TOOLS



Ref.	Info	⊠	EAN
08-843	5-350Nm	1/4	5907558471168

**NEO**  
TOOLS



Ref.	Info	⊠	EAN
08-845	5-330Nm	1/2	5907558463538



## Klucz dynamometryczny

Torque wrench / Drehmomentschlüssel / Ключ динамометрический / Ключ динамометричний / Nyomatékkulcs / Cheie dinamometrică / Dynamometrický kľúč / Dynamometrický ključ / Dinamometrični kľuč / Dinamometrins raktas / Dinametriska atslēga / Dünamoetriline võti / Динамометричен ключ / Dinamometrički kľjuč / Obrtni kľjuč / Δυναμομετρικό κλειδί / Llave dinamométrica / Chiave dinamometrica / Chave dinamométrica / Clef dynamométrique / Dynamometrische sleutel



1/2"

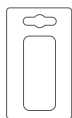

Ref.	Info	📦	EAN
37D105	0-200 Nm	6/24	5902062040718

## Kątomierz do dokręcania śrub

Torque angle gauge / Winkelmesser zum schraubenanziehen / Угломер для затяжки болтов / Нутомір для дозвинування гвинтів / Szögmérő csavar meghúzáshoz / Raportor la strângerea șuruburilor / Uhloměr k utahování šroubů / Uhlomer krútiaceho momentu / Kotomer za privijanje vijakov / Varčtu užspaidimo katro matuoklis / Leņķmērs skrūvju pievilkšanai / Nurgamõõdik poltide pingutamiseks / Ёломер за динамометричен ключ / Kutomjer za zatezanje vijaka / Uglomer za zavrtnanje šrafova / Γωνιόμετρο αόφιξης βιδών / Escuadra para atornillar tornillos / Goniometro per avvitare le viti / Transferidor para aparafusar / Clé de serrage angulaire



1/2"

360°



Ref.	📦	EAN
08-830	1/12	5907558416770

## Klucz płasko-oczkowy

Combination spanner / Maul-Ringschlüssel / Ключ комбинированный / Ключ комбінований, ріжково-накіндний / Csillag-villáskulcs / Cheie combinată / Kľúč očko-plochý / Ključ OP / Kľjuč viličasto-obročni / Raktas plokščias - kilpinis / Kombinētā atslēga / Universaalne mutrivõti / Ключ звездозаечен / Kľjuč kombinirani / Kľjuč kombinovani / Γερανοαπόλύγιο / Llave combinada / Chiave combinata / Chave plana-de luneta / Clef à fourche-polygonale / Moersleutel



Ref.	● [mm]	L [mm]	📦	EAN	Ref.	● [mm]	L [mm]	📦	EAN
09-706	6	100	0/200	5907558410914	09-722	22	260	5/50	5907558411072
09-707	7	110	5/200	5907558410921	09-723	23	260	5/30	5907558411089
09-708	8	120	5/200	5907558410938	09-724	24	280	5/50	5907558411096
09-709	9	130	5/200	5907558410945	09-725	25	295	5/40	5907558411102
09-710	10	140	5/200	5907558410952	09-727	27	310	5/50	5907558411126
09-711	11	150	5/200	5907558410969	09-728	28	310	5/40	5907558411133
09-712	12	160	5/200	5907558410976	09-729	29	340	4/40	5907558411140
09-713	13	170	5/200	5907558410983	09-730	30	340	4/30	5907558411157
09-714	14	180	5/100	5907558410990	09-732	32	360	4/40	5907558411164
09-715	15	190	5/100	5907558411003	09-734	34	380	4/20	5907558411171
09-716	16	200	5/100	5907558411010	09-736	36	410	5/10	5907558412611
09-717	17	210	5/100	5907558411027	09-738	38	430	5/20	5907558412628
09-718	18	220	5/100	5907558411034	09-741	41	460	2/10	5907558412635
09-719	19	230	5/100	5907558411041	09-746	46	500	5/10	5907558412642
09-720	20	240	5/100	5907558411058	09-747	50	540	5/10	5907558412659
09-721	21	250	5/100	5907558411065	09-749	60	600	0/2	5907558412673

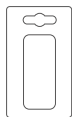
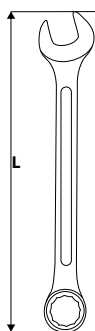

Ref.	● [mm]	L [mm]	📦	EAN
09-406	6	100	25/400	5907558422375
09-407	7	110	25/400	5907558422382
09-408	8	120	25/400	5907558422399
09-409	9	130	25/400	5907558422405
09-410	10	140	25/400	5907558422412
09-411	11	150	25/300	5907558422429
09-412	12	160	25/300	5907558422436
09-413	13	170	25/300	5907558422443
09-414	14	180	25/200	5907558422450
09-415	15	190	25/200	5907558422467
09-416	16	200	25/150	5907558422474
09-417	17	210	25/150	5907558422481
09-418	18	220	10/120	5907558422498
09-419	19	230	10/120	5907558422504
09-421	21	250	10/100	5907558422528
09-422	22	260	10/100	5907558422535
09-424	24	280	10/80	5907558422559
09-427	27	310	10/40	5907558422580
09-429	29	340	10/40	5907558422603
09-430	30	340	10/40	5907558422610
09-432	32	360	10/40	5907558422627

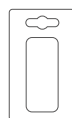

Ref.	● [mm]	L [mm]	📦	EAN
09-650	6	100	1/25	5907558467482
09-651	7	110	1/25	5907558467499
09-652	8	120	1/25	5907558467505
09-653	9	130	1/25	5907558467512
09-654	10	140	1/25	5907558467529
09-655	11	150	1/25	5907558467536
09-656	12	160	1/25	5907558467543
09-657	13	170	1/25	5907558467550
09-658	14	180	1/25	5907558467557
09-659	15	190	1/25	5907558467564
09-660	16	200	1/25	5907558467571
09-661	17	210	1/25	5907558467578
09-662	18	220	1/10	5907558467604
09-663	19	230	1/10	5907558467611
09-665	21	250	1/10	5907558467628
09-666	22	260	1/10	5907558467635
09-668	24	280	1/10	5907558467642
09-671	27	310	1/10	5907558467659
09-672	29	340	1/10	5907558467666
09-674	30	340	1/10	5907558467673
09-675	32	360	1/10	5907558467680

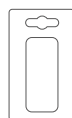

## Klucz płasko-oczkowy

Combination spanner / Maul-Ringschlüssel / Ключ комбинированный / Ключ комбінований, ріжково-накидний / Csillag-villáskulcs / Cheie combinată / Klíč očko-plochý / Ključ OP / Kļuč vilīčasto-obročni / Raktas plokščias - kilpinis / Kombinētā atslēga / Universaalne mutrivõti / Ключ звездогоачен / Кљуц kombinirani / Кљуц kombinovani / Γερμανοπλόγωνα / Llave combinada / Chiave combinata / Chave plana-de luneta / Clef à fourche-polygonale / Moersleutel

NEO  
TOOLS

25  
years  
GUARANTEE

TÜV Rheinland  
CERTIFIED

CrV  
steel

DIN  
3113

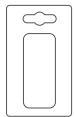
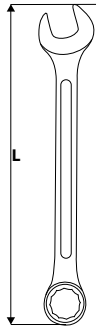

Ref.	● [mm]	L [mm]	☒	EAN
09-760	8	90	10/200	5907558410198
09-761	9	93	5/200	5907558410204
09-762	10	96	5/200	5907558410211
09-763	11	98	10/200	5907558410228
09-764	12	102	10/200	5907558410235
09-765	13	109	5/200	5907558410242
09-766	14	113	10/200	5907558410259
09-767	15	118	10/120	5907558410266
09-768	16	123	10/120	5907558412765
09-769	17	129	10/200	5907558412772
09-770	18	131	10/120	5907558412789
09-771	19	134	10/150	5907558412796

NEO  
TOOLS

25  
years  
GUARANTEE

TÜV Rheinland  
CERTIFIED

CrV  
steel

x8  
DIN  
3113

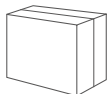

Ref.	● [mm]	☒	EAN
09-791	8, 9, 10, 12, 13, 14, 17, 19	0/20	5907558413090

TOPEX



Ref.	● [mm]	L [mm]	☒	EAN
35D380	6	100	25/400	5902062004789
35D381	7	100	25/400	5902062004796
35D382	8	110	25/300	5902062004802
35D383	10	125	25/300	5902062004819
35D384	12	140	25/200	5902062004826
35D385	13	145	25/200	5902062004833
35D386	14	160	25/200	5902062004840
35D387	15	175	25/200	5902062004857
35D388	16	185	20/160	5902062004864
35D389	17	205	20/120	5902062004871
35D390	18	205	20/120	5902062004888
35D391	19	230	20/120	5902062004895
35D392	22	260	20/80	5902062004901
35D393	24	280	20/60	5902062004918
35D394	27	310	10/40	5902062004925
35D395	30	360	10/30	5902062004932
35D396	32	380	10/30	5902062004949

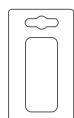

NEO  
TOOLS

25  
years  
GUARANTEE

TÜV Rheinland  
CERTIFIED

CrV  
steel

DIN  
3113

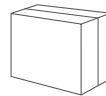

Ref.	● [mm]	N	☒	EAN
09-750	6, 8, 10, 13, 15, 17	x6	0/25	5907558411515
09-751	6, 8, 10, 12, 13, 14, 17, 19	x8	0/25	5907558411522
09-752	6, 7, 8, 10, 11, 12, 13, 14, 15, 17, 19, 22	x12	0/20	5907558411539
09-753	8, 9, 10, 11, 12, 13, 14, 15, 16, 17, 18, 19, 22, 24, 27, 30, 32	x17	0/6	5907558413106
09-754	6, 7, 8, 9, 10, 11, 12, 13, 14, 15, 16, 17, 18, 19, 20, 21, 22, 23, 24, 25, 26, 27, 28, 29, 30, 32	x26	0/4	5907558413113

TOPEX



Ref.	● [mm]	N	☒	EAN
35D374	6; 8; 10; 12; 13; 15; 17; 19	x8	5/30	5902062005168
35D375	6; 7; 8; 9; 10; 11; 12; 13; 15; 17; 19; 22	x12	5/20	5902062005175

TOPEX

CrV



Ref.	● [mm]	N	☒	EAN
35D397	8; 10; 12; 13; 15; 17	x6	5/40	5902062004956



## Klucz płasko-oczkowy

Combination spanner / Maul-Ringschlüssel / Ключ комбинированный / Ключ комбінований, ріжково-накидний / Csillag-villáskulcs / Cheie combinată / Кліч очко-плочь / Кліч ОР / Кліч вилічasto-оброчни / Raktas plokščias - kilpinis / Kombinētā atslēga / Universaalhe nutrivöti / Ключ звездогаечен / Кліч комбинирани / Кліч комбиновани / Γερμανοαπόλυγωνα / Llave combinada / Chiave combinata / Chave plana-de luneta / Clef à fourche-polygonale / Moersleutel

**TOPEX**

**CrV**



Ref.	● [mm]	N	📦	EAN
35D755	8, 10, 12, 13, 14, 17	x6	4/40	5902062044624
35D756	6, 8, 10, 12, 13, 14, 17, 19	x8	4/32	5902062044631
35D757	6, 7, 8, 9, 10, 11, 12, 13, 14, 17, 19, 22	x12	2/20	5902062044648

**TOPEX**

**CrV**

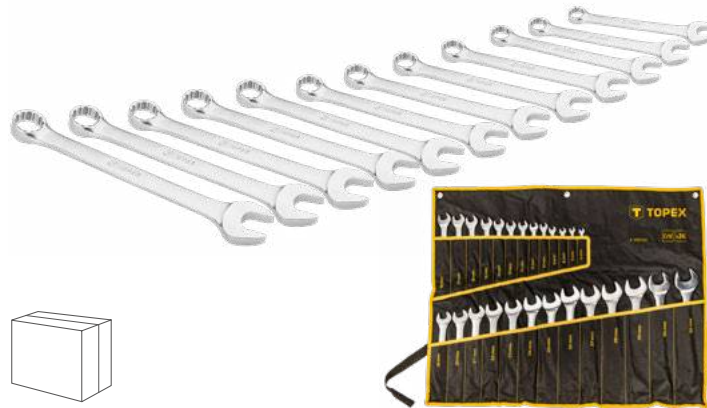

Ref.	● [mm]	N	📦	EAN
35D759	6, 8, 10, 12, 13, 14, 17, 19	8	4/24	5902062049513
35D758	13, 14, 15, 16, 17, 18, 19, 22, 24, 27, 30, 32	12	0/6	5902062357588
35D763	6, 7, 8, 9, 10, 11, 12, 13, 14, 15, 16, 17, 18, 19, 20, 21, 22, 23, 24, 25, 26, 27, 28, 29, 30, 32	26	0/4	5902062049520

**TOP TOOLS**

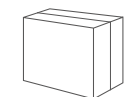

Ref.	● [mm]	N	📦	EAN
35D355	8-17	x6	15/60	5902062040428
35D356	6-19	x8	10/40	5902062040442
35D357	6-22	x12	5/20	5902062201850
35D359	6-22	x12	0/20	5902062353597
35D360	6-19	x8	0/30	5902062353603
35D370	6-32	x25	0/4	5902062040466

## Klucz płaski jednostronny

Open single end spanner / Maulschlüssel einseitig / Ключ рожковый одностронный / Ключ ріжковий / Villáskulcs / Cheie piulită unilaterală cu cavitatea deschisă / Плочь кліч jednostranný / Кліч видлицовй jednostranný / Viličasti ključ / Plokščias vienpusis raktas / Ragatslēga / Ūhe avatud otsaga vöti / Ключ Гаечен / Кліч виљушкasti / Кліч виљушкasti / Movó γερμανικό κλειδί / Llave fija de una boca / Chiave a forchetta / Chave plana / Clef à fourche simple / Eenzijdig vlakke sleutel

**TOPEX**

**CrV**

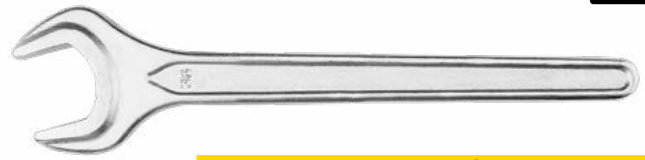

Ref.	● [mm]	L [mm]	📦	EAN
35D630	36	300	5/40	5902062356307
35D632	41	300	4/40	5902062356321
35D633	46	370	5/20	5902062356338
35D635	55	440	4/16	5902062356352
35D636	60	480	4/12	5902062356369

## Klucz płasko-oczkowy z grzechotką

Combination spanner with ratchet / Ringschlüssel mit Ratsche / Ключ комбинированный с трещоткой / Ключ ріжково-накидний з трісчаткою / Csillag-villáskulcs racsnis / Cheie fixă -inelară cu clichet / Očkoplochý klíč ráčnový / Плочь-оцковй кліч с рацію / Ploščato-obročni ključ z ragljo / Raktas plokščias, kilpinis su terkšle / Kombinētā atslēga / Kāristīga leht-silmsvöti / Комбинирана трещотка / Posnato-okasti ključ s nastavkom / Pļosnato-okasti ključ sa čegrtaljkom / Κλειδί γερμανοαπόλυγωνα με καστίνα / Llaves combinadas (de estrella y a carraca abierta) con carraca / Chiave combinata a cricchetto / Chave plana-de luneta z catraca de furar / Clef à fourche-polygonale à cliquet / Moersleutel met ratel

**NEO TOOLS**

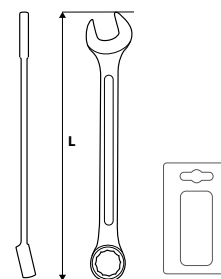

Ref.	● [mm]	L [mm]	📦	EAN
09-063	8	140	10/200	5907558424157
09-064	10	160	10/200	5907558416954
09-065	13	180	10/50	5907558416961
09-066	15	190	10/100	5907558416978
09-067	17	213	0/100	5907558416985
09-068	19	235	10/60	5907558416992
09-069	21	237	10/50	5907558424164
09-042	22	252	5/50	5907558424041
09-043	24	274	5/50	5907558424058
09-044	27	332	6/30	5907558424065
09-045	30	349	6/24	5907558424072

**NEO TOOLS**

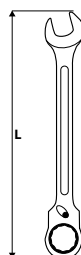

Ref.	● [mm]	L [mm]	📦	EAN
09-320	8 mm	20	10/100	5907558444919
09-321	9 mm	21	10/100	5907558444926
09-322	10 mm	22	10/100	5907558444933
09-323	11 mm	22	10/100	5907558444940
09-324	12 mm	23	10/100	5907558444957
09-325	13 mm	26	5/100	5907558444964
09-326	14 mm	27	5/100	5907558444971
09-327	15 mm	27	5/50	5907558444988
09-328	16 mm	28	5/50	5907558444995
09-329	17 mm	30	5/50	5907558445008
09-330	18 mm	31	5/50	5907558445015
09-331	19 mm	32	5/50	5907558445022
09-333	21 mm	38	5/50	5907558445046
09-334	22 mm	38	5/50	5907558445053
09-336	24 mm	42	5/25	5907558445077
09-338	26 mm	45	5/25	5907558445091
09-339	27 mm	45	5/25	5907558445107
09-340	28 mm	49	5/25	5907558445114
09-341	30 mm	49	5/20	5907558445121
09-342	32 mm	52	5/20	5907558445138



## Klucz płasko-oczkowy z grzechotką

Combination spanner with ratchet / Ringschlüssel mit Ratsche / Ключ комбинированный с трещоткой / Ключ ріжково-накидний з трісноткою / Csillag-villáskulcs racsnis / Cheie fixă –inelară cu clichet / Ožkoplochy klíč ráčnový / Plochy-očkový klíč s račňou / Ploščato-obročni ključ z ragljo / Raktas plokščias, klijpinis su terkšle / Kombinētā atslēga / Kõristiga leht-silmusvõti / Комбинурана трещотка / Plosnato-okasti ključ s nastavkom / Plosnato-okasti ključ sa čegrtaljkom / Κλειδί γερμανοπολύγωνο με κασάτνια / Llaves combinadas (de estrella y a carraca abierta) con carraca / Chiave combinata a cricchetto / Chave plana-de luneta z catraca de furar / Clef à fourche-polygonale à cliquet / Moersleutel met ratel

NEO TOOLS

25 years GUARANTEE

TÜV Rheinland CERTIFIED

72

CrV steel

DIN 3110

NEO TOOLS

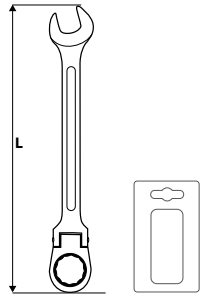

Ref.	● [mm]	L [mm]	📦	EAN
09-051	8	140	10/200	5907558403435
09-052	10	162	10/160	5907558403442
09-055	13	181	10/120	5907558403459
09-057	15	202	10/100	5907558403466
09-059	17	237	10/80	5907558403473
09-061	19	250	10/60	5907558403480
09-062	21	255	10/50	5907558424140
09-053	22	255	5/50	5907558424096
09-054	24	274	5/50	5907558424102
09-056	27	312	5/30	5907558424119
09-058	30	350	6/24	5907558424126
09-060	32	390	8/16	5907558424133

TOPEX

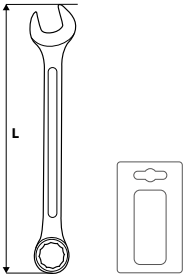

Ref.	● [mm]	L [mm]	📦	EAN
35D740	8	135	10/200	5902062357403
35D741	10	160	10/200	5902062357410
35D747	12	165	10/100	5902062357472
35D743	13	180	10/100	5902062357434
35D744	15	200	10/100	5902062357441
35D745	17	225	10/60	5902062357458
35D746	19	245	10/100	5902062357465
35D748	21	260	5/60	5902062023100
35D749	22	280	6/60	5902062023117
35D750	24	300	10/40	5902062023124

## Klucze płaskie dwustronne

Flat double sided wrenches / Mutterschlüssel, beidseitig / Ключи с открытым зевом двухсторонние / Ключі ріжкові двобічні / Villáskulcs készlet / Cheie fixa / Klíče ploché oboustranné / Klíče ploché obojstranné / Ploščati obojstranski ključji / Ploščiti raktai, dvipusiai / Divpusēja plakana atslēga / Каhepoolded lehtvõtmed / Плоски двусторонни ключове / Dvostrani plosnati ključevi / Dvočeljusni plosnati ključevi / Γερμανικό κλειδί διπλο / Llaves fijas dobles / Chiavi a forchetta doppia / Chaves planas de duas pontas / Clefs à fourches doubles / Vlakke tweezijdige sleutels

NEO TOOLS

25 years GUARANTEE

TÜV Rheinland CERTIFIED

CrV steel

DIN 3110

NEO TOOLS

SUPER THIN

x8

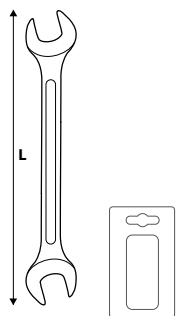

Ref.	● [mm]	L [mm]	📦	EAN
09-806	6x7	120	10/600	5907558411195
09-808	8x9	140	10/200	5907558411201
09-810	10x11	160	10/300	5907558411218
09-812	12x13	170	10/200	5907558411225
09-814	14x15	190	10/100	5907558411232
09-816	16x17	200	10/100	5907558411249
09-817	17x19	220	10/100	5907558411454
09-818	18x19	220	5/100	5907558411256
09-819	19x22	234	10/100	5907558411461
09-820	20x22	230	5/100	5907558411263
09-821	21x23	250	5/100	5907558411270
09-824	24x27	270	5/50	5907558411287
09-825	25x28	285	5/50	5907558411294



CrV steel

x12

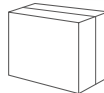

Ref.	● [mm]	📦	EAN
09-345	8, 9, 10, 11, 12, 13, 14, 15, 16, 17, 18, 19		5907558483093



Ref.	● [mm]	📦	EAN
09-860	5,5x7, 8x9, 10x12, 11x13, 14x17, 19x21, 22x23, 24x27	0/20	5907558458916



## Klucze płaskie dwustronne

Flat double sided wrenches / Mutterschlüssel, beidseitig / Ключи с открытым зевом двухсторонние / Ключі різнової двобічні / Villáskulcs készlet / Cheie fixa / Klíče ploché oboustranné / Klúče ploché obojstranné / Ploščati obojstranski ključji / Ploščiti rakati, dvipusiai / Divpusēja plakana atslēga / Каћероосед лећтвџтмед / Плоски двустранни ключоџе / Dvostrani plosnati ključjevi / Dvočeljusni pljosnati ključjevi / Γερμανικό κλειδί δίπλο / Llaves fijas dobles / Chiavi a forchetta doppia / Chaves planas de duas pontas / Clefs à fourches doubles / Vlakke tweezijdige sleutels

NEO  
TOOLS

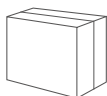

25  
years  
GUARANTEE

TUV  
Rheinland  
CERTIFIED

CrV  
steel

DIN  
3110

Ref.	● [mm]	N	☒	EAN
09-851	6x7, 8x9, 10x11, 12x13, 14x15, 16x17, 18x19, 20x22	8	0/20	5907558411546
09-852	6x7, 8x9, 10x11, 12x13, 14x15, 16x17, 18x19, 20x22, 21x23, 24x27, 25x28, 30x32	12	0/8	5907558413120

## TOPEX

CrV X8



Ref.	● [mm]	N	☒	EAN
35D655	6x7, 8x9, 10x11, 12x13, 14x15, 16x17	x6	4/40	5902062044655
35D656	6x7, 8x9, 10x11, 12x13, 14x15, 16x17, 18x19, 20x22	x8	4/24	5902062044662
35D657	6x7, 8x9, 10x11, 12x13, 14x15, 16x17, 18x19, 20x22, 21x23, 24x27, 25x28, 30x32	x12	2/10	5902062044679

## Klucz oczkowy półotwarty

Flare nut wrench / Ringschlüssel halbopen / Ключ разрезной двухсторонний / Ключ торцевий нарізний двосторонній / Fékcsőkulcs / Cheie piuliță în formă de con / Očkový klíč polootevřený / Klíč otvorený očkový / Obročni ključ, odprti / Kilpinis raktas / Bremžu trubiņu atslēga / Vargamutri vōti / Ключ гаечен / Ključ ekscentrični / Кљус / Πολύγωνο κλειδί ημιάνοιχτο / Llave de estrella, abierta / Chiave doppia ad anello aperto / Chave de luneta semi aberta / Clef polygonale demi ouverte / Halfopen ringsleutel

NEO  
TOOLS

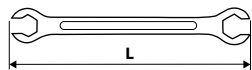

25  
years  
GUARANTEE

TUV  
Rheinland  
CERTIFIED

CrV  
steel



Ref.	● [mm]	L [mm]	☒	EAN
09-141	8x9	130	25/100	5907558404746
09-143	9x11	150	10/200	5907558404753
09-145	10x12	150	10/200	5907558404760
09-147	12x13	170	25/200	5907558404777
09-149	13x14	170	25/100	5907558404784
09-151	15x17	195	25/100	5907558404791

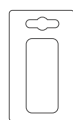

## TOPEX

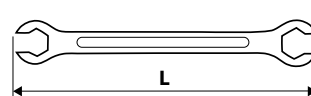

CrV



Ref.	● [mm]	L [mm]	☒	EAN
35D596	8x10	135	50/300	5902062355966
35D597	11x13	170	20/200	5902062355973

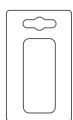

## Klucz oczkowy odgięty

Offset ring spanner / Ringschlüssel, gebogen / Ключ накидной изогнутый / Ключ накидний, вигнутий / Csillagkulcs enyhén hajlított / Cheie inelară-cotita / Klíč očkony vyhnutý / Očkový klúč ohnutý / Obročni upognjeni ključ / Kilpinis raktas, lenktas / Izliekta uzmanas atslēga / Kõvera otsaga silmusvõti / Глук заечен ключ отъгнат / Fleksibilni okasti ključ / Okasti ključ obrniti / Κλειδί πολύγωνο κυρτό / Llave de estrella acodada / Chiave poligonale doppia / Chave de luneta curvado / Clef polygonale contre-coudée / Gebogen ringsleutel

**NEO**  
TOOLS

25  
years  
GUARANTEE

TÜVRheinland  
CERTIFIED

CrV  
steel

DIN  
838

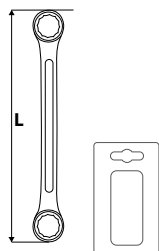

Ref.	● [mm]	L [mm]	☒	EAN
09-906	6x7	170	5/100	5907558411317
09-908	8x9	180	5/100	5907558411324
09-910	10x11	200	5/100	5907558411331
09-912	12x13	210	5/100	5907558411348
09-914	14x15	230	5/60	5907558411355
09-916	16x17	245	5/100	5907558411362
09-918	18x19	265	5/50	5907558411379
09-920	20x22	290	5/40	5907558411386
09-921	21x23	310	4/40	5907558411393
09-924	24x27	330	4/40	5907558411409
09-930	30x32	370	4/40	5907558411430

**NEO**  
TOOLS



25  
years  
GUARANTEE

TÜVRheinland  
CERTIFIED

CrV  
steel

x12

DIN  
838

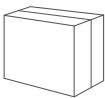

Ref.	● [mm]	☒	EAN
09-952	6x7, 8x9, 10x11, 12x13, 14x15, 16x17, 18x19, 20x22, 21x23, 24x27, 25x28, 30x32	0/6	5907558413137

**TOPEX**

CrV

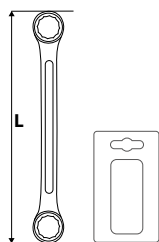

Ref.	● [mm]	L [mm]	☒	EAN
35D807	10x11	205	20/160	5902062044365
35D809	12x13	220	20/120	5902062044372
35D811	14x15	230	10/100	5902062044389
35D813	16x17	250	10/80	5902062044396
35D815	18x19	270	10/60	5902062044402
35D817	20x22	300	10/60	5902062044419
35D821	24x27	340	5/40	5902062044433
35D823	30x32	380	5/30	5902062044440

**TOPEX**

CrV



Ref.	● [mm]	N	☒	EAN
35D855	6x7, 8x9, 10x11, 12x13, 14x15, 16x17	x6	6/24	5902062044310
35D856	6x7, 8x9, 10x11, 12x13, 14x15, 16x17, 18x19, 20x22	x8	2/16	5902062044327

**TOP TOOLS**



Ref.	● [mm]	N	☒	EAN
35D455	6-17	x6	12/36	5902062040374

## Klucze oczkowe wygięte

Offset ring spanner / Ringschlüssel, gebogen / Ключ накидной изогнутый / Ключ накидний, вигнутий / Csillagkulcs készlet / Cheie inelară semi-luna / Očkový klíč zahnutý / Očkový klúč vyhnutý / Obročni ukrivljeni ključ / Kilpinis raktas, lenktas / Izliekta uzmanas atslēga / Poolkuiu-silmusvõti / Глук заечен ключ отъгнат / Okasti savinut ključ / Okasti izvijeni ključ / Κλειδί πολύγωνο κυρτό / Llave de estrella de media luna / Chiavi doppie poligonale a mezza luna / Chaves de luneta curvadas / Clefs polygonales coudées / Uitgebogen ringsleutels

**NEO**  
TOOLS

25  
years  
GUARANTEE

TÜVRheinland  
CERTIFIED

CrV  
steel

x5

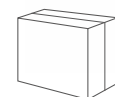

Ref.	● [mm]	☒	EAN
09-176	9x12, 13x15, 14x17, 16x18, 19x22	0/10	5907558404876





## Klucz oczkowy

Ring spanner / Ringschlüssel / Ключ накидной / Ключ накидний / Csillagkulcs / Cheie inelară / Očkový klíč / Očkový klúč / Obročni ključ / Kėlpinis raktas / Uzmaucama atslėga / Siltmusvõti / Глух гаечен ключ / Okasti ključ / Okasti ključ / Πολύγωνο κλειδί / Llave de estrella / Chave de luneta / Clef polygonale / Ringsleutel

NEO  
TOOLS



Ref.	● [mm]	L [mm]	📦	EAN
09-360	8 mm	235	10/100	5907558445145
09-361	10 mm	289	10/100	5907558445152
09-362	12 mm	325	10/100	5907558445169
09-363	13 mm	360	5/50	5907558445176
09-364	14 mm	363	5/50	5907558445183
09-365	16 mm	390	5/50	5907558445190
09-366	17 mm	403	5/50	5907558445206
09-367	19 mm	425	5/50	5907558445213
09-368	22 mm	450	5/25	5907558445220

NEO  
TOOLS

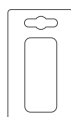

Ref.	● [mm]	📦	EAN
03-030	5 - 16	5/40	5907558445268
03-031	5 - 27	5/20	5907558445275

## Klucze oczkowe Torx

Offset ring spanner set / Ringschlüssel / Ключи накидные колеччатые / Ключи накидні / Csillagkulcs készlet torx / Set chei inelare de deviatie / Klíče očkové / Súprava očkových klíčov / Obročni ključ / Kėlpiniai raktai / Kombineto izliekto atslėgu kompleks / Mutrivõdmete komplekt / Ключ Лула компл. / Ključ okasti / Πολύγωνο κλειδιά / Llaves de estrella / Chiavi combinate Torx / Chaves de luneta / Clefs polygonales / Ringsleutels

NEO  
TOOLS

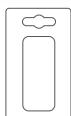

Ref.	★ [mm]	📦	EAN
09-980	T6xT8, T10xT12, T14xT18, T20xT24	20/60	5907558412239

## Klucze hakowe

Power grip pipe wrenches / Hackenschlüssel / Црюковые ключи / Ключи-закі / Univerzálnis kulcs / Chei seceră / Håkoné klíče / Håkoné klíče / Ključ s kavljem / Lenkti raktai / āķu atslėgas / Haakvõtmed / Ключове с хука / Kukasti ključevni / Kukasti ključ / Γαντζόκλειδα / Llaves de gancho / Giratubi / Chaves de anzol / Clefs à crochets / Haaksleutels

TOP TOOLS

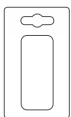

Ref.	● [mm]	📦	EAN
35D251	8-19	10/20	5902062043337

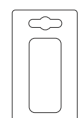

NEO  
TOOLS

CrV  
steel x6



Ref.	● [mm]	📦	EAN
09-370	8, 10, 13, 16, 17, 19		5907558483109

## Klucz płasko-nasadowy przegubowy

Open end and flex socket wrench / Gelenk-Steckschlüssel / Ключ шарнирный комбинированный / Ключ комбинований, різково-торцевий, шарнирний / Villáskulcs flex / Cheie fixă -tubulară cu articulație / Plochý a nástrčný klíč kloubový / Plochý-nástrčný klíč klbový / Ploščato-nasadni ključ z zglubom / Raktas su lankščia galvute antgaliams / Kombinēta šarnīra atslėga / Liigendiga lehtpadrunvõti / Комбиниран шарнирен ключ / Polosnato nastavni zglubni ključ / Pljosnati zglubni ključevni / Κλειδί γεραμοπολύγωνο αρθρωτό / Llave combinada (fija y de vaso) articulada / Chiave flessibile combinata a forchetta e a bussola / Chave plana articulada / Clef à fourche à douilles articulée / Geopend vlakke dopsleutel

TOP TOOLS

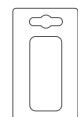

Ref.	● [mm]	📦	EAN
35D240	10	40/160	5902062042101
35D242	13	40/160	5902062041852

## Klucz do rusztowań

Double socket ratchet wrench / Der Schlüssel für das Gerüst / La clé pour échafaudages / Ключ для строительных лесов / Ключ для будівельних лисів / Cheia pentru schele / Chiave per impalcature / Klíč pro lešení / Klíč pre lešenie / Raktas

TOPEX

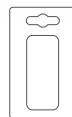

Ref.	Info	📦	EAN
38D300	19x22 mm	10/40	5902062035622



## Klucz trzpieniowy nasadowy

T-socket wrench / Vierkant-Aufsteckschlüssel / Ключ торцевой Т-образный / Ключ шестигранный торцевой накидной / T-kulcs / Cheie fixare forma T / Nástrčkový kľúč typu T / T kľúč / T kľuč, nasadni / T formos raktas / T-veida gala atslēga / T-padrūni mutrīvīti / T-образен ключ / T kľuč / T kľuč / Καταβίδακι καρυδάκι τύπου T / Llave de vaso con mango en T / Chiave a T / Chave tubular / Clef mâle à douilles articulée / Imbusdopsleutel

**NEO**  
TOOLS

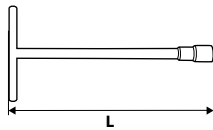

**TOPEX**

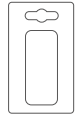
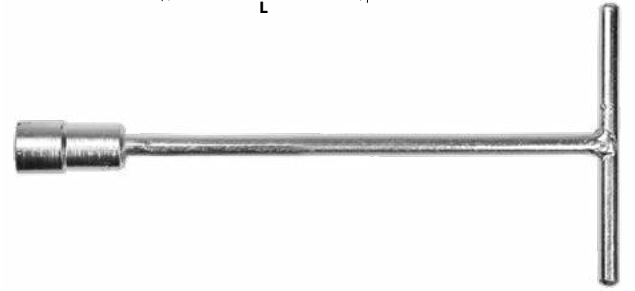
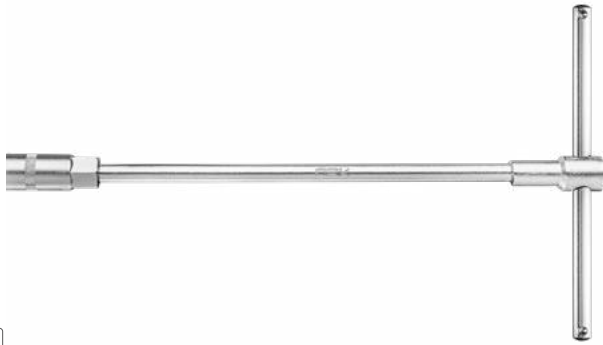

Ref.	● [mm]	L [mm]	☒	EAN
09-302	13	300	25/50	5907558414363

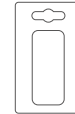

Ref.	● [mm]	L [mm]	☒	EAN
35D030	8	200	0/100	5902062201867
35D031	10	200	50/100	5902062201874
35D032	13	200	50/100	5902062201881
35D035	10	400	0/50	5902062201904
35D036	13	400	0/50	5902062201911

## Klucz fajkowy

L-type wrench / Pfeifenschlüssel / Рожковый ключ / Ключ торцовый кутовой / Pipakulcs / Cheie tubulară cotită / Zahnutý kľúč / Fajkový kľúč / Urognjien kľjuč / Pypkinis raktas / Radziņatslēga / Padrūnīvīti / Ключ лупа / Imbus kľjuč / Kosočeljusni zavrtjnani kľjuč / Γερμανικό κλειδί / Llave de pipa / Chiave a pipa / Chave de cabo curvo / Clef à pipe / Pijpsleutel

**NEO**  
TOOLS

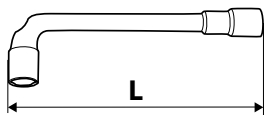

**TOPEX**

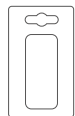
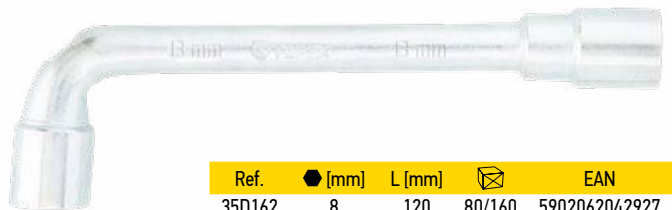
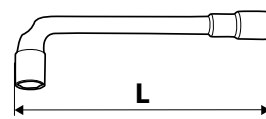

Ref.	● [mm]	L [mm]	☒	EAN
09-203	8	110	10/200	5907558405002
09-205	10	130	10/120	5907558405019
09-208	13	150	10/100	5907558405033
09-212	17	180	10/60	5907558405064
09-214	19	200	10/40	5907558405071

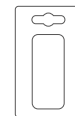

Ref.	● [mm]	L [mm]	☒	EAN
35D162	8	120	80/160	5902062042927
35D164	10	125	0/160	5902062042941
35D166	12	140	0/100	5902062042965
35D167	13	150	0/96	5902062042972
35D168	14	155	0/70	5902062042989
35D169	15	160	0/60	5902062042996
35D171	17	180	0/50	5902062043016
35D173	19	205	0/30	5902062043030
35D176	22	220	0/24	5902062043108
35D177	24	290	0/24	5902062043122
35D179	27	300	4/18	5902062043153

## Klucze rurowe

Tube spanners / Rohrschlüssel / Ключи торцовые трубчатые / Ключи трубни / Csőkulcs készlet / Chei tubulare / Trubkové kľúče / Růrkové kľúče / Kľučiči za cevi / Raktas vamzdžiams / Cauruļu atslēgas / Toruvõtmed / Τрубни ключове / Kľučevni za cijevi / Kľučevni za cevi / Σωληνωτά κλειδιά / Llaves de tubo / Chiavie a tubo / Chaves para Tubos / Clefs à tubes / Buissleutels

**TOPEX**



**TOP TOOLS**

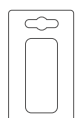

Ref.	● [mm]	L [mm]	☒	EAN
35D930	6x7	115	0/100	5902062359308
35D931	8x9	120	0/100	5902062359315
35D932	10x11	125	0/90	5902062359322
35D933	12x13	130	0/100	5902062359339
35D934	14x15	135	0/100	5902062359346
35D935	16x17	150	0/100	5902062359353
35D936	18x19	160	0/75	5902062359360
35D937	20x22	170	10/120	5902062359377
35D938	21x23	170	0/100	5902062359384
35D939	24x26	185	0/54	5902062359391
35D940	25x28	190	0/54	5902062359407
35D941	30x32	200	0/54	5902062359414

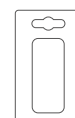

Ref.	● [mm]	N	☒	EAN
35D191	8-17	×6	0/60	5902062042163
35D193	6-22	×10	0/40	5902062040589



## Wykrętki do śrub

Screw extractor set / Schraubendreher / Экстракторы для винтов / Викручувачі зламаних гвинтів / Törtsavar kihajtó / Set înlăturare șuruburi / Vytahovák šroubů / Súprava vytahovačov zalomených skrutiek / Garnitura odvíjačev vijakov / Atsuktuvai varžtams / Skrūvis izvilcējs / Krúvieemalduskomplekt / Izvijac polomljenih vijaka / Συλλογή μηχανημάτων αφαίρεσης βιδών / Extractores de tornillos / Estrattori di viti / Saca-parafusos / Devisseuses pour vis / Schroevenlosdraaiers

**NEO**  
TOOLS



25 years  
GUARANTEE

TÜV Rheinland  
CERTIFIED

CrMo  
steel

x6

3/8"

Ref.	Ra[mm]	L[mm]	⊠	EAN
09-605	2-10	60	0/50	5907558410341

**NEO**  
TOOLS



25 years  
GUARANTEE

TÜV Rheinland  
CERTIFIED

CrMo  
steel

x15

1/2"



Ref.	Ra[mm]	Ra["]	⊠	EAN
09-607	3 - 14	1/8 - 1/2	0/20	5907558417241

**NEO**  
TOOLS



25 years  
GUARANTEE

TÜV Rheinland  
CERTIFIED

CrMo  
steel

x10



Ref.	Ra[mm]	⊠	EAN
09-609	2, 3, 4, 6.5, 7.5	0/60	5907558416503

**NEO**  
TOOLS



25 years  
GUARANTEE

TÜV Rheinland  
CERTIFIED

CrMo  
steel

x5

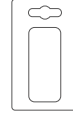

Ref.	Ra[M]	⊠	EAN
09-615	1/8" (M3-M6), 1/4" (M6-M8), 5/16" (M8-M11), 7/16" (M11-M14), 9/16" (M14-M18)	25/150	5907558416497

**TOPEX**



x5

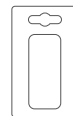

Ref.	Ø [mm]	⊠	EAN
14A110	3,3 - 19,0	10/100	5902062062048

**TOP TOOLS**



x5

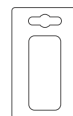

Ref.	Ø [mm]	⊠	EAN
14A105	3,3 - 19,0	10/60	5902062060495

## Komplet ściągaczy do szpilek

Roller stud extractor set / Abszieher-set / Набор ключей для снятия шпильки / Комплект викруток до шпильок / Csap/tűske csavaró szett / Set complet de extractoare pentru / Sada stahovadel na závrtné šrouby / Súprava valčekových stahovákov skrutiek / Komplet snemalcev zatičev / Nuëmëjü rinkinsj smeigëms / Novilcëju kompleks tapskrüvëm / Vardatõmmitsate komplekt / Комплект экстракторов за шпильку / Set skidača za nasadne ključeve / Komplet stega za igle / Set κλειδιά αφαίρεσης πειρών / Juego de extractores para agujas / Set estrattori / Kit de sacadores de pregos / Jeu d'extracteurs de goujon / Set van trekkers voor naalden

**NEO**  
TOOLS



25 years  
GUARANTEE

TÜV Rheinland  
CERTIFIED

CrV  
steel

x4

1/2"



Ref.	Ra[mm]	⊠	EAN
09-608	6, 8, 10, 12	0/24	5907558416534



## Wkrętak płaski

Screwdriver slotted / Flachschraubendreher / Отвертка плоская / Відкрітка плоска / Csavarhúzó lapos / Šurubelnjā platā / Šroubovák plochý / Skrutkovač plochý / Ploščati izvijač / Ploščias atsuktavas / Skrūvgriezis plakans / Lamepea-kruvikeeraja / Отвертка / Одвијач / Одвијач / Καταβίδι εγκοπής / Destornillador plano / Giravite piatto / Chave de fenda plana / Tournevis à fourche / Vlakke schroevendraaier

**NEO**  
TOOLS



Ref.	⌀ [mm]	L [mm]	📦	EAN
04-011	3,0	75	12/240	5907558401745
04-012	4,0	100	12/240	5907558401752
04-013	5,5	100	12/120	5907558401769
04-014	5,5	200	12/144	5907558401776
04-001	6,5	38	12/288	5907558411638
04-002	6,5	125	12/144	5907558411645
04-015	6,5	150	12/144	5907558401783
04-016	8,0	200	12/120	5907558401790
04-004	10,0	200	6/96	5907558411669

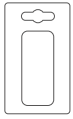
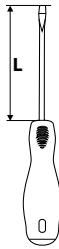

**NEO**  
TOOLS



Ref.	⌀ [mm]	L [mm]	📦	EAN
04-171	3,0	75	12/240	5907558440386
04-172	4,0	100	12/240	5907558440393
04-173	5,5	38	12/240	5907558440409
04-174	5,5	100	12/120	5907558440416
04-175	6,5	150	12/120	5907558440423
04-176	8,0	200	6/60	5907558440430

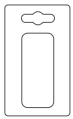
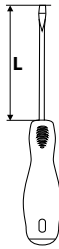

**T TOPEX**



Ref.	⌀ [mm]	L [mm]	📦	EAN
39D801	3,2	75	12/480	5902062398017
39D802	4,0	100	12/360	5902062398024
39D803	5,0	38	12/360	5902062398031
39D804	5,0	100	12/360	5902062398048
39D806	6,5	150	12/240	5902062398062

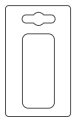
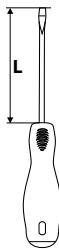

**TOP TOOLS**

**CrV**



Ref.	⌀ [mm]	L [mm]	📦	EAN
39D640	3,0	75	12/240	5902062396402
39D641	4,0	100	12/240	5902062396419
39D642	5,0	75	12/240	5902062396426
39D643	6,0	100	12/120	5902062396433
39D644	6,0	150	12/120	5902062396440
39D645	8,0	200	12/96	5902062396457

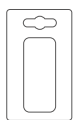
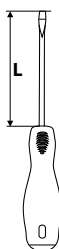

## Wkrętak płaski

Screwdriver slotted / Flachschraubendreher / Отвертка плоская / Відкрітка плоска / Csavarhúzó lapos / Šurubelnjā platā / Šroubovák plochý / Skrutkovač plochý / Ploščati izvijač / Ploščias atsuktavas / Skrūvgriezis plakans / Lamepea-kruvikeeraja / Отвертка / Одвијач / Одвијач / Καταβίδι εγκοπής / Destornillador plano / Giravite piatto / Chave de fenda plana / Tournevis à fourche / Vlakke schroevendraaier

**TOP TOOLS**



Ref.	⌀ [mm]	L [mm]	📦	EAN
39D011	4,0	100	12/240	5902062059635
39D012	5,0	75	12/240	5902062059642

## Wkrętak krzyżowy PH

Screwdriver Phillips / Kreuzschraubendreher / Отвертка крестовая / Відкрітка хрестовидна / Csavarhúzó philips / Šurubelnjā tip „Phillips” / Šroubovák křížový / Skrutkovač PH / Křížni izvijač / Kryžminis atsuktavas Phillips / Skrūvgriezis krusta PH / Ristpeakruvikeeraja / Отвертка / Одвијач / Одвијач / Καταβίδι σταυρωτό τύπου philips / Destornillador philips / Giravite Phillips / Chave de fenda de cruzeta / Tournevis en croix / Kriusschroevendraaier

**NEO**  
TOOLS



Ref.	+	L [mm]	📦	EAN
04-021	PH0	75	12/240	5907558401806
04-006	PH1	75	12/240	5907558411683
04-022	PH1	100	12/240	5907558401813
04-023	PH2	38	12/288	5907558401820
04-024	PH2	100	12/120	5907558401837
04-007	PH2	150	12/180	5907558411713
04-025	PH2	200	12/144	5907558401844
04-026	PH3	150	12/120	5907558401851

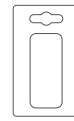
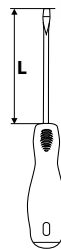

**NEO**  
TOOLS



Ref.	+	L [mm]	📦	EAN
04-177	PH0	75	12/240	5907558440447
04-178	PH1	100	12/120	5907558440454
04-179	PH2	38	12/240	5907558440461
04-180	PH2	100	12/120	5907558440478
04-181	PH3	150	6/60	5907558440485

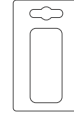
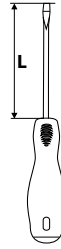

**T TOPEX**



Ref.	+	L [mm]	📦	EAN
39D820	PH0	75	12/480	5902062398208
39D821	PH1	100	12/360	5902062398215
39D822	PH2	38	12/360	5902062398222
39D823	PH2	100	12/240	5902062398239

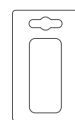
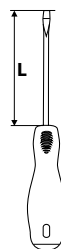

## Wkrętak krzyżowy PZ

Screwdriver Pozidriv / Kreuzschraubendreher / Отвертка крестовая / Відкрутка хрестовидна / Csavarhúzó pozidriv / Şurubelniştirip „Pozidriv” / Šroubovák křížový / Skrutkovač PZ / Křížni izvijač / Kryžminis atsuktuvus Phillips / Skrūvgriezis krusta PZ / Ristpeakruvikeeraja Pozidriv / Отвертка / Одвијач / Одвијач / Καταβίθι τύπου pozidriv / Destornillador phillips / Giravite Pozzi / Chave de fenda de cruzeta / Tournevis en croix / Kriusschroevendraaier

NEO TOOLS

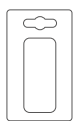
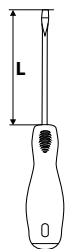

Ref.	+	L [mm]	☒	EAN
04-031	PZ0	75	12/600	5907558401868
04-032	PZ1	100	12/120	5907558401875
04-033	PZ2	38	12/288	5907558401882
04-034	PZ2	100	12/144	5907558401899
04-035	PZ2	200	12/144	5907558401905
04-036	PZ3	150	12/120	5907558401912

NEO TOOLS

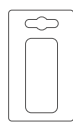
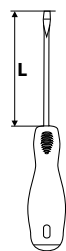

Ref.	+	L [mm]	☒	EAN
04-182	PZ0	100	12/240	5907558440492
04-183	PZ1	100	12/120	5907558440508
04-184	PZ2	100	12/120	5907558440515
04-185	PZ3	150	6/60	5907558440522

TOPEX

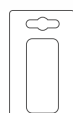
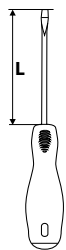

Ref.	+	L [mm]	☒	EAN
39D830	PZ1	100	12/360	5902062398307
39D831	PZ2	100	12/144	5902062398314

TOP TOOLS

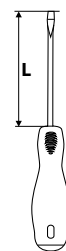

Ref.	+	L [mm]	☒	EAN
39D655	PZ1	75	12/240	5902062396556
39D656	PZ2	100	12/120	5902062396563

TOP TOOLS

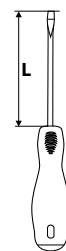

Ref.	+	L [mm]	☒	EAN
39D019	PZ1	75	12/240	5902062059710

## Wkrętak krzyżowy PH

Screwdriver Phillips / Kreuzschraubendreher / Отвертка крестовая / Відкрутка хрестовидна / Csavarhúzó phillips / Şurubelniştirip „Phillips” / Šroubovák křížový / Skrutkovač PH / Křížni izvijač / Kryžminis atsuktuvus Phillips / Skrūvgriezis krusta PH / Ristpeakruvikeeraja / Отвертка / Одвијач / Одвијач / Καταβίθι σταυρωτό τύπου phillips / Destornillador phillips / Giravite Phillips / Chave de fenda de cruzeta / Tournevis en croix / Kriusschroevendraaier

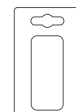
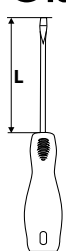

Ref.	+	L [mm]	☒	EAN
39D650	PH0	75	12/240	5902062396501
39D651	PH1	75	12/240	5902062396518
39D652	PH2	100	12/120	5902062396525

TOP TOOLS

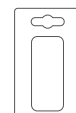
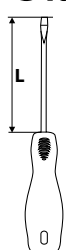

Ref.	+	L [mm]	☒	EAN
39D016	PH0	75	12/360	5902062059680
39D017	PH1	75	12/240	5902062059697
39D018	PH2	100	12/144	5902062059703

## Wkrętak Torx

Torx screwdriver / Schraubendreher Torx / Отвертка Torx / Вкрутка «Торх» / Csavarhúzó torx / Surubelniştirip varf Torx / Šroubovák Torx / Skrutkovač Torx / Izvijač Torx / Atsuktuvus, torcinis / Torx skrūvgriezis / Torx-kruvikeeraja / Отвертка Torx / Одвијач Torx / Καταβίθι Torx / Destornillador con punta torx / Giravite Torx / Chave de fenda Torx / Tournevis Torx / Torx schroevendraaier

NEO TOOLS

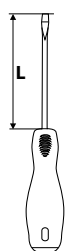

Ref.	+	L [mm]	☒	EAN
04-044	T15	100	12/240	5907558401936
04-045	T20	100	12/240	5907558401943
04-046	T25	100	12/144	5907558401950

NEO TOOLS

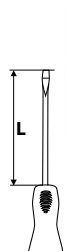

Ref.	+	L [mm]	☒	EAN
04-186	T10	100	12/120	5907558440539
04-187	T15	100	12/240	5907558440546
04-188	T20	100	12/240	5907558440553
04-189	T25	100	12/144	5907558440560
04-190	T27	100	12/144	5907558440577

TOPEX

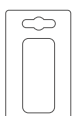
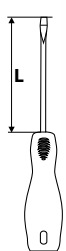

Ref.	+	L [mm]	☒	EAN
39D842	T10	100	12/240	5902062398420
39D843	T15	100	12/240	5902062398437
39D844	T20	100	12/240	5902062398444
39D845	T25	100	12/240	5902062398451



## Wkrętak płaski do pobijania

Slotted screwdriver go through / Schraubendreher, flach / Отвертка шлицевая ударная / Вікрутка плоска, ударна / Csavarhúzó üthető lapos / Surubelnitá impact varf drept / Šroubovák plochý úderový / Sekací plochý skrutkovač / Ploščati izvijač za zabijanje / Smūginis, plokščias atsuktuvas / Plakanais skrūvgriezis / Lame löökkruvikeeraja / Отвертка плоская ударная / Plosnati odvijač za nabijanje / Plosnati odvijač za zabijanje / Καταβίβι κρούσης ενίθετο / Destornillador plano de golpe / Giravite passante piatto / Chave de fenda plano p. malhar / Tournevis à fourche à frapper / Vlakke slagschroevendraaier

NEO TOOLS

25 years  
GUARANTEE

TÜVRheinland  
CERTIFIED

S2  
steel



TOPEX

CrV

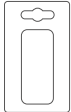
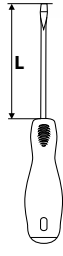
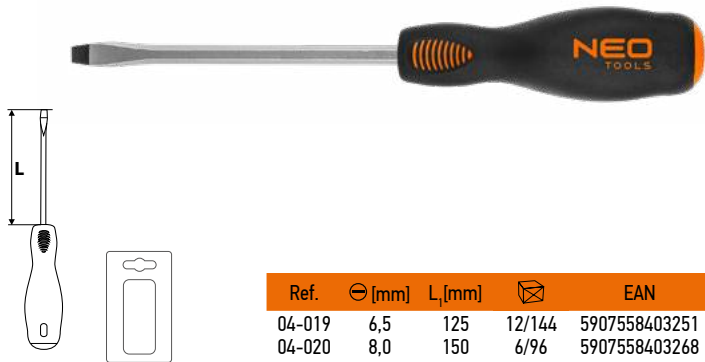

Ref.	⌀ [mm]	L <sub>h</sub> [mm]	⊠	EAN
04-019	6,5	125	12/144	5907558403251
04-020	8,0	150	6/96	5907558403268

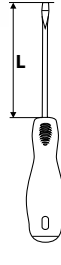
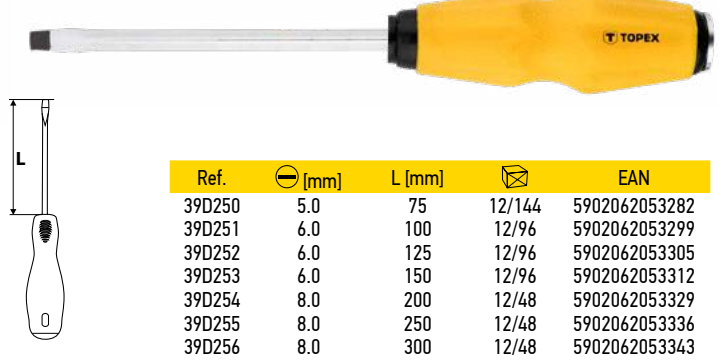

Ref.	⌀ [mm]	L [mm]	⊠	EAN
39D250	5,0	75	12/144	5902062053282
39D251	6,0	100	12/96	5902062053299
39D252	6,0	125	12/96	5902062053305
39D253	6,0	150	12/96	5902062053312
39D254	8,0	200	12/48	5902062053329
39D255	8,0	250	12/48	5902062053336
39D256	8,0	300	12/48	5902062053343

## Wkrętak krzyżowy do pobijania

Screwdriver go through phillips / Kreuzschraubendreher zum Klopfen / Отвертка крестовая усиленная ударная / Відкрутка хрестовидна ударна / Csavarhúzó üthető philips / Şurubelnitá cruciulită p/u spargere / Šroubovák křížový úderový / Skrutkovač úderový PHillips / Ploščati izvijač, udarni / Кръзминис, смūginis atsuktuvas / Skrūvgriezis krusta PH sitena / Ristpeakruvikeeraja / Отвертка / Одвijač / Одвijač / Σταυρωτό καταβίβι τύπου phillips / Destornillador de golpe phillips / Giravite passante Phillips / Chave de fenda de cruzeta p. malhar / Tournevis en croix à frapper / Slagkruisschroevendraaier

NEO TOOLS

25 years  
GUARANTEE

TÜVRheinland  
CERTIFIED

S2  
steel



TOPEX

CrV

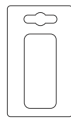
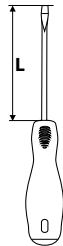

Ref.	⊕	L [mm]	⊠	EAN
04-028	PH2	100	12/144	5907558403282

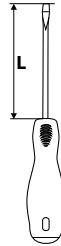
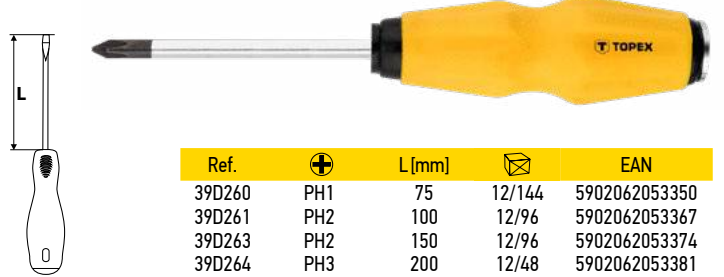

Ref.	⊕	L [mm]	⊠	EAN
39D260	PH1	75	12/144	5902062053350
39D261	PH2	100	12/96	5902062053367
39D263	PH2	150	12/96	5902062053374
39D264	PH3	200	12/48	5902062053381

## Wkrętaki do pobijania

Go through screwdrivers / Schraubendreher zum Aufheben / Отвертки ударные / Вікрутки ударні / Csavarhúzókészlet üthető / Surubelnita de impact / Šroubováky úderové / Sekacie skrutkovače / Izvijači za zabijanje / Smūginiai suktuvai / Triecienskrūvgrieži / Löökkruvikeerajad / Ударни отвертки / Одвijači za nabijanje / Одвijače za zabijanje / Καταβίβια κρούσης / Destornilladores de golpe / Set giraviti passante / Chaves de fenda p. malhar / Tournevis à frapper / Slagschroevendraaiers

NEO TOOLS

25 years  
GUARANTEE

TÜVRheinland  
CERTIFIED

S2  
steel



TOPEX

CrV



x6

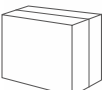

⊕ 5x100mm; 6.5x125mm; 8x150mm  
⊕ PH1x75; PH2x100

Ref.	⊠	EAN
04-240	12/24	5907558412857

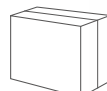

⊕ 5x75mm; 6x100mm; 6x125mm; 8x150mm  
⊕ PH1x75mm; PH2x100mm

Ref.	⊠	EAN
39D504	6/12	5902062395047



## Wkrętaki do pobijania

Go through screwdrivers / Schraubendreher zum Aufheben / Отвертки ударные / Викрутки ударні / Csavarhúzókészlet üthető / Surubelnita de impact / Šroubováky úderové / Sekacie skrutkovače / Izvijači za zabijanje / Smüginiai suktuvai / Triecienskrūvgrieži / Löökkruvikeerajad / Ударни отвертки / Dvijači za nabijanje / Dvijače za zabijanje / Καταβίδια κρούσης / Destornilladores de golpe / Set giraviti passante / Chaves de fenda p. malhar / Tournevis à frapper / Slagschroevendraaiers



**TOPEX**



- ⊖ 5x100mm; 5x150mm; 6x150mm
- ⊕ PH1x100mm; PH1x150mm; PH2x150mm

Ref. 39D506 | EAN 5902062395061

**TOP TOOLS**

**x6**



- ⊖ 5x75mm; 5x100mm; 6x150mm; 6x200mm
- ⊕ PH2x75mm; PH2x100mm

Ref. 39D104 | EAN 5902062050298

## Wkrętaki

Screwdriver set / Schraubendreher / Отвертки / Викрутки, набір / Csavarhúzókészlet / Set surubelnite / Šroubováky / Súprava skrutkovačov / Garnitura izvijačev / Atsuktuvai / Skrūvgriežu komplekts / Kruvikeerajate komplekt / Отвертки компл. / Dvijači / Dvijač set / Συλλογή από καταβίδια / Destornilladores / Set giraviti / Chaves de fenda / Tournevis / Schroevendraaiers

**NEO TOOLS**



- ⊖ 6x125 mm; 5x100 mm; 3x75 mm
- ⊕ PH2x125 mm; PH1x100 mm; PH0x75 mm

Ref. 04-213 | EAN 5907558432220

**NEO TOOLS**



- ⊖ 8x150; 6.5x125; 5.5x100; 6.5x38 mm
- ⊕ PH2x125; PH1x100; PH0x75; H2x38 mm

Ref. 04-207 | EAN 5907558422177

**NEO TOOLS**



- ⊖ 5.5x75 mm, 6.5x100 mm
- ⊕ PH1x75 mm, PH2x100 mm

Ref. 04-204 | EAN 5907558402254

**NEO TOOLS**



- ⊖ 6.5x150; 6.5x125; 5.5x100; 3x75 mm
- ⊕ PH2x125; PH1x100; PH0x75 mm

Ref. 04-206 | EAN 5907558422214



## Wkręćaki

Screwdriver set / Schraubendreher / Отвертки / Відкрутки, набір / Csavarhúzókészlet / Set şurubelnițe / Šroubováky / Súprava skrutkovačov / Garnitura izvijačev / Atsuktuvai / Skrūvgriežu komplekts / Kruvikeerajate komplekt / Отвертки компл. / Odvijaci / Odvijac set / Συλλογή από καταβίδια / Destornilladores / Set giraviti / Chaves de fenda / Tournevis / Schroevendraaiers

**NEO**  
TOOLS

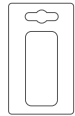

⊖ 4x250mm, 5.5x250mm  
⊕ PH1x250mm, PH2x250mm

Ref. 04-214    6/24    EAN 5907558435627

**NEO**  
TOOLS



⊖ 6.5x150mm; 5.5x100mm; 3x75mm; 5.5x38mm; 6.5x38mm  
⊕ PH2x150mm; PH1x100mm; PH0x75mm; PH2x38mm

Ref. 04-208    6/12    EAN 5907558422221

**NEO**  
TOOLS



⊖ 5x250 mm, 4x250 mm  
⊕ PH2x250 mm, PH1x250 mm

Ref. 04-191    6/24    EAN 5907558442656

**NEO**  
TOOLS



⊖ 3.0x75mm, 5.5x100mm, 6.5x150mm  
⊕ PH1x100mm, PH2x150mm

Ref. 04-192    6/24    EAN 5907558442663

**NEO**  
TOOLS



⊖ 5.5x38mm, 5.5x100mm, 6.5x150mm  
⊕ PH1x100mm, PH2x38mm, PH2x150mm

Ref. 04-193    6/24    EAN 5907558442670

**NEO**  
TOOLS



⊖ 2x50mm; 2.4x50mm; 6.5x38mm; 6.5x100mm  
⊕ PH0x50mm; PH1x50mm; PH2x100mm; PH2x38mm

Ref. 04-194    6/24    EAN 5907558442687





## Wkręćaki

Screwdriver set / Schraubendreher / Отвертки / Відрізки, набір / Csavarhúzókészlet / Set surubelniče / Šraubováky / Súprava skrutkovačov / Garnitura izvijačev / Atsuktuvai / Skrivgriežu komplekts / Krivkeerajate komplekt / Отвертки компл. / Odvijaci / Odvijac set / Συλλογή από καταβίδια / Destornilladores / Set giraviti / Chaves de fenda / Tournevis / Schroevendraaiers

### T TOPEX



CrV

x6

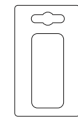

⊖ 5x38mm; 5x100mm, 6.5x150mm  
⊕ PH1x100mm; PH2x38mm; PH2x150mm

Ref. 39D886  
EAN 5902062398864

### T TOPEX

CrV

x9



⊖ 8x200mm; 6.5x100mm; 3.2x100mm  
⊕ PH2x150mm; PH1x100mm; PH0x100mm  
⊕ PZ2x150mm; PZ1x100mm; PZ0x100mm

Ref. 39D930  
EAN 5902062013897

### T TOPEX

CrV

x4

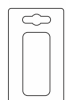

⊖ 3.2x100mm; 6.5x125mm  
⊕ PH1x75mm; PH2x100mm

Ref. 39D933  
EAN 5902062013927

### TOP TOOLS



x2

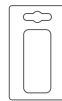

⊖ 6x38mm  
⊕ PH1x38mm



Ref. 39D174  
EAN 5902062002716

### TOP TOOLS

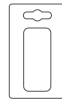

⊖ 6x100mm  
⊕ PH2x100mm



x2

Ref. 39D179  
EAN 5902062052995

### TOP TOOLS



⊖ 4x100mm; 5x125mm; 6x150mm  
⊕ PH1x100mm; PH2x125mm



x5

CrV

Ref. 39D503  
EAN 5902062395030

### TOP TOOLS

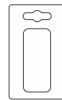

⊖ 4x75mm; 5x100mm; 5x150mm  
⊕ PH1x100mm; PH2x150mm



x5

Ref. 39D105  
EAN 5902062050328

### TOP TOOLS



⊖ 4x75mm; 5x100mm; 5x150mm  
⊕ PH0x75mm; PH1x100mm; PH1x150mm



x6

Ref. 39D106  
EAN 5902062050304



## Wkrętak odwracalny

Reversible screwdriver / Schraubendreher, umwendbar / Отвертка универсальная / Викрутка універсальна, з двобічними знімними наконечниками / Csavarhúzókészlet / Surubelniță cu varf dublu, reversibil / Šroubovák oboustranný / Otáčací skrutkovač / Dvosmerni izvijač / Atsuktuvas su keičiamais antgaliais / Universālais skrūvgrēzis / Pööratava peaga kruvikeeraja / Універсальна отвертка / Povratni odvijač / Povratni odvijač / Καταβίβι γενικής χρήσης / Destornillador reversible / Giravite reversibile / Chave de fenda reversível / Tournevis réversible / Omkeerbare schroevendraaier

**NEO**  
TOOLS



**TOPEX**

**CrV x4**



⊖ 6x38 mm  
⊕ PH2x38 mm



Ref. 04-201 12/144 5907558402230

**TOP TOOLS**



⊖ 5.5x90 mm  
⊕ PH2x90 mm

Ref. 39D177 20/200 590206250810

## Wkrętaki i końcówki wkrętakowe

Screwdrivers and bits / Schraubendreher und Einsätze für Schraubendreher / Отвертки и насадки / Викрутки і наконечники викруток / Csavarhúzó és bitkészlet / Set surubelniță și capete / Šroubováky a šroubovákové nástavce / Skrutkovače a skrutkovacie nástavce / Izvijači in nastavki za izvijače / suktuvai ir antgaliai / Skrūvgrēži un to uzgali / Kruvikeerajad ja kruvikeerajatsakud / Отвертки и наконечники за тях / Odvijači i nastavci za odvijače / Odvijači i nastavci za odvijače / Καταβίβια και καταβιδώματα / Destornilladores y puntas / Set giraviti e inserti / Chaves de fenda e ponteiros de chave de fenda / Tournevis et embouts de tournevis / Schroevendraaiers en schroevendraaiereindstukken

**NEO**  
TOOLS



⊖ 8x150; 6.5x125; 5.5x100; 3x75; 2.5x50; 3.0x50 mm  
⊕ PH2x125; PH1x75; PH0x50; PH0x50 mm  
⊕ T6x50; T7x50; T8x50 mm

4; 5; 6 mm; PH1; PH2; PH3; PZ1; PZ2; PZ3; T10; T15; T20; T25; H4; H5; H6

Ref. 04-209 5/10 5907558422207

**NEO**  
TOOLS



⊖ 6.5x125; 5.5x100; 6.5x38; 2.5x50; 2.0x50 mm  
⊕ PH2x125; PH2x100; PH1x75; PH2x38; PH0x50; PH0x50 mm  
⊕ T5x50; T6x50; T7x50; T8x50; T9x50; T10x50 mm

3; 3; 4; 4; 5; 5; 6, 6 mm; PH0; PH0; PH1; PH1; PH2; PH2; PH3; PH3; T10; T10; T15; T20; T20; T25; T25; T27; T27; T30; T30; H2; H2; H2.5; H2.5; H3; H3; H4; H4; H5; H5; H6; H6

Ref. 04-211 6/12 5907558422191

**NEO**  
TOOLS



⊖ 8x150; 6.5x100; 5.5x75; 6.5x38; 2.5x40; 3.0x40 mm  
⊕ PH3x150; PH2x100; PH1x75; PH2x38; PH0x40; PH0x40 mm  
⊕ T5x40; T6x40; T7x40; T8x40 mm

4; 5; 6 mm, PH1; PH2; PH3; PZ0; PZ1; PZ2; PZ3, T10; T15; T20; T25; T30; T40; H3; H4; H5; H6

Ref. 04-210 5/10 5907558422160

**NEO**  
TOOLS



⊖ 3x75mm, 4x100 mm, 5.5x100mm, 6.5x150mm  
⊕ PH1x100mm, PH2x150mm

4.5; 6; 7 mm; PH0, PH1, PH2, PH3; T10, T15, T20, T25, T27, T30, T40; H2, H3, H4, H5, H6

Ref. 04-197 6/12 5907558442700

## Wkrętaki i końcówki wkrętakowe

Screwdrivers and bits / Schraubendreher und Einsätze für Schraubendreher / Отвертки и насадки / Вкрутки и наконечники вкруток / Csavarhúzó és bitkészlet / Set surubelnița și capete / Šroubováky a šroubovákové nástavce / Skrutkovače a skrutkovačie nástavce / Izvijači in nastavki za izvijače / sukutvai ir antgaliai / Skřůvgrieži un to uzgaļi / Kruvikeerajad ja kruvikeerajaotsakud / Отвертки и наконечники за тях / Odvijači i nastavci za odvijače / Odvijači i nastavci za odvijače / Катавѣрѣа και катавѣρѣομλετς / Destornilladores y puntas / Set giravite e inserti / Chaves de fenda e ponteiros de chave de fenda / Tournevis et embouts de tournevis / Schroevendraaiers en schroevendraaierinstukken

NEO TOOLS



6.5x100mm  
PH2x100mm, PH1x75mm

4, 5, 6 mm; T10, T15, T20, T25, T27, T30, T40

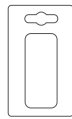

Ref.	⊠	EAN
04-196	6/24	5907558442694

## Wkrętak precyzyjny płaski

Slotted precision screwdriver / Feinschraubendreher, flach / Отвертка прецизионная шлицевая / Вкрутка прецизиона, плоска / Műszerész csavarhúzó / Surubelnița de precizie, varf drept / Šroubovák precizní ploché / Precizny plochý skrutkovač / Precizni ploščati izvijač / Atsuktuvus plokščias, torcinis / Precizjošais plakanais skrūvgriežis / Lame reenkruvikeeraja / Отвертка плоска прецизна / Precizni plosnati odvijač / Precizni pļosnati odvijač / Катавѣρѣа ακριβείας επίπεδο / Destornillador plano de precisión / Giravite di precisione piatto / Chave de fenda precisa plano / Tournevis de précision à fourche / Vlakke fijnschroevendraaier

NEO TOOLS

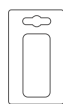

Ref.	⊖ [mm]	L [mm]	⊠	EAN
04-112	2,0	50	12/240	5907558435511
04-113	2,5	50	12/240	5907558435528
04-114	3,0	50	12/240	5907558435535

## TOPEX

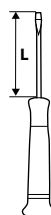

Ref.	⊖ [mm]	L [mm]	⊠	EAN
39D771	2.5	50	75/300	5902062397713
39D772	3	50	75/300	5902062397720

## Wkrętak precyzyjny krzyżowy PH

Cross slotted precision screwdriver / Feinschraubendreher, Kreuz / Отвертка прецизионная крестовидная / Вкрутка прецизиона, крестовидна / Műszerész csavarhúzó / Surubelnița de precizie, varf cruce / Šroubovák precizní křížový / Precizny křížový skrutkovač / Křížni precizní izvijač / Atsuktuvus precizinis, kryžminis / Precizjošais krustveida skrūvgriežis / Lame ristpeakruvikeeraja / Отвертка прецизна кръстата / Precizni křížni odvijač / Precizni kukasti odvijač / Σταυροκαταβίδο ακριβείας / Destornillador de precisión phillips / Giravite di precisione Phillips / Chave de fenda precisa de cruzeta / Tournevis de précision en croix / Fijnskruwschroevendraaier

NEO TOOLS



Ref.	⊕	L [mm]	⊠	EAN
04-115	2,0	50	12/240	5907558435511
04-116	2,5	50	12/240	5907558435528
04-117	3,0	50	12/240	5907558435535

## TOPEX

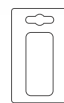

Ref.	⊕	L [mm]	⊠	EAN
39D773	PH0	50	75/300	5902062397737
39D774	PH00	50	75/300	5902062397744

## Wkrętak precyzyjny Torx

Precision Torx screwdriver / Feinschraubendreher, Torx / Отвертка прецизионная torx / Вкрутка прецизиона «torx» / Műszerész torx csavarhúzó / Surubelnița de precizie, varf torx / Šroubovák precizní Torx / Precizny skrutkovač Torx / Precizni izvijač Torx / Atsuktuvus precizinis, torcinis / Precizjošais torx skrūvgriežis / Lame Torx-kruvikeeraja / Прецизна отвертка torx / Precizni odvijač torx / Precizni torx odvijač / Σταυροκαταβίδο ακριβείας torx / Destornillador de precisión torx / Cacciavite di precisione torx / Chave de fenda precisa torx / Tournevis de précision Torx / Telescopische schroevendraaier

## TOPEX



Ref.	⊕	L [mm]	⊠	EAN
39D775	T5	50	75/300	5902062397751
39D776	T6	50	75/300	5902062397768
39D778	T8	50	75/300	5902062397782

## Wkrętaki precyzyjne

Precision screwdriver set / Präzisionsschraubendreher / Отвертки прецизионные / Відкрутки прецизиїні, набір / Műszerész csavarhúzókészlet / Set surubelnița / Šroubováky jemná mech. / Súprava mikroskrutkovačov / Garnitura natančnih izvijačev / Atsuktuvai tikslieš darbam / Skřůvgrieži komplekts / Täppiskruvikeerajate komplekt / Отвертки компл. / Odvijač / Odvijac set / Συλλογή καταβιδιών ακριβείας / Destornilladores de precisión / Set giravite di precisione / Chaves de fenda precisas / Tournevis de précision / Fijnschroevendraaiers

NEO TOOLS



1.5x40 mm, 2.0x40 mm, 2.5x40 mm  
PH00x40 mm, PH0x40 mm

Ref.	⊠	EAN
04-225	6/24	5907558402285



## Wkrętaki precyzyjne

Precision screwdriver set / Präzisionsschraubendreher / Отвертки прецизионные / Відкрутки прецизійні, набір / Műszerész csavarhúzókészlet / Set şurubelnițe / Šroubováky jemná mech. / Súprava mikroskrutkovačov / Garnitura natančnih izvijačev / Atskutuvai tiksliems darbams / Skrūvgriežu komplekts / Tāppiskruvīķerājate komplekts / Отвертки компл. / Odvijac / Odvijac set / Συλλογή κατασβιδιών ακριβείας / Destornilladores de precisión / Set giraviti di precisione / Chaves de fenda precisas / Tournevis de précision / Fijnschroevendraaiers

**T TOPEX**

**CrV x7**



- ⊖ x ⊕ 1.5 mm x T5; 2 mm x T6; 3 mm x T7
- ⊕ x ⊕ PH000 x T8; PH00 x T9; PH0 x T10

Ref. 39D551    12/72    EAN 5902062053237

**T TOPEX**

**CrV x7**



- ⊖ 2.0 x 50 mm; 2.5 x 50 mm; 3.0 x 50 mm
- ⊕ PH00 x 50 mm; PH0 x 50 mm
- ⊕ T8 x 50 mm; T10 x 50 mm

Ref. 39D552    10/80    EAN 5902062053220

**T TOPEX**

**CrV x7**



- ⊖ 1.5 x 50 mm; 2.0 x 50 mm; 2.5 x 50 mm
- ⊕ PH00 x 50 mm; PH0 x 50 mm
- ⊕ T5 x 50 mm; T6 x 50 mm

Ref. 39D558    10/50    EAN 5902062395580

**T TOPEX**

**CrV x6**



- ⊖ 1.4 mm; 2.0 mm; 2.4 mm
- ⊕ PH00; PH0; PH1

Ref. 39D559    10/60    EAN 5902062395597

**TOP TOOLS**

**x6**



- ⊖ 1, 1.2, 1.8, 2.4 mm
- ⊕ PH0, PH1

Ref. 39D193    20/200    EAN 5902062050380

**TOP TOOLS**

**x11**



- ⊖ 0.9x23mm, 1.2x23mm, 1.4x24mm, 1.8x24mm, 2.4x25mm, 3.0x29mm
- ⊕ PH00x23mm, PH0x26mm, PH1x27mm, AWL x 27 mm
- ⊖ AWL x 27 mm

Ref. 39D194    0/100    EAN 5902062053084



## Końcówki wkrętakowe precyzyjne z uchwytem

Precision screwdriver bits with holder / Einsätze für Schraubendreher, fein mit Aufnahme / Набор насадок прецизионных с держателем / Насадки викруткові, прецизійні, з рукоятям / Preciزیós csavarhúzóbetétek tartóval / Set maner si biti, precizie / Šroubovákové nástavce precizní s držadlem / Skrutkovacie nástavce precízne s upínadlom / Nastavki za precizni izvijač z vpenjalom / Atsuktuvo antgaliai, preciziniai su laikikliu / Precižėješu uzgaļu komplekts ar turētāju / Peenkrivikeeraajatsakud koos käepidemega / Комплект прецизни накрайниці за отвертка с держач / Precizni nastavi cza odvijač s hvataljkom / Nastavci za precizni odvijač s drškom / Set me kataavtóbómutes akribéias kai proasariouéa / Puntas destornilladoras de precisión con mango / Inserti di precisione per avvitare con impugnatura / Ponteiros chave de fenda precisos com suporte / Embouts de tournevis de précision avec manche / Fijnschroevendraaiereindstukken met handvat

NEO  
TOOLS

CrV steel UNIVERSAL set x73

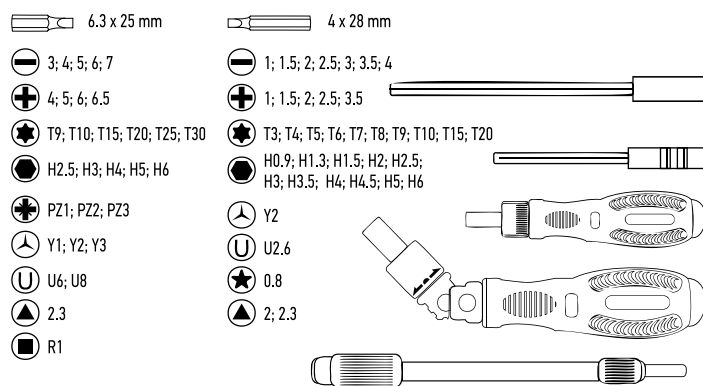

Ref. 06-115 EAN 5907558431896

NEO  
TOOLS

CrV steel UNIVERSAL set x69

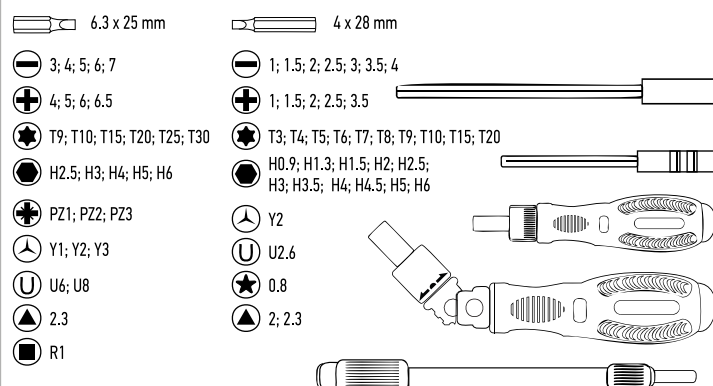

Ref. 06-116 EAN 5907558431902

NEO  
TOOLS

CrV steel PRECISION set x53

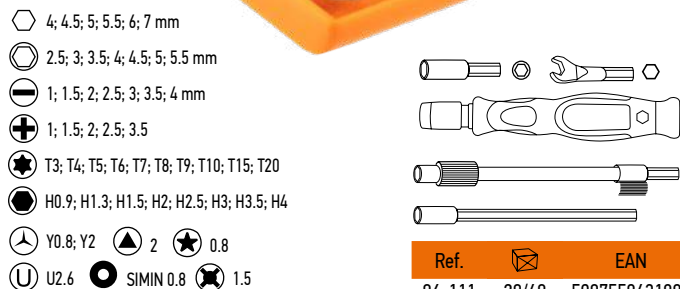

Ref. 06-111 EAN 5907558431889

NEO  
TOOLS

25 years GUARANTEE TÜV Rheinland CERTIFIED CrMo steel x17 5/32" 30mm x16



Ref. 04-228 EAN 5907558410068



## Końcówki wkrętakowe precyzyjne z uchwytem

Precision screwdriver bits with holder / Einsätze für Schraubendreher, fein mit Aufnahme / Набор насадок прецизионных с держателем / Насадки викруткові, прецизійні, з рукоятям / Precizios csavarhúzóbetétek tartóval / Set maner si biti, precizie / Šroubovácové nástavce precizní s držadlem / Skrutkovacie nástavce precízne s upínadlom / Nastavki za precizni izvijač z vpenjalom / Atsuktuvo antgaliai, preciziniai su laikikliu / Precizijoje su uzgaliu komplekts ar turētāju / Peenkrivikeeraajatsakud koos käepidemega / Комплект прецизних накруйниці за отвёртка с держач / Precizni nastavi cza odvijač s hvataljkom / Nastavci za precizni odvijač s drškom / Σετ με καταβιδώµετε ακριβείας και προσαρµογέα / Puntas destornilladoras de precisión con mango / Inserti di precisione per avvitare con impugnatura / Ponteiros chave de fenda precisos com suporte / Embouts de tournevis de précision avec manche / Fijnschroevendraaierendstukken met handvat

**TOPEX**



100 mm

- 1, 1.5, 2.0, 2.5, 3.0, 3.5 mm
- PH000, PH00, PH0, PH1
- P20, P21
- T4, T5, T6, T7, T8, T9, T10, T15, T20
- H0.7, H0.9, H1.3, H2, H2.5, H3, H4
- 2.5, 3, 3.5, 4, 4.5, 5, 5.5 mm

Ref. 39D343 | EAN 5902062034182

**TOPEX**

**CrV**  
**x32**



- 1; 1.5; 2; 2.5; 3; 3.5; 4 mm
- PH000; PH00; PH0; PH1
- P20; P21
- T4; T5; T6; T7; T8; T9; T10; T15; T20
- H0.7; H0.9; H1.3; H1.5; H2; H2.5; H3; H4

Ref. 39D555 | EAN 5902062053275

**TOP TOOLS**

**25**  
**MM**



- SL 2.0mm, SL 2.5mm
- PH000, PH00
- Star 0.8mm, star 1.2mm

Ref. 39D197 | EAN 5902062035738

## Wkrętak z giętkim grotem

Screwdriver with flexible shank with bits / Schraubendreher mit flex. Spitze / Отвёртка с гибким стержнем / Відкрутка з жгалом на шарнірі / Csavarhúzó készlet flexibilis nyéllel / Şurubeliği çorp flexibel çav vıř / Šroubovák s pružným hrotem / Skrutkovač Flexi+Bity / Izvijač s pregibno konico / Atsuktuvas su lanksčia šerdimi / Skrūvgriežis ar lokano galu uzgajlem / Painduva käepidemega kruvikeeraja / Отвёртка с Накруйниці / Одвijaс / Καταβιδί με εύκαμπτη λαβή και σετ µυτών / Destornillador con vástago flexible + puntas / Cacciavite con la punta flessibile / Chave de fenda com ponta flexível / Tournevis à pointe douce / Schroevendraaier met zachte eindstuk

**NEO TOOLS**



- 5, 6, 7 mm
- PH1, PH2, PH3, PZ1, PZ2
- T15, T20

Ref. 04-212 | EAN 5907558402261

**TOPEX**

**CrV**  
**x12**  
**1/4"**

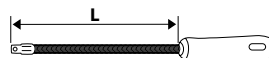

1/4" - 1/4"



- 4; 5; 6; 7 mm
- PZ1; PZ2; PZ3
- T10; T15; T20; T30

Ref. 39D865 | EAN 5902062398659

**TOP TOOLS**

**x12**



Ref. 39D122 | EAN 5902062053268

## Zestaw do serwisowania smartfonów

Smartphone repair kit / Smartphone-Service-Set / Набор для ремонта смартфонов / Набор для ремонту смартфонів / Okostelefon javító készlet / Set de servisarea smartphoane-uri / Servisní sada pro smarthony / Súprava na opravu smartfónov / Komplet za servisiranje pametnih telefonov / Rinkinys smartfonų remontui / Smartfonu arkapes komplekts / Nutitelefonide hoolduskomplekt / Комплект за підтримку на смартфонів / Set za servisiranje smartfona / Komplet za servisiranje pametnih telefona / Σετ επισκευής κινητών smartphone / Juego para reparación de smartphones / Completo per manutenzione smartphone / Jogo de ferramentas para smartphones / Kit de maintenance pour smartphone

**NEO TOOLS**

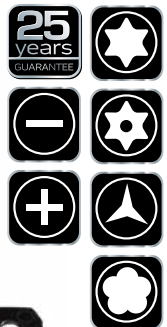

- SL 1.2 mm
- PH000, PH00
- T4, T5, T6, T8, T10
- 0,8

Ref. 06-108 | EAN 5907558403430

## Uniwersalny uchwyt do smartfonów

Universal phone holder / Universeller Smartphone-Halter / Универсальный держатель для смартфонов / Универсальный тримач для смартфонів / Univerzální okostelefon szerelő állvány / Suport universal pentru smartphone / Univerzálny držák na smartfóny / Univerzální držák pro smartphony / Univerzalno držalo za pametne telefone / Univeršalus išmaniojo telefono laikiklis / Univeršals viedtālruna turētājs / Univeršaalne nutitelefoni hoidja / Универсален държач за смартфон / Univerzalni držača za pametni telefon / Универзални држач за паметни телефон / Каβολник θήκη smartphone / Soporte universal para smartphone / Supporto universale per smartphone / Suporte universal para smartphone / Support universel pour smartphone / Universele smartphonehouder

NEO  
TOOLS

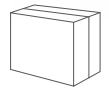

SL 2 x 50mm  
PENTALOBE  
0.8 x 50mm

Ref. 06-123  
EAN 5907558444759

## Szko powiększające

Magnifying glass / Lupe / Увеличительное стекло / Збільшувальне скло / Nagyító / Vergrößerungsglas / Lupä / Zväčšujúce sklo / Povečevalno steklo / Didinamasis stiklas / Palielinošais stikls / Suurendusklaas / Лупа / Povečalo / Lupa / Μεγεθυντικός φακός / Lupa / Lente d'ingrandimento / Lente de aumento / Loupe / Vergrotingsglas /

NEO  
TOOLS

3xLED light  
DPT 2.5x 110 mm  
DPT 4x 20 mm  
DPT 25x 20 mm  
X3 AAA

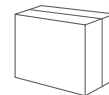

Ref. 06-129  
EAN 5907558444810

## TOPEX



3  
dpt

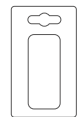

Ref. 79R290  
ø [mm] 90  
EAN 5902062023865

## Soczewki powiększające

Magnifying lenses / Vergrößerungslinsen / Увеличительные линзы / Линзи збільшувальні / Nagyító lencsék / Lentile de mărire / Zvětšovací čočky / Zväčšujúce sošovky / Povečevalne leče / Didinamiēji lēšiai / Palielinošās lēcas / Suurendusklaasid / Увеличителни леци / Povečale leče / Повећала сочива / Μεγεθυντικοί φακοί / Lentes de aumento / Lenti d'ingrandimento / Lentes de aumento / Lentilles grossissantes / Vergrotende lenzen

NEO  
TOOLS



2xLED light

DPT 1.0x, 1.5x, 2.0x, 2.5x, 3.5x

x2 AAA

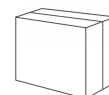

Ref. 06-130  
EAN 5907558444827

## Szczypce do ekranów

Screen opening tool / Bildschirmzange / Щипцы для экрана / Щипци для екрана / Kijelző Fogó / Clești pentru ecrane / Kliešte na obrazovky / Kliešte na obrazovky / Kliešče za zaslon / Ekranu replės / Ekrāna knaibles / Ekraanitangid / Экранни клеци / Klijesta za sito / Кљуешта за сито / Πένες οθόνης / Alicates de pantalla / Pinza a ventosa per schermi / Alicates de tela / Pince à écran / Schermtang /

NEO  
TOOLS

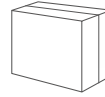

Ref. 06-122  
EAN 5907558444742

## Zestaw otwieraków

Opener set / Öffner-Satz / Открывалки набор / Набор інструменту для розкладання / Szétválasztó készlet / Set deschizătoare / Súprava otváračov / Sada otváracích nástrojů / Set odpiral / Atidarymo komplektas / Atvėreju komplekts / Avaja komplekt / Комплект отварачки / Set otvarača / Отварач сеп / Σετ ανοιχτήρι / Juego de abridor / Leve di separazione / Conjunto abridor / Jeu d'ouvreurs / Opener set

NEO  
TOOLS



ANTI  
STATIC

x13



Ref. 06-127  
EAN 5907558444797

## Wkrętek teleskopowy z końcówkami

Telescopic screwdriver with bits / Teleskop-Schraubendreher mit Einsätzen / Отвертка с длинным стержнем с насадками / Викрутка телескопічна з наконечниками / Teleszkópos csavarhúzókészlet / Surubelhiță telesopică cu capete / Teleskopický šroubovák s nástavci / Teleskopický skrutkovač s nástavcami / Teleskopski izvijač z nastavki / Teleskopinis suktuvas su antgaliais / Skrūvgriezis Teleskopisks skrūvgriezis ar uzgājiem / Teleskoopkruikeeraja koos otsakutega / Телескопична отвертка с наконечнику / Teleskopski odvijač s nastavcima / Teleskopski odvijač s nastavcima / Τηλεσκοπικό καταβίδι με μύτες / Destornillador telescópico con puntas / Giravite telescopic con inserti / Chave de fenda telescópico com ponteiros / Tournevis télescopique avec embouts / Telescopische schroevendraaier met eindstukken

TOP TOOLS

x20

- 4, 5, 6 mm
- PH1, PH2, PH3
- T10, T15, T20, T25, T30,
- H4, H6
- 4, 5, 6, 7, 8 mm

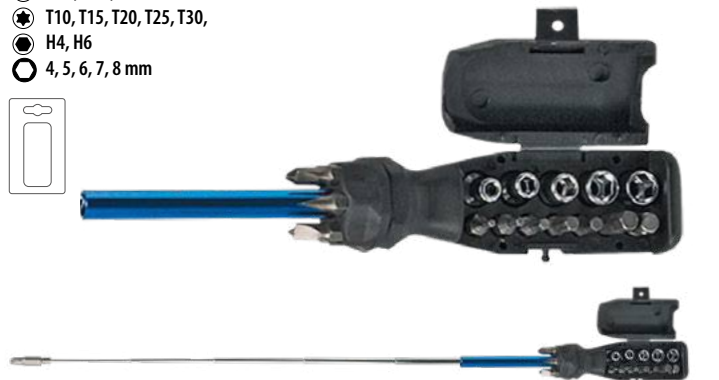

Ref. 39D183  
L min [mm] 200  
L max [mm] 500  
EAN 5902062053152



## Końcówki wkrętakowe z uchwytem

Screwdriver bits with holder / Einsätze für Schraubendreher mit Aufnahme / Набор насадок с держателем / Наконечники викруткові, з рукояттям / Csavarhúzó cserélhető feje / Set biti cu suport capat / Šroubovákové nástavce s držadlem / Skrutkovacie nástavce s upínadlom / Nastavki za izvijač z vpenjalom / Atskaktuvo antgaliai su laikikliu / Skrivgrieža uzgaļu komplekts ar turētāju / Krivkeeraajatsakud koos käepidemega / Накариници за отвертка с держач / Nastavci za odvijač s hvataljkom / Nastavci za odvijač s drškom / Σετ με καταβιδώματα και προσαρμογέα / Puntas destornilladoras con mango / Set inserti con supporto / Ponteiros Chave de fenda com Suporte / Embouts de tournevis de précision avec manche / Schroevendraaiereinstukken met handvat

NEO TOOLS

25 years GUARANTEE

TÜV Rheinland CERTIFIED

SUPER HARD S2 steel

x99

1/4"



- ⊖ 3, 4, 4.5, 5.5, 6, 6.5, 7, 8 mm
- ⊕ PH0, PH1, PH2x5, PH3
- ⊕ PZ0, PZ1x2, PZ2x5, PZ3
- ⊕ T8, T10, T15, T20, T25, T27, T30, T40, T45
- ⊕ TT8, TT10, TT15, TT20, TT25, TT27, TT30, TT35, TT40
- H1.5, H2, H2.5, H3, H4, H5, H5.5, H6, H8
- H1/16, H5/64, H3/32, H7/64, H1/8, H9/64, H5/32, H3/16, H7/32, H1/4"
- HT2, HT2.5, HT3, HT4, HT5, HT6
- 5/64, 3/32, 7/64, 1/8, 9/64, 5/32"
- M5, M6, M8
- ⊕ 4, 6, 8, 10 mm
- ⊖ 2, 3, 4 mm
- ⊖ 1, 2, 3 mm
- ⊖ 6, 8, 10 mm
- No0, No1, No2, No3

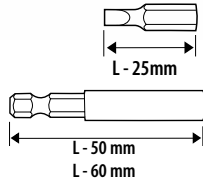

Ref. 06-104 6/24 EAN 5907558406245

NEO TOOLS

25 years GUARANTEE

TÜV Rheinland CERTIFIED

SUPER HARD S2 steel

1/4"

x31

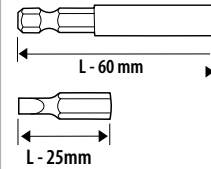

- ⊖ 3, 4, 5, 6 mm
- ⊕ PH1, 2xPH2, PH3
- ⊕ PZ1, 2xPZ2, PZ3
- H3, H4, H5, H6
- T10, T15, T20, T25, T27, T30, T40
- TT10, TT15, TT20, TT25, TT27, TT30, TT40

Ref. 06-103 6/24 EAN 5907558402346

NEO TOOLS

25 years GUARANTEE

TÜV Rheinland CERTIFIED

SUPER HARD S2 steel

1/4"

x32

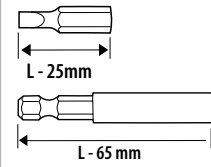

- ⊖ 3, 4, 5, 6 mm
- ⊕ PH1, 2xPH2, PH3
- ⊕ PZ1, 2xPZ2, PZ3
- H3, H4, H5, H6
- T10, T15, T20, T25, T27, T30, T40
- TT10, TT15, TT20, TT25, TT27, TT30, TT40

Ref. 06-106 12/48 EAN 5907558410143

NEO TOOLS

25 years GUARANTEE

TÜV Rheinland CERTIFIED

S2 steel

x38

1/4"

48



- ⊖ 3, 4, 5, 6 mm
- ⊕ PH1x2, PH2x2, PH3x2
- ⊕ PZ1x2, PZ2x2, PZ3x3
- T10, T15, T20, T25, T27, T30, T40
- TT10, TT15, TT20, TT25, TT27, TT30, TT40
- H2, H2.5, H3, H4, H5, H6

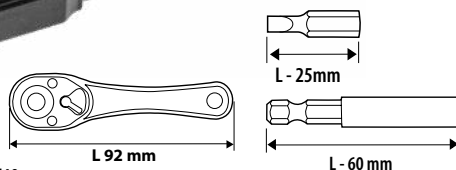

Ref. 06-105 6/36 EAN 5907558402315

NEO TOOLS

25 years GUARANTEE

TÜV Rheinland CERTIFIED

S2 steel

x7

1/4"

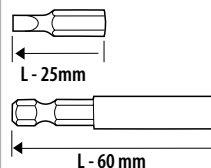

- ⊖ 4, 5, 6 mm
- ⊕ PH1, PH2
- T15, T20

Ref. 06-101 12/120 EAN 5907558402339





## Końcówki wkrętakowe z uchwytem

Screwdriver bits with holder / Einsätze für Schraubendreher mit Aufnahme / Набор насадок с держателем / Наконечники викруткови, з рукоятям / Csavarhúzó cserélhető fejjű / Set biti cu suport capat / Šroubovákové nástavce s držadlem / Skrutkovacie nástavce s upínadlom / Nastavki za izvijač z vpenjalom / Atsuktavo antgaliai su laikikliu / Skrūvgrieža uzgaļu komplekts ar turētāju / Krivikeerajaotsakud koos käepidemega / Накрайники за отвертка с держач / Nastavci za odvijač s hvataljkom / Nastavci za odvijač s drškom / Σετ με καταβιδόμυτες και προσαρμογέα / Puntas destornilladoras con mango / Set inserti con supporto / Ponteiros Chave de fenda com Suporte / Embouts de tournevis de précision avec manche / Schroevendraaiereindstukken met handvat

**TOPEX**

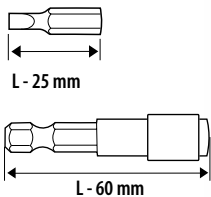

- ⌀ 4; 5; 6; 7 mm
- ⊕ PH1; PH2; PH3
- ⊕ PZ1; PZ2; PZ3
- ⊕ T10; T15; T20; T25
- ⊕ H3; H5; H6

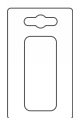

Ref. 39D363    12/72    EAN 5902062393630

**CrV**  
**x18**  
**1/4"**

**TOPEX**



- ⌀ 5; 6 mm
- ⊕ PH1; PH2 x 2; PH3
- ⊕ PZ1; PZ2; PZ3
- ⊕ T15; T20; T25



Ref. 39D518    12/48    EAN 5902062395184

**CrV**    **x14**    **1/4"**

**TOPEX**

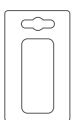
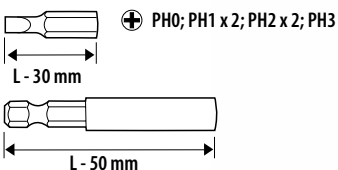

Ref. 39D350    12/96    EAN 5902062393500

**CrV**    **x7**

**TOPEX**

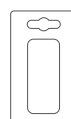
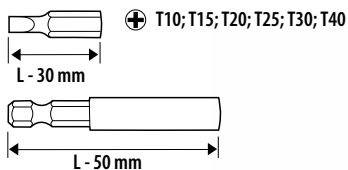

Ref. 39D351    12/96    EAN 5902062393517

**CrV**    **x7**

**TOP TOOLS**

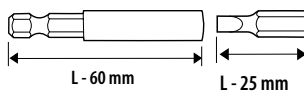

- ⊕ T8, T10, T15, T20, T25, T27, T30, T35, T40
- ⊕ 5/64", 3/32", 7/64", 1/8", 9/64", 5/32"
- ⊕ H2, H2.5, H3, H4, H5, H6
- ⊕ 4, 6, 8, 10
- ⊕ 1, 2, 3, 4
- ⊕ 6, 8, 10

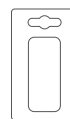

Ref. 39D355    6/48    EAN 5902062053008

**x33**

**TOP TOOLS**

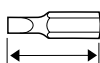

- ⌀ 5, 6, 7 mm
- ⊕ PH0, PH1, PH2, PH3
- ⊕ PZ0, PZ1, PZ2, PZ3
- ⊕ T10, T20, T30, T40

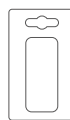
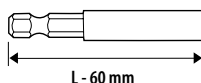

Ref. 39D383    20/100    EAN 5902062393838

**x16**

**TOP TOOLS**

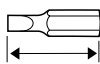

- ⌀ 4, 5, 6 mm
- ⊕ PH1, PH2, PH3
- ⊕ PZ1, PZ2

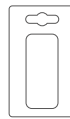
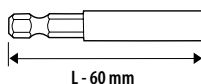

Ref. 39D381    18/180    EAN 5902062050502

**x7**

**TOP TOOLS**

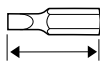

- ⌀ 5, 6 mm
- ⊕ PH1, PH2, PH3

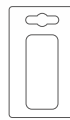

Ref. 39D180    0/100    EAN 5902062051431

**x6**

**TOP TOOLS**

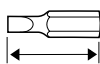

- ⌀ 4, 5, 6 mm
- ⊕ PH1, PH2, PH3
- ⊕ PZ1, PZ2



Ref. 39D181    15/90    EAN 5902062051363

**x9**    **L/R**



## Końcówki wkrętakowe z uchwytem

Screwdriver bits with holder / Einsätze für Schraubendreher mit Aufnahme / Набор насадок с держателем / Наконечники викрутковой, з рукоятям / Csavarhúzó cserélhető fejű / Set biti cu suport carat / Šroubovákové nástavce s držadlem / Skrutkovacie nástavce s upínadlom / Nastavki za izvijač z vpenjalom / Atsuktuvo antgaliai su laikikliu / Skrivgrieža uzgaļu komplekts ar turētāju / Kruvikeeraajatsakud koos käepidemega / Нақрайицуи за отворетки с държач / Nastavci za odvijač s hvataljkom / Nastavci za odvijač s drškom / Σετ με κατασβιδόμετες και προσαρμογέα / Puntas destornilladoras con mango / Set inserti con supporto / Panteiros Chave de fenda com Suporte / Embouts de tournevis de précision avec manche / Schroevendraaiereindstukken met handvat

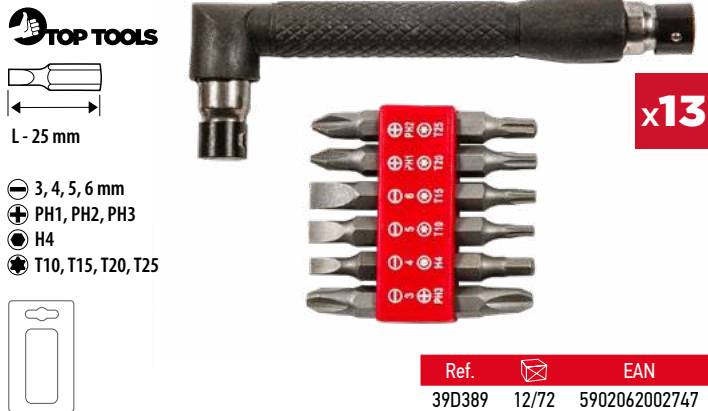

- ⊖ 3, 4, 5, 6 mm
- ⊕ PH1, PH2, PH3
- ⊕ H4
- ⊙ T10, T15, T20, T25

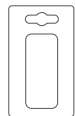

Ref. 39D389 EAN 12/72 5902062002747

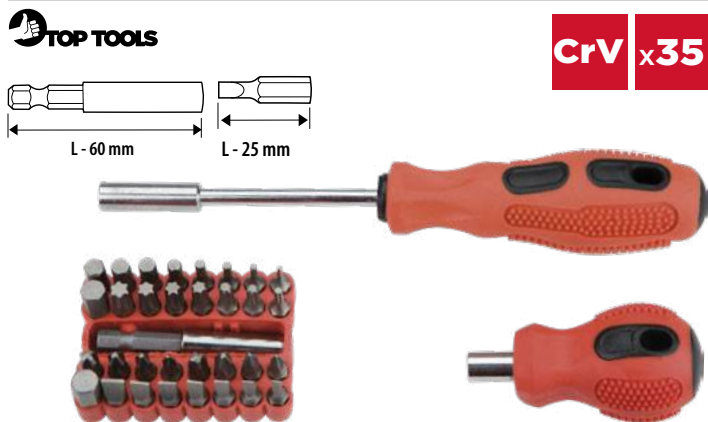

- ⊖ 3, 4, 4.5, 5, 5.5, 6, 7 mm
- ⊕ PH0, PH1, PH2, PH3
- ⊕ PZ0, PZ1, PZ2, PZ3
- ⊙ T10, T20, T25, T27, T30, T35, T40
- ⊙ H1.5, H2, H2.5, H3, H4, H5, H5.5, H6, H7, H8



Ref. 39D456 EAN 0/40 5902062394569



- ⊖ 3, 4, 4.5, 5, 5.5, 6, 6.5, 7, 8
- ⊕ PH0, PH1, PH2, PH3
- ⊕ PZ0, PZ1, PZ2, PZ3
- ⊙ T8, T10, T15, T20, T25, T27, T30, T40, T45
- ⊙ TT8, TT10, TT15, TT20, TT25, TT27, TT30, TT40, TT45
- ⊙ H1.5, H2, H2.5, H3, H4, H5, H5.5, H6, H8
- ⊙ H1/16", H5/64", H3/32", H7/64", H1/8", H9/64", H5/32", H3/16", H7/32", H1/4"
- ⊙ HT2, HT2.5, HT3, HT4, HT5, HT6
- ⊙ HT5/64", HT3/32", HT7/64", HT1/8", HT9/64", HT5/32"
- ⊙ 1, 2, 3, 4
- ⊕ 6, 8, 10
- ⊕ 4, 6, 8, 10
- ⊙ 5, 6, 8
- ⊙ 0, 1, 2, 3
- ⊖ 1, 2, 3

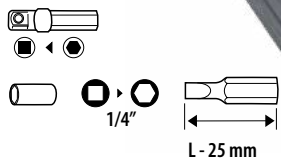

Ref. 39D358 EAN 0/20 5902062431004

## Końcówki wkrętakowe i nasadki z uchwytem

Driver bits and sockets with handle / Ein- und Aufsätze für Schraubendreher mit Aufnahme / Набор сменных головок и насадок с держателем / Наконечники викрутковой и насадки з рукоятям / Bit és dugókulcskészlet / Capete de șurubelniță și tubulare cu mâner / Šroubovákové nástavce a nástavce s držadlem / Koncovky skrutkovača a nástavce s držiakom / Nastavki za izvijače z vpenjalom / Sukimo antgaliai ir laikikliai su kotu / Skrivgriežu nomaināmās galviņas un uzgaļi ar turētāju / Kruvikeeraajatsakud ja padrunid koos käepidemega / Нақрайицуи и наставкаи за отворетки с държач / Nastavci za odvijač i kاپice s hvataljkom / Nastavci za odvijač i nasadke s drškom / Σετ με ανταλλακτικές μύτες και καρυδιάκια με αντίποτα / Puntas destornilladoras y vasos con mango / Set di inserti e bussole con cricchetto / Panteiros chave de fenda e bocais com suporte / Embouts et douilles avec manche / Schroevendraaiereindstukken en doppen met handvat



- ⊖ 3; 4; 5; 6; 7 mm
- ⊕ PH1; PH2; PH3
- ⊕ PZ1; PZ2; PZ3
- ⊙ T10; T15; T20; T30
- ⊙ H3; H4; H5; H6; H8



- 5; 6; 7; 8; 9; 10; 11; 12; 13 mm

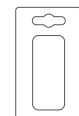

Ref. 39D522 EAN 6/36 5902062395221

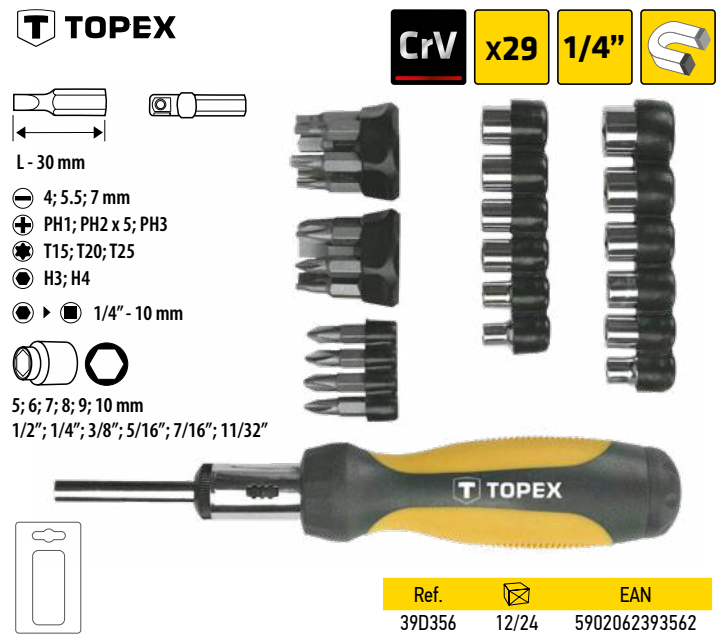

- ⊖ 4; 5.5; 7 mm
- ⊕ PH1; PH2 x 5; PH3
- ⊙ T15; T20; T25
- ⊙ H3; H4
- ⊙ 1/4" - 10 mm



- 5; 6; 7; 8; 9; 10 mm
- 1/2"; 1/4"; 3/8"; 5/16"; 7/16"; 11/32"

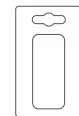

Ref. 39D356 EAN 12/24 5902062393562



- ⊖ 6; 7; 8; 9; 10; 11 mm
- ⊖ 4; 7 mm
- ⊕ PH1; PH2
- ⊕ PZ1; PZ2; PZ3
- ⊙ T10; T15; T20

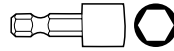

Ref. 39D361 EAN 12/72 5902062431103

## Końcówki wkrętakowe i nasadki z uchwytem

Driver bits and sockets with handle / Ein- und Aufsätzen für Schraubendreher mit Aufnahme / Набор сменных головок и насадок с держателем / Наконечники викрутковой и насадки с рукояткой / Bit és dugókulcskészlet / Capete de șurubelniță și tubulare cu mâner / Šroubovácové nástavce a nástavce s držadlem / Koncovky škrutkovača a nástavce s držakom / Nastavki za izvijače z vpenjalom / Sukimo antgialiai ir laikikliai su kotu / Skrūvgrieži nomainomās galviņas un uzgaļi ar turētāju / Krūvikeerajaotsakud ja padrunid koos käepidemega / Накрайници и наставки за отвертки с держач / Nastavci za odvijač i kapice s hvataljkom / Nastavci za odvijač i nasadke s drškom / Σετ με ανταλλακτικές μύτες και καρδιάκια με αντάπορα / Puntas destornilladoras y vasos con mango / Set di inserti e bussolle con cricchetto / Ponteiros chave de fenda e bocais com suporte / Embouts et douilles avec manche / Schroevendraaierinstukken en doppen met handvat

**TOPEX**

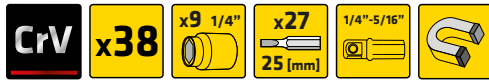

- ⊖ 3, 4, 5, 6 mm
- ⊕ PH0, PH1, PH2, PH3
- ⊕ PZ0, PZ1, PZ2, PZ3
- ⊕ T10, T15, T20, T25, T27, T30
- ⊕ H2, H3, H4, H5, H6
- ⊕ S0, S1, S2, S3
- 1/4": 4, 5, 6, 7, 8, 9, 10, 11, 12, mm



Ref. 39D344    6/24    EAN 5902062034199

**TOPEX**

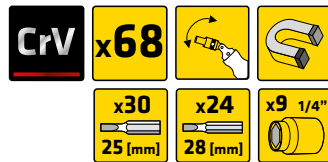

- ⊖ 3, 4, 5, 6 mm
- ⊕ PH0, PH1, PH2, PH2, PH3
- ⊕ PZ0, PZ1, PZ2, PZ3
- ⊕ T10, T15, T20, T20, T25, T25, T27, T30
- ⊕ H3, H4, H5, H6
- ⊕ S0, S1, S2, S3

- ⊖ 1, 1.5, 2, 2.5, 3, 3.5, 4 mm
- ⊕ PH000, PH000, PH00, PH0, PH1
- ⊕ PZ0, PZ1
- ⊕ T4, T5, T6, T7, T8
- ⊕ H0.7, H0.9, H1.3, H1.5, H2

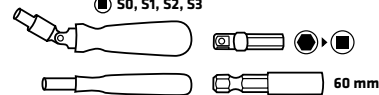

- 1/4": 4, 5, 6, 7, 8, 9, 10, 11, 12, mm



Ref. 39D346    5/20    EAN 5902062034212

**TOPEX**

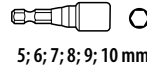
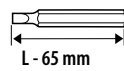

- ⊖ 3; 4; 5; 6; 7 mm
- ⊕ PH0; PH1 x 2; PH3
- ⊕ PZ1; PZ2; PZ3
- ⊕ T15; T20; T25

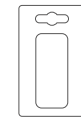

Ref. 39D352    6/24    EAN 5902062393524

**TOPEX**

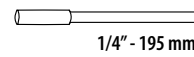

- ⊖ 4; 4.5; 5; 5.5; 6; 7; 8; 9; 10 mm
- ⊕ 13/32"; 3/8"; 11/32"; 1/4"; 7/32"; 3/16"; 5/32"

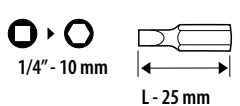

L - 25 mm

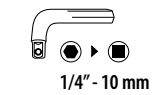

- ⊖ 3; 4; 4.5; 5; 5.5; 6; 7 mm
- ⊕ PH1; PH2; PH3
- ⊕ PZ1; PZ2; PZ3
- ⊕ H3/32"; H1/8"; H5/32"; H3/16"
- ⊕ T20; T30



Ref. 39D369    0/12    EAN 5902062393692

**TOP TOOLS**

x22  
CrV

- ⊖ 4, 5, 6 mm
- ⊕ PH1, PH2, PH3
- ⊕ PZ1, PZ2, PZ3



Ref. 39D185    0/12    EAN 5902062053428



## Końcówki wkrętakowe i nasadki z uchwytem

Driver bits and sockets with handle / Ein- und Aufsätze für Schraubendreher mit Aufnahme / Набор сменных головок и насадок с держателем / Наконечники викрутковой и насадки с рукояткой / Bit és dugókulcskészlet / Capete de șurubelniță și tubulare cu mâner / Šroubovácové nástavce a nástavce s držadlem / Koncovky skrutkovača a nástavce s držakom / Nastavki za izvijače z vpenjalom / Sukimo antgaliai ir laikikliai su kotu / Skrūvgręzių nomainiamas galviņas un uzgaļi ar turētāju / Krūvīkeeraojatsakud ja padrunid koos käepidemega / Накрайници и наставки за отвертки с держач / Nastavci za odvijač i kapice s hvataljkom / Nastavci za odvijač i nasadke s držkom / Σετ με ανταλλακτικές μύτες και καρυδιάκια με αντάτορα / Puntas destornilladoras y vasos con mango / Set di inserti e bussole con cricchetto / Ponteiros chave de fenda e bocais com suporte / Embouts et douilles avec manche / Schroevendraaiereindstukken en doppen met handvat

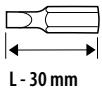

L - 30 mm

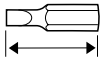

L - 50 mm



6, 7, 8, 9, 10, 11, 12 mm  
3/16", 1/4", 5/16", 11/32",  
3/8", 7/16", 1/2"



x52

- ⊖ 3, 4, 5, 6 mm
- ⊕ PH0, PH1, PH2, PH3
- ⊕ PZ0, PZ1, PZ2, PZ3
- T10, T15, T20, T25, T27, T30, T40
- H1.5, H2, H2.5, H3, H4, H5, H5.5, H6



Ref. 39D357 0/20 EAN 5902062053107



- ⊖ 3, 4, 5, 6 mm
- ⊕ PH1, PH2, PH3
- ⊕ PZ1, PZ2, PZ3
- T10, T15, T20, T25, T27, T30, T40



4, 5, 6, 7, 8, 9, 10, 11, 12 mm



x21

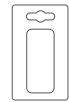

Ref. 39D385 30/60 EAN 5902062050526

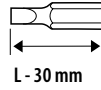

L - 30 mm

- ⊖ 5, 6, 7 mm
- ⊕ PH1, PH2, PH3
- ⊕ PZ1, PZ2
- T10, T15, T20, T25, T27, T30, T40
- 1/16, 5/64, 3/32, 1/8, 5/32, 3/16, 7/32, 1/4



6, 7, 8, 9, 10, 11, 12 mm  
3/16, 1/4, 5/16, 11/32, 3/8,  
7/16, 1/2"



x40

1/4"

Ref. 39D386 0/30 EAN 5902062051646



- ⊖ 3, 4, 5, 6 mm
- ⊕ PH0, PH1, PH2, PH3
- ⊕ PZ0, PZ1, PZ2, PZ3
- T10, T15, T20, T25
- H2, H3, H4, H5
- S0, S1, S2, S3



4, 5, 6, 7, 8, 9, 10, 11, 12,  
5/32", 3/16", 1/4", 9/32",  
5/16", 11/32", 3/8", 7/16", 1/2"

25  
MM  
18 PCS



x44

CrV

Ref. 39D200 6/24 EAN 5902062035769

## Uchwyt do końcówek

Bit holder / Aufnahme für Spitzen / Зажим для наконечников / Тримач до наконечників / Csavarbehajtászár / Dispozitiv de prinderea capetelor / Skličidlo na nástavce / Upínadlo na nástavce / Vpenjalo za nastavke / Laikiklis antgaliams / Uzgaļu patrona / Otsakupadrin / Держачка за накрайници / Drška za nastavke / Hvat za nastavke / Προσαρμογέας μπιτών / Mandril de sujeción para puntas / Inneșto per inserti con impugnatura / Suporte de ponteiros / Manche pour embouts / Houder voor eindstukken

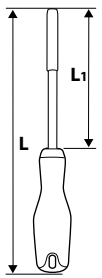

Ref. 06-078 L[mm] 215 Li[mm] 100 12/180 EAN 5907558414417

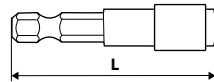

Ref. 06-070 L [mm]. 65 10/100 EAN 5907558403497

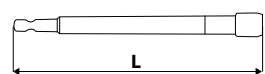

Ref. 06-072 150 12/96 EAN 5907558410105  
06-073 300 12/48 EAN 5907558410112

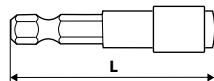

Ref. 06-071 L [mm]. 60 20/200 EAN 5907558405385



## Uchwyt do końcówek

Bit holder / Aufnahme für Spitzen / Зажим для наконечников / Тримач до наконечників / Csavarbehajtószer / Dispozitiv de prinderea capetelor / Skličidlo na nástavce / Upínadlo na nástavce / Vpenjalo za nastavke / Laikikkis antgaliams / Uzgāju patrona / Otsakupadrun / Держач за накруйниці / Drška za nastavke / Hvata za nastavke / Προσαρμογέας μπιτών / Mandril de sujeción para puntas / Innești per inserti con impugnatura / Suporte de ponteiros / Manche pour embouts / Houder voor eindstukken

**T TOPEX**

1/4"

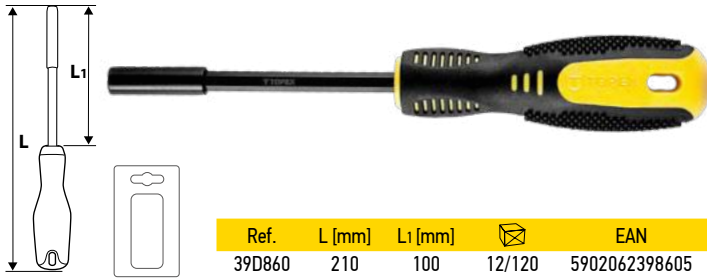

Ref.	L [mm]	L1 [mm]	⊠	EAN
39D860	210	100	12/120	5902062398605

**T TOPEX**

X5

1/4"

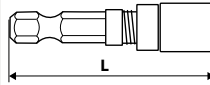

⊕ PH2 x 2  
⊕ PZ2 x 2



L - 25 mm

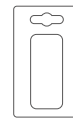

Ref.	L [mm]	⊠	EAN
39D340	65	20/120	5902062393401

**T TOPEX**

1/4"

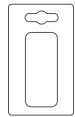
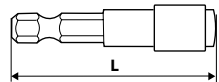

Ref.	L [mm]	⊠	EAN
39D337	60	50/200	5902062430052

**T TOPEX**

1/4"

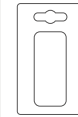
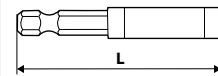

Ref.	L [mm]	⊠	EAN
39D341	80	50/200	5902062393418

**T TOPEX**

1/4"

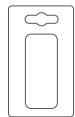
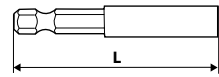

Ref.	L [mm]	⊠	EAN
39D338	60	0/400	5902062430069

**TOP TOOLS**

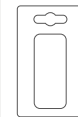

Ref.	L [mm]	⊠	EAN
39D339	145	12/120	5902062393395

## Nasadki wkrętaskowe

Socket bits / Schraubendrehereinsätze / Насадки / Насадки викруткови / Csavarbehajtó készlet / Tubulare cu antrenor bit / Šroubovákové nástavce / Skrutkovacie nástavce / Nasadni ključiči za izvijač / Sukimo antgaliiai / Skrūvgriežu uzgali / Krūvīķerājaparadrunid / Насадки за отвертка / Карпце одвijaча / Nasadke za odvijac / Μύτες / Vasos destornilladores / Bussole per trapano / Bocais de Chaves de fenda / Douilles de tournevis / Doppen voor schroevendraaiers

**T TOPEX**

CrV

X8

1/4"

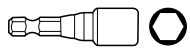

5; 6; 7; 8; 9; 10; 11; 13 mm

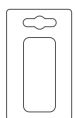

Ref.	⊠	EAN
39D387	25/100	5902062043498

## Redukcje

Adapter set / Reduzierstücke / Переходники / Перехідники, набір / Adapterkészlet / Set adaptoare / Redukcje / Súprava redukcií / Garnitura adapterjev / Adapterių komplektas / Pāreju komplekts / Adapterite komplekt / Αδανμορ / Produženi adapter / Adapter set / Συλλογή προσαρμοστών / Adaptador a cuadro / Adattatore / Reduções / Réductions / Reductiestukken

**T TOPEX**

X3

1/4"

3/8"

1/2"

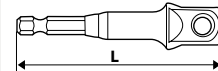

1/4" L - 65 mm

3/8" L - 65 mm

1/2" L - 75 mm

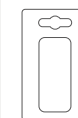

Ref.	⊠	EAN
38D151	24/144	5902062381514



## Końcówki wkrętakowe

Driver bits / Einsätze für Schraubendreher / Насадки / Наконечники викрутки / Csavarhúzó hegyek / Set biti / Šroubovácové nástavce / Skrutkovacie nástavce / Nastavki za izvijače / Atsuktuvo antgaliai / Skrivgrieža uzgaļi / Krivikeeraajatsakud / Накрайници за отвертка / Nastavci za odvijač / Nastavci za odvijač / Καταβιδόμενες / Puntas destornilladoras / Inserti / Ponteiros de chave de fenda / Embouts de tournevis / Schroevendraaiereindstukken

**NEO**  
TOOLS

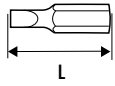

**DIN**  
3126

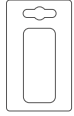

Ref.	+	L[mm]	⊠	EAN
06-011	PH2	25	12/120	5907558406351

**NEO**  
TOOLS

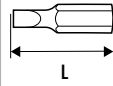

**DIN**  
3126

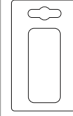

Ref.	+	L[mm]	N	⊠	EAN
06-020	PZ2	25	x20	50/150	5907558403015

**NEO**  
TOOLS

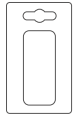
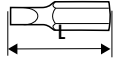

Ref.	+	L[mm]	N	⊠	EAN
06-036	PH2	25	x10	50/150	5907558403121
06-037	PH2	50	x5	50/200	5907558403138

**NEO**  
TOOLS

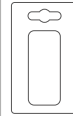

Ref.	+	⊠	EAN
06-040	PH2	24/192	5907558410099

**TOPEX**

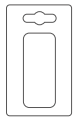
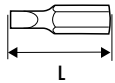

Ref.	+	L[mm]	⊠	EAN
39D314	PH2	25	10/300	5902062432100

**TOP TOOLS**

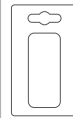
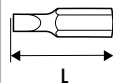

Ref.	+	L [mm]	⊠	EAN
39D382	PH2	60	0/100	5902062050519

**x10**

## Szpikulec

Point chisel / Spicknadel / Наконечник / Шило / Ár / Tijă ascuțită / Hrot / Šidlo / Igla za pretikanje / Yla / Saurumsitis / Naaskel / Шило / Šiljak / Probadač, šilo / Μύτη / Púa / Punteruolo / Ponta / Pointe / Puntbeitel

**NEO**  
TOOLS

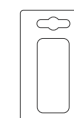

Ref.	⊠	EAN
04-037	12/120	5907558435917

## Haki

Hooks / Hacken / Ξύγκυ / Гаки / Horgok / Cârlige / Háky / Skoby / Kļjuke / Kabliai / Άγκι / Haagid / Куки / Kuke / Kuke / Γάντζοι / Ganchos / Ganci / Anzóis / Crochets / Haken

**TOP TOOLS**



Ref.	L [mm]	⊠	EAN
39D173	150	12/96	5902062002723

**x4**



## Wkręтак ударowy

Impact screwdriver / Schlag-Schraubendreher / Отвертка ударная / Вкрутка ударна / Ütvecsavarozó / Surubelnija ču pecutor / Šroubovák rázový / Rázový skrutkovač / Udarni izvijač / Smūginis suktuvus / Trieciens skrūvgriezis / Löökkruvikeeraja / Ударна отвертка / Odvijač s udarom / Udarni odvijač / Καταβίβι κρούσης / Destornillador de impacto / Cacciavite a percussione / Chave de fenda de impacto / Tournevis à chocs / Slagschroevendraaier

NEO  
TOOLS

25  
years  
GUARANTEE

TÜV Rheinland  
CERTIFIED

S2  
steel

CrV  
steel

x11



TOPEX

CrV x7



5, 6, 8, 10, 12, 14 mm  
PH1, PH2, PH3



Ref.	m[kg]	⊠	EAN
04-250	1,2	0/12	5907558410082



7; 8 mm  
PH2; PH3



Ref.	⊠	EAN
39D556	0/20	5902062395566

## Wkręтак akumulatorowy

Cordless Screwdriver / Akku-Schraubendreher / Отвертка аккумуляторная / Шрубоверт аккумуляторний / Akkumulátoros csavarozó / Surubelnija ču acumulator / Akumulátorový šroubovák / Akumulátorový skrutkovač / Akumulatorski vijačnik / Akumulatorinis suktuvus / Akumulatora skrūvgriezis / Akukruvikeeraja / Аккумуляторна отвертка / Akumulatorski odvijač / Akumulatorski odvijač / Εναρφαρτιζόμενο καταβίβι / Destornillador a batería / Avvitatore a batteria / Chave de fenda de bateria / Tournevis à batteries / Accu schroevendraaier



NEO  
TOOLS



Ref.	⊠	EAN
04-200	0/16	5907558439380



## Wkrętak płaski 1000V

Screwdriver slotted / Flachsraubendreher / Отвертка плоская / Відкрутка плоска / Csavarhúzó / Šurubelnitá platá / Šroubovák plochý / Skrutkovač plochý / Ploščati izvijač / Ploščias atsuktuvos / Skrūvgriežis plakans / Lamepa-kruvikeeraja / Отвертка / Odvijač / Odvijac / Καταβίδι εγκοπής / Destornillador plano / Giravite piatto 1000V / Chave de fenda plana / Tournevis à fourche / Vlakke schroevendraaier

NEO TOOLS



Ref.	⌀ [mm]	L [mm]	L <sub>1</sub> [mm]	⊠	EAN
04-051	2,5	150	75	12/600	5907558401998
04-052	3,0	175	100	12/240	5907558402001
04-053	4,0	205	100	12/240	5907558402018
04-054	5,5	230	125	12/144	5907558402025
04-055	6,5	270	150	12/144	5907558402032

NEO TOOLS



Ref.	⌀ [mm]	L [mm]	L <sub>1</sub> [mm]	⊠	EAN
04-130	0,4	175	75	12/120	5907558433227
04-131	0,6	195	100	12/120	5907558433234
04-132	0,8	198	100	12/120	5907558433241
04-133	1,0	230	125	12/120	5907558433258

TOPEX



Ref.	⌀ [mm]	L [mm]	L <sub>1</sub> [mm]	⊠	EAN
39D470	2,5	175	70	80/320	5902062394705
39D471	3,0	205	100	60/240	5902062394712
39D472	4,0	210	100	50/200	5902062394729
39D473	5,5	245	125	30/120	5902062394736

## Wkrętak krzyżowy PH 1000V

Screwdriver Phillips / Kreuzschraubendreher / Отвертка крестовая / Відкрутка крестовидна / Csavarhúzó philips / Šurubelnitá tip „Phillips“ / Šroubovák křížový / Skrutkovač PH / Křížni izvijač / Kryžminis atsuktuvos Phillips / Skrūvgriežis krusta PH / Ristpeakruvikeeraja / Отвертка / Odvijač / Odvijac / Καταβίδι σταυρωτό τύπου philips / Destornillador philips / Giravite Phillips / Chave de fenda de cruzeta / Tournevis en croix / Kriusschroevendraaier



Ref.	⊕	L [mm]	L <sub>1</sub> [mm]	⊠	EAN
04-071	PH0	135	60	12/600	5907558402070
04-072	PH1	190	80	12/240	5907558402087
04-073	PH2	215	100	12/144	5907558402094

NEO TOOLS



Ref.	⊕	L [mm]	L <sub>1</sub> [mm]	⊠	EAN
04-137	PH0	160	60	12/120	5907558433296
04-138	PH1	185	80	12/120	5907558433302
04-139	PH2	210	100	12/120	5907558433319
04-140	PH2	285	175	12/120	5907558433326

TOPEX



Ref.	⊕	L [mm]	L <sub>1</sub> [mm]	⊠	EAN
39D475	PH0	270	60	80/320	5902062394750
39D476	PH1	195	80	40/160	5902062394767
39D477	PH2	220	100	30/120	5902062394774

## Wkrętak krzyżowy PZ 1000V

Screwdriver Pozidriv / Kreuzschraubendreher / Отвертка крестовая / Відкрутка крестовидна / Csavarhúzó pozidriv / Šurubelnitá tip „Pozidriv“ / Šroubovák křížový / Skrutkovač PZ / Křížni izvijač / Kryžminis atsuktuvos Phillips / Skrūvgriežis krusta PZ / Ristpeakruvikeeraja Pozidriv / Отвертка / Odvijač / Odvijac / Καταβίδι τύπου pozidriv / Destornillador philips / Giravite Pozzi 1000V / Chave de fenda de cruzeta / Tournevis en croix / Kriusschroevendraaier

NEO TOOLS



NEO TOOLS



Ref.	⊕	L [mm]	L <sub>1</sub> [mm]	⊠	EAN
04-136	PZ2	210	100	12/120	5907558433289

TOPEX



Ref.	⊕	L [mm]	L <sub>1</sub> [mm]	⊠	EAN
39D479	PZ1	195	80	40/160	5902062394798
39D480	PZ2	220	100	30/120	5902062394804

Ref.	⊕	L [mm]	L <sub>1</sub> [mm]	⊠	EAN
04-062	PZ1	190	80	12/240	5907558402056
04-063	PZ2	217	100	12/144	5907558402063



## Wkrętak plus-minus 1000V

Screwdriver / Kreuzschraubendreher / Отвертка крестовая / Відкрутка крестовидна / Csavarhúzó / Şurubeliňňä / Šroubovák křížový / Skrutkovač / Křížni izvijač / Kryžminis atsuktuvas / Skrūvgriezis krusta / Ristpeakruvikeeraja / Отвертка / Odvijáč / Odvijac / Καταβίδι σταυρωτό τύπου / Destornillador phillips / Giravite / Chave de fenda de cruzeta / Tournevis en croix / Kriusschroevendraaier

**NEO**  
TOOLS



Ref.	⊖ ⊕	L[mm]	L <sub>1</sub> [mm]	📦	EAN
04-221	SL/PZ2	220	100	12/144	5907558432398
04-222	SL/PH2	220	100	12/144	5907558432404

## Wkrętaki 1000V

Screwdriver set / Schraubendreher / Отвертки / Відкрутки, набір / Csavarhúzókészlet / Set şurubeliňňä / Šroubováky / Súprava skrutkovačov+bity / Komplet izvijačev / Atsuktuvų komplektas / Skrūvgriežu komplekts / Kruvikeerajate komplekt / Отвертки компл. / Odvijáč / Odvijac set / Συλλογή καταβιδιών / Destornilladores / Set giraviti 1000V / Chaves de fenda / Tournevis / Schroevendraaiers

**NEO**  
TOOLS

- ⊖ 2.5x75 mm, 4x100 mm, 6.5x150 mm
- ⊕ PH1x80 mm, PH2x100 mm

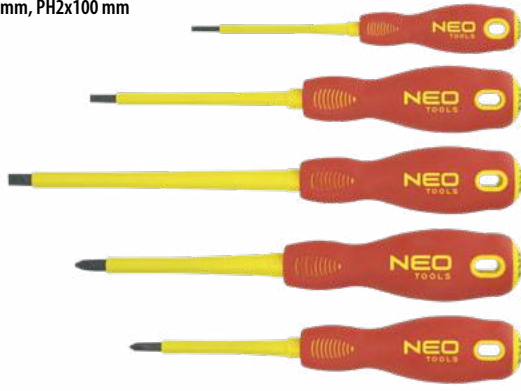

Ref.	📦	EAN
04-220	6/36	5907558402278

**NEO**  
TOOLS



- ⊖ 0.6x100mm, 0.8x100mm, 1.0x100mm, 1.2x100mm, 1.6x175mm
- ⊕ PH0x60 mm, PH1x80 mm, PH2x100 mm, PH3x150 mm

Ref.	📦	EAN
04-142	0/12	5907558433340

**NEO**  
TOOLS

- ⊖ 3x100 mm, 4x100 mm, 5.5x125 mm, 6.5x150 mm, 8x175 mm
- ⊕ PH0x60mm, PH1x80 mm, PH2x100 mm, PH3x150 mm



Ref.	📦	EAN
04-143	0/12	5907558433357

## TOPEX

**CrMo**



- ⊖ 3x75 mm, 5.5x125 mm, 6.5x150 mm
- ⊕ PH1x80 mm, PH2x100 mm



125-250V

Ref.	📦	EAN
39D673	6/24	5902062396730

## TOPEX

**CrMo**



- ⊖ 3x100 mm, 4x100 mm, 5.5x100 mm
- ⊕ PH1 x 80 mm, PH2 x 100 mm



Ref.	📦	EAN
39D150	0/10	5902062391506

## TOPEX

125-250V

**CrMo**



- ⊖ 3x100 mm, 4x100 mm, 5.5x100 mm
- ⊕ PH1 x 80 mm, PH2 x 100 mm



Ref.	📦	EAN
39D155	0/10	5902062051776



## Wkrętaki 1000V

Screwdriver set / Schraubendreher / Отвертки / Відкрутки, набір / Csavarhúzókészlet / Set şurubelişte / Šroubováky / Súprava skrutkovačov+bity / Komplet izvijičev / Atsuktuvų komplektas / Skrivgriežu komplekts / Krivikeerajate komplekt / Отвертки компл. / Odvijáč / Odvijac set / Συλλογή καταβίδιών / Destornilladores / Set giraviti 1000V / Chaves de fenda / Tournevis / Schroevendraaiers

**T TOPEX**

⊖ 4 x 100 mm,  
5.5 x 125 mm,  
6.5 x 150 mm

⊕ PH0 x 60 mm,  
PH1 x 80 mm,  
PH2 x 100 mm,  
PH3 x 150 mm

**CrMo**

**1000V**

**X8**

125-250V

Ref.	☒	EAN
39D674	0/20	5902062396747

## Końcówki wkrętakowe z uchwytem 1000V

Screwdriver bits with holder / Einsätze für Schraubendreher mit Aufnahme / Набор насадок с держателем / Наконечники викруткові, з ручіям / Csavarhúzó cserélhető fejtű / Set biti cu suport carat / Šroubovákové nástavce s držadlem / Skrutkovicke nástavce s upinadlom / Nastavki za izvijač z vpenjalom / Atsuktuvų antgaliai su laikikliu / Skrivgrieža uzgāļu komplekts ar turētāju / Krivikeerajatsakud koos käepidemega / Накрайници за отвертка с държач / Nastavci za odvijáč s hvataljkom / Nastavci za odvijáč s drškou / Σετ με καταβιδιώματα και προσαρμογέα / Puntas destornilladoras con mango / Set inserti con supporto / Ponteiros Chave de fenda com Suporte / Embouts de tournevis de précision avec manche / Schroevendraaiereinstukken met handvat

**NEO TOOLS**

1000V, 100mm

SL: 2.0, 2.5, 3.0, 3.5, 4.0, 5.5, 6.5

PH: 0, 1, 2

**1000V**

**S2 steel**

**54-61 HRC**

**x12**

QUICK CHANGE



Ref.	☒	EAN
01-308	0/20	5907558435597

**NEO TOOLS**

**1000V S2 54-61 HRC x50**

1000V, 100mm

⊖ SL: 2.0 / 2.5 / 3.0 / 3.5 / 4.0 / 5.5 / 6.5

⊕ PH: PH0 / PH1 / PH2 ⊕ PZ: PZ0 / PZ1 / PZ2

⊙ T: T6 / T8 / T9 / T10 / T15 / T20 / T25 / T27 / T30

⊙ H: H2.5 / H3.0 / H4.0 / H5.0 / H6.0

⊙ R: R1 / R2

⊙ TRI: TRI 1 / TRI 2 / TRI 3 / TRI 4

⊙ TORO: TORO 4 / TORO 6 / TORO 8 / TORO 10

⊙ M: M4 / M5 / M6 ⊕ U: U4 / U6 / U8 / U10

1000V, 89mm

⊙ 6.3 / 8.1

250 V CE

QUICK CHANGE



Ref.	☒	EAN
01-309	0/10	5907558435603

## Nasadka sześciokątna 1000V

Hexagonal socket / Sechskanteinsatz / Головка сменная шестигранная / Насадка шестигранна / Dugókulcs / Cheie tubulara hexagonala / Šestihranný nástavec / Šesthranný nástavec / Šestkotni natični nastavek / Šešiakampis antgalis / Sešstūra nomaināmā galva / Kuuskantpadrun / Шестозъелна наставка / Šesterokutna kapica / Šestougaona nasadka / Καρβύδα εξάγωνο / Vaso para destornillador hexagonal / Bussola esagonale / Bocal hexagonal / Douille à 6 pans / Zeskant dop

**NEO TOOLS**



**25 years GUARANTEE**

**TUV Rheinland CERTIFIED**

**1000V**

**CrV steel**

**1/2"**



Ref.	W[mm]	☒	EAN
01-181	10	12/108	5907558432893
01-182	11	12/108	5907558432909
01-183	12	12/108	5907558432916
01-184	13	12/108	5907558432923
01-185	14	12/108	5907558432930
01-186	16	12/108	5907558432947
01-187	17	12/108	5907558432954
01-188	18	12/108	5907558432961
01-189	19	12/108	5907558432978
01-190	21	11/110	5907558432985
01-191	22	11/110	5907558432992
01-192	24	11/110	5907558433005
01-193	27	15/105	5907558433012
01-194	30	10/90	5907558433029
01-195	32	10/90	5907558433036

## Grzechotka 1000V

Ratchet handle / Ratsche / Трещотка / Держак з тріскотною / Racsnikulcs / Miner de hurluitoare / Řehtačka / Račňa prepínacia / Raglja / Terkslè / Reversa atslèga / Pörkratta pide / Трещотка / Račva za nasadni ključ / Racva za gedoru / Κατσάνα / Llave de carraca / Cricchetto / Catraca de furar / Clé à cliquet / Ratel

**NEO TOOLS**

**25 years GUARANTEE**

**TUV Rheinland CERTIFIED**

**CrV steel**

**1000V**

**1/2"**

**250 mm**



Ref.	☒	EAN
01-180	4/28	5907558432817

## Klucze sześciokątne 1000V

Hex key / Sechskantschlüssel / Ключи шестигранные / Ключ шестигранный / Imbuskulcs készlet / Set chei cu șase laturi / Šestihranný klíč / Súprava imbus klúčov (dlhé) / Garnitura imbus ključev / Šešiakampij raktu komplektas / Seškanšu atslègu komplekts / Kuuskant-mutrivõtmete komplekt / Лумбуси компл. / Ključ imbus set / Ključ imbus set / Συλλογή εξαγωνικών κλειδιών / Llaves Allen / Chiavi esagonali / Chaves hexagonais / Clefs à 6 pans / Zeskantsleutels

**NEO TOOLS**

**25 years GUARANTEE**

**TUV Rheinland CERTIFIED**

**CrV steel**

**1000V**



Ref.	● [mm]	☒	EAN
01-171	3	8/72	5907558432824
01-172	4	8/72	5907558432831
01-173	5	6/72	5907558432848
01-175	8	8/48	5907558432862
01-176	10	8/48	5907558432879
01-177	12	6/36	5907558432886



## Klucz płaski jednostronny 1000V

Open single end spanner / Maulschlüssel einseitig / Ключ рожковый односторонний / Ключ рожковый / Villáskulcs / Cheie piulță unilaterală cu cavitatea deschisă / Plochý klíč jednostranný / Klíč vidlicový jednostranný / Viličasti ključ / Ploščias vienpusis raktas / Ragatšlēga / Ūhe avatud otsaga vīti / Ключ Гаечен / Кљуџ viljuškasti / Кљус viljuškasti / Мово џерманкó клеиџ / Llave fija de una boca / Chiave a forchetta / Chave plana / Clef à fourche simple / Eenzijdig vlakke sleutel

NEO  
TOOLS



Ref.	● [mm]	☒	EAN
01-110	6	9/108	5907558432411
01-111	7	9/108	5907558432428
01-112	8	9/108	5907558432435
01-113	9	9/108	5907558432442
01-114	10	9/108	5907558432459
01-115	11	9/108	5907558432466
01-116	12	9/108	5907558432473
01-117	13	9/108	5907558432480
01-118	14	8/72	5907558432497
01-119	15	8/72	5907558432503
01-120	16	8/72	5907558432510
01-122	18	8/72	5907558432534
01-123	19	8/72	5907558432541
01-124	21	6/54	5907558432558
01-125	22	6/54	5907558432565
01-126	24	6/54	5907558432572
01-127	27	6/36	5907558432589
01-128	30	6/36	5907558432596
01-129	32	6/36	5907558432602

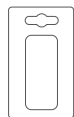

## Konektory

Electric connectors set / Steckverbinder-Set / Коннекторы набор / Коннектори, набір / Kábelarukészlet / Conectori set / Konektory súprava / Konektory / Komplet elektrických príkrúčkov / Elektrosvungjűngök rínkiny / Elektrisko savienotāju komplekts / Elektrīstīkute komplekt / Комплект электрически съединители / Komplet elektrických konektorů / Комплект электрических коннекторов / Σετ ηλεκτρικών συνδετήρων / Juego de conectores eléctricos / Set di connettori / Conjunto de conectores eléctricos / Jeu de connecteurs électriques / Elektrische connectoren set

NEO  
TOOLS

x420



x15 6.3 mm 11-10 AWG 4.0-6.0 mm <sup>2</sup>	x15 6.3 mm 11-10 AWG 4.0-6.0 mm <sup>2</sup>	x30 4.8 mm 20-17 AWG 0.5-1.0 mm <sup>2</sup>	x30 4.8 mm 20-17 AWG 0.5-1.0 mm <sup>2</sup>	x50 2.8 mm 20-17 AWG 0.5-1.0 mm <sup>2</sup>	x50 2.8 mm 20-17 AWG 0.5-1.0 mm <sup>2</sup>
x15 M10 20-17 AWG 0.5-1.0 mm <sup>2</sup>	x15 M8 20-17 AWG 0.5-1.0 mm <sup>2</sup>	x20 M5 20-17 AWG 0.5-1.0 mm <sup>2</sup>	x30 4.0 mm 20-17 AWG 0.5-1.0 mm <sup>2</sup>	x15 4.0 mm 20-17 AWG 0.5-1.0 mm <sup>2</sup>	x15 4.0 mm 20-17 AWG 0.5-1.0 mm <sup>2</sup>
x15 M10 15-13 AWG 1.5-2.5 mm <sup>2</sup>	x15 M8 15-13 AWG 1.5-2.5 mm <sup>2</sup>	x20 M5 15-13 AWG 1.5-2.5 mm <sup>2</sup>	x30 4.8 mm 15-13 AWG 1.5-2.5 mm <sup>2</sup>	x30 4.8 mm 15-13 AWG 1.5-2.5 mm <sup>2</sup>	x10 6.3 mm 15-13 AWG 1.5-2.5 mm <sup>2</sup>

Ref.	☒	EAN
01-535	0/36	5907558439366

## Klucze nasadowe 1000V

Socket wrenches / Steckschlüssel / Набор сменных головок / Ключи торцевые / Dugókulcskészlet / Trusa tubulare / Nástrčné kľúče / Nástrčné klúče / Nasadni ključji / Veržlerakčio antgaliai / Nomaināmo galvu komplekts / Radgrunvõtmed / Сменными накрайници за ключове / Nasadni ključevni / Кључевни натикаџи / Σετ με καρδιάκια / Llaves de vaso / Set di bussolle SuperLock / Chaves tubulares / Clefs à douilles / Dopsleutels

NEO  
TOOLS

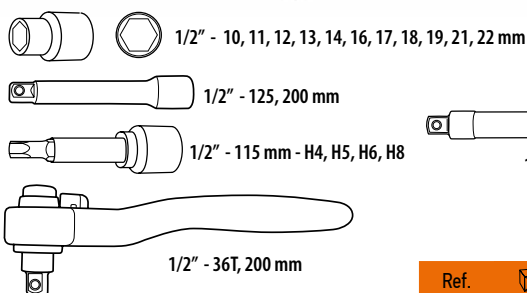

Ref.	☒	EAN
01-306	0/3	5907558435573

NEO  
TOOLS

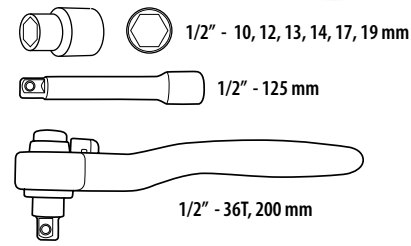

Ref.	☒	EAN
01-307	0/5	5907558435580



## Skrzynia serwisowa elektryka 52 szt.

Electrician's tool box 52 pcs / Servicekasten für Elektriker 52-teilig / Инструментальный ящик электрика 52 шт. / Инструментальный ящик электрика 52 шт. / Villanyzerelő koffer, 52 db / Cutie scule electrician 52 piese / Elektrikářský servisní box 52 ks / Elektrikářska skrinka s náradím 52 ks / Servisni kovček elektrikařa 52 kos. / Įrankių dėžė elektrikui 52 vnt. / Elektriķa instrumentu kaste 52 gab. / Elektriku tööriistakast 52 tk / Куфар с инструменти за електротехник 52 бр. / Servisni ormar za električare 52 kom. / Servisna kutija električara 52 kom. / Βαλίτσα εργαλείων ηλεκτρολόγου 52 τμχ / Caja de servicio de eléctrico 52 uds. / Cassetta portautensili per elettricista 52 pz. / Kit de 52 ferramentas de electricista em caixa / Caisse à outil électricien / Gereedschapkoffer van elektricien 52 st.

**NEO**  
TOOLS

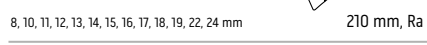
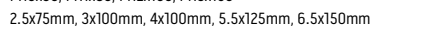
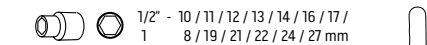
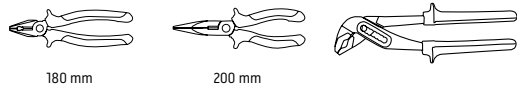
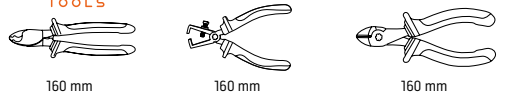

Ref.	Icon	EAN
01-311	0/1	5907558439991

## Walizka elektryka

Electrician's suitcase / Elektriker-Koffer / Чемодан электрика / Valiza elektrika / Villanyzerelő koffer / Valiza electricianului / Kufr elektrikaře / Elektrikářský kufrík / Kovček za električarje / Lagaminas elektrikiui / Elektriķa instrumentu koferis / Elektriku kovher / Куфарче на електротехник / Kovček za električare / Koffer električara / Βαλίτσα εργαλείων ηλεκτρολόγου / Maletin de eléctrico / Valigetta da elettricista / Mala de eletricista / Malette à outils pour électricien / Gereedschapstas elektricien



**NEO**  
TOOLS

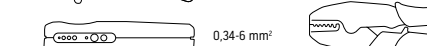
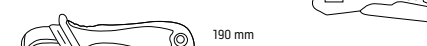
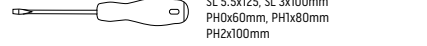
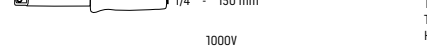
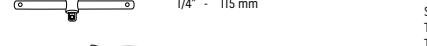
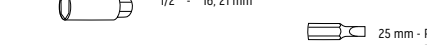
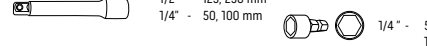
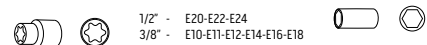
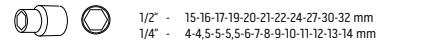

Ref.	Icon	EAN
01-310	0/2	5907558431957



## Próbnik instalacji elektrycznej

Voltage tester / Elektroprüfgerät / Отвертка-индикатор / Відкрита-індикатор напруги / Fázisceruza / Aparat de măsurat presiunea / Zkoušečka elektrické instalace / Skúšačka elektro / Preizkuševalec napetosti / El. itampos testeris / Testeris elektroinstalacijai / Voltmeter / Фазомер / Ispitivač / Glinerica / Δοκιμαστικό καταβίδι ηλεκτρικής εγκατάστασης / Destornillador buscapolos / Voltmetro / Testador de instalação elétrica / Testeur d'installation électrique / Tester van de elektrishe installatie

**TOPEX**

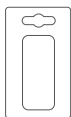

Ref.	U [V]	L [mm]	☒	EAN
39D067	3-500	175	0/20	5901182000022

**TOPEX**

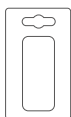

Ref.	U [V]	L [mm]	☒	EAN
39D066	3-500	155	0/25	5902062051240

**TOPEX**

**250V**

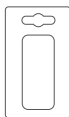

Ref.	U [V]	L [mm]	☒	EAN
39D058	125-250	140	30/240	5902062390585

**TOPEX**

**250V**

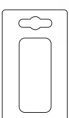

Ref.	U [V]	L [mm]	☒	EAN
39D055	220-250	140	12/600	5902062051592

**TOPEX**

**250V**

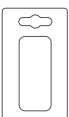

Ref.	U [V]	L [mm]	☒	EAN
39D054	100-250	190	20/500	5902062504982

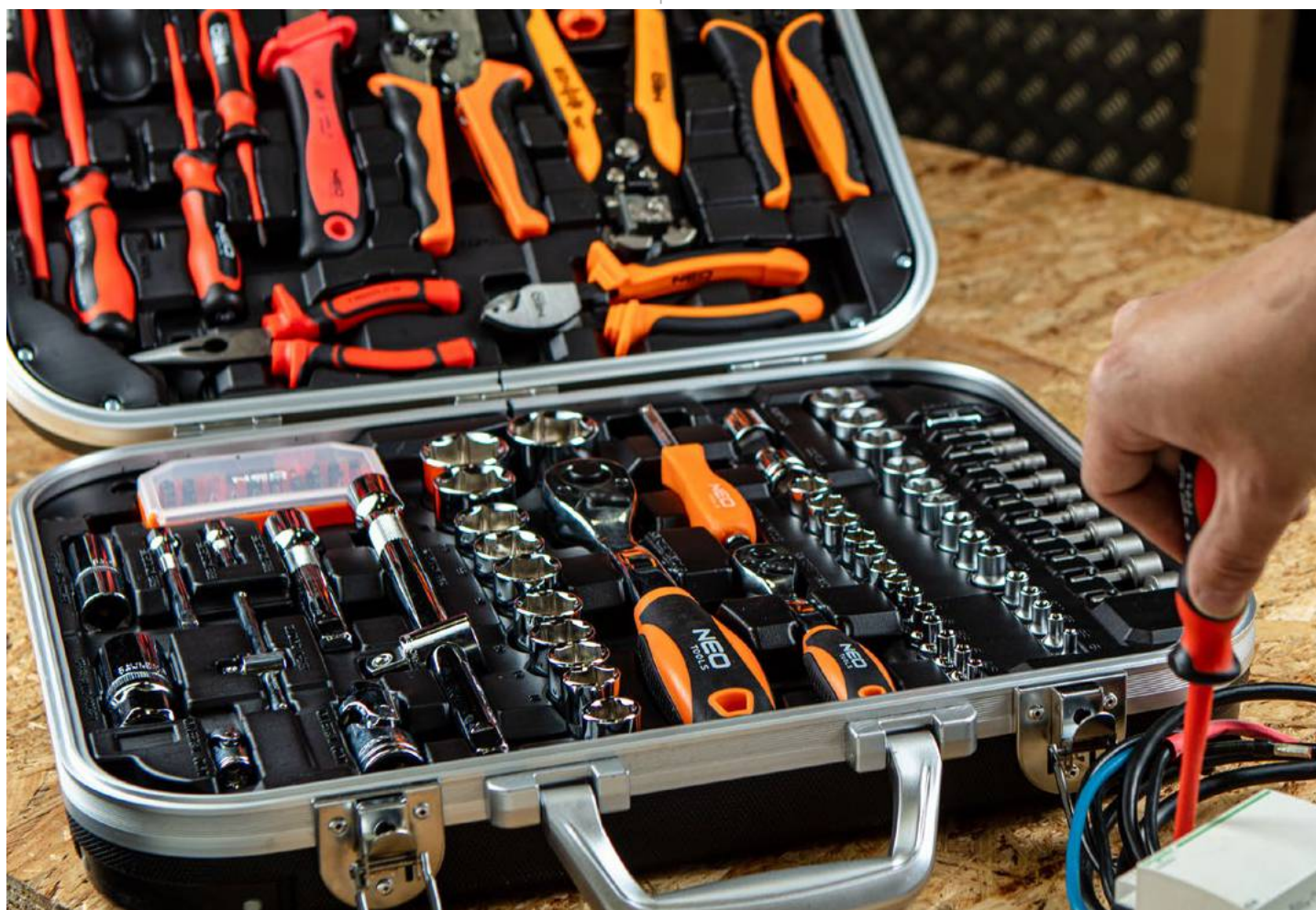



# SZCZYPCY

PLIERS ЩИПЦІ

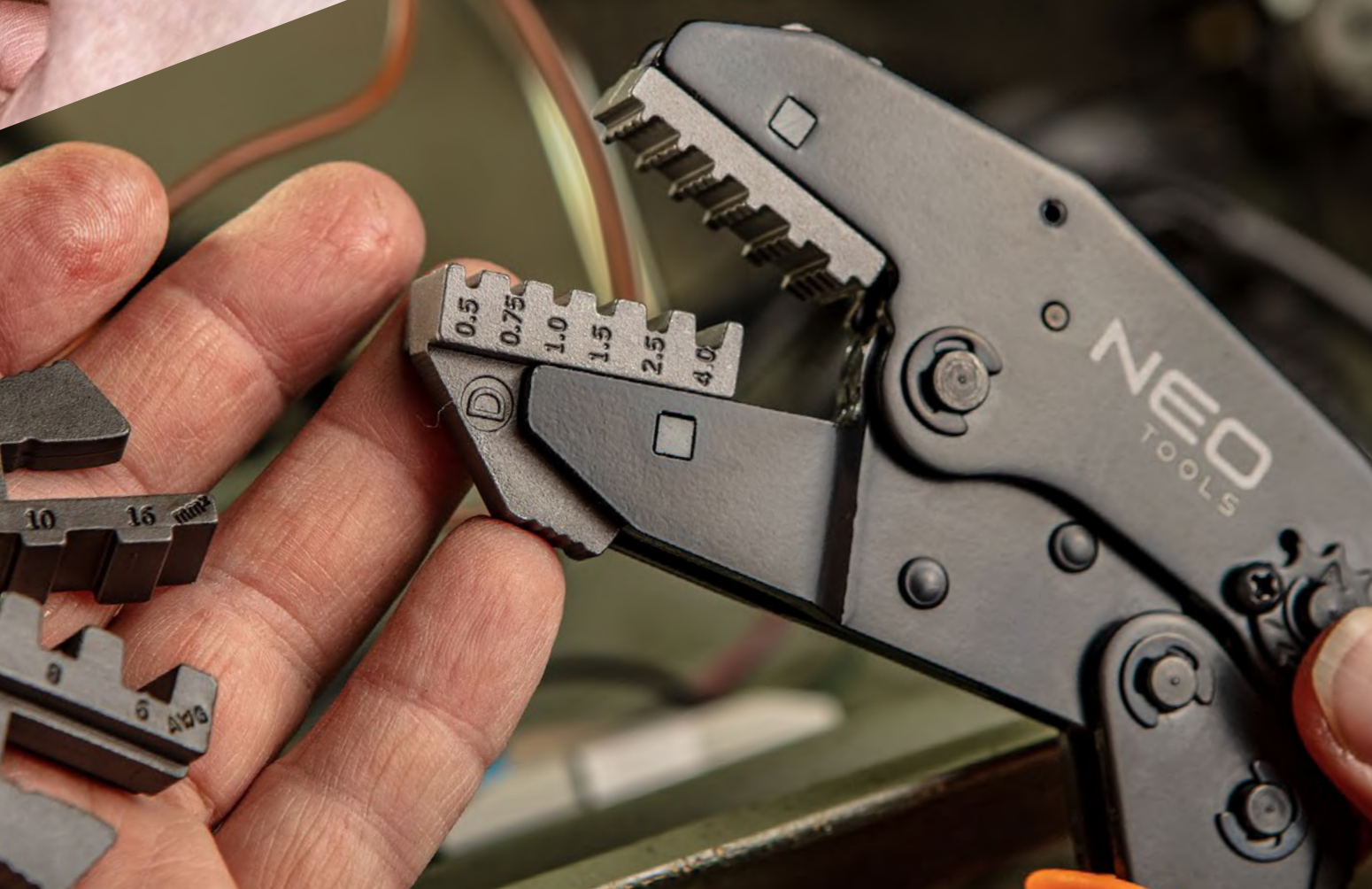

## Szczypce uniwersalne

Combination pliers / Kombizange / Пассатижи / Пасатижи / Kombinált fogó / Clește universal / Kombinované kleště / Kliešte kombinované / Kombinirane klešče / Universalios replės / Plakanknaibles kombinētās / Universaalnāpītsad / Клещи комбинируни / Kombinirana klijesta / Kombinovana klesta / Πένσα γενικής χρήσης / Alicates universales / Pinza universale / Pinças universais / Pince universelle / Universele tang

**NEO**  
TOOLS

25  
years  
GUARANTEED

TÜV Rheinland  
CERTIFIED

55-60  
HRC

DIN  
5746



Ref.	L[mm]	☒	EAN
01-010	160	6/48	5907558401547
01-011	180	6/48	5907558401554
01-012	200	6/48	5907558401561

**NEO**  
TOOLS



SOFT  
handle

TPR  
ABS

HARDENED

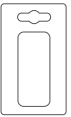

Ref.	L[mm]	☒	EAN
01-250	160	6/60	5907558443646
01-251	180	6/60	5907558443653

**TOPEX**

CARBON  
STEEL

Ergo  
design

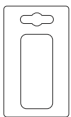

Ref.	L[mm]	☒	EAN
32D098	160	6/60	5902062320988
32D099	180	6/48	5902062320995
32D100	200	6/60	5902062321008

**TOP TOOLS**

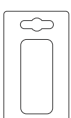

Ref.	L[mm]	☒	EAN
32D110	160	6/60	5902062010025
32D111	180	6/60	5902062010032
32D112	200	6/60	5902062010049

**NEO**  
TOOLS

40%  
FORCE  
SAVE

HIGH  
LEVERAGE

MORE USES

CrNi  
steel

POWER  
PLIERS

58-64  
HRC



- budowa głowicy oszczędza 40% siły przy standardowym nacisku
- head design saves 40% of force with standard pressure
- конструкция напоры экономит 40% усилий при стандартном тиску

Ref.	L[mm]	☒	EAN
01-152	180	6/48	5907558448511
01-153	200	6/48	5907558448528

## Szczypce wydłużone proste

Combination pliers / Kombizange / Пассатижи / Пасатижи / Hosszúcsőrű fogó / Clește universal / Kombinované kleště / Kliešte kombinované / Kombinirane klešče / Universalios replės / Plakanknaibles kombinētās / Universaalnāpītsad / Клещи комбинируни / Kombinirana klijesta / Kombinovana klesta / Πένσα γενικής χρήσης / Alicates universales / Pinza a becco lungo / Pinças retas prolongadas / Pince allongée droite / Lange rechte tang

**NEO**  
TOOLS

25  
years  
GUARANTEED

TÜV Rheinland  
CERTIFIED

55-60  
HRC

DIN  
5745



Ref.	L[mm]	☒	EAN
01-013	160	6/48	5907558401578
01-014	200	6/48	5907558401585

**NEO**  
TOOLS

SOFT  
handle

TPR  
ABS

HARDENED

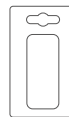

Ref.	L[mm]	☒	EAN
01-252	160	6/60	5907558443660
01-253	180	6/60	5907558443677

**NEO**  
TOOLS

40%  
FORCE  
SAVE

HIGH  
LEVERAGE

POWER  
PLIERS

CrNi  
steel

58-64  
HRC

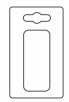

- budowa głowicy oszczędza 40% siły przy standardowym nacisku
- head design saves 40% of force with standard pressure
- конструкция напоры экономит 40% усилий при стандартном тиску

Ref.	L[mm]	☒	EAN
01-154	160	6/48	5907558448535
01-155	200	6/48	5907558448542



## Szczypce wydłużone proste

Combination pliers / Kombizange / Пассажухи / Пасатухи / Hosszúcsőrű fogó / Clește universal / Kombinované kleště / Kliešte kombinované / Kombinirane klešče / Universālios replės / Plakanknaibles kombinētās / Universaālāpřisad / Клеци комбинарни / Kombinirana klijesta / Kombinovana klesta / Πένια γενικής χρήσης / Alicates universales / Pinza a becco lungo / Pinças retas prolongadas / Pince allongée droite / Lange rechte tang

**TOPEX**

**CARBON STEEL**  
**Ergo design**

**TOP TOOLS**

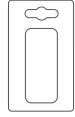

Ref.	L[mm]	☒	EAN
32D101	160	6/60	5902062321015

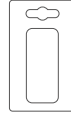

Ref.	L[mm]	☒	EAN
32D113	160	12/120	5902062010056
32D115	200	6/60	5902062010063

## Szczypce wydłużone wygięte

Long nose bent pliers / Zange lang, gebogen / Плоскогубцы удлиненные изогнутые / Ципци видоизмененные / Rövidcsőrű fogó / Clește varf ascuțit indoit / Kleště prodloužené vyhnuté / Kliešte predĺžené vyhnuté / Koničaste klešče - upognjene / Prailgintos replės, lenktos / Izliektas pagarinātas knaibles / Pikkade kövrate otstęga nāpřisad / Клеци удължени огънати / Izdužena savinuta klijesta / Izdužena savijena klešta / Μυτατομήπιδο κυρτό / Alicate Teléfono curvo / Pinza a becco curvo / Pinças curvadas prolongadas / Pince allongée coudées / Lange gebogen tang

**NEO TOOLS**

**25 years GUARANTEE**  
**TÜV Rheinland CERTIFIED**  
**55-60 HRC**  
**DIN 5745**

**NEO TOOLS**

**SOFT handle**  
**TPR ABS**  
**HARDENED**

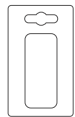
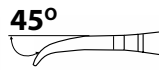
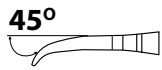

Ref.	L[mm]	☒	EAN
01-015	160	6/48	5907558401592
01-016	200	6/48	5907558401608

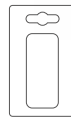

Ref.	L[mm]	☒	EAN
01-254	160	6/60	5907558443684
01-255	180	6/60	5907558443691

**TOPEX**

**CARBON STEEL**  
**Ergo design**

**TOP TOOLS**

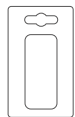
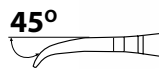
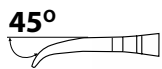

Ref.	L[mm]	☒	EAN
32D103	160	6/60	5902062321039

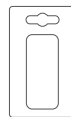

Ref.	L[mm]	☒	EAN
32D114	160	12/120	5902062010070
32D116	200	6/60	5902062010087

## Szczypce boczne

Diagonal cutting pliers / Seitenzange / Бокорезы / Бокорізи / Oldalcsípő fogó / Clește ascuțit diagonal de tăiat sîrmă / Boční kleště / Cvikačky bočné / Stranske klešče / Šoninės replės / Sānknaibles / Diagonaal-lōiketangid / Клеци Ресачки / Klijesta svikerice / Klesta poluokruga / Πλαγιόκόφτης / Alicates diagonales / Tronçese laterale / Pinças laterais / Pince latérale / Zijtang

**NEO TOOLS**

**TÜV Rheinland CERTIFIED**  
**25 years GUARANTEE**  
**55-60 HRC**  
**DIN 5749**

**NEO TOOLS**

**SOFT handle**  
**TPR ABS**  
**HARDENED**

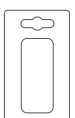

Ref.	L[mm]	☒	EAN
01-017	160	6/48	5907558401615
01-018	180	6/48	5907558401622

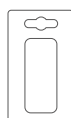

Ref.	L[mm]	☒	EAN
01-256	160	6/60	5907558443707
01-257	180	6/60	5907558443714





## Szczypce boczne

Diagonal cutting pliers / Seitenzange / Бокорезы / Бокорізи / Oldalcsípó fogó / Clește ascuțit diagonal de tăiat sîrmă / Боčni kleště / Cvikačky боčné / Stranske klešče / Sonines replės / Sānknaibles / Diagonaal-lijketangid / Клеци Рєзачки / Klijesta cvikerice / Klesta polukrugla / Πλαγκοκόφτης / Alicates diagonales / Tronchese laterale / Pinças laterais / Pince latérale / Zijtang

**NEO**  
TOOLS

40% FORCE SAVE HIGH LEVERAGE POWER PLIERS CrNi steel 58-64 HRC



- budowa głowicy oszczędza 40% siły przy standardowym nacisku
- head design saves 40% of force with standard pressure
- конструкция напору экономит 40% усилия при стандартном тиску

Ref.	L[mm]	⊠	EAN
01-156	160	6/48	5907558448559
01-157	180	6/48	5907558448566

**NEO**  
TOOLS

40% FORCE SAVE HIGH LEVERAGE POWER PLIERS CrNi steel 58-64 HRC



- budowa głowicy oszczędza 40% siły przy standardowym nacisku
- head design saves 40% of force with standard pressure
- конструкция напору экономит 40% усилия при стандартном тиску

Ref.	L[mm]	⊠	EAN
01-158	180	6/48	5907558448573

**TOPEX**

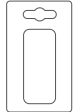

**Ergo design**

Ref.	L[mm]	⊠	EAN
32D138	180	6/48	5902062011701

**TOPEX**

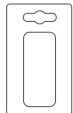

**CARBON STEEL Ergo design**

Ref.	L[mm]	⊠	EAN
32D106	160	6/60	5902062321060
32D107	180	6/60	5902062321077

**TOP TOOLS**

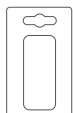

Ref.	L[mm]	⊠	EAN
32D118	160	6/60	5902062010100
32D119	180	6/60	5902062010650

## Szczypce okrągłe

Round nose pliers / Rundzange / Κηρολοβύτι / Κηρολοβύτι / Kerekcsőrű fogó / Clește rotund / Kulaté kleště / Klešte s okružlou čelustou / Okrogle klešče / Arvalios replės / Αραλκναibles / Ümarmokk-nápisad / Клеци Чокки / Klijesta okrugla / Klesta okrugla / Μυτσαίμηθο με στρογγυλά ράμφη / Alicates redondas / Pinza a becca tonda / Pinças redondas / Pince ronde / Ronde tang

**NEO**  
TOOLS

25 years GUARANTEE TÜV Rheinland CERTIFIED DIN 5745

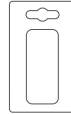

Ref.	L[mm]	⊠	EAN
01-020	160	6/48	5907558401646

**TOPEX**

**CARBON STEEL Ergo design**

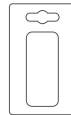

Ref.	L[mm]	⊠	EAN
32D109	160	6/60	5902062321091

**TOP TOOLS**

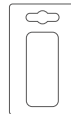

Ref.	L[mm]	⊠	EAN
32D121	160	6/60	5902062010124

## Szczypce do izolacji

Wire stripper / Isolierungszange / Бокорезы для зачистки / Бокорізи для зачищування / Kábelcsupaszoló / Clește p/ă mlăturarea izolatorului / Kleště na izolaci / Klešte odizolovacie / Klešče za snemanje izolacije / Replės izoliacijai nuimti / Knaibles izolācijai / Kaablītangid / Клеци Заголовачки за монтаж / Klesta za izolaciju / Απογυμνωτές καλωδίων / Alicates pelacables / Pinza spela fili regolabile 1000V / Pinças p. Isolação / Pince à dénuder / Isolatieltang

**TOPEX**



**CrV**

0,5±5mm<sup>2</sup>

Ref.	L[mm]	∅ [mm <sup>2</sup> ]	⊠	EAN
32D407	160	0,2 - 6,0	6/96	5902062011718

**TOP TOOLS**

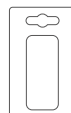

Ref.	L[mm]	∅ [mm <sup>2</sup> ]	⊠	EAN
32D401	160	0,2 - 6,0	6/96	5902062010018



## Szczypce płaskie

/ Flat nose pliers/ Zange flach / Плоскогубцы / Щипцы з плоскими губками / Laposcsőrű fogó / Cleste varf plat / Kleště ploché / Kliešte ploché / Ploščate klešče / Ploščios replės / Plakanas knaibles / Lamenāpitsad / Плоски клещи / Plosnata klijesta / Ravna klešta / Πένσα / Alicate Boca plana / Pinza a becco piatto / Pinças planas / Pince à fourches / Vlakke tang

**NEO**  
TOOLS

25  
years  
GUARANTEE

TÜVRheinland  
CERTIFIED

DIN  
5745

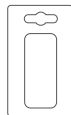

Ref.	L[mm]	⊠	EAN
01-019	160	6/48	5907558401639

**TOPEX**

**CARBON  
STEEL** Ergo  
design

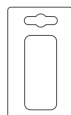

Ref.	L[mm]	⊠	EAN
32D108	160	6/60	5902062321084

**TOP TOOLS**

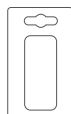

Ref.	L[mm]	⊠	EAN
32D120	160	12/120	5902062010117

## Szczypce precyzyjne płaskie

Precision flat pliers / Präzisionszange flach / Плоскогубцы прецизионные / Плоскогубці прецизійні плоскі / Laposcsőrű fogó / Cleste plat / Kleště jemná mechanika / Kliešte ploché mikro / Ploske klešče, precizne / Ploščios replės tiksliams darbams / Plakanaknaibles / Täppislatemokk-näpitsad / Клеши човки / Klijesta plosnata / Klesta pljosnata / Πλατιστήριδο ακριβείας γενικής χρήσης / Pinza di precisione a becco piatto / Pinças precisas planas / Pince de précision à fourches / Precisie vlakke tang

**NEO**  
TOOLS

25  
years  
GUARANTEE

TÜVRheinland  
CERTIFIED

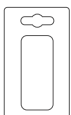

Ref.	L[mm]	⊠	EAN
01-105	130	6/96	5907558401714

## Szczypce precyzyjne uniwersalne

Precision combination pliers / Allzweck-Feinzange / Плоскогубцы прецизионные комбинированные / Кусачки прецизійні універсальні / Preciós kombinált fogó / Cleste combinat, precizie / Kleště precizní univerzální / Kliešte precízne univerzálne / Univerzalne precizne klešče / Replės precizinės, universalios / Univeršālas precizējošas knaibles / Universaalsed peennäpitsad / Универсални прецизни клещи / Univerzalna precizna klijesta / Univerzalna precizna klešta / Πένσα ακριβείας γενικής χρήσης / Alicates universales de precisión / Pinza universale di precisione / Pinças precisas universais / Pince de précision universelle / Precisie universele tang

**TOPEX**

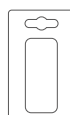

Ref.	L[mm]	⊠	EAN
32D030	120	10/100	5902062009708

**TOPEX**

Ergo  
design



Ref.	L[mm]	⊠	EAN
32D721	115	10/100	5902062132017

## Szczypce precyzyjne czółowe

Precision end cutter pliers / Stirpräzisionszange / Кусачки торцевые прецизионные / Бокорізи прецизійні / Homlokcsípő fogó / Cleste frontal / Kleště čelní jemná mechanika / Cvikačky čelné mikro / Stranske klešče, precizne / Žnyplės tiksliams darbams / Knaibles / Täppisnärpitsad otste löikamiseks / Клеши резачки / Klijesta cvikerice / Klesta sevice / Εμπροσθοκόφτης ακριβείας / Alicates frontales de precisión / Tenaglia di precisione / Pinças precisas frontais / Pince de précision frontale / Precisie hoofdtang

**NEO**  
TOOLS

25  
years  
GUARANTEE

TÜVRheinland  
CERTIFIED

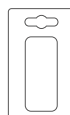

Ref.	L[mm]	⊠	EAN
01-101	115	6/96	5907558401677

**TOPEX**

Ergo  
design

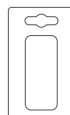

Ref.	L[mm]	⊠	EAN
32D725	115	10/100	5902062132055



## Szczypce precyzyjne wydłużone proste

Precise long nose straight pliers / Feinzange, lang, gerade / Плоскогубцы прецизионные удлиненные / Щипцы прецизійні, з видовженими, прямими губками / Hosszúcsőrű fogó / Cleste precizie-varf lung / Kleště precizní prodloužené rovné / Klešte precizne predĺžené rovné / Precizne ravne podaljšane klešče / Prailgintos precizinės replės, tiesios / Pagarinātas precizējošas plakanknaibles / Pikkade otstega peennäpitsad / Прецизни удължени клещи / Precizna izdužena jednostavna klijesta / Precizna ravna izdužena klešta / Μυτασίμυδα ακριβείας / Alicates puntas redondas larga / Pinzas de precisión a becco lungo / Pinças precisas prolongadas retas / Pince de précision allongée droite / Lange rechte precisie tang

NEO  
TOOLS

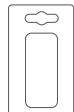
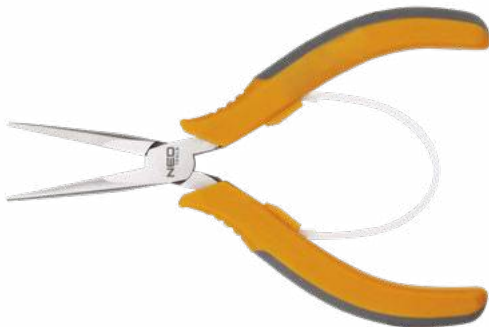

Ref.	L[mm]	☒	EAN
01-102	130	6/96	5907558401684

## TOPEX

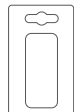

Ref.	L[mm]	☒	EAN
32D726	130	10/100	5902062132062

## TOPEX

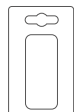

Ref.	L[mm]	☒	EAN
32D032	125	10/100	5902062009722

## TOPEX

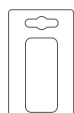

Ref.	L[mm]	☒	EAN
32D036	150	10/100	5902062009760

## Szczypce precyzyjne wydłużone wygięte

Precise long nose bent pliers / Feinzange, lang, gebogen / Плоскогубцы прецизионные удлиненные изогнутые / Щипцы прецизійні, з видовженими, вигнутими губками / Rövidcsőrű fogó / Cleste precizie-varf indoit / Kleště precizní prodloužené vyhnuté / Klešte precizne predĺžené vyhnuté / Precizne podaljšane upognjene klešče / Prailgintos precizinės replės, tiesios / Izliektas pagarinātas precizējošas plakanknaibles / Pikkade köverate otstega peennäpitsad / Прецизни удължени огънати клещи / Precizna izdužena savinuta klijesta / Precizna uvijena izdužena klešta / Μυτασίμυδα ακριβείας κυρτό / Alicates puntas curvas larga / Pinzas de precisión a becco curvo / Pinças precisas prolongadas curvadas / Pince de précision allongée coudées / Lange gebogen precisie tang

NEO  
TOOLS

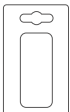

Ref.	L[mm]	☒	EAN
01-103	140	6/96	5907558401691

## TOPEX

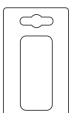

Ref.	L[mm]	☒	EAN
32D033	125	10/100	5902062009739

## TOPEX

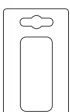
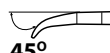

Ref.	L[mm]	☒	EAN
32D723	130	10/100	5902062132031

## Szczypce precyzyjne okrągłe

Precision round nose pliers / Präzisions-Zangen rund / Круглогубцы прецизионные / Круглогубцы прецизійні / Preciziós kerekcsőrű fogó / Clešte de precizie rotund / Kleště precizní kulaté / Klešte precizne okrúhle / Precizne klešče, okrogle / Apvalios tikslis replės / Apašlas precizas knaibles / Ūmarad tāpīsnāpītsad / Кръгли прецизни щипци / Precizna klijesta / Okrugla precizna klešta / Στρογγυλεμένα μυτασίμυδα ακριβείας / Pinzas de precisión con puntas redondas / Pinza a becco tondo di precisione / Precisie ronde tangen / Alicates precisos con pontas redondas

## TOPEX

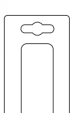

Ref.	L[mm]	☒	EAN
32D034	125	10/100	5902062009746



## Szczypce precyzyjne boczne

Precision diagonal pliers / Seitenpräzisionszange / Бокорезы прецизионные / Плоскозубці прецизійні діагональні / Oldalcsipő fogó / Clește diagonal / Kleště boční jemná mechanika / Cvikáčky bočné mikro / Čelne kleště, precízne / Šoninēs replēs tikslīems darbams / Sānknaibles / Diagonaal-tāppisnāpitsad / Клеци резачки / Klijēšta cvikerice / Klesta secice / Πλαγιοκόφτης ακριβείας / Alicates diagonales de precisión / Tranchese laterale di precisione / Pinças precisas laterais / Pince de précision latérale / Precisie zijtang

**NEO**  
TOOLS



25  
years  
GUARANTEE

TÜVRheinland  
CERTIFIED

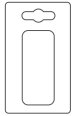

Ref.	L[mm]	⊠	EAN
01-106	110	6/96	5907558401721

**NEO**  
TOOLS



25  
years  
GUARANTEE

TPR  
ABS

65  
Mn

0,8 - 2,6 mm<sup>2</sup>  
10 - 20 AWG

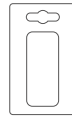

Ref.	L[mm]	∅ [mm]	⊠	EAN
01-509	140	0,8 - 2,6	10/50	5907558439281

## TOPEX



Ergo  
design

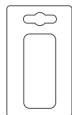

Ref.	L[mm]	⊠	EAN
32D724	115	10/100	5902062132048

## TOPEX

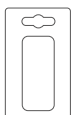

Ref.	L[mm]	⊠	EAN
32D031	113	10/100	5902062009715

## Szczypce precyzyjne

Precise pliers / Feinzange / Набор прецизионного шарнирно-зубцевого инструмента / Кусачки прецизійні / Műszerész fogókészlet / Set clești de precizie / Kleště precízni / Klijēšte precízne / Precízne kleště / Replēs, precízinēs / Precizējošās knaibles / Peennāpitsad / Клеци прецизни / Precizna klijēšta / Precizna klešta / Σετ πενσαιοίδων ακριβείας / Alicates de precisión / Set pinze di precisione / Pinças precisas / Pince de précision / Precisie tang

## TOPEX

Ergo  
design

x5

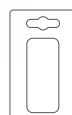
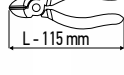
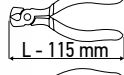
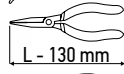
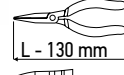
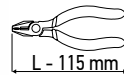

Ref.	⊠	EAN
32D755	10/40	5902062011541

## Szczypce czołowe

End cutting pliers / Frontzange / Кусачки торцовые / Щипци торцеві / Hornlokcsipő fogó / Cleste taiere frontala / Kleště čelní / Klijēšte čelnē / Čelne kleště / Kandiklēs / Kniebjamās knaibles / Otsnāpitsad / Клеци челни / Čeona klijēšta / Čeona klešta / Τανάλια / Alicate de corte frontal / Tenaglia / Pinças frontais / Pince frontale / Hoofd tang

**NEO**  
TOOLS



25  
years  
GUARANTEE

TÜVRheinland  
CERTIFIED

55-60  
HRC

DIN  
5748

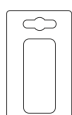

Ref.	L[mm]	⊠	EAN
01-021	160	6/48	5907558401653
01-022	200	6/48	5907558401660

## TOPEX

CrV

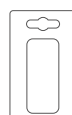

Ref.	L[mm]	⊠	EAN
32D543	160	6/60	5902062011404



## Szczypce do pierścieni osadczych

Circlip pliers / Zange für Stellringe / Щипцы для стопорных колец / Щипцы для стопорных кілец / Zégergyűrű fogó / set clește cu spirală / Kleště pro stavěcí kroužky / Segerky vonkajšie rovné / Klešče seger / Replés žiedams / Sprostgredzenu stangas / Vedrunāpītsad / Клепци Зежер / Kružna Klješta / Kružna klesta / Ασφαλισοταιμιίδες / Alicates para anillos de asiento / Pinza per anelli elastici / Pinças p. Anéis / Pince pour bagues de retenue / Tang voor dopringen

**NEO**  
TOOLS



Ref.	L[mm]	Ra [mm]	📦	EAN
01-097	170/180	19-60	4/16	5907558463606

**NEO**  
TOOLS



- zewnętrzne proste
- external, straight tip
- зовнішні/прості щипці

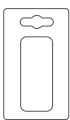

Ref.	L[mm]	Ra[mm]	📦	EAN
01-085	150	10-25	6/48	5907558440584
01-087	180	19-60	6/48	5907558440607
01-089	230	40-100	6/36	5907558440621

**NEO**  
TOOLS



- zewnętrzne wygięte
- external, bent tip
- зовнішні/вигнуті щипці

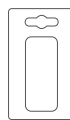

Ref.	L[mm]	Ra[mm]	📦	EAN
01-091	145	10-25	6/48	5907558440645
01-093	170	19-60	6/48	5907558440669
01-095	220	40-100	6/36	5907558440683

**NEO**  
TOOLS



- wewnętrzne proste
- internal, straight tip
- внутрішні/прості щипці

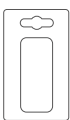

Ref.	L[mm]	Ra[mm]	📦	EAN
01-086	150	10-25	6/48	5907558440591
01-088	180	19-60	6/48	5907558440614
01-090	230	40-100	6/36	5907558440638

**NEO**  
TOOLS



- wewnętrzne wygięte
- internal, bent tip
- внутрішні/вигнуті щипці

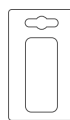

Ref.	L[mm]	Ra[mm]	📦	EAN
01-092	145	10-25	6/48	5907558440652
01-094	170	19-60	6/48	5907558440676
01-096	220	40-100	6/36	5907558440690



## Szczypce do pierścieni osadczyc

Circlip pliers / Zange für Stellringe / Щипцы для стопорных колец / Щипцы для стопорных кілец / Zégergyűrű fogó / set clește cu spirală / Kleště pro stavěcí kroužky / Segerky vonkajšie rovné / Klešče seger / Replés Ziedams / Sprostgredzenu stangas / Vedrunāpītsads / Клеци Зежер / Kružna Klješta / Kružna klesta / Ασφαλειοταιμιπέδες / Alicates para anillos de asiento / Pinza per anelli elastici / Pinças p. Anéis / Pince pour bagues de retenue / Tang voor dopringen

**TOPEX**

- zewnętrzne proste
- external, straight tip
- зовнішні/прости щипці

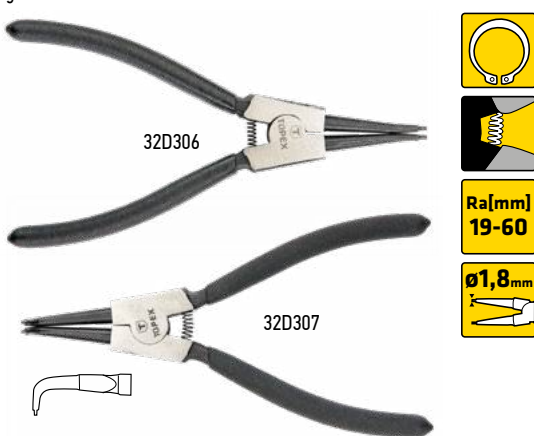

- zewnętrzne wygięte
- external, bent tip
- зовнішні/вигнуті щипці

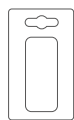

Ref.	L[mm]	Ra[mm]	☒	EAN
32D306	180	19-60	6/60	5902062323064
32D307	175	19-60	6/60	5902062323071



Ra[mm]  
**19-60**

Ø1,8mm

**TOPEX**

- wewnętrzne proste
- internal, straight tip
- внутрішні/прости щипці

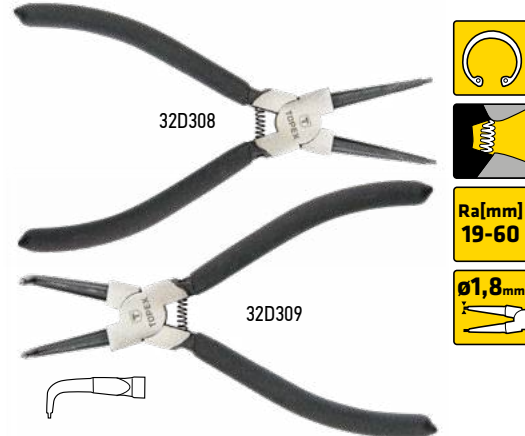

- wewnętrzne wygięte
- internal, bent tip
- внутрішні/вигнуті щипці

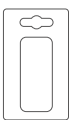

Ref.	L[mm]	Ra[mm]	☒	EAN
32D308	180	19-60	6/60	5902062323088
32D309	175	19-60	6/60	5902062323095



Ra[mm]  
**19-60**

Ø1,8mm

**TOP TOOLS**

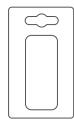

Ref.	L[mm]	☒ [mm]	info	☒	EAN
32D301	150	12-25	internal, straight tip	12/120	5902062010162
32D302	150	12-25	external, bent tip	12/120	5902062010179
32D304	150	12-25	internal, bent tip	12/120	5902062010193

**TOP TOOLS**

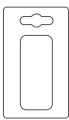

Ref.	L[mm]	☒	EAN
32D320	150	10/60	5902062010643

**x4**

## Obcęgi do gwoździ

Carpenters pincers / Beißzange / Клеци для гвоздів / Harapó fogó / Clește dulgher / Štipací kleště / Cvikačky čelné / Mizarske klešče / Žnyplės vinims / Naglu stangas / Puusepa näpītstangid / Клеци Нерпенден / Stolarska Klješta / Stolarska klesta / Τανάλια Μαραγκού / Tenazas para clavos / Tenaglia da carpentiere / Turqueses p. Pregos / Tenailles à clous / Spijkertang

**NEO TOOLS**

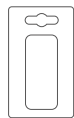

25 years  
GUARANTEE

TÜV Rheinland  
CERTIFIED

CrV  
steel

Ref.	L[mm]	☒	EAN
01-151	180	6/48	5907558411720
01-150	200	6/48	5907558406054

**TOPEX**

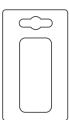

CrV

Ref.	L[mm]	☒	EAN
32D530	180	6/60	5902062325303
32D531	200	6/60	5902062011411

**TOP TOOLS**



Ref.	L[mm]	☒	EAN
32D130	180	6/60	5902062010919
32D131	200	10/60	5902062010216

## Cęgi zbrojarskie

Concretor's nippers / Клеци арматурные / Bewehrungs zange / Кліщі в'язальні / Harapó fogó / Clește fierar / Armovací kleště / Armovacie klešče / Armaturne klešče / Žnyplės armatūrai / Armatūras knaibles / Jūvotslōiketangid / Арматурни клеци / Klješta za rezanje čelične žice / Klešta za armaturu / Τανάλια οικοδόμου / Pinzas de ferrallista / Tenaglia per calcestruzzo / Turques / Pince de ferrailleur / Vlecht tang

**NEO TOOLS**

TÜV Rheinland  
CERTIFIED

CrV  
steel

nickle  
plated

max ø  
4.5 mm

55  
HRC

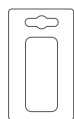

Ref.	L[mm]	☒	EAN
01-165	300	6/36	5907558425550



## Szczypce zaciskowe

Locking pliers / Klemmzange / Клепци зажимные / Плоскозубці обтискні / Patentfogó / Clește fixator / Upinací kleště / Kliešte fixačné univerzálne / Prijemne klešče / Užspaidimo replės / Fiksatorstangas / Lukustustangid / Клепци Чирак / Stop klijesta / Smrt klesta / Πένες - Γκριπ / Tenazas grip / Pinza a scatto dritta / Pinças para grampear / Pince de serrage / Krimptang

**NEO**  
TOOLS

25  
years  
GUARANTEE

TÜV Rheinland  
CERTIFIED

CrV  
steel

CrMo  
steel

**NEO**  
TOOLS

25  
years  
GUARANTEE

TÜV Rheinland  
CERTIFIED

CrV  
steel

CrMo  
steel

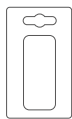

Ref.	L [mm]	Ra [mm]	⊠	EAN
01-216	250	0-47	6/36	5907558409185

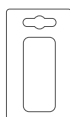

Ref.	L [mm]	Ra [mm]	⊠	EAN
01-217	250	0-45	6/36	5907558409192

**T TOPEX**

CrV

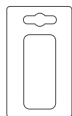

Ref.	L [mm]	Ra [mm]	⊠	EAN
32D856	225	0-40	6/48	5902062011671

**T TOPEX**

CrV

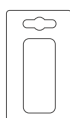

Ref.	L [mm]	Ra [mm]	⊠	EAN
32D857	225	0-55	6/48	5902062011688

**T TOPEX**

CrV

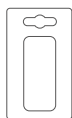

Ref.	L [mm]	Ra [mm]	⊠	EAN
32D855	225	0-40	6/36	5902062011442

**T TOPEX**

CrV

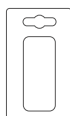

Ref.	L [mm]	Ra [mm]	⊠	EAN
32D456	225	0-50	6/36	5902062010278

**TOP TOOLS**

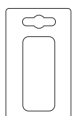

Ref.	L [mm]	⊠	EAN
32D450	180	6/60	5902062010254
32D455	250	6/36	5902062010261

## Szczypce spawalnicze

Locking wrench / Schweißzange / Клепци сварочные / Щипці обтискні / Patentfogó / Clește de blocat / Svářečské kleště / Kliešte fixačné zváračské typ W / Prijemne klešče / Replės su fiksatoriumi / Fiksatorstangas / Lukustusvõti / Клепци Чирак "W" / Stop klijesta / Smrt klesta / Πένες συγκολλητού / Pinzas de presión para soldadura, tipo "W" / Morsetto per saldatura / Pinças p. soldagem / Pince de soudure / Lastang

**T TOPEX**



Ref.	L [mm]	Ra [mm]	⊠	EAN
32D458	225	0-60	5/25	5902062324580

**T TOPEX**

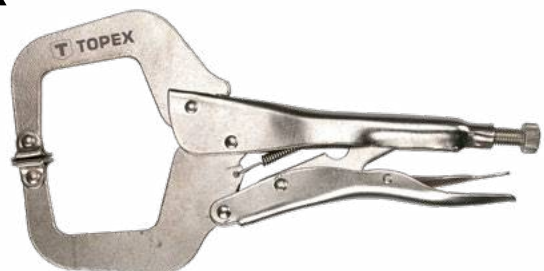

Ref.	L [mm]	Ra [mm]	⊠	EAN
32D459	280	0-40	5/20	5902062324597



## Szczypce blacharskie

Axial grip locking pliers / Klemmzange / Клепцы зажимные / Плоскозубци обтискини / Patentfogó / Clește fixator / Upínací kleště / Kliešte fixačné univerzálne / Prijemne klešče / Užspudimo replés / Fiksátorstangas / Lukustustangid / Клепцы чарак / Stop klijesta / Smrt klesta / Пένσας - γκριπ / Tenzas grip / Pinza griffante / Pinças para grampear / Pince de serrage / Krimptang

**NEO**  
TOOLS

**TYPE**  
**W**  
**195**  
**mm**

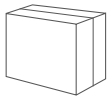

Ref.	info	📦	EAN
11-020	W, max. 25 mm	1/20	5907558445473

**NEO**  
TOOLS

**TYPE**  
**L**  
**195**  
**mm**

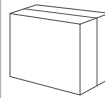

Ref.	info	📦	EAN
11-021	L, max. 57 mm	1/20	5907558445480

**NEO**  
TOOLS

**TYPE**  
**LL**  
**205**  
**mm**

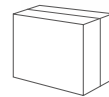

Ref.	info	📦	EAN
11-022	LL, max. 18 mm	1/20	5907558445497

**NEO**  
TOOLS

**TYPE**  
**JJ**  
**230**  
**mm**

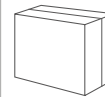

Ref.	info	📦	EAN
11-024	JJ, max. 40 mm	1/20	5907558445510

## Dziurkacz rewolwerowy

Revolving leather punch / Revolverlochmaschine / Дырокол револьверный / Дирокол револьверний / Bőrlukasztó fogó / Cutiț de piele rotativ / Svářečské kleště / Kliešte dierkovacie / Klešče za luknjanje / Sukamasis skylamušis / Saurumstis pistolveida / Pöörlev auguraud naha jaoks / Клепцы Замбу / Klijesta za bušenje rupa / Klesta za busenje rupa / Περιστροφικός ζουμιάς / Alicates sacabocados de revólver / Pinza a fustella per pelle / Perforador / Poinceuse à revolver / Ponsrevolver

**T TOPEX**

**Ra<sub>[mm]</sub>**  
**2,0-4,5**

**TOP TOOLS**

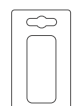

Ref.	L[mm]	Ra [mm]	📦	EAN
32D424	240	2 - 4.5	12/48	5902062324245

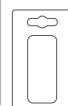

Ref.	L[mm]	Ra [mm]	📦	EAN
32D421	225	2 - 5	10/60	5902062010704





## Szczypce uniwersalne 1000V

Combination pliers / Kombizange / Пассатижи / Пасатижи / Kombinált fogó / Clește universal / Kombinované kleště / Klešte kombinované / Kombinirane klešče / Universalos replės / Plakanknaibles kombinētās / Universaalhantsad / Клещи комбинирани / Kombinirana ključeta / Kombinovana klesta / Πένσα γενικής χρήσης / Alicates universales / Pinza universale 1000V / Pinças universais / Pince universelle / Universele tang

NEO  
TOOLS

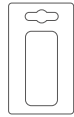

Ref.	L[mm]	☒	EAN
01-220	160	6/60	5907558433043
01-221	180	6/60	5907558433050
01-222	200	6/60	5907558433067

NEO  
TOOLS

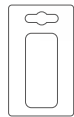

Ref.	L[mm]	☒	EAN
01-240	160	6/48	5907558433364
01-241	180	6/48	5907558433371

TOPEX

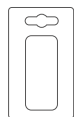

Ref.	L[mm]	☒	EAN
32D510	160	0/10	5902062010797
32D511	180	0/10	5902062010803
32D512	200	0/10	5902062010810

## Szczypce wydłużone wygięte 1000V

Long nose bent pliers / Zange lang, gebogen / Плоскозубцы удлиненные изогнутые / Щипци видовжени, вигнути / Hajlított csőrű fogó / Clește varf ascutit indoit / Kleště prodloužené vyhnuté / Klešte predĺžené vyhnuté / Koničaste klešče - upognjene / Prailgintos replės, lenktos / Izliektas pagarinātas knaibles / Pikkade kõverate otstega näpitsad / Клещи удължени огънати / Izdužena savinuta ključeta / Izdužena uvijena klešta / Μυτοσάιμθο κυρτό / Alicate Teléfono curvo / Pinza universale 1000V / Pinças curvadas prolongadas / Pince allongée coudées / Lange gebogen tang

NEO  
TOOLS

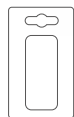

Ref.	L[mm]	☒	EAN
01-227	160	6/60	5907558433111
01-228	180	6/60	5907558433128

## Szczypce wydłużone proste 1000V

Long nose pliers / Gerade Zange, verlängert / Плоскозубцы удлиненные прямые / Плоскозубци з видовженими зубицями / Hosszúcsőrű fogó / Clește ascutit bine / Kleště prodloužené rovné / Klešte špicaté rovné / Koničaste klešče / Replės pailgintos, tiesios / Plakanknaibles pagarinātās taisnās / Pikkmokk-näpitsad / Клещи Чооку / Flah Ključeta / Flah klesta / Μυτοσάιμθο μα μακρά πόμψη / Alicates largos rectos / Pinza a becco lungo 1000V / Pinças retas prolongadas / Pince allongée droite / Lange rechte tang

NEO  
TOOLS

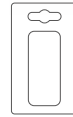

Ref.	L[mm]	☒	EAN
01-223	160	6/60	5907558433074
01-224	180	6/60	5907558433081
01-225	200	6/60	5907558433098

NEO  
TOOLS

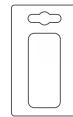

Ref.	L[mm]	☒	EAN
01-242	160	6/48	5907558433388

TOPEX

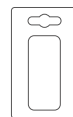

Ref.	L[mm]	☒	EAN
32D513	160	0/10	5902062010827

## Szczypce do rur 1000V

Water pump pliers / Rohrzange / Клещи трубные / Ключи трубні / Vizpumpa fogó / Clește p/u pompa de apă / Kleště na trubky / Hasák / Cevne klešče / Replės vamzdžiams / Rorstangas / Veepumba tangid / Клещи Гагза / Ključeta papige / Klesta papagaj / Γκαζοσάιμθο / Tenazas para tubos / Pinza giratubi 1000V / Pinças p. Tubos / Pince pour tubes / Buistang

NEO  
TOOLS

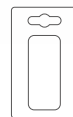

Ref.	L[mm]	☒	EAN
01-232	250	6/36	5907558433166



## Szczypce boczne 1000V

Diagonal cutting pliers / Seitenzange / Бокорезы / Бокорізи / Oldalcspíp fogó / Clește ascuțit diagonal de tăiat sîrmă / Bočni kleště / Cvikačky bočné / Stranske klešče / Šoninés replés / Sänknaibles / Diagonaal-löiketangid / Клеци Резачки / Клієшта свікерце / Klesta poluokrugla / Πλαγιοκόπτες / Alicates diagonales / Tronchese laterale 1000V / Pinças laterais / Pince latérale / Zijtang

NEO  
TOOLS

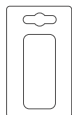

Ref.	L[mm]	Ø [mm]	⊠	EAN
01-525	160	1.5; 2.5	0/36	5907558404340

NEO  
TOOLS

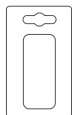

Ref.	L[mm]	⊠	EAN
01-226	160	6/60	5907558433104

NEO  
TOOLS

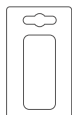

Ref.	L[mm]	⊠	EAN
01-243	160	6/48	5907558433395

NEO  
TOOLS

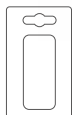

Ref.	L[mm]	⊠	EAN
01-231	180	6/60	5907558433159

NEO  
TOOLS

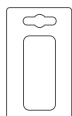

Ref.	L[mm]	⊠	EAN
01-244	180	6/48	5907558433401

TOPEX

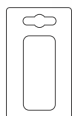

Ref.	L[mm]	⊠	EAN
32D517	160	0/10	5902062010896

## Szczypce do izolacji 1000V

Wire stripper / Isolierungszange / Бокорезы для зачистки / Бокорізи для зачищування / Kábelcsupaszoló / Clește p/înlăturarea izolatoarelor / Kleště na izolaci / Kliešte odizolovacie / Klešče za snemanje izolacije / Replés izolációjai / Кнаibles izoláciái / Кааблитангид / Клеци Загольвачки за монтаж / Klesta za izolaciju / Απογυμνωτές καλωδίων / Alicates pelacables / Pinza spela fili regolabile 1000V / Pinças p. Isolação / Pince à dénuder / Isolietang

NEO  
TOOLS

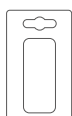

Ref.	L[mm]	Ø [mm <sup>2</sup> ]	⊠	EAN
01-245	160	0.2 - 6.0	6/48	5907558433418

NEO  
TOOLS

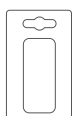

Ref.	L[mm]	Ø [mm <sup>2</sup> ]	⊠	EAN
01-229	160	0.2 - 6.0	6/60	5907558433135



## Szczypce do cięcia kabli 1000V

Cable cutter / Kabelabschneider / Кабелперез / Обрізувач для кабелю / Kábelvágó fogó / Cleste pentru taiat cabluri / Kleště na kabely / Klešte na káble / Nož za rezanje kablov / Kandiklės kabeliui / Kabelu griezējs / Kaablilõikur / Резачна за кабелу / Rezač kablova / Nož za rezanje kablova / Κόφτης καλωδίων / Alicata cortacables / Taglia cavo 1000V / Cortador p. Cabos / Coupe-câbles / Knipper voor kabels

NEO  
TOOLS

25 years GUARANTEE  
CrV steel  
1000V

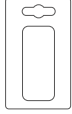

Ref.	L[mm]	⊠	EAN
01-233	160	6/60	5907558433173



## Nóż monterski 1000V

Fitter's knife / Monteurmesser / Нож монтерский / Ніж монтерський / Kábelvágó kés / Cutit pentru cabluri / Nůž montérský / Montérský nůž / Montažni nož / Montuotojo peilis / Montiera nazis / Elektrikunuga / Монтьорски нож / Monterski nož / Monterski nož / Μαχαίρι ηλεκτρολόγου / Cuchillo recto para cables / Coltello per elettricisti / Faca p. montagem / Couteau de monter / Montagernes

NEO  
TOOLS

TÜV Rheinland CERTIFIED  
25 years GUARANTEE  
1000V  
51-53 HRC

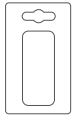

Ref.	L[mm]	L <sub>1</sub> [mm]	⊠	EAN
01-550	195	50	12/72	5907558409239

NEO  
TOOLS

TÜV Rheinland CERTIFIED  
25 years GUARANTEE  
1000V  
51-53 HRC

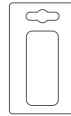

Ref.	L[mm]	L <sub>1</sub> [mm]	⊠	EAN
01-551	190	50	12/72	5907558409246

## Zestaw narzędzi 1000V

Tools set / Werkzeugsatz / Набор инструментов / Набор інструментів / Szerszámkészlet / Set scule de grădini / Sada nářadí / Súprava náradia / Garnitura orodja / Įrankių komplektas / Instrumentu komplekts / Тööriistakomplekt / Гедорє комплект / Set uređaja / Set alata / Συλλογή εργαλείων / Juego de herramientas / Set attrezi 1000V / Kit de ferramentas / Jeu d'outils / Gereedschapsset

NEO  
TOOLS

25 years GUARANTEE  
CrV steel  
1000V  
x4



180mm



160mm



200mm



160mm  
0.2-6.0mm<sup>2</sup>



Ref.	⊠	EAN
01-236	0/8	5907558433203

NEO  
TOOLS

25 years GUARANTEE  
CrV steel  
S2 steel  
1000V  
x7

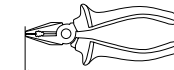

160mm

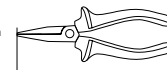

160mm



160mm

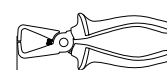

160mm  
0.2-6.0mm<sup>2</sup>



1.0 x 5.5 x 125mm

PH2 x 6 x 100mm

Ref.	⊠	EAN
01-235	0/6	5907558433197



## Zestaw narzędzi 1000V

Tools set / Werkzeugsatz / Набор инструментов / Набор інструментів / Szerszámkészlet / Set scule de grădini / Sada nářadí / Súprava nářadí / Garnitura orodja / Įrankių kompleksas / Instrumentu komplekts / Тööriistakomplekt / Тодор комплект / Set uređaja / Set alata / Συλλογή εργαλείων / Juego de herramientas / Set attrezzi 1000V / Kit de ferramentas / Jeu d'outils / Gereedschapsset

**NEO**  
TOOLS

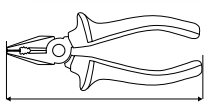

180mm

5.5x125 mm PH1x80

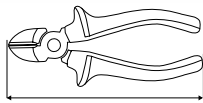

160mm

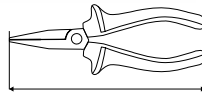

160mm

Ref. 01-237 EAN 5907558433210

**NEO**  
TOOLS

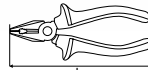

160mm

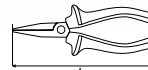

160mm

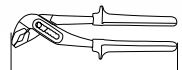

250mm

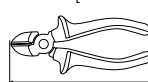

160mm

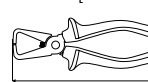

160mm

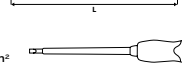

0.2-6.0mm<sup>2</sup>

1.0 x 5.5 x 125 mm; 0.8 x 4 x 100 mm; 1.0 x 6.5 x 150 mm  
PH0 x 3 x 60 mm; PH2 x 6 x 100 mm;  
PH1 x 4.5 x 80 mm; PH3 x 8 x 150 mm

Ref. 01-234 EAN 5907558433180

## Ściągacz izolacji

Wire stripper / Abziehvorrichtung für Isolierung / Съемник изоляции / Знімач ізоляції / Kábelcsupaszoló / Dispozitiv de scos izolatie / Stahovač izolace / Kliešte na stahovanie izolácie / Snemalnik izolacije / Izolācijas nuemimo replēs / Izolācijas porēmejs / Isolatsioonitõmmits / Изолирующая снуба / Skidač izolacije / Skidač izolacije / Εργαλείο για αφαίρεση μόνωσης / Alicates pelacables / Spelafli universale / Ponta de aperto de izolação / Dénudeur d'isolation / Trekker voor isolatie

**NEO**  
TOOLS

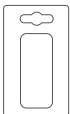

Ref. 01-524 L[mm] 125 EAN 5907558415643

**NEO**  
TOOLS

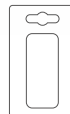

Ref. 01-400 L[mm] 170 EAN 5907558449617

**TOPEX**

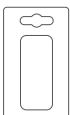

Ref. 32D405 L[mm] 165 EAN 5902062324054

**TOPEX**

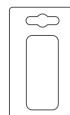

Ref. 32D810 L[mm] 130 EAN 5902062328106



## Automatyczny ściągacz izolacji

Automatic wire stripper / Automat. Abziehzange / Съемник изоляции автоматический / Автоматичний стягувач ізоляції / Kábelcsupaszoló automata / Clește automatic p/u extragerea izolației / Automatické stahovadlo izolace / Kliešte odizolovacie automatické / Kliešče za snemanje izolacije / Automatinis izoliacijos nuimtuvas / Stangas izolācijas noņemšanai automātiskās / Autoaatsed kaablitingid / Клеци заголавачки / Kliešta za izolaciju / Αυτόματος απογυμνωτής καλωδίων / Alicates pelacables automáticos / Spelaflii automatico / Aparelho automático de remover isolação / Dénudeuse d'isolation automatique / Automatisch draadstriptang

**NEO**  
TOOLS



Ref.	L[mm]	⊠	EAN
01-519	195	10/60	5907558415599

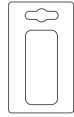

**NEO**  
TOOLS



Ref.	L[mm]	⊠	EAN
01-520	170	8/48	5907558415605

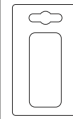

**NEO**  
TOOLS



Ref.	L[mm]	⊠	EAN
01-538	175	8/48	5907558484571

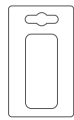

Ref.	L[mm]	⊠	EAN
01-534	180	10/40	590755843935

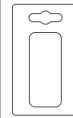

**NEO**  
TOOLS



Ref.	L[mm]	⊠	EAN
01-500	205	10/60	5907558403190

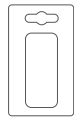

**NEO**  
TOOLS



Ref.	L[mm]	⊠	EAN
01-540	200	10/40	5907558454994

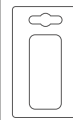

**NEO**  
TOOLS



Ref.	L[mm]	⊠	EAN
01-542	205	0/10	5907558485493



**TOPEX**



Ref.	L[mm]	⊠	EAN
32D806	210	6/60	5902062011374

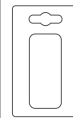

**TOPEX**

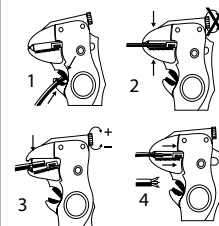

Ref.	L[mm]	⊠	EAN
32D406	175	10/50	5902062324061



## Szczypce do zaciskania końcówek

Crimping pliers / Feinzunge, zur Verklemmung der Endungen / Клещи для обжима кабельных наконечников / Щипці кабельні, затисні / Kábelsaru fogó / Cleste pentru sertizat/conectori / Kleště na svírání koncovek / Kliešte na koncovky / Kliešče za stiskanje konic / Replès, antgaliñ užspaudimui / Knaibles kabelu užgaļu saspiēšanai / Otsakinnitusnõpitsad / Клещи за притискане на краища на кабелу / Klješta za pritiskanje nastavaka / Klešta za pričvršćivanje krajeva / Πένσα ακροδεκτών / Pinzas de presión para puntas / Pinza per terminali / Pinças p. Grampear pontas / Pince universelle de serrage d'embouts / Tang voor eindstukken

NEO  
TOOLS

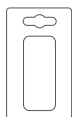

Ref.	L[mm]	Info	⊠	EAN
01-506	220	0,5-16 mm <sup>2</sup> (22-6 AWG)	12/24	5907558409994

NEO  
TOOLS

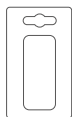

Ref.	L[mm]	⊠	EAN
01-507	170	5/20	5907558414394

NEO  
TOOLS

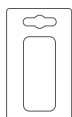

Ref.	L[mm]	⊠	EAN
01-501	195	8/48	5907558403206

NEO  
TOOLS

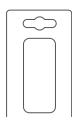

Ref.	L[mm]	⊠	EAN
01-532	140	20/80	5907558432367
01-533	140	20/80	5907558432374

NEO  
TOOLS

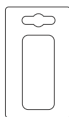

Ref.	L[mm]	⊠	EAN
01-536	210	0/20	5907558439298

NEO  
TOOLS

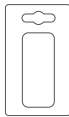

Ref.	L[mm]	⊠	EAN
01-502	250	6/36	5907558408454

NEO  
TOOLS

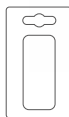

Ref.	L[mm]	⊠	EAN
01-539	230		5907558485479

NEO  
TOOLS



Ref.	L[mm]	⊠	EAN
01-537	220	0/5	5907558439304



## Szczypce do zaciskania końcówek

Crimping pliers / Feinzunge, zur Verklebung der Endungen / Клещи для обжима кабельных наконечников / Щипці кабельні, затисні / Kábelsaru fogó / Cleste pentru sertizat/conectori / Kleště na svírání koncovek / Kliešte na koncovky / Kliešče za stiskanje konic / Replės, antgalių užspaudimui / Knaibles kabelų uzgalo spasiėsanai / Otsakinnitusnāpitsad / Клеци за прутискане на краица на кабелу / Klješta za pritiskanje nastavaka / Klešta za pričvršćivanje krajeva / Πένσα ακροδεκτών / Pinzas de presión para puntas / Pinza per terminali / Pinças p. Grampear pontas / Pince universelle de serrage d'embouts / Tang voor eindstukken

**NEO**  
TOOLS

25  
years  
GUARANTEE

TÜV Rheinland  
CERTIFIED



52-57  
HRC

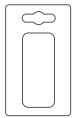

Ref.	L[mm]	⊠	EAN
01-503	250	6/36	5907558403213

**NEO**  
TOOLS

25  
years  
GUARANTEE

PV  
PHOTO  
VOLTAIC

MC4  
connector

2.5 / 4 / 6  
mm<sup>2</sup>

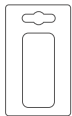

Positioner w zestawie  
Positioner included  
Позиційник включений

Ref.	L[mm]	⊠	EAN
01-555	270	10/20	5902062063427

**NEO**  
TOOLS

25  
years  
GUARANTEE

EASY  
SIZE  
CHANGING

SOFT  
HANDLE

6-50  
mm<sup>2</sup>

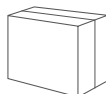
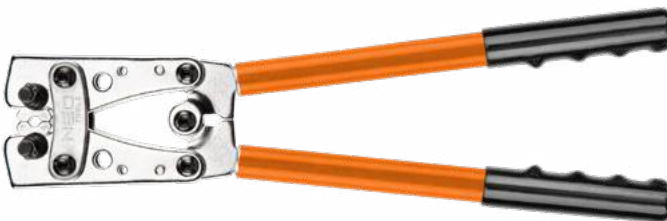

Ref.	L[mm]	⊠	EAN
01-530	390	0/10	5907558432343

**NEO**  
TOOLS

25  
years  
GUARANTEE

EASY  
SIZE  
CHANGING

SOFT  
HANDLE

10-120  
mm<sup>2</sup>

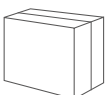

Ref.	L[mm]	⊠	EAN
01-531	610	0/5	5907558432350

**TOPEX**



12x  
6P

12x  
8P

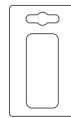

Ref.	L[mm]	⊠	EAN
32D408	185	10/30	5902062324085

**TOPEX**



4P  
6P 8P

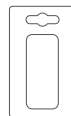

Ref.	L[mm]	⊠	EAN
32D409	195	0/50	5902062324092

**TOPEX**

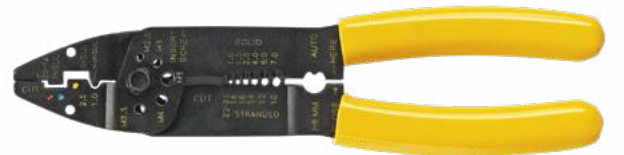

1,0÷7mm<sup>2</sup>

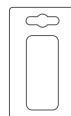

Ref.	L[mm]	∅ [mm <sup>2</sup> ]	⊠	EAN
32D404	210	1.0 - 7.0	12/72	5902062324047

**TOPEX**



0,75÷6mm<sup>2</sup>

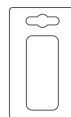

Ref.	L[mm]	∅ [mm <sup>2</sup> ]	⊠	EAN
32D410	230	0.75 - 6.0	0/60	5902062324108

**TOP TOOLS**

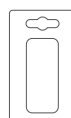

Ref.	L[mm]	⊠	EAN
32D402	200	0/100	5902062010308



## Praska ręczna hydrauliczna do końcówek elektrycznych

Hydraulic hand press for electric bits / Hydraulische Handpresse für Elektroböhrer / Γυδραυλική χειρωνακική μηχανή για ηλεκτρικά βιτάκια / Пресс для электросверл / Прес гидравлический ручной для электрических долбит / Hidraulikus kézi sajító elektromos bitekhez / Presă hidraulică manuală pentru biți electrice / Hydraulický ruční lis pro elektrické bity / Hydraulický ručný lis pre elektrické bity / Hidravlična ročna stiskalnica za električne svedre / Hidraulinis rankinis presas elektriniams gražtams / Hidrauliskā rokas prese elektriskajiem bitiēm / Χειρωνακική ρύχνα πρέσα για ηλεκτρικές βιτάκια / Υδραυλική πρέσα χειρός για ηλεκτρικά εργαλεία / Pressa manuale idraulica per punte elettriche / Prensa manual hidráulica para brocas eléctricas / Prensa manual hidráulica para brocas eléctricas / Presse hydraulique à main pour mèches électriques / Hydraulische handpers voor elektrische bits

**NEO**  
TOOLS



Ref.	[mm <sup>2</sup> ]	⊠	EAN
01-543	16-300	0/4	5907558485523

## Νοήγες do kabli i izolacji

Cable and insulation cutter / Schere für Kabel und Isolierung / Ножницы для кабеля и изолирующей оболочки / Ножницы по кабелю и изоляции / Kábelvágóolló / Foarfeca taiat/dezizolat cabluri / Nůžky na kabely a na izolaci / Nožnice na káble a izolácie / Škarje za kable in izolacijo / Žirkles kabeliui ir izoliacijai / Šķēres kabelēm un izolācijai / Kaabli- ja isolatsioonikäärid / Ножницы за кабелю и изоляция / Škare za kablove i izolaciju / Makaze za kablove i izolaciju / Ψαλίδι καλωδίων και μόνωσης / Tijeras de electricista / Forbice da elettricista / Tesoura para cabos e isolação / Cisaille à câbles et isolation / Schaar voor kabels en isolatie

**NEO**  
TOOLS

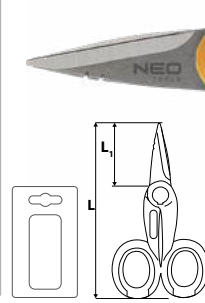

Ref.	L[mm]	L <sub>1</sub> [mm]	⊠	EAN
01-511	140	45	12/72	5907558405378



## Obcinak do kabli

Cable cutter / Kabelabschneider / Кабелорез / Обрезывач для кабелю / Kábelvágó / Cleste pentru taiat cabluri / Klešče na kabely / Kliešte na káble / Nož za rezanje kablov / Kandikles kabeliui / Kabeļu griezējs / Kaablilõikur / Резачка за кабелю / Rezač kablova / Nož za rezanje kablova / Κόφτης καλωδίων / Alicate cortacables / Cesoie per cavi / Cortador p. Cabos / Coupe-câbles / Knipper voor kabels

**NEO**  
TOOLS



Ref.	L[mm]	⊠	EAN
01-510	185	12/72	5907558405361

**NEO**  
TOOLS



Ref.	L[mm]	⊠	EAN
01-401	400	5/10	5907558449624

**NEO**  
TOOLS



Ref.	L[mm]	max ø [mm <sup>2</sup> ]	⊠	EAN
01-516	250	325	10/30	5907558408522

**NEO**  
TOOLS



Ref.	L[mm]	max ø [mm <sup>2</sup> ]	⊠	EAN
01-517	440	20	0/12	5907558408515

**NEO**  
TOOLS



Ref.	L[mm]	max ø [mm <sup>2</sup> ]	⊠	EAN
01-513	160	10	6/48	5907558408485
01-514	200	13	6/48	5907558408492
01-515	235	25	6/36	5907558408508

## Obcinak do drutów

Cable wire cutter / Abschneider für Draht / Кабелорез / Обрезывач до дротю / Drótvágó fogó / Cleste taiat cabluri / Klešče na drát / Kliešte cvikacie na káble a ocelové laná / Nož za žice in jeklenice / Kandikles vielai ir plieniniam lūnei / Stieplu vai tērauda auklu griezējs / Traadi- ja terasjuhtmelõikur / Резачка за метални жица / Rezač za žice i čelične sajle / Nož za žicu i čeličnu užad / Κόφτης καλωδίων / Alicate para cortar cable trenzado / Troncatrice per filo / Cortador de arames / Coupe-fils / Knipper voor draad

**NEO**  
TOOLS



Ref.	L[mm]	⊠	EAN
01-518	210	6/48	5907558413007





## Obcinak do drutów i linek stalowych

Cable and steel wire cutter / Abschneider für Draht und Stahlseilen / Кабелерез / Обрізувач до дроту і тросів / Drótvágó fogó / Cleste taiat cabluri / Kleště na drát a na ocelovú lanku / Kliešte cvikacie na káble a ocelové laná / Nož za žice in jeklenice / Kandiklé vielai ir plieniniam lynei / Stieplu vai tērauda auklu griežējs / Traadija terasjuhtmelõikur / Резачка за тел у стоманени вѣжета / Rezač za žice i čelične sajle / Nož za žicu i čeličnu užad / Κόφτης καλωδίων / Alicata para cortar cable trenzado / Troncatrice per cavi e fili in acciaio / Cortador p. Arames e cabos de aço / Cisaille à fils et câbles d'acier / Knipper voor draad en staalkabels

**NEO**  
TOOLS

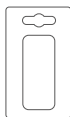

Ref.	L[mm]	⊠	EAN
01-512	190	10/60	5907558410891

## Pinceta prosta

Tweezer fine tip straight / Gerade Pinzette / Пинцет прямой / Пинцет прямиий / Műszeréscsipesz / Pensetă subțire dreaptă / Pinzeta rovná / Pinzeta špicatá / Pinceta / Tiesus pincetas / Pincete taisyna / Harilikud pintsetid / Пинцету / Pinceta / Pinceta / Iala тапимба / Pinza recta / Pinzetta / Pinças retas / Pincette droite / Strakke pincet

**TOPEX**

Hardened

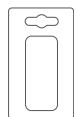

Ref.	L[mm]	⊠	EAN
32D425	135	12/288	5902062324252

## Pincety

Tweezer set / Pinzetten / Пинцеты / Пинцети, набір / Műszeréscsipesz készlet / set pensete / Pinzety / Pinzety, súprava / Garnitura pincet / Pincetas / Pincešu komplekts / Pintsetide komplekt / Pinceta set / Συλλογή λαβίδων / Pinzas / Set pinzette / Pinças / Pincettes / Pincetten

**TOP TOOLS**

x4

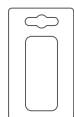

Ref.	L[mm]	⊠	EAN
32D423	120	12/240	5902062140371

## Ściągacz izolacji fotowoltaika

Photovoltaic wire stripper / Photovoltaik-Isolationsabstreifer / Інструмент для снятия ізоляції фотовольтаїки / Інструмент для зняття ізоляції фотовольтаїки / Blankoló napelemekhez / Cleste de dezizolat cabluri fotovoltaice / Stahováč izolace fotovoltaiika / Stahovák izolácie fotovoltaiiky / Odstraňovač izolácie fotovoltaiika / Izolācijas traukturuvai fotovoltaiika / Izolācijas noņēmējs saules baterijām / Fotogalvaanika isolatsioonitõmmits / Клещи за сваляне на изолация за фотоволтаїку / Skidač izolacije fotonaponski sustav / Skidač izolacije fotovoltaiike / Φωτοβολταϊκός απογυμνωτής απομόνωσης / Extractor del aislamiento del sistema fotovoltaiico / Sprogliatore di isolamento per il fotovoltaiico / Extrator do isolamento do sistema fotovoltaiico / Extracteur d'isolant système photovoltaiique / Fotovoltaiische isolatiestripper / Sleutels voor fotovoltaiische cellen

**NEO**  
TOOLS



Ref.	L[mm]	⊠	EAN
01-557	200	10/20	5907558460216

## Zestaw narzędzi do fotowoltaiki

Photovoltaic service tool kit / Photovoltaik-Werkzeugset / Набор инструментов для фотовольтаїки / Набор інструментів для фотовольтаїки / Szerszámkészlet napelemekhez / Set de scule pentru sisteme fotovoltaiice / Sada nářadí pro fotovoltaiiku / Sada nářadia na fotovoltaiiku / Komplet orodja za fotovoltaiiku / Fotovoltaiikių įrankių rinkinys / Instrumentu saules baterijām komplekts / Fotogalvaanika tööriistakomplekt / Komplet instrumentu za fotovoltaiiku / Set alata za fotonaponske sustave / Komplet alata za fotovoltaiiku / Σετ εργαλείων για φωτοβολταϊκά / Kit de herramientas para el sistema fotovoltaiico / Kit di attrezzi per il fotovoltaiico / Conjunto de ferramentas para o sistema fotovoltaiico / Kit outils système photovoltaiique / Gereedschapskit voor fotovoltaiische cellen

**NEO**  
TOOLS



01-555 - 270 mm  
01-557 - 200 mm  
01-558 - 118 mm  
01-513 - 160 mm

Ref.	⊠	EAN
01-559	0/5	5907558460209

## Szczypce do zaciskania konektorów fotowoltaicznych

Crimping pliers for photovoltaic connectors / Zange für das Pressen der photovoltaischen Konnektoren / Клещи для опрессовки фотовольтаических коннекторов / Кліщі для обпресування фотовольтаїчних коннекторів / Krimpelő fogók napelem-konnektorokhoz / Cleste pentru sertizarea conectorilor fotovoltaiici / Kleště na lisování fotovoltaiických konektorů / Lisovacie kliešte na fotovoltaiické konektory / Klešče za stiskanje fotovoltaiičnih konektorjev / Užspaudimo replės fotovoltinėms jungtims / Knaibles saules bateriju savienotāju saspišana / Presstangid fotogalvaaniliste pistikute jaoks / Клещи за пресоване на фотоволтаїчни коннектору / Klijesta za stezanje fotonaponskih konektora / Kleme za stiskanje fotovoltaiičnih konektora / Πένσα πιέσκωψ για φωτοβολταϊκούς συνδετήρες / Crimpadora para conectores fotovoltaiicos / Pinza di bloccaggio dei connettori fotovoltaiici / Alicates de crimpagem de conetores fotovoltaiicos / Pinceaux pour serrage de connecteurs photovoltaiiques / Krimptang voor fotovoltaiische connectoren /

**NEO**  
TOOLS



Ref.	⊠	EAN
01-556	10/40	5907558460230

## Klucze fotowoltaika

Photovoltaic wrenches / Photovoltaikschlüssel / Фотовольтаические ключи / Фотовольтаїчні ключі / Kulcsok napelemekhez / Chei pentru sisteme fotovoltaiice / Klíče fotovoltaiika / Fotovoltaiické klíče / Klijūvi fotovoltaiika / Raktai fotovoltaiika / Atslēgas saules bateriju savienotājiem / Fotogalvaanika vītmed / Ключове за фотоволтаїку / Klijūcevi fotonaponski sustav / Klijūcevi fotovoltaiika / Φωτοβολταϊκά κλειδιά / Llaves para el sistema fotovoltaiico / Chiavi fotovoltaiica / Chaves para o sistema fotovoltaiico / Clés système photovoltaiique / Sleutels voor fotovoltaiische cellen

**NEO**  
TOOLS

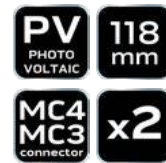

Ref.	L[mm]	⊠	EAN
01-558	118	15/60	5907558460223



## Miernik elektroniczny

Universal multimeter / Elektronikkessgerät / Мультиметр цифровой / Тестер универсальный / Multiméter univerzális / Multimetro universal / Elektronický měřicí přístroj / Univerzálny multimeter / Elektronski multimeter / Universalis el. matuoklis / Multimetr universāls / Universaalne multimeeter / Mynmuem / Univerzalni multimetar / Ηλεκτρονικός μετρητής γενικής χρήσης / Multimetro digital / Misuratore universale / Medidor electrónico / Appareil de mesure électronique / Elektronisch meter

**NEO**  
TOOLS

V DC 0-300 V AC 0-300 A DC 0-10 A AC 0-10 Ω 0-20M 20n-1000μ T °C -20-1000

hFE LCD 1999 Auto Range Data hold function

CAT III 300V Nylon bag

x3 AAA



Ref. 94-001 EAN 0/26 5907558409154

## TOPEX



V DC 0-300 V AC 0-300 A DC 0-10

Ω 0-2M

BATT 1.5/9V LCD 1999

CAT III 300V 9V



Ref. 94W104 EAN 25/50 5902062503510

## TOPEX



V DC 0-300 V AC 0-300 A DC 0-10

A AC 0-10 BATT 1.5/9V

Ω 0-20M

CAT III 300V 9V



Ref. 94W105 EAN 0/30 5902062503527

## Miernik cęgowy

Digital clamp meter / Messgerät / Клещи электроизмерительные / Кліщі струмовимірювальні / Multiméter digitális / Clește de măsurat / Klešťový měřicí přístroj / Kliešťový merací prístroj / Tokovne klešče / Matavimo replės / Strāvas aizsargknaibles / Mēģētangid / Електроизмерительни клещи / Mjerač za klijesta / Univerzalni multimetar / Αμπεροαμπίλα / Pinza ampimétrica / Misuratore di voltaggio digitale / Medidor de alicates / Appareil de mesure électrique à pince / Stroomtang

**NEO**  
TOOLS

V DC 0-600 V AC 0-600 A AC 0-300 Ω 0-20M T °C -20-1000 Data hold function

Auto Range LCD 1999

CAT II 600V x3 AAA



Ref. 94-002 EAN 0/20 5907558409161

## Miernik cyfrowy

Digital meter / Digitales Messgerät / Цифровой счетчик / Цифровый лчильник / Digitális műszer / Multimetro digital / Digitální měřidlo / Digitálne meradlo / Digitalni števec / Skaitmeninis matuoklis / Digitālais skaitītājs / Digitaalne mōddlo / Цифровое измерение уред / Digitalno mjerilo / Digitalni merac / ψηφιακό πολόμετρο / Medidor digital / Misuratore digitale / Medidor digital / Compteur numérique / Digitale meter

**NEO**  
TOOLS

AC 600V DC 600V Ω 0.1-60M NCV measurement

Live NCV room temperature 10Hz-8MHz true RMS Data hold function

LCD 5999 Cat II 600V touch screen FLASHLIGHT AUTO recognition

139x68x18mm multicolor display nylon bag 175g 2x AAA not included



Ref. 94-004 EAN 0/80 5907558469523

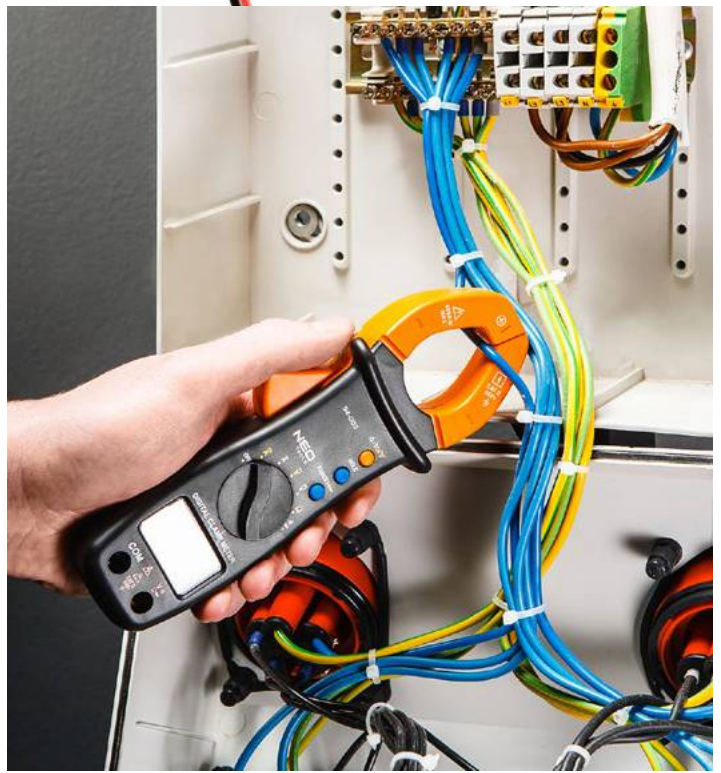

**NEO**  
TOOLS

V DC 0-600 V AC 0-600 A DC 0-600 A AC 0-600 Ω 0-40M Auto Range

LCD 3999 Synthetic leather bag

Data hold function CAT II 600V

x2 AAA



Ref. 94-003 EAN 0/26 5907558407662



## Szczypce do rur

Water pump pliers / Rohrzange / Клепцы трубные / Кліпцы трубні / Vízpumpa fogó / clește p/u pompa de apă / Kleště na trubky / Hasák / Cevne klešče / Replès vamzdziams / Rorstangas / Veepumba tangid / Клепцу Гапца / Klijesta papige / Klesta papragaj / Γκαζοτράνα / Tenazas para tubos / Pinza regolabile da idraulico / Pinças p. Tubos / Pince pour tubes / Buistang

**NEO**  
TOOLS

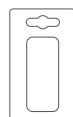
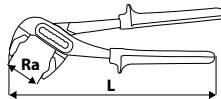

Ref.	L[mm]	Ra[mm]	⊠	EAN
01-202	250	0-36	6/48	5907558434613

**NEO**  
TOOLS

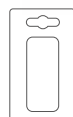
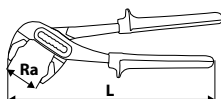

Ref.	L[mm]	Ra[mm]	⊠	EAN
01-200	240	0-31	6/48	5907558434606
01-203	300	0-46	6/24	5907558434620

**NEO**  
TOOLS

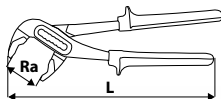

Ref.	L[mm]	Ra[mm]	⊠	EAN
02-435	240	0-52	6/60	5907558464634
02-436	300	0-60	6/36	5907558464641

**T TOPEX**

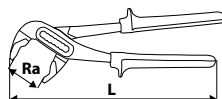

Ref.	L[mm]	Ra[mm]	⊠	EAN
34D512	250	0-35	10/60	5902062345127
34D513	300	0-40	5/40	5902062345134

**TOP TOOLS**



Ref.	L[mm]	Ra[mm]	⊠	EAN
34D020	250	0-40	6/48	5902062010131

**NEO**  
TOOLS

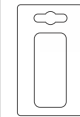
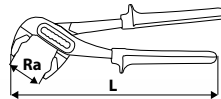

Ref.	L[mm]	Ra[mm]	⊠	EAN
01-204	250	0-42	6/48	5907558412994

**NEO**  
TOOLS

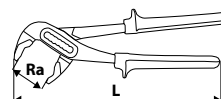

Ref.	L[mm]	Ra[mm]	⊠	EAN
02-401	250	10-45	6/48	5907558462913

**NEO**  
TOOLS

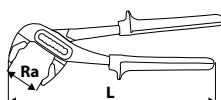

Ref.	L[mm]	Ra[mm]	⊠	EAN
02-412	250	0-38	6/60	5907558463026
02-413	300	0-45	6/48	5907558463033

**TOP TOOLS**



Ref.	L[mm]	Ra[mm]	⊠	EAN
34D010	250	0-36,8	6/60	5902062010667

## Szczypce do armatury

Pliers for armature / Zange für Anker / Плоскогубцы для арматуры / Плоскогубци для арматуры / Fogó armatúrához / Clește pentru armătură / Kleště na armaturu / Klešče za armaturo / Replès armatūrai / Knaibles armatūrai / Tangid armatuuirile / Клепцу за арматура / Klešta za armaturu / Клепца за арматура / Πένσα για σπλισμό / Alicates para inducido / Pinze per armature / Alicates para armadura / Pince pour armature / Tangen voor anker

**NEO**  
TOOLS

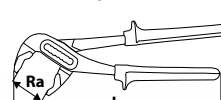

Ref.	L[mm]	Ra[mm]	⊠	EAN
02-441	250	0-42	6/60	5907558464672



## Klucz do rur typ „S”

S-type pipe wrench / Rohrschlüssel Typ "S" / Ключ трубный S-образный / Ключ трубный, тип «S» / Svédfogó / Cheie reglabila pentru țevi, tip "S" / Klešiče trubkové „S” / Ključ na rúry typ „S” / Ključ za cevi tipa „S” / Raktas „S” tipo vamzdžiams / S-tipo sauruļu atslēga / S-tüüpi toruvõti / Тръбен ключ тип "S" / Ključ za cijevi tip "S" / Ključ za cevi tipa "S" / Σαληνοκάβουρας τύπου S / Llave para tubos modelo sueco / Giratubi tipo "S" / Chave p. tubos tipo "S" / Clef pour tubes type "S" / Sleutel voor buizen type "S"

NEO TOOLS

CrV steel S TYPE

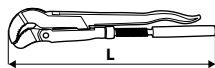

Ref.	L[mm]	Ra [mm/"]	m[kg]	☒	EAN
02-420	320	40/1	0,9	0/30	5907558463095
02-421	420	55/1.5	1,5	0/16	5907558463101
02-422	530	67/2	2,4	0/10	5907558463118

NEO TOOLS

25 years GUARANTEE TÜV Rheinland CERTIFIED CrV steel DIN 5234

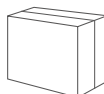
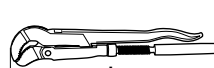

Ref.	L[mm]	Ra [mm/"]	m[kg]	☒	EAN
02-120	235	30/0.5	0,4	0/48	5907558408645
02-121	330	40/1	0,9	0/24	5907558404067
02-122	425	55/1.5	1,5	0/12	5907558404074
02-123	535	67/2	2,4	2/8	5907558404081
02-124	650	103/3	4,2	0/4	5907558405996

TOPEX

CrV S TYPE



Ref.	L [mm]	Ra [mm/"]	☒ [kg]	☒	EAN
34D701	330	40/1.0	0.78	0/30	5902062080851
34D702	420	55/1.5	1.24	1/16	5902062080868
34D703	530	67/2.0	2.33	0/10	5902062080875

TOP TOOLS

Type S



Ref.	Ra [mm/"]	☒	EAN
34D130	35/1.0	10/36	5902062081094
34D131	46/1.5	0/18	5902062081100

## Klucz do rur typ 45

Pipe wrench type 45 / Rohrschlüssel Typ "45" / Ключ трубный тип "45" / Ключ трубный, тип «45» / Svédfogó / Cheie reglabila pentru țevi, tip "45" / Klešiče trubkové 45 st. / Ključ na rúry typ „45” / Ključ za cevi tipa „45” / Raktas „45” tipo vamzdžiams / 45 tipa sauruļu atslēga / 45-tüüpi toruvõti / Тръбен ключ тип "45" / Ključ za cijevi tip "45" / Ključ za cevi tipa "45" / Σαληνοκάβουρας τύπου 45 / Llave para tubos modelo sueco "45" forma de S / Giratubi / Chave p. tubos tipo "45" / Clef pour tubes type "45" / Sleutel voor buizen type "45"

NEO TOOLS

CrV steel 45 TYPE

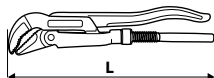

Ref.	L[mm]	Ra [mm/"]	m[kg]	☒	EAN
02-426	330	40/1	0,8	0/30	5907558463156
02-427	420	55/1.5	1,4	0/16	5907558463163
02-428	530	67/2	2,3	0/10	5907558463170

NEO TOOLS

25 years GUARANTEE TÜV Rheinland CERTIFIED CrV steel DIN 5234

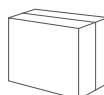
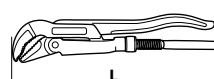

Ref.	L[mm]	Ra [mm/"]	m[kg]	☒	EAN
02-126	330	40/1	0,8	6/24	5907558406016
02-127	415	55/1.5	1,4	4/16	5907558406023
02-128	535	67/2	2,3	0/12	5907558406030

TOPEX

CrV 45°



Ref.	L [mm]	Ra [mm/"]	☒ [kg]	☒	EAN
34D761	330	40/1.0	0.66	0/30	5902062347619
34D762	420	55/1.5	1.05	1/16	5902062347626

TOP TOOLS

45°



Ref.	Ra [mm/"]	☒	EAN
34D110	35/1.0	0/30	5902062080042
34D111	46/1.5	10/20	5902062080059
34D112	65/2.0	6/12	5902062080066



## Klucz do rur typ „90”

Pipe wrench type 90 / Rohrschlüssel Typ „90” / Ключ трубный тип „90” / Ключ трубный, тип «90» / Svédfogó 90° / Cheie reglabila pentru tevi, tip „90” / Kleště trubkové 90 st. / Klíč na rúry typ „90” / Ključ za cevi tipa „90” / Raktas vamzdžiams „90” tipo / 90 tipa caurulu atslēga / 90-tiipi toruvõti / Тръбен ключ тип „90” / Ključ za cijevi tip „90” / Ključ za cevi tipa „90” / Σωληνοκάβουρας τύπου 90 / Llave para tubos modelo sueco “90” / Giratubi / Chave p. tubos tipo “90” / Clef pour tubes type “90” / Sleutel voor buizen type “90”

NEO TOOLS

25 years  
GUARANTEE

TUV Rheinland  
CERTIFIED

CrV  
steel

DIN  
5234

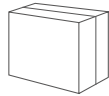
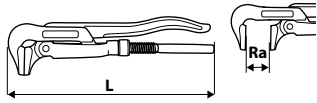

Ref.	L[mm]	Ra [mm/"]	m[kg]	☒	EAN
02-130	320	40/1	0,8	6/24	5907558411478
02-131	425	55/1.5	1,3	4/16	5907558411485
02-132	560	67/2	2,2	2/8	5907558411492

NEO TOOLS

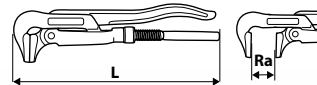

CrV  
steel

90  
TYPE



Ref.	L[mm]	Ra [mm/"]	m[kg]	☒	EAN
02-423	330	40/1	0,8	0/30	5907558463125
02-424	420	55/1.5	1,3	0/16	5907558463132
02-425	530	67/2	2,2	0/10	5907558463149

TOP TOOLS



90°

Ref.	Ra [mm/"]	☒	EAN
34D120	35/1.0	12/36	5902062081063
34D121	46/1.5	9/18	5902062081070
34D122	65/2.0	6/12	5902062081087

## Klucz do rur stillson

Stillson pipe wrench / Rohrschlüssel stillson / Ключ трубный stillson / Ключ трубный «Stillson» / Csőfogó „Stillson” / Cheie reglabila pentru tevi / Kleště trubkové Stillson / Klíč na rúry stillson / Ključ za cevi stillson / Raktas vamzdžiams „Stillson” / Caurulu atslēga / Stillson-toruvõti / Тръбен ключ stillson / Ključ za cijevi stillson / Ključ za cevi stillson / Σωληνοκάβουρας τύπου Stillson / Llave stillson / Giratubi Stillson / Chave p. Tubos stillson / Clef pour tubes stillson / Sleutel voor stillsonbuizen

NEO TOOLS

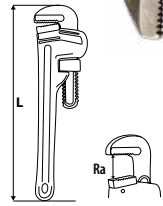

Ref.	L [mm]	Ra [mm/"]	☒ [kg]	☒	EAN
02-415	250	50/1.5	0.62	6/36	5907558463040
02-416	300	70/2.0	0.94	0/24	5907558463057
02-417	350	80/2.0	1.25	0/18	5907558463064
02-418	450	90/2.5	1.79	6/12	5907558463071
02-419	600	100/3.0	2.73	4/8	5907558463088

NEO TOOLS

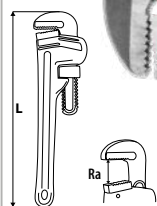

Ref.	L[mm]	Ra ["]	☒	EAN
02-106	300/12"	1 3/4"	0/24	5907558434583
02-107	350/14"	2"	0/24	5907558434590

NEO TOOLS

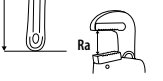

Ref.	L[mm]	Ra ["]	☒	EAN
02-111	450	1 3/4"	0/24	5907558435856
02-112	600	2"	0/24	5907558435863

TOPEX

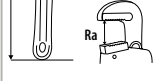

Ref.	L [mm]	Ra [mm/"]	☒	EAN
34D614	350	80/2.0	6/24	5902062080974
34D615	400	90/2.5	4/12	5902062080981

## Klucz do śrubunków z grzechotką

Pipe union ratchet wrench / Stufenschlüssel mit Ratsche / Ключ для разъемных соединений с трещоткой / Ключ до рознімних з'єднань з трісчаткою / Racsnikulcs radiátorszelephez / Cheie pentru imbinari de tevi cu clichet / Klíč na šroubení s ráčnou / Klíč na nákrutky s ráčnou / Večstopenski ključ z ragljo / Raktas sujungimams su terkšle / Savienotājuztavas tarkškatslēga / Kõristiga torulitmikuvõti / Ключ за съединителни муфи със зъвначо / Imbus ključ sa čegrtaljkom / Ključ za aramturu sa čegrtaljkom / Kleidi για λιούμενες συνδέσεις με κατσάνα / Chiave a cricchetto / Chiave a cricchetto per raccordi / Chave para junção com catraca / Clé pour garniture de raccord à cliquet / Sleutel voor koppelstukken met ratel

NEO TOOLS

25 years  
GUARANTEE

CrV  
steel

1/2"

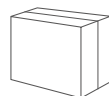

Ref.	info	☒	EAN
02-060	3/8" - 9,5 mm; 15/32" - 12 mm; 1/2" - 12,7 mm 21/32" - 16,8 mm; 7/8" - 22 mm	0/20	5907558418804

## Końcówka klucza do śrubunków

Step wrench bit / Rohrverschraubung / Разъемное соединение / Проставка / Racsnis kulcs / Connector Filetat / Sroubeni / Nákrutka / Fiting / Varžtas / Savienotājuzstava / Mutter / Съединителна муфа / Cijevna spojnica / Zavrtanj / Λοομενη συνδεση / Tuercas / Raccordo / Junção / Raccord-union

NEO TOOLS



CrV  
steel

1/2"

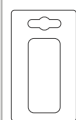

Ref.	info	☒	EAN
02-069	3/8" - 9,5 mm; 15/32" - 12 mm; 1/2" - 12,7 mm 21/32" - 16,8 mm; 7/8" - 22 mm	0/50	5907558415742

NEO TOOLS



CrV  
steel

2in1

1/2"  
WRENCH

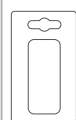

Ref.	info	☒	EAN
02-443	1/2", 3/8", 15/32"	20/80	5907558464573



## Klucz łańcuchowy do rur

Chain pipe wrench / Kettenschlüssel für Rohre / Ключ трубный цепной / Ключ трубный ланцюговий / Csőfogó láncos / Cheie pentru filtrul cu lant / Řetězový hasák na trubky / Ključ reťazový na rúry / Veržni ključ za cevi / Grandininis raktas, vamzdžiams / Κέδες σαυρούλι ατσίλεγα / Kett-toruvõti / Веружен тръбен ключ / Lančani ključ za cijevi / Κλυσκαβουρας σωληνων / Llave de cadena para tubos / Giratubi a catena / Chave de corrente p. tubos / Clef à chaîne pour tubes / Kettingsleutel voor buizen

NEO TOOLS

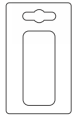

Ref.	L [mm]	Ra [mm/"]	☒	EAN
02-444	300	115/4	0/24	5907558481570

## Imadło do rur

Pipe Vice / Rohrschraubstock / Тиски трубные / Лещата для труб / Csőszatu / Menghina de tevi / Trubkový svěrák / Zverák na rúrky / Primež za cevi / Vamzdžiu spaustuvai / Cauruļu spīles / Torukruustangid / Менгеме за тръбу / Stega za cijevi / Stege za cev / Μέγγενη σωληνων / Mordaza de tuberías / Morsa per tubi / Torno para tubos / Etou pour tubes / Bankschroef voor buizen

NEO TOOLS



10-60 mm

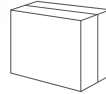

Ref.	Ra [mm]	☒	EAN
02-411	10 - 60	0/6	5907558463019

## Obcinak do rur

Tube cutter / Rohrschneider / Трубкопез / Трубкопиз / Csővágó / Dispozitiv tăiere țevi / Trubkořez / Rezač rúrok / Rezalec cevi / Žirkles vamzdžiams / Caurulgriezējs / Torulöikur / Трубкопез / Rezač cijevi / Sekac za cevi / Κόπτης σωληνων / Cortador de tubos / Taglia tubi / Cortador p. tubos / Coupe-tube / Buisknipper

NEO TOOLS



02-010

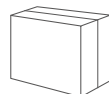

Ref.	info	☒	EAN
02-010	35 max ø [mm]	6/36	5907558408461
02-005	3 x	40/200	5907558408973

NEO TOOLS



02-407

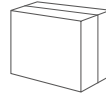

Ref.	Ra ["]	Ra [mm]	☒	EAN
02-429	1/8-7/8	3-22	50/200	5907558463514
02-407	x6	40/200	40/200	5907558462975

NEO TOOLS



02-042

STEEL

02-044

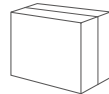

Ref.	info	Ra [mm]	Ra ["]	☒	EAN
02-042	-	3-50	1/8-2.0	0/8	5907558414332
02-044	2 x	-	-	24/288	5907558415735

NEO TOOLS



02-040

02-041

25 years GUARANTEE

TÜV Rheinland CERTIFIED

max 2.5mm

STEEL

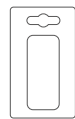

Ref.	Ra [mm]	Ra ["]	☒	EAN
02-040	19-83	3/4-3.1/4	10/30	5907558410006
02-041	-	-	20/80	5907558410013

NEO TOOLS

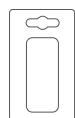

Ref.	max ø [mm]	☒	EAN
02-020	45	6/24	5907558408478

NEO TOOLS



02-073

02-074

02-075

RUBBER HANDLE

Replaceable BLADE

PCV

PP



02-076, 02-077, 02-078

Ref.	max ø [mm]	☒	EAN
02-073	42	10/40	5907558442847
02-074	50	10/40	5907558442854
02-075	63	10/40	5907558442861
02-076	-	12/72	5907558442885
02-077	-	12/72	5907558442892
02-078	-	12/72	5907558442878



## Obcinak do rur

Tubing cutter / Rohrabschneider / Τρυβορέζ / Τρυβορία / Csővágó / Dispozitív táiere țevi / Trubkořez / Rezač rúrok / Rezalec cevi / Žirkles vamzdažiams / Caurulgriezējs / Torulõikur / Τρυβορέζ / Rezač cijevi / Sekac za cevi / Κόπτης σωλήνων / Cortador de tubos / Taglia tubi / Cortador p. tubos / Coupe-tube / Buisknipper

**NEO**  
TOOLS

CU AL 3-32 mm 1/8"-1/4"



02-407

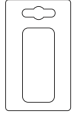

Ref.	Ra [°]	Ra [mm]	☒	EAN
02-403	1/8-1.1/4	3-32	12/48	5907558462937
02-407	x6	40/200		5907558462975

**NEO**  
TOOLS

CU AL 3-30 mm 1/8"-1/4"



02-407



Ref.	Ra [°]	Ra [mm]	☒	EAN
02-402	1/8-1.1/4	3-32	12/72	5907558462920
02-407	x6	40/200		5907558462975

**NEO**  
TOOLS

STEEL 12-50 mm 1/2"-2"



02-409

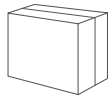

Ref.	Ra [°]	Ra [mm]	☒	EAN
02-406	1/2 - 2	12-50	0/10	5907558462968
02-409	-	20/100		5907558462999

**NEO**  
TOOLS

CU AL PLASTIC 50-127 mm 2-5" QUICK ADJUSTING



02-442

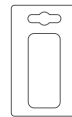

Ref.	Ra [°]	Ra [mm]	☒	EAN
02-430	2-5	50-127	0/10	5907558464580
02-442	-	0/200		5907558464689

**NEO**  
TOOLS

PVC PE PP 6-63 mm 1/4"-2 3/8"



02-408

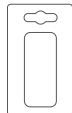

Ref.	Ra [°]	Ra [mm]	☒	EAN
02-405	1/4-2.3/8	6-63	6/24	5907558462951
02-408	x6	40/200		5907558462982

**NEO**  
TOOLS

PCV PE PP 0-42 mm



Ref.	Ra [°]	Ra [mm]	☒	EAN
02-404	0-1.5/8	0-42	6/36	5907558462944

**T TOPEX**

Cu AL



Ref.	Ra [°]	Ra [mm]	☒	EAN
34D032	1/8-1.1/4	3-32	12/72	5902062340320

**TOP TOOLS**

CU AL



Ref.	L [mm]	Ra [mm]	☒	EAN
34D055	165	3-28	10/80	5902062080561



## Obcinak do rur

Tubing cutter / Rohrabscneider / Труборез / Τρυβορις / Csővágó / Dispozitiv tăiere țevi / Trubkořez / Rezač rúrok / Rezalec cevi / Žirkles vamzdžiams / Caurulgriezējs / Torulõikur / Τρυβορες / Rezač cijevi / Sekac za cevi / Κόπτης σωλήνων / Cortador de tubos / Taglia tubi / Cortador p. tubos / Coupe-tube / Buisknipper

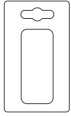

Ref.	L [mm]	Ra [mm]	☒	EAN
34D065	200	3-42	0/48	5902062080554

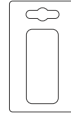

Ref.	Ra [mm]	☒	EAN
34D067	3-42	0/48	5902062049896

## Gratownik

Trimmer / Entgrater / Зенковка для труб / Гратознімач / Sorjázó / Debavurator / Odhrotovač / Skracovačka / Sveder za cev / KIRSTUKAS vamzdžiams / Cauruļu gremdurbis / Kraatide eemaldi / Τρυμερ / Strugač za cijevi / Alat za uklanjanje opriljaka / Αλεξούρα για σωλήνες / Desbarbador de tubo / Sbvatore per tubi / Rebarbador de tubos / Ebavureur / Ruimer



02-066



02-072

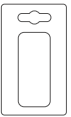

Ref.	Info	☒	EAN
02-066		0/150	5907558418866
02-072	3 x	10/300	5907558415759

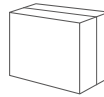

Ref.	Ra ["]	Ra [mm]	☒	EAN
02-410	1/4-1.5/8	6-40	24/72	5907558463002

## Przyrząd do modelowania końcówek rur

Tubbing cutter and flaring tool set / Gerät zum Modellieren von Rohrenden / Труборез и развальцовщик, набор / Комплект інструменту до порізки та розвальцовки труб / Csővágókészlet / Dispozitiv pentru modelarea pieselor de îmbinarea țevilor / Zařizení na tvarování nástavců trubek / Sada nástrojov na modelovanie nástavcov rúr / Orodje za rezanje in robljenje cevi / Vamzdžiu antgaliu užspaudimo ir praplétimo įrankių rinkinys / Caurulgriezēju un cauruļu izvelmētāju komplekts / Komplekt torude lõikamiseks ja valtsimiseks / Комплект інструменти за рязане и моделуране краищата на тръби / Alat za pazezivanje i modeliranje cijevi / Pribor za modelovanje krajeva cevi / Κόπτης σωλήνων και εργαλείο για διεύρυνση σωλήνων, σετ / Herramienta para amoldar las puntas de tubos / Utensile per modellare il fine tubo / Aparelho p. formar ponteiros de tubos / Outil de modelage d'embouts de tubes / Knijgereedschap voor eindstukken

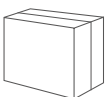

Ref.	Ra [mm/"]	☒	EAN
02-050	4, 4.75, 6, 8, 10, 12, 14 mm	0/12	5907558410020

## Praska do zaciskania złączek PEX

Crimping tool for PEX connectors / Crimpresse für PEX-Klemmen / Пресс-инструмент с обжимными губами PEX / інструмент для опресування муфт PEX / Prés PEX с обжимомк преселесéhez / Presă de sertizare pentru fittinguri PEX / Krimovací nástroj pro lisování spojek PEX / Lisovacie kliešte na spoje PEX / Stiskalnik za stiskanje sponk PEX / Jungčių suspaudimo presas PEX / Prese PEX savienojumu saspiešanai / Pex-ühenduste kokkpressimise tangid / Преса за пресоване на PEX фитингу / Presa za stezanje spojki PEX / Presa za stezanje spojki PEX / Преса σύσφιξης συνδέσμων PEX / Crimpadora para conectores PEX / Crimpatrice per giunti PEX / Alicata de crimpagem de conectores Pex / Outil de sertissage pour raccords PEX /



Ref.	☒	EAN
02-445	0/4	5907558482027





## Kalibrator do rur PEX

PEX pipes calibration tool / Kalibriergerät für PEX-Rohre / Калубратор для труб PEX / Калибратор для труб PEX / Kalibrátor PEX csövekhez / Calibrator pentru țevi PEX / Kalibrátor pro potrubí PEX / Kalibrátor pre rúry PEX / Kalibrator za PEX cevi / Pex vamzdžių kalibratorius / PEX sauruļu kalibrators / PEX-torude kalibrator / Калубратор за тръби PEX / Kalibrator za PEX cijevi / Alat za kalibriranje PEX cevi / Βαθμονομητής σωλήνων PEX / Calibrador de tubos PEX / Calibratore di tubi PEX / Calibrador para tubos PEX / Calibreur des tubes PEX / PEX-buis kalibrator

NEO  
TOOLS



Ref. 02-434    0/200    EAN 5907558464627

## Sprężyna do gięcia rur PEX

PEX pipe bending spring / Feder für das Biegen der PEX-Rohre / Пружина для гибки труб PEX / Пружина для згинання труб PEX / Rugó PEX csövek hajlításához / Arc de indoire a țevilor PEX / Pružina pro ohýbání trubek PEX / Pružina na ohýbanie rúr PEX / Vmet za upogibanje PEX cevi / PEX vamzdžių lenkimo spyruoklė / Atspere PEX sauruļu locīšanai / PEX-torude painutusvedru / Пружина за огъване на тръби PEX / Opruga za savijanje PEX cijevi / Opruga za savijanje PEX cevi / Ελατήριο κάμψης σωλήνων PEX / Resorte para doblar tubos PEX / Molla piegatubi PEX / Mola para doblar tubos PEX / Ressort de cintrage pour tubes PEX / Buigveer voor PEX-buizen

NEO  
TOOLS

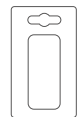

Ref.	Ø [mm]	L [mm]	☒	EAN
02-431	16	760	0/50	5907558464597
02-432	20	760	0/40	5907558464603
02-433	25	760	0/30	5907558464610

## Giętarka do rur

Tube bender / Rohrbiegemaschine / Трубогуб / Пристрій для гнуття труб / Csőhajlító / Aparat de îndoit țevi / Ohýbačka trubek / Ohýbačka na rúry / Naprava za krivljenje cevi / Vamzdžių lenkimo prietaisai / Sauruļu liecējs / Torurainuti / Огъвачка за тръби / Savijač za cijevi / Savijačica za cevi / Κοιμηπαρόρας / Doblador de tubos / Piegatrice per tubi / Máquina de curvar p. tubos / Cintreuse pour tubes / Buigbank voor buizen

NEO  
TOOLS



Ref. 02-439    0/30    EAN 5907558464665

## Nić do uszczelniania gwintów

Thread sealing thread / Naht für die Abdichtung der Gewinde / Нить для уплотнения резьбы / Нитка для ущільнення різьби / Menettömítő cérna / Fir de etanșare a filetelor / Nit pro těsnění závitů / Tesniaca niť na závitů / Tesnilna nit za navoje / Sriegiļu sandarinimo siūlas / Vītņu blīvēšanas diegs / Keermethendusiit / Нонцу за ущільнюване резбурте / Nit za brtvljenje navoja / Конас за brtvljenje navoja / Nihma στεγανοποίησης νήματος / Hilo de sellado de roscas / Filo sigillante per filettature / Fio para selar roscas / Fil d'étanchéité pour raccords filetés / Afdichtingsdraad voor schroefwikkelingen

NEO  
TOOLS



Ref. 02-438    25/125    EAN 5907558464658

## Zestaw uszczelniający

Sealing set / Набор для уплотнения / Set de etanșare / Menettömítő készlet / Набор герметизирующий / Tesniaca súprava / Těsnící souprava / Dichtungssatz / Tesnilni set / Sandarinimo komplektas / Blivėjuma kompleks / Tihenduskomplekt / Уплътнителен комплект / Set za brtvljenje / Заптивни сет / Σετ απράγιας / Juego de sellado / Set sigillante / Conjunto de vedação / Kit d'étanchéité / Afdichtingsset

NEO  
TOOLS



Ref. 02-109    0/2    EAN 5907558435870

## Spirala kanalizacyjna

Plumber snake / Rohrspirale / канализационная спираль / Спираль канализаційна / Csőtisztító spirál / Spirala canalizare / kanalizační spirála / kanalizačná špirála / Kanalizacijska spirala / Kanalizacijos valymo spirālė / Kanalizācijas spirāle / Kanalisatsioonitross / канализационна спирала / Kanalizacijska spirala / Kanalizaciona spirala / Αποφρακτικός άξονας σπирάλ / Pulitore per tubi di scarico / Espiral de esgotos / Furet de plombier / Riioalspiraal

TOP TOOLS



Ref.	Ø [mm]	L [m]	☒	EAN
34D301	5	1.5	20/80	5902062343017
34D305	8	5	10/20	5902062343055
34D308	10	8	0/8	5902062343086



## Zgrzewarka

Welder / Schweißmaschine / Сварочный аппарат / Пристрій до зварювання / Csőhegesztőgép / Masina de sudat / Svářečka / Zváračka / Varilnik / Suvirinimo aparatas / Metināšanas aparāts / Keevitusaparaat / Заварьча машина / Aparat za varenje / Zavarivač / Μηχάνημα συγκόλλησης / Soldadora / Polifusore per tubi in plastica / Máquina de solda / Soudeuse / Lasapparaat

**NEO**  
TOOLS



**NEO**  
TOOLS



**NEO**  
TOOLS



**NEO**  
TOOLS



**NEO**  
TOOLS



## Tuleja grzewcza

Heating sleeve / Heiztülle / Насадки к аппарату для сварки полимерных труб / Втулка нагрівальна / Melegítő toldat / Matrite pentru lipire tevi plastic / Ohřivací nástavec / Ohřevací nadstavec / Grelna tulka / Suvirinimo mova / Metināšanas uzgālis / Süütedüüs / Нагревательная втулка / Grijača pri rubnica / Grejni tulac / Μούφες για μηχανήμα συγκόλλησης πολυμερών σωλήνων / Casquillos de calentador / Manicotto per polifusore / Casquilho aquecedor / Tubulaire de chauffage / Verwarmingsmouw

**NEO**  
TOOLS



## Śruba do tulei grzewczej

Screw for heating sleeve / Schraube für Heiztülle / Крепеж к насадкам / Гвинт до нагрівальної втулки / Csavar toldathoz / Surub matrita lipire tevi plastic / Šroub pro ohřivací nástavec / Šroub pro ohřevací nadstavec / Grelna tulka / Suvirinimo movos varžtas / Metināšanas uzgaļa skrūve / Süütedüüsi kruvi / Болт за нагревателната втулка / Vijak za grijaču pri rubnicu / Zavrtanj grejnog tulca / Βίδα για μούφες / Tornillo para casquillo de calentador / Vite per polifusore / Parafuso para casquilho aquecedor / Vis à de tubulure de chauffage

**NEO**  
TOOLS

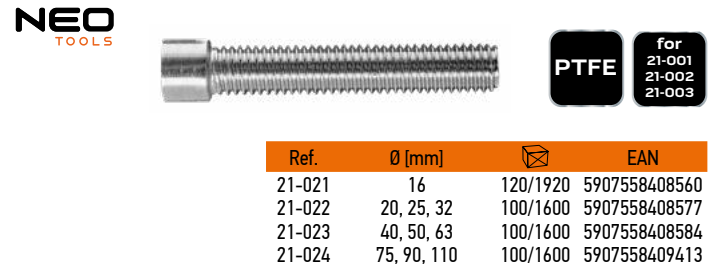

**NEO**  
TOOLS

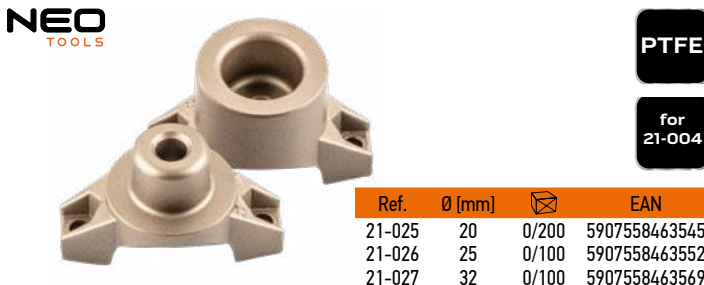

## Klucz nastawny

Adjustable wrench / Schraubenschlüssel / Ключ разводной / Ключ розвідний гайковий / Csavarkulcs állítható / Cheie reglabilă / Ključ přestavitelný / Nastavitel'nyj ključ / Francoski ključ / Reguluojamas raktas / Bidatslēga / Tellitan vōti / Раздвижен гаечен ключ / Podesivi ključ / Francuski ključ / Γαλλικό κλειδί / Llave inglesa / Chiave a rullino / Chave regulável / Clef à ouverture réglable / Verstelbare moersleutel

**NEO**  
TOOLS

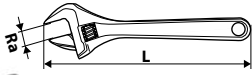

**25**  
years  
GUARANTEE

**CrV**  
steel



Ref.	Ra [mm]	L [mm]	⊠	EAN
03-017	0-30,5	200	0/36	5907558404326



**NEO**  
TOOLS

**25**  
years  
GUARANTEE

**TUV**  
Rheinland  
CERTIFIED

**CrV**  
steel

**DIN**  
3117



Ref.	L [mm]	Ra [mm]	⊠	EAN
03-015	150	0-34	6/96	5907558412208
03-014	200	0-38	6/72	5907558404159
03-016	250	0-50	5/30	5907558412215



**NEO**  
TOOLS

**25**  
years  
GUARANTEE

**CrV**  
steel



Ref.	L [mm]	Ra [mm]	⊠	EAN
03-023	155	0-28	6/72	5907558426052
03-024	205	0-32	6/72	5907558426069
03-025	256	0-43	6/36	5907558426076
03-026	306	0-53	6/36	5907558426083



**T TOPEX**



Ref.	L [mm]	Ra [mm]	⊠	EAN
35D555	150	0-24	6/60	5902062355553
35D556	200	0-31	6/60	5902062355560
35D557	250	0-35	6/36	5902062355577
35D558	300	0-41	6/24	5902062355584



**T TOPEX**

**Alu**  
**ULTRA**  
**LIGHT**  
**200**  
[mm]

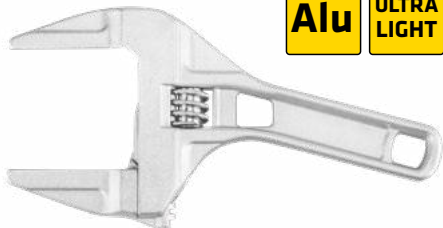

Ref.	L [mm]	Ra [mm]	⊠	EAN
35D700	200	0-70	6/60	5902062030856



**TOP TOOLS**



Ref.	L [mm]	Ra [mm]	⊠	EAN
35D111	150	0-20	6/72	5902062040169
35D112	200	0-24	6/60	5902062040176
35D113	250	0-29	6/36	5902062040183
35D114	300	0-35	6/24	5902062040190
35D115	375	0-47	2/12	5902062040206



**NEO**  
TOOLS

**25**  
years  
GUARANTEE

**TUV**  
Rheinland  
CERTIFIED

**CrV**  
steel

**DIN**  
3117



Ref.	L [mm]	Ra [mm]	⊠	EAN
03-010	150	0-24	6/120	5907558404111
03-011	200	0-28,6	6/60	5907558404128
03-012	250	0-32,8	6/48	5907558404135
03-013	300	0-38	6/24	5907558404142



**NEO**  
TOOLS

**25**  
years  
GUARANTEE

**CrV**  
steel



Ref.	L [mm]	Ra [mm]	⊠	EAN
03-027	150	0-23	6/120	5907558426090
03-028	200	0-28	6/60	5907558426106
03-029	250	0-32	6/48	5907558426113



**NEO**  
TOOLS

**25**  
years  
GUARANTEE

**CrV**  
steel

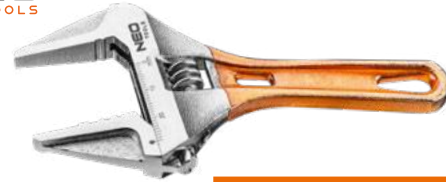

Ref.	L [mm]	Ra [mm]	⊠	EAN
03-019	118	0-28	6/72	5907558426014
03-020	139	0-32	6/72	5907558426021
03-021	156	0-43	6/36	5907558426038
03-022	185	0-53	6/36	5907558426045



**T TOPEX**



Ref.	L [mm]	Ra [mm]	⊠	EAN
35D121	150	0-20	6/60	5902062042484
35D122	200	0-24	6/60	5902062042439
35D123	250	0-29	6/36	5902062042132
35D124	300	0-35	6/24	5902062042149



**TOP TOOLS**



Ref.	L [mm]	Ra [mm]	⊠	EAN
35D117	150	0-17	6/72	5902062031020
35D118	200	0-22	6/60	5902062031051
35D119	250	0-27	6/36	5902062031143
35D120	300	0-32	6/24	5902062031150



**T TOPEX**

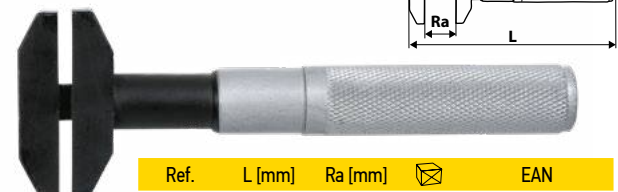

Ref.	L [mm]	Ra [mm]	⊠	EAN
35D154	260	0-55	0/5	5902062042590
35D156	260	0-65	0/5	5902062040220

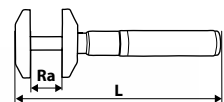

A close-up photograph of a person's hands using a pair of silver pliers with a red handle to work on a car engine. The pliers have "NEO TOOLS" and "US 8" engraved on them. In the background, a hydraulic jack is visible, with a person's foot on the handle. The jack has a label with "NEO TOOLS" and technical specifications. The scene is set in a workshop with a car's engine and various components visible.

# MOTORYZACYJNE

AUTOMOTIVE TOOLS АВТОМОБІЛЬНЕ

## Zestaw blokad rozrządu

Timing tool set / Nockenwellen-Arretierwerkzeugsatz / Набор фиксаторов распределения для установки фаз ГРМ / Набор стопорів для розподільвальних валів / Vezérműtengely blokkoló készlet / Set de blocarea distribuției / Sada blokovací pro opravu rozvodů / Súprava blokad rozvodov / Set blokad gredi / Paskirstymo velenėlių fiksavimo komplektas / Sadales mehānismu fiksatoru komplekts / Jaotuse blokeerimise komplekt / Комплект блокировки на газораспределении / Set alata za blokiranje radilice / Pribor za blokadu razvođenja / Σετ συγκράτησης κινδωκοφόρων αξόνων / Kit de bloqueo de la correa de distribución / Attrezzi di blocco dell'albero a camme / Conjunto de bloqueios de engrenagem de distribuição / Ensemble de verrouillage de distribution / Set van distributievegrendeling

NEO  
TOOLS



TDI  
VAG

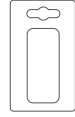

1.20 TDI PD: ANY, AYZ  
1.40 TDI PD: AMF, ATL, BHC  
1.90 TDI PD: AJM, ANU, ARL, ASZ, ATD, ATJ, AUY,  
AVB, AVF, AWX, AXR, BSW, BTB, BVK

Ref.	📦	EAN
11-300	10/40	5907558436051

NEO  
TOOLS



TDI  
VAG

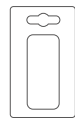

Audi: A1 (10-15), A2 (00-06), A3 (01-13), A4/Allroad (01-16), A5 (08-15), A6 (11-14), TT (08-14), Q3 (11-15), Q5 (08-15), A6 (10-14)  
Dodge: Caliber (06-11)  
Ford: Galaxy (02-06)  
Mitsubishi: Grandis (05-10), Lancer (05-10), Outlander (07-10)  
Seat: Alhambra (00-15), Altea/Altea XL (04-15), Cordoba (02-09), Ibiza (02-15), Leon (00-13), Toledo (04-11)  
Skoda: Fabia (00-14), Fabia II (07-15), Octavia (00-10), Octavia II (04-15), Praktik (10-15), Rapid (11-15), Roomster (07-15), Superb (02-08), Superb II (08-15), Yeti (09-14)  
VW: Amarok (10-16), Beetle (02-15), Bora (02-08), Caddy/Maxi (03-15), EOS (06-15), Fox (05-11), Golf (02-15), Golf Plus (05-14), Jetta (05-15), Lupo (02-05), Passat/CC (02-15), Polo (99-14), Scirocco (08-14), Sharan (02-15), Tiguan (07-15), Touran (03-15), Transporter (03-18)



Kody silników / Engine codes / Коды двигателя:

1.20 TDI CR: CFWA  
1.40 TDI PD: AMF, BAY, BMS, BNM, BNV, BWB  
1.60 TDI CR: CAYA, CAYB, CAYC, CAYD, CAYE, CLNA  
1.90 TDI PD: AJM, ANU, ARL, ASZ, ATD, AUY, AVB, AVF, AVQ, AWX, AXB, AXC, AXR, BJB, BKC, BLS, BLT, BMT, BPF, BRM, BRR, BRS, BRU, BSU, BSV, BSW, BTB, BVK, BXE, BXF, BXJ  
2.00 TDI CR/TDI PD: AZV, BDI, BDK, BEW, BGW, BHW, BKD, BKP, BKQ, BLB, BMA, BMM, BNM, BNP, BMR, BNA, BPW, BRA, BRC, BRD, BRE, BRF, BRT, BSS, BST, BSY, BUJ, BUZ, BVA, BVE, BVF, BVG, BVH, BWC, BWV, CAA, CAAB, CAAC, CAAD, CAE, CAG, CAGB, CAGC, CAHA, CAHB, CBAA, CBAB, CBAC, CBBA, CBBB, CBDA, CBDB, CBDC, CBEA, CCHA, CCHB, CDBA, CDCA, CEGA, CFCA, CFFA, CFFB, CFFD, CFFE, CFBG, CFCG, CFHA, CFHB, CFHC, CFHD, CFHE, CFJA, CGLA, CGLB, CGLC, CGLD, CJAA, CJCA, CJC, CJC, CLCA, CLCB, CLJA, CLLA, CNEA, ECD, ECD/BSY, ECD/BVL, ECE/BWD

OEM:  
Dodge: 9882, 9883  
Ford: 310-085/23-059, 303-1054  
Mitsubishi: MB995206, MB995208, MB995209  
VAG: T10100, T10050, 3359/T20102, T10115, T10060A/T40098, T20167

Ref.	📦	EAN
11-301	10/40	5907558436068

NEO  
TOOLS



TDI  
VAG

AUDI: A1, A3, A4 (B8), A5, A6 (C6, C7), TT, Q3, Q5  
VW: Golf V-VI, Passat B6, B7, Polo, Jetta V-VI, Scirocco III, Beetle II, Caddy, Touran, Sharan II, T5  
SKODA: Fabia, Roomster, Practice, Octavia II, Superb II, Yeti  
SEAT: Ibiza, Leon, Exeo, Altea, Alhambra II



Kody silników / Engine codes / Коды двигателя:

1.6 TDI CR (> 2009): CAYB, CAYC  
2.0 TDI CR (> 2007): CAAA, CAAB, CAAC, CBAB, CBBB, CBAA, CFFB, CAGA, CAHA, CAGB, CAHB, CAGC, CCHA, CAVA, CBDA, CBDD, CBAC, CBDC

OEM: T20102 | U40074 | 3359 | T10050 | T10100 | T10264 | T10265 | T40098 | T10051 | T10052 | T10255

Ref.	📦	EAN
11-302	1/5	5907558436075

NEO  
TOOLS



TDI  
VAG



Audi: A4 2.7 TDI (05-09); A4 Quattro 2.0 TDI (05-06), Q7 3.0 TDI (06-09)  
Volkswagen: Touareg 3.0 V6 TDI (08-); Phaeton 3.0 V6 TDI (06-); Diesel 2.7 TDI, 2.0 TDI 3.0 TDI



Kody silników / Engine codes / Коды двигателя  
2.7 TDI V6: BBP, BSG, CAMA, CAMB, CANA, CANC, CAND, CGKA, CGKB  
3.0 TDI V6: ASB, BKN, BKS, BMK, BMZ, BNG, BUG, BUN, CAPA, CARA, CARB, CASA, CASB, CASC, CATA, CCMA, CCWA, CCWB, CDYA, CDYB, CDYC, CEXA, 4.0 TDI V8: ASE  
OEM: T40062 | T40061 | T40049 | 3359 | T40058 | T40060 | 3242

Ref.	📦	EAN
11-303	1/5	5907558436082

NEO  
TOOLS



VAG



Benzyzna / Gasoline / Бензин: 1,2 6V/12V / 1,4 16V / 1,6 16V / 1,4FSI / 1,6FSI  
Diesel: 1,2TDi / 1,4TDi / 1,9TDi / 2,0TDi / 2,5 V6 TDI / 3,3 V8 TDI / 2,0TDi (PD oraz CR) / 1,6 TDI CR

Kody silników / Engine codes / Коды двигателя

ANY, ASZ, ATD, AMF, ATL, BHC, AXR, AVB, AVX, AMF, BMS, BNM, BNV, ANU, ARL, AUY, BTB, BVK, BJB, BKC, AZV, BKD, AXB, BDI, BST, AJM, AYZ, BWB, BAY, AXG, AXL, AYC, AVQ, BMP, BRM, BRU, BSU, BXE, BFM, BDK, AZU, BMM, ATJ, BGW, BHW, ACY, AHY, AJ  
OEM: T10123 | T10120 | 3458 | 3418 | 2065A | 3366 | T10098 | T10121 | 3242 | T10050 | T10100 | T10060A | T10020 | T10008 | T40011 | 3359 | 2064 | 3369 | T10016 | T10264 | T10265

Ref.	📦	EAN
11-304	1/4	5907558436099

NEO  
TOOLS



VAG



AUDI: A3, S3, A5, A6, TT (03-11), SEAT: Ibiza, Leon, Altea, Exeo (04-11)  
SKODA: Fabia II, Octavia II, Roomster, Superb II (04-11), VW: Golf, Golf Plus, Jetta, Eos, Scirocco, Tiguan, Touran, Passat (03-11)



Kody silników / Engine codes / Коды двигателя:  
2.0FSI: AWA, AXW, BHD, BLR, BLX, BLY, BMB, BVX, BVY, BVZ  
2.0TFSI: AXH, BGB, BHZ, BPG, BPJ, BPY, BUL, BWA, BWE, BWJ, BWT, BYD, BYK, BZC, CDLA, CDLB, CDLC, CDLD, CDMA  
OEM: T10020 | T10252 | T10092 | T10115 | T10060A | 3366 | T40011

Ref.	📦	EAN
11-306	1/10	5907558436112



## Zestaw blokad rozrządu

Timing tool set / Nockenwellen-Arretierwerkzeugsatz / Набор фиксаторов распределителя для установки фаз ГПМ / Набор стопорів для розподілювальних валів / Vezérműtengely blokkoló készlet / Set de blocarea distribuției / Sada blokovací pro opravu rozvodů / Súprava blokad rozvodov / Set blokad gredi / Paskirstymo velenėlių fiksavimo komplektas / Sadales mehānismu fiksatoru komplekts / Jaotuse blokeerimise komplekt / Комплект блокировки на газораспределителе / Set alata za blokiranje radilice / Pribor za blokadu razvođenja / Σετ συγκράτησης κινωδοφόρων αξόνων / Kit de bloqueo de la correa de distribución / Attrezzi di blocco dell'albero a camme / Conjunto de bloqueios de engrenagem de distribuição / Set van distributievegrendeling

**NEO**  
TOOLS



Audi: A1 (10-15), A3 (03-13)  
Seat: Alhambra (10-15), Altea/Altea XL (08-15), Ibiza/Cordoba (08-12), Leon (07-13), Toledo (07-15)  
Skoda: Fabia II (07-15), Octavia II (04-15), Praktik (10-15), Rapid (12-15), Roomster (06-15), Superb II (09-14), Yeti (09-14)  
VW: Beetle (11-15), Caddy/Caddy Maxi (10-15), EOS (06-12), Golf (03-12), Golf Plus (03-14), Golf V Estate (07-13), Golf VI Cabriolet (10-15), Jetta (06-14), Passat (05-11), Polo (02-14), Scirocco (08-12), Tiguan (07-12), Touran (03-15)



Kody silników / Engine codes / Коды двигателя:

1.2 TFSI: CBZA, CBZB, CBZC  
1.4 FSI: AXU, BKG, BLN  
1.4 TFSI: BLG, BMY, BWK, CAVA, CAVB, CAVC, CAVD, CAVE, CAVF, CAXA, CAXC, CDGA, CSMA  
1.6 FSI: BAG, BLF, BLP, BTS  
OEM VAG: T10170, T10171A, T40011, T10340, T10414

Ref.	📦	EAN
11-305	1/10	5907558436105

**NEO**  
TOOLS



AUDI: A1 - A1 Sportback - A3 - A3 Sportback - A3 CABRIO - S1 - S1 Sportback  
SEAT: Alhambra - Altea - Altea XL - Ibiza - Leon - Cordoba - Toledo  
SKODA: Octavia II - Praktik - Roomster - Suberb II - Yeti - Yeti Outdoor - RAPID - Rapid Spaceback - Superb II  
VW: Beetle - Caddy - Caddy Maxi - Eos - Golf Plus - Golf V - Golf V Estate - Golf VI - Golf VI Cabrio - Golf VI Estate - Jetta - Passat - Polo - Scirocco - Sharan - Tiguan - Touran - CC



Kody silników / Engine codes / Коды двигателя:

1.2 FSI/TFSI: CBZA - CBZB - CBZC  
1.4 TSI /1.4 / 1.6 FSI: AXU - BAG - BKG - BLF - BLG - BLN - BLP - BMY - BTS - BWK CAXA (03-)

OEM VAG: T10340, T10414, T10171A, T40011, T10170, VAS6079, T10341

Ref.	📦	EAN
11-307	1/5	5907558436129

**NEO**  
TOOLS



Audi: A3 (2013-)  
Seat: Mi (2012-), Leon (2012-), Toledo (2012-)  
Skoda: Citigo (2012-), Octavia (2013-), Rapid (2012-)  
VW: Up (2012-) and Polo mk5 (2014-), Golf VII (2012-), Jetta (2012-)



1.0 Ecofuel, Ecomotive, Bluemotion, Green Tech CHYA, CHYB, CPGA  
1.2 TFSI: CJZA, CJZB  
1.4 TFSI: CMBA, CXSA, CHPA  
1.4 TGI: CPWA  
1.4 TSI Multi Fuel CPVA  
1.4 Hybrid CRJA  
OEM VAG: T10340, T10477, T10476, T10499, T10494, T10487

Ref.	📦	EAN
11-338	0/2	5907558451214

**NEO**  
TOOLS



116i E81/82/87/88 (07-12), 118i E81/82/87/88 (06-14), 120i E81/82/87/88 (06-14)  
BMW 3 Series: 316i E90/91/92/93 (07-11), 318i E90/91/92/93 (07-13), 320i E90/91/92/93 (07-14)  
BMW 5 Series: 520i E60/61 (07-10)



Kody silników / Engine codes / Коды двигателя:  
N43: B16A/AA, B16AA, B16AA/00, B20A, B20A/AA, B20AA, B20AY, B20KO, B20UO  
OEM BMW: 11.8.690 (11.8.691/11.8.692/11.8.693), 11.9.340 (11.9.341/11.9.342), 11.8.710 (11.8.711/11.8.712), 11.3.340, 11.5.120, 11.8.700

Ref.	📦	EAN
11-310	1/5	5907558436136

**NEO**  
TOOLS



BMW 1 Series: 118i E81/82/87/88 (04-14), 120i E81/82/87/88 (04-14)  
BMW 3 Series: 316i/ti Compact E46 (01-07), 318i/ti Compact E46 (01-07), 318i E90/91/92/93 (05-12), 320i E90/91/92/93 (05-14)  
BMW 5 Series: 520i E60/61 (07-10)  
BMW X Series: X1 E84 sDrive 18i (10-12), X1 E84 xDrive 18i (10-12), X3 E83 2.0 (05-10)  
BMW Z Series: Z4 2.0 E85/86 (04-09)



Kody silników / Engine codes / Коды двигателя:

2.0:  
N42 B18A, N42 B20A, N46 B18, N46 B20, N46 B20B, N46T B20, N46T B20B, N46T B20BD, N46T B20BZ, N46T B2002, N46T B202  
OEM BMW: 11.9.310 | 11.9.320 | 11.9.302 | 11.9.301 | 11.9.290 | 11.9.302 | 11.9.340 | 11.9.390 | 11.9.350 | 11.9.270 | 11.2.300 | 11.9.190 | 11.9.330

Ref.	📦	EAN
11-313	1/5	5907558436167

**NEO**  
TOOLS



BMW 1 Series: 118i E81/82/87/88 (04-14), 120i E81/82/87/88 (04-14)  
BMW 3 Series: 316i/ti Compact E46 (01-07), 318i/ti Compact E46 (01-07), 318i E90/91/92/93 (05-12), 320i E90/91/92/93 (05-14)  
BMW 5 Series: 520i E60/61 (07-10)  
BMW X Series: X1 E84 sDrive 18i (10-12), X1 E84 xDrive 18i (10-12), X3 E83 2.0 (05-10)  
BMW Z Series: Z4 2.0 E85/86 (04-09)



Kody silników / Engine codes / Коды двигателя:

2.0: N42 B18A, N42 B20A, N46 B18, N46 B20, N46 B20B, N46T B20, N46T B20B, N46T B20BD, N46T B20BZ, N46T B2002, N46T B202  
OEM BMW: 11.9.301, 11.9.303, 11.9.310, 11.9.320, 11.9.390

Ref.	📦	EAN
11-312	1/5	5907558436150



## Zestaw blokad rozrządu

Timing tool set / Nockenwellen-Arretierwerkzeugsatz / Набор фиксаторов распределвала для установки фаз ГРМ / Набор стопорів для розподілювальних валів / Vezérműtengely blokkoló készlet / Set de blocarea distribuției / Sada blokovací pro opravu rozvodů / Súprava blokad rozvodov / Set blokad gređi / Paskirstymo velenėlių fiksavimo komplektas / Sadales mehānisma fiksatoru komplekts / Jaotuse blokeerimise komplekt / Комплект блокировки на газораспределении / Set alata za blokiranje radilice / Pribor za blokadu razvođenja / Σετ συγκράτησης κινωδοφόρων αξόνων / Kit de bloqueo de la correa de distribución / Attrezzi di blocco dell'albero a camme / Conjunto de bloqueios de engrenagem de distribuição / Ensemble de verrouillage de distribution / Set van distributievengrendeling

NEO TOOLS



BMW 1 Series: 125i E88 (07-13), 128i E82/88 (07-08), 130i E81/87 (05-12), 135i/S E82 (07-11), M Coupe (11-12)  
 BMW 3 Series: 323i E90/91/92/93 (04-11), 325i E90/91/92/93 (05-13), 328i E90/91/92/93 (04-08), 330i E90/91/92/93 (04-14), 335i E90/91/92/93 (05-11)  
 BMW 5 Series: 523i/Li E60/61/F10/11 (04-11), 525i E60/61 (04-10), 528i E60/61/F10/11 (06-11), 530i E60/61/F10/11 (04-13), 535i E60/61 (04-08)  
 BMW 6 Series: 630i E63/64 (04-11)  
 BMW 7 Series: 730i E65/66 F01/02/04 (04-11), 740i F01/02/04 (08-12)  
 BMW X Series: X1 E84 xDrive 20i (11-14), X1 E84 sDrive 20i(11-14), X1 E84 xDrive 28i(11-14), X1 E84 3.0 xDrive25i (10-11), X1 E84 xDrive28i (09-11), X3 F25 20i (11-14), X3 E83 2.5Si (06-10), X3 E83 3.0i/Si (06-10), X3 F25 3.0 xDrive 28i (11-13), X5 E70 3.0Si/xDrive 30i (06-10), X6 E71/72 3.0 xDrive35i (08-10)  
 BMW Z Series: Z4 E85/E6 2.5i/Si (05-09), Z4 E85/E6 3.0i/Si (05-09), Z4 E89 2.5 sDrive23i (09-11), Z4 E89 3.0 sDrive 30i (09-11), Z4 E89 3.0 sDrive 35i/si (09-13)



Kody silników / Engine codes / Коды двигателя:  
 N52/N52K: B25A, B25A/O1, B25AE, B25AF, B25BE, B25O1, B25O2, B25U1, B30/O2, B30A, B30A/O1, B30AE, B30AF, B30O2, B30U1  
 N53/N54: B25A, B30A, B30A/AA, B30A/O0, B30A/T0, B30O0, B30TD, B30U0  
 OEM BMW: 110300 | 114280 | 114281 | 114282 | 114283 | 114290 | 118520

Ref. 11-311 EAN 5907558436143

NEO TOOLS



BMW:  
 118d / 120d: E87:  
 318d / 318td Compact / 320td Compact / 320d / 330d: E46:  
 316i: 316ti, 318ci, 318ti, 320i E90/E91:  
 318i: 320i E90/E91/E92/E93: 520d / 525d / 530d: E39:  
 318tds / 318tds Compact (1994-2000) / 325td / tds (1991-99): E36  
 525d / 530d / 535d: E60/E61:  
 525td/ tds (1991-2003): E34/E39  
 635d: E63:  
 725tds (1991-2003) M47 / M47 TU / T2 / M57 TU / T2: E38:  
 730d: E38/E65/E66:  
 X3: 2.0i d / 3.0i d E83:  
 X5: 3.0i d E53/E70:  
 Land-Rover  
 Range Rover: 2.5 TD (1994-2002)  
 Range Rover: 3.0 TD6 (2002-2006)  
 Freelander: 2.0 TD4 (2002-2006)



Kody silników / Engine codes / Коды двигателя:  
 M41, M51, M47 - M47 TU/T2, M57 TU/T2: 2.0i - 1998 - 2008  
 OEM BMW: 11 2 300 | 11 3 320 | 11 3 340 | 11 3 360 | 11 5 180 | 11 6 080 | 11 6 320 | 11 6 321 | 11 6 322 | 13 5 120 | 13 5 190 | 13 5 191 | 13 5 192  
 OEM Land Rover: LRT-12-108 | LRT-12-112 | LRT-12-115 | LRT-12-114 | LRT-12-119  
 OEM Opel: KM-6267 | KM-6269 | KM-6268 | KM-813 | KM-823

Ref. 11-316 EAN 5907558436198

NEO TOOLS



BMW: N42 / N46 / N46T - Valvetronic  
 Seria 1: E87 118i/120i (04-10)  
 Seria 3: E46 316i/316ti Compact, 318ti Compact (01-05), 318i (01-07), E90 318i (05-08)  
 Seria 5: E90 520i (04-08), X3 E83 2.0i (05-09)



Kody silników / Engine codes / Коды двигателя:  
 N46, B18, B20B, B20, N42, B18A, B20A, N46T  
 OEM BMW: 11 3 350 | 11 9 293 | 11 9 292 | 11 9 291 | 11 9 291 | 11 9 340 | 11 5 120 | 11 9 270 | 11 9 190

Ref. 11-314 EAN 5907558436174

NEO TOOLS



Citroen: AX, ZX, XM, Xsara, Xantia, Dispatch, Evasion, Berlingo, Jumpy, C2, C3, C5  
 Peugeot: 106, 205, 206, 305, 306, 307, 309, 405, 406, 406 Coupe, 605, 607, 806, 807, Express, Expert, Partner, Boxer.



Silniki / Engines / Двигатели:  
 Benzyna / Gasoline / Бензин: 1,0 / 1,1 / 1,4 / 1,6 / 1,8 / 2,0 / 2,0 HPI  
 Diesel: 1,8 / 1,9 / D / TD 1,4 / 2,0 / 2,2 / HDI 2,1 / 2,2 / 2,5 / TD  
 OEM: 4 4507-TJ | 0132X | 9767.89 | 0132X12 | 0132Q | 5711-TA | 4507-TB | 0132R | 9767.27 | 7014-TM | 4507-TA | 0132OZ | 0189-C | 0153G | 0153Y | 0153N | 0188D | 7017-TR | 0118X | 7004-TG | 7014-TJ | 7017-TR | 0132AB | 4527-TS2 | 5711-TD | 0189-B | 5711-TC | 9041-TZ | 0188-H | 4527-T-S1 | 0132AJ2 | 0188M | 4533-TAC2 | 0132AJ1 | 4533TAC1 | 0189-A | 0189AZ | 0189-L | 0188Y | 0288D | 7099-TM | 7014-TJ | 0188P/P2 | 7015T | 0134AF | 0188F | 9044

Ref. 11-320 EAN 5907558436211

NEO TOOLS



BMW 1.6 2.0 3.0 d  
 118d E81; 118d E87 - (2006-2010)  
 120d E81; 120d E82; 120d E87 - (2006-2010)  
 123d E81; 123d E82; 123d E87 - (2007-2010)  
 318d E90; 318d E91 - (2007-2010)  
 320d E90; 320d E91; 320d E92 - (2005-2010)  
 520d E60; 520d E61 - (2006-2008)  
 X3 2.0d E83 - (2007-2010)



Kody silników / Engine codes / Коды двигателя:  
 N47; N47S D20A; N57  
 OEM BMW: 11 6 480 | 11 8 760 | 11 8 740 | 11 8 741 | 11 8 742 | 11 5 320

Ref. 11-315 EAN 5907558436181

NEO TOOLS



BMW 3 Series: 318tds E36 (94-99), 318tds Compact E36 (95-00), 325td/tds E36 (91-99)  
 BMW 5 Series: 525td/tds E34 (91-96), 525td/tds E39 (97-03)  
 BMW 7 Series: 725tds E38 (96-02)  
 Land Rover: Range Rover (94-02)  
 Vauxhall/Opel: Omega-B (94-01)



Kody silników / Engine codes / Коды двигателя:  
 1.7D: M41/174T1 2.5D: M51/256T1, M51/256T1L 2.5D Turbo: M51, 256T, 250T, X250T  
 OEM BMW: 11 2 150, 13 5 062, 11 3 340, 11 3 360, 11 3 320, 13 5 120, 11 2 300  
 OEM Land Rover: LRT-12-118, LRT-12-112, LRT-12-114, LRT-12-115, LRT-12-119, LRT-12-108  
 OEM Vauxhall/Opel: KM-819, KM-826, KM-823, KM-822, KM-811, KM-825, KM-813

Ref. 11-317 EAN 5907558436204



## Zestaw blokad rozrządu

Timing tool set / Nockenwellen-Arretierwerkzeugsatz / Набор фиксаторов распределителя для установки фаз ГРМ / Набор стопорів для розподілювальних валів / Vezérműtengely blokkoló készlet / Set de blocarea distribuției / Sada blokovací pro opravu rozvodů / Súprava blokad rozvodov / Set blokad gredi / Paskirstymo velenėlių fiksavimo komplektas / Sadales mehānismu fiksatoru komplekts / Jaotuse blokeerimise komplekt / Комплект блокировки на газораспределителе / Set alata za blokiranje radilice / Pribor za blokadu razvođenja / Σετ συγκράτησης κινωδοφόρων αξόνων / Kit de bloqueo de la correa de distribución / Attrezzi di blocco dell'albero a camme / Conjunto de bloqueios de engrenagem de distribuição / Ensemble de verrouillage de distribution / Set van distributievergrendeling

**NEO**  
TOOLS



**RENAULT**  
**OPEL**

**NEO**  
TOOLS



**PSA**



RENAULT: Clio, Clio Sport, Twingo, Kangoo, Megane, Scenic, Laguna, Espace, Safrane, Spider, R19, Master, Trafic  
OPEL: Arena, Movano  
VOLVO: S40, V40  
Gasoline engine: 1.2 / 1.4 / 1.6 / 1.7 / 1.8 / 2.0 / 2.2 / 1.4 16V / 1.6 16V / 1.8 16V / 2.0 16V / 2.5 20V  
Diesel Engine: 1.9 / 2.5 / 2.8



Kody silników / Engine codes / Коды двигателя:  
B16, B18, B20, N70, N7U, K4J, K4M, F4P, F4R, D7F, E5F, E7F, E7J, K7M, F1N, F3N, F3P, F2R, F3R, F7P, F7R, J5R, J7R, J5T, F8M, F8Q, G8T, J8S, F9D, S8U, S9U, S9W

OEM: MOT1348 | MOT1312 | MOT1135 -01 | MOT1384 | MOT1337 | MOT1496 | MOT910-1 | MOT910 | MOT861 | MOT863 | MOT1054 | MOT1318 | MOT1489 | MOT1340 | MOT1386 | MOT1490-1

Ref. 11-322 1/4 EAN 5907558436235



Citroen: C4 Picasso/Grand Picasso (06-10), C5 II (04-08), C8 (05-10), Dispatch/Jumpy (07-11), Xsara 2.0 16v, C5 1.8/2.0/HPI, Xsara Picasso 1.8/2.0 16v (02-05)  
Peugeot: 406 1.8 16v (00-04), 407 (06-10), 807 2.0 16v (02-05)



Kody silników / Engine codes / Коды двигателя:

1.8 16v: EW7A(6FY)  
2.0 16v: EW10A(RFJ), EW10ABE4(RFH), EW10J4S(RFK)  
OEM: 0189S1, 0189S2, 0132AB / 0194A/0178D, 0194B, 0188M, 0189B, 0188AH, 0189R, 70177R / 0153U, 0188J2, 0188J/J2, 0178E / 5711TE

Ref. 11-321 1/4 EAN 5907558436228

**NEO**  
TOOLS

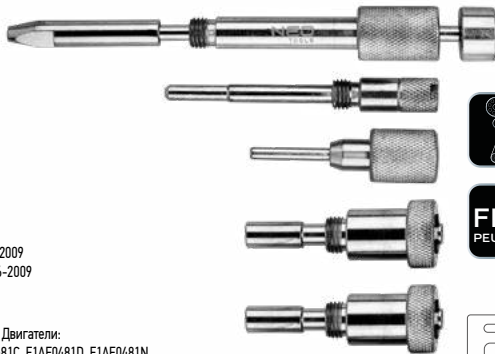

FIAT Ducato, IVECO Daily 2002-2009  
CITROEN Relay, Jumper III 2006-2009  
PEUGEOT Boxer III 2006-2009



Silniki / Engines / Двигатели:  
2.3 JTD - F1AE0481C, F1AE0481D, F1AE0481N,  
3.0 JTD - F1CE0481D (2004-)  
3.0HDI - F30DT  
OEM: 99360614(-), 0191/2.B, 99360615/2.000.018.200(-), 191/2.A, 99360608/1.860.617.000

Ref. 11-325 8/32 EAN 5907558436266

**NEO**  
TOOLS



FIAT: Panda, Idea, Doblo  
OPEL: Agila, Corsa, Astra H, Tigra B, Meriva  
ALFA ROMEO: 147, 156  
OPEL: Astra, Vectra, Signum, Zafira



Silniki / Engines / Двигатели:  
1.3 JTD MULTIJET (04-07)  
1.3 CDTI (04-07)  
1.9/2.4 JTD, 16V, 20V  
1.9 JTD 16V/2.4 JTD 20V  
1.9 CDTI (04-06)  
1.7D / 1.9 D FIAT / TD / JTD 2.4

Ref. 11-323 1/4 EAN 5907558436242

**NEO**  
TOOLS



**FIAT**  
**PEUGEOT**

**NEO**  
TOOLS



**FIAT**  
**GM**



FIAT: Bravo/Brava, Barchetta, Coupe, Doblo Cargo, Idea, Marea/Weekend, Multipla, Siena, Palio/Weekend, Punto, Stilo  
Silniki benzynowe / Gasoline engine / Бензиновый двигатель:  
1.2; 1.4; 1.6; 1.8 16V  
Bravo/Brava, Cargo, Doblo, Ducato, Marea/Weekend, Multipla, Palio/Weekend, Punto, Scudo, Stilo, Ulysse, Dukato, Croma itd



Silniki diesla / Diesel engine / Дизельный двигатель:  
1.9D, 1.9TD, 1.9JTD, 2.4TD, 2.4JTD  
OEM: 1860847000 | 1860875000 | 1870697000 | 1860895000 | 1895879000 | 1860898000 | 1860992000 | 1860771000 | 1860161000 | 1860874000 | 1860876000 | 1860845000 | 1860876000 | 1860876000 | 1860910000 | 1860905010 | 1860987000 | 1860985000

Ref. 11-326 1/4 EAN 5907558436273



ALFA ROMEO: Mito (10-15)  
FIAT: 500 (07-15), 500C (07-15), Doblo/Cargo (05-10), Fiorino (09-15), Grande Punto (07-12), Idea (05-12), Linea (07-11), Panda/Panda Classic (09-13), Panda EVO2 (05-12), Punto EVO (09-12), Punto (12-15), Qubo (09-15), Seicento/600 (00-11)  
FORD: Ka (09-15)  
LANCIA: Musa (05-13), Ypsilon (06-15)



Kody silników / Engine codes / Коды двигателя:

Fi: 1.1 8v; 187A1.000, 1.2/1.2 Dualogic; 169A4.000, 188A4.000 (EVO2 only), 199A4.000, 1.4/1.4 Bi-Fuel LPG/1.4 Natural Power CNG; 199A7.000, 350A1.000  
Ford: 1.2 Duratec; 169A4.000(FP4)  
Lancia: 1.2 8v; 188A4.000, 1.4/1.4 Bi-Fuel LPG; 350A1.000  
OEM Ford: 303-1477 | 303-1478 | 303-1480 | 303-1479  
OEM Fiat: 2000004200 | 2190754200 | 2000004300 | 2000004400 | 2190754400 | 2191964400 | 2000004500 | 2190754500 | 2191964500 | 1860987000

Ref. 11-324 1/5 EAN 5907558436259





## Zestaw blokad rozrządu

Timing tool set / Nockenwellen-Arretierwerkzeugsatz / Набор фиксаторов распределвала для установки фаз ГРМ / Набор стопорів для розподілювальних валів / Vezérműtengely blokkoló készlet / Set de blocarea distribuției / Sada blokovací pro opravu rozvodů / Súprava blokad rozvodov / Set blokad gredi / Paskirstymo velenelių fiksavimo komplektas / Sadales mehānismu fiksatoru komplekts / Jaotuse blokeerimise komplekt / Комплект блокировки на газораспределительном валу / Set alata za blokiranje radilice / Pribor za blokadu razvođenja / Σετ συγκράτησης κινωδοφόρων αξόνων / Kit de bloqueo de la correa de distribución / Attrezzi di blocco dell'albero a camme / Conjunto de bloqueios de engranagem de distribuição / Set van distributievevergrendeling

NEO  
TOOLS



OPEL:  
Astra, Vectra B/C, Zafira, Signum, Frontera  
Silnik benzynowy/Gasoline engine:  
2.2 16V



Kody silników / Engine codes / Коды двигателя:  
ZZ2SE, ZZ2YH

Ref. EAN  
11-331 1/5 5907558436297

NEO  
TOOLS



OPEL:  
AGILA, ASTRA, CORSA, FRONTERA, OMEGA,  
SINTRA, VECTRA, TIGRA, ZAFIRA, (SAAB, RENAULT)



Silniki diesla / Diesel engine / Дизельный двигатель:  
1.3CDTI 16V, 1.9CDTI, 2.0 Di, 2.2DTI  
OEM: KM-952/09912-38310, KM-953/09919-58310,  
KM-954/09919-08310, KM-955/09919-58320, KM-  
6130

Ref. EAN  
11-330 1/2 5907558436280

NEO  
TOOLS



FORD:  
Focus, C-Max, Mondeo (2003-2010)



Silniki benzynowe / Gasoline engine / Бензиновый двигатель: 1.6 16V  
Kody silników / Engine codes / Коды двигателя: HXDA (2003-2007), HXJA, PNBA, RHBA,  
Silniki diesla / Diesel engine / Дизельный двигатель: 2.0 TDCi  
Kody silników / Engine codes / Коды двигателя: G6DA, G6DB, G6DC (2003-2007)  
OEM Ford: 303-1097 | 303-1054 | 303-1059 | 303-1270 | 303-748 | 303-735 | 303-1277 | 21-259 | 21-263  
OEM Peugeot: 0188X | 0187B | 0189B | 0188M | 0194B | 0132AJ1  
OEM Citroen 0188X | 0187B | 0189B | 0188M | 0194B | 0132AJ1  
OEM Renault: MOT1430  
OEM Volvo: 9997121 | 9997152 | 9997122

Ref. EAN  
11-335 1/10 5907558436334

NEO  
TOOLS



MAZDA: 1.4 1.8 2.0 2.4 2.5 TDCi, TD,  
Di, SCI  
FORD: Fiesta, Courier, Escort, Orion,  
Sierra, Mondeo, Focus, Transit,  
Tourneo, Fusion.



Silniki / Engines / Двигатели:  
Diesel: 1.4 TDCi, 1.8 D/TD, 1.8 Di, 1.8 TDCi, 2.0TD/TDCi, 2.4 D, 2.5 Di/Turbo/Tci  
Benzyna / Gasoline / Бензин: 1.8 Duratec - SCI  
Kody silników / Engine codes / Коды двигателя:  
C9DC, F9DA/B, C9DA/B, B9DA/B, B9PA, HCPA, FFDA, HCPB, P7PA, P9PA, R2PA, R3PA, RWPA, RFX, RFN, RKD, RTJ, RTK, 4EB,  
4EC, 4ED, 4FA, 4FB, 4FC, 4FD, 4GA, 4GB, 4GC, 4GD, 4GE, 4HB, 4HC  
OEM Mazda: 49 JE01 061  
OEM Ford: 21-162 | 21-162B | 303-367 | 303-376 | 23-059 | 310-085 | 21-168 | 303-393 | 23-020 | 23-047 | 23-020 | 21-163 |  
303-620 | 23-019 | 21-210 | 303-507 | 21-251 | 303-698 | 21-262 | 303-734 | 23-029 | 303-1061 | 23-058 | 310-084 | 21-105 |  
21-262 | 303-734 | 21-168 | 303-393 | 21-263 | 303-735  
OEM VAG: 3359 | T10008 | T10050 | 2065A

Ref. EAN  
11-333 1/4 5907558436310

NEO  
TOOLS



Chrysler Voyager (2001-2008)  
Chrysler Grand Voyager (2001-2008)  
Jeep Cherokee (2001-2008)  
LDV Maxus (2005-2008)



Kody silników / Engine codes / Коды двигателя:  
R2516C, R2516L, R2816K, VM2516L  
OEM: VM1052 | VM9660 | VM8873 | VM1080 |  
VM1068 | VM1089 | VM1053 Chrysler

Ref. EAN  
11-332 1/10 5907558436303

NEO  
TOOLS



FORD:  
Galaxy, Mondeo, S-Max, Focus 2010-



Silniki benzynowe / Gasoline engine /  
Бензиновый двигатель:  
2.0 SCTi EcoBoost/Ti-VCT  
Kody silników / Engine codes / Коды двигателя:  
TNWA / TNWB / TNBA / TPWA / MGDA / XQDA  
OEM: 303-748 | 303-1504 | 303-1565 | 303-1521

Ref. EAN  
11-336 1/5 5907558436341



## Zestaw blokad rozrządu

Timing tool set / Nockenwellen-Arretierwerkzeugsatz / Набор фиксаторов распределения для установки фаз ГРМ / Набор стопорів для розподільвальних валів / Vezérműtengely blokkoló készlet / Set de blocarea distribuției / Sada blokovací pro opravu rozvodů / Súprava blokad rozvodov / Set blokad gredi / Paskirstymo velenėlių fiksavimo kompleksas / Sadales mehānismu fiksatoru komplekts / Jaotuse blokeerimise komplekt / Комплект блокировки на газораспределении / Set alata za blokiranje radilice / Pribor za blokadu razvodjenja / Σετ συγκράτησης κωδικοφόρων αξόνων / Kit de bloqueo de la correa de distribución / Attrezzi di blocco dell'albero a camme / Conjunto de bloqueios de engrenagem de distribuição / Ensemble de verrouillage de distribution / Set van distributievevergrendeling

**NEO**  
TOOLS



FORD/CITROEN  
FIAT/JAGUAR  
LAND ROVER  
LDV/PEUGEOT



Ford: Mondeo (00-07), Transit (00-14)  
Citroen: Relay/Jumper III (06-13)  
Fiat: Ducato (06-11) : Ducato (06-11)  
Jaguar: X-Type (03-10)  
Land Rover: Defender Td4 (06-11)  
LDV: Convoy (02-06)  
Peugeot: Boxer III (06-12)



Kody silników / Engine codes / Коды двигателя:

2.00 Di/TD4i/TDCi: ABFA, D3FA, F3FA, D5BA, D6BA, F1FA, FMBA, FMBB, HJBA, HJBB, HJBC, HJBE, N7BA, N7BB  
2.20 TDCi/ECONetic: BG, CYFA, CYFB, CYFC, DRFA, DRFB, DRFC, P8FA, P8FB, PGFA, PGFB, QJBA, QJBB, QJBC, QJBD, QVFA, QVFB, SRFA, SRFB, SRFC, SRFD, SRFE, UHFA  
2.20 HDi/JTD:  
P22DTE (4HM), P22DTE (4HU), P22DTE (4HV)  
2.40 Di/TDCi: DOFA, D2FA, D2FB, D4FA, F4FA, FXFA, H9FA, H9FB, H9FD, JXFA, JXFC, PHFA, PHFC  
2.40 TD/Tdi:  
Z5D 424  
2.40 Td4:  
244DT  
0EM: 303-679A/21-238, 303-1151, 303-698/21-251, 303-675/21-234

Ref.	Icon	EAN
11-334	1/5	5907558436327

**NEO**  
TOOLS



**VOLVO**



VOLVO:  
Silniki benzynowe/gasoline engine: 4,5, 6 cylinder  
S80 (07-), V70 (08-), S80 (-06), XC90, V70 (00-08),  
V70 XC (01-) / XC70 (-07), S60, C30, C70 (04-), S40  
(04-), V50, S40 (-04), V40, 850, C70 Coupe (-05), S70,  
V70 (-00), V70 XC (-00), 960, S90, V90

Ref.	Icon	EAN
11-337	1/2	5907558436358

## Ściągacz uniwersalny

Universal pulley puller / Universalabzieher / Универсальный съёмник / Знімач универсальний / Univerzální agylehúzó / Extractor universal / Univerzální stahovák / Univerzálny stahovák / Univerzalni izvekač / Universalus nutraukiklis / Universālais novilcējs / Universaalne tōtmittis / Универсален събо за демонтаж / Univerzalni skidač / Univerzalna alatka za skidanje / Εξωλέκας γενικής χρήσης / Extractor universal / Estrattore universale / Extrator universal / Extracteur de poulie universel / Universele poelietrekker

**NEO**  
TOOLS

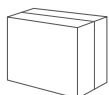

Ref.	Icon	EAN
11-299	1/10	5907558436044

## Nasadki do sondy lambda i wtryskiwaczy

Oxygen sensor and fuel injectors wrench set / Aufsätze für lambda-sonden und einspritzdüsen / Набор насадок для лямбда-зонды и форсунок / Насадки до лямбда-зонды и форсунок / Injector és lambdaszonda szerelő készlet / Ajutaj pentru sonda lambda și injectoare / Ключи на лямбда сонды а встřиковací trysky / Nástavce na lambda sondu a vstrekovače / Nasadni ključci za sonda lambda in injektorji / Galvučių rinkinys liambda zondui ir purkštukams / Lambda zondes un sprauslu uzgājī / Lambda sondi otsakud ja pihustid / Накрайници за лямбда сонда и за инжектори / Nasadni ključevi za lambda sondu ubrizgivača / Nastavci za sondu lambda i brizgalice / Σετ καρβύκια και ακροφύσια για αισθητήρα λямбда και εγχυτήρες / Casquillos para sonda lambda y para injector / Bussole per sonda lambda e iniettori / Bocais para a sonda lambda e injetores / Douilles pour sondes lambda et injecteurs / Doppen voor lambdasonde en inspuiters

**NEO**  
TOOLS



- 78 mm x 17, 19, 27, 28, 30 mm  
- 80 mm x 27 mm  
- 85 mm x 21 mm  
- 90 mm x 22 mm  
- 110 mm x 27 mm

Nasadka sześciokątna 1/2" do sondy lambda / 6 point socket 1/2" for oxygen sensors / Головка 6-гранная 1/2" для лямбда-зонды:

- 80 mm x 20 mm  
Nasadki odjęte do sondy lambda / Offset sockets for oxygen sensors / Головки для лямбда-зонды:

- 31 mm x 22 mm x 3/8"  
- 50 mm x 22 mm x 1/2"

Nasadki dwunastokątne 1/2" do wtryskiwaczy / 12 point sockets 1/2" for diesel injectors / Головки 12-гранные для форсунок:

- 110 mm x 22 mm  
- 150 mm x 22 mm

Ref.	Icon	EAN
11-880	0/5	5907558436877

**NEO**  
TOOLS



Nasadki dwunastokątne 1/2" do sondy lambda / 12 point sockets 1/2" for oxygen sensors / Головки 12-гранные для лямбда-зонды:

- 78 mm x 22, 28 mm  
- 80 mm x 27 mm

Nasadka sześciokątna 1/2" do sondy lambda / 6 point socket 1/2" for oxygen sensors / Головка 6-гранная 1/2" для лямбда-зонды:

- 90 mm x 29 mm  
Nasadki sześciokątna 3/8" do sondy lambda / 6 point sockets 3/8" for oxygen sensors / Головка 6-гранная 3/8" для лямбда-зонды:

- 74 mm x 27 mm  
- 80 mm x 22 mm  
- 90 mm x 22 mm

Odjęte nasadki do sondy lambda / Offset sockets for oxygen sensors / Головки для лямбда-зонды:

- 31 mm x 22 mm x 3/8"  
- 50 mm x 22 mm x 1/2"

Nasadka dwunastokątna 1/2" do wtryskiwaczy / 12 point socket 1/2" for diesel injectors / Головка 12-гранная 1/2" для форсунок:

- 108 mm x 22 mm

Ref.	Icon	EAN
11-882	0/5	5907558436891

## Klucze nasadowe do sondy lambda

Oxygen sensor socket wrench / Aufsatzschlüssel für lambda-sonde / Торцевые головки для лямбда-зонды / Ключи торцеві до лямбда-зонды / Lambdaszonda szerelő készlet / Chei tubulare pentru sonda lambda / Nástrčné klúče pro sondy lambda / Nástavcové klúče na lambda sondu / Nasadni ključci za sonda lambda / Galvutės liambda zondui / Muciņatslēgas liambda zondei / Lambda sondi vōti / Ключови накрайници за лямбда сонда / Nasadni ključevi za lambda sondu / Ključ natičak za sonda lambda / Καρβύκια για αισθητήρα λямбда / Llave de vaso para sonda lambda / Set di bussole per sonda lambda / Chaves articuladas para a sonda lambda / Clé à sonde lambda / Dopsleutels voor lambdasonde

**NEO**  
TOOLS



1/2" x 29 x 90 mm (wycięcie 8 mm)  
1/2" x 27 x 80 mm  
3/8" x 7/8" x 90 mm (wycięcie 20 mm)  
3/8" x 1-1/16" x 74 mm  
3/8" x 7/8" x 80 mm  
1/2" x 22 x 50 mm  
3/8" x 22 x 31 mm

Ref.	Icon	EAN
11-881	0/10	5907558436884



## Klucze nasadowe do sondy lambda

Oxygen sensor socket wrench / Aufsatzschlüssel für lambda-sonde / Торцевые головки для лямбда-зонды / Ключи торцевой до лямбда-зонды / Lambdasonda kulcs készlet / Chei tubulare pentru sonda lambda / Nástrčné kľúče pro sondy lambda / Nástavcové kľúče na lambda sondu / Nasadni ključji za sonda lambda / Galvutės liambda zondui / Muciņatslēgas lambda zondei / Lambda sondi vōti / Ключови накрайници за лямбда сонда / Nasadni ključevi za lambda sondu / Кључи натикач за сонде lambda / Καρυδάκια για αισθητήρα λямбда / Llave de vaso para sonda lambda / Set di bussole per sonda Lamda / Chaves articuladas para a sonda lambda / Clé à sonde lambda / Dopsleutels voor lambdasonde

**NEO**  
TOOLS



Otkienka w nasadkach pozwalają na montaż bez demontażu przewodów  
Nasadki pasują do popularnych aut osobowych poruszających się po europejskich drogach  
Open-sided for lambda probe fitting without the removal of cables  
The sockets fit popular European cars

Діючі в голівках дозволяють проводити монтаж без демонтажу проводів  
Голівки підійдуть популярним легковим автомобілям на європейських дорогах

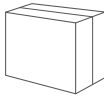

Nasadka końcowej sondy lambda (gorącej) / The socket for end lambda probes (hot) / Голівка для кінцевих лямбда-зондів (гаряча) 1/2", 22 mm x 50 mm  
Nasadka czujnika podciśnienia i sondy lambda (do sond nisko osadzonych) / The socket for end lambda probes (hot) / Голівка вакуумного датчика і лямбда-зондів (для низько посаджених зондів) 3/8", 22 mm x 30 mm  
Nasadka czujnika podciśnienia i sondy lambda / The socket for vacuum sensor and lambda probe / Голівка вакуумного датчика і лямбда-зондів 3/8", 22 mm x 80 mm

Ref.	⊠	EAN
11-203	0/20	5907558416763

## Klucz do sondy lambda

Oxygen sensor socket wrench / Schlüssel für lambda-sonde / Ключ для лямбда-зонды / Ключ до лямбда-зонды / Lambdasonda kulcs, rövid / Cheie pentru sonda lambda / Kľúč na lambda sondy / Kľúč na lambda sondu / Kļuč za sonda lambda / Raktas liambda zondui / Lambda zondes atslēga / Lambda sondi vōti / Ключ за лямбда сонда / Кључ за sonda lambda / Кључ за sonda lambda / Кључи за sonda lambda / Set di bussole per sonda Lamda / Chave para a sonda lambda / Clé à sonde lambda / Sleutel voor lambdasonde

**NEO**  
TOOLS

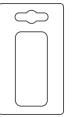

Nasadka do długich sond lambda i tam gdzie złącze przewodów nie pozwala na zastosowanie typowej nasadki do sond ze szczeliną  
The socket is suitable for long lambda probes and wherever cable connectors do not allow for using typical probe sockets with a gap  
Голівка для довгих лямбда-зондів і там, де кабельний роз'єм не дозволяє використовувати типову голівку для лямбда-зондів з зазором

Ref.	W [mm]	⊠	EAN
11-204	22	10/100	5907558416749

**NEO**  
TOOLS



Nasadka do krótkich sond lambda  
The socket is suitable for short lambda probes  
Голівка для коротких лямбда-зондів



Ref.	W [mm]	⊠	EAN
11-205	22	10/50	5907558416756

## Ściągacze do wtrysków z młotkiem bezwładnościowym

Fuel injector extractor service set / Abzieher für Einspritzungen mit Trägheitshammer / Комплект для снятия дизельных форсунок с обратными молотками / Комплект знімачів форсунок зі зворотним молотками / Befestigendzöfj kihúzó készlet csúszo kalapáccsal / Instalații de decapare pentru injectări cu ciocan inertial / Sada na vstřikovače s reverzním kladivem / Sťahovčky vstrekačov so zotrvačným kladivom / Izvlekači za injektorje z inercijskim kladivom / Dizelinių purkštukų nuėmimo komplektas su atbuliniu plaktuku / Dizela sprauslu noņēmjēju komplekts ar inerces āmuru / Kütusepühusti tõmmitsad, inertshaamriga / Инструмент скоба обратен чук за вадене на дюзи / Skidači za ubrizgivače s inercijskim čekićem / Komplet atlatki za skidanje mlaznica sa inercijalnim čekićem / Σετ εξαγωγής ακροφυσίων εγκυτήρα νιζέζη με σφαιρία αλιείας, κεφαλές / Extractores para inyección con martillo de inercia / Estrattori per iniettori con martello inerziale / Fresas para limpeza de encaixes de injetores / Kit extracteur injection diesel avec marteau coulissant / Injectietrekkers met glijhamer

**NEO**  
TOOLS

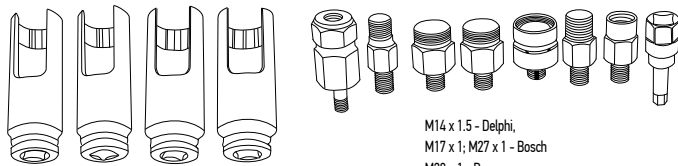

25, 27, 29, 30 x 100 mm

M14 x 1.5 - Delphi,  
M17 x 1; M27 x 1 - Bosch  
M20 x 1 - Denso,  
M24 x 1; M27 x 1 - Siemens,  
M14 x 1.5P

**NEO**  
TOOLS



1.6 kg / 160 mm  
2.7 kg / 460 mm  
5.1 kg / 600 mm

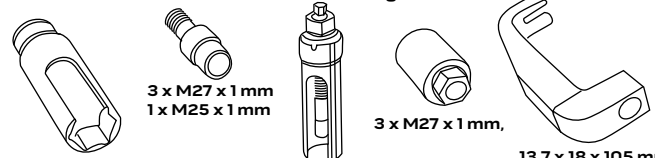

25, 27, 28, 29, 30 x 100 mm 35 x 29 mm / M17 x 1 mm 13.7 x 18 x 105 mm 12.7 x 19 x 135 mm



Ref.	⊠	EAN
11-883	1/2	5907558435405



Ref.	⊠	EAN
11-884	1/1	5907558435412



## Frezy do czyszczenia gniazd wtryskiwaczy

Diesel injector seat cleaning / Fräsen zur Reinigung von Einspritzungsbuchsen / Набор для чистки посадочных мест дизельных форсунок / Набор для чищення посадкових місць дизельних форсунок / Injektor fészek maró és tisztító készlet / Freze pentru curățarea prizelor injectoarelor / Frézy na čištění sedel vstřikovačů / Frézy na čistenie zásuviek vstrekovačov / Orodje za čiščenje ležišč injektorjev / Dyzelinių purkštukų lizdų valymo įrankių rinkinys / Dizela sprauslu ligzdu tīrītāji / Pihustipesade puhastamise freesid / Фрезы за почистване на леглото на инжектору / Set za čiščenje priključka ubrizgivača / Pribor za čiščenje utičnica ubrizgivača / Σετ καθαρισμού υποδοχών ακροφυσίων εγχυτήρα ντίζελ / Fresas para la limpieza de las tomas de los inyectores / Frese per la pulizia delle sedi degli iniettori / Fresas para limpeza de encaixes de injectores / Kit de nettoyage pour sièges d'injecteurs / Freesstukken voor reiniging van injectie nesten

NEO  
TOOLS



14 x 14 mm, 15 x 19 mm, 15.5 x 15.5 mm, 17 x 17 mm, 17 x 17.5 mm, 17 x 19 mm, 17 x 19.5 mm, 17 x 20 mm, 19 x 21.5 mm



15.5 x 15.5 mm, 17 x 17 mm, 17 x 21 mm, 17.5 x 20.5 mm



NEO  
TOOLS

CrV  
steel

x4



Frez do gniazd zaworowych diesel. Zawartość: frez 15 mm płaski frez uniwersalny, 17 mm frez płaski dla wtryskiwaczy, Delphi/Bosch (BMW/PSA/Renault/Ford), 19 mm Frez płaski dla wtryskiwaczy Bosch (Mercedes CRD), 19 mm Frez kątowy dla wtryskiwaczy Fiat/Iveco, Trzpień pilotujący 19 mm HEX

Diesel injector seat cutter set 4 pcs. Edge trimming cutter 15 mm flat, universal, 17 mm flat for Delphi/Bosch injectors (BMW/PSA/RENAULT/FORD), 19 mm flat for Bosch injectors (Mercedes CRD), 19 mm angle edge trimming cutter for FIAT/IVECO, Pilot mandrel 19 mm HEX

Фреза для чистки седел дизельных форсунок. В комплекте: плоская фреза 15 мм - универсальное применение, 17 мм плоская фреза для Delphi/Bosch (BMW/PSA/Renault/Ford), 19 мм плоская фреза для Bosch (Mercedes CRD), 19 мм угловая фреза для Fiat/Iveco, держатель-направляющая 19 мм HEX

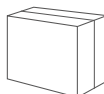

Ref.	📦	EAN
11-218	0/20	5907558420401

Ref.	📦	EAN
11-885	1/5	5907558435429

## Zestaw do centrowania tarcz sprzęgła

Clutch center set / Zentriersatz für Kupplungsscheiben / Универсальный набор для центровки дисков сцепления / Набор універсальний для центрування дисків зчеплення / Kuplungtárca központosító készlet / Trusa de centrare a discurilor de ambreiaj / Sada pro centrování spojkových kotoučů / Centrovacia súprava kotúčov spojky / Kľuč za centriranje plošč sklopke / Sankabos diskų centravimo rinkinys / Sąjūga disku centrėšanas instrumentu universālais komplekts / Siduriketaste tsentreerimise komplekt / Комплект за центровка на съединители / Set za centriranje ploča spojke / Pribor za centriranje diskova kvačila / Σετ κεντραρίσματος δίσκων συμπλέκτη / Kit de centrado de la placa de embrague / Kit per il centraggio del disco frizione / Kit de centragem de discos de embraiagem / Kit de centrage pour disques d'embrayage

NEO  
TOOLS



11, 12, 15, 17, 19, 20, 21, 25 mm



NEO  
TOOLS



Volvo: C30, C70 (06->), S40 (04->), S60 (11->), S80(07->), S80L, V40 (13->), V40 Cross Country, V50, V60, V70(08->), XC60 Ford: Focus(04->), C-Max, S-Max, Galaxy, Mondeo (07->), Kuga (13->), zamiennik / replacement / заміна OEM: Volvo 9997435, Ford 308-763



Ref.	📦	EAN
11-170	1/10	5907558437348

Ref.	📦	EAN
11-171	1/4	5907558437379



## Szcypce do opasek

Clamp pliers / Zange für Kraftstoffleitungen / Щипцы для хомутов / Щипцы для шлангов / Bilincsfogó / Clește / Klešče na spony / Kliešte na hadicové spony / Klešče za vzmetne objemke / Replés žarnelių žiedų užspaudimui / Savilježju knaibles / Kaablisidemet tangid / Щипцы за проводниці на горювото / Klijesta za stiskanje / Klešta za žicu / Λαβίδα στεφανιών στερέωσης / Alicates para bridas / Pinza per morsetti in gomma / Pinças para abraçadeiras / Pince de serrage

**NEO**  
TOOLS

Do opasek sprężynujących na przewodach olejowych i wodnych etc.  
Do pracy w miejscach trudnodostępnych  
Długość giętkiej części: 630 mm, długość części z rękojścią: 210 mm  
Zasięg ścisisku: 0 – 45 mm

For spring clips on oil and water hoses  
For difficult to reach places

Flexible section length: 630 mm, handle section length: 210 mm  
Clamping range: 0 – 45 mm

Для пружинних хомутів паливних, масляних і водяних шлангів і т.д.  
Для роботи у важкодоступних місцях  
Довжина гнучкої деталі: 630 мм, довжина деталі з рукою: 210 мм  
Діапазон затиску: 0 – 45 мм

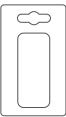

Ref.	W [mm]	⊠	EAN
11-221	840	6/36	5907558416602

**NEO**  
TOOLS



Ref.	⊠	EAN
11-222	0/54	5907558418545

**NEO**  
TOOLS



Ref.	⊠	EAN
11-223	6/48	5907558418552

## Szcypce zaciskowe z tworzywa

Flexible line clamp / Gripzange aus Kunststoff / Набор зажимов с фиксатором / Кліщі дещільні пластикова / Őnzáró fogókészlet műanyag / Clește de strângere din plastic / Plastové svěrací klešče / Zvieracie plastové kliešte / Plastične klešče za preščaj cevi / Replés stabdžiu šlangelėms užspausti / Plastmasas saspieššanas knaibles / Plastist lukustustangid / Стягазаци клеци от пластмаса / Stezna klijesta od umjetnog materijala / Plastična klešta / Σετ σφρυγγήρες με μηχανισμό ασφαλίσης / Tenazas abrazaderas de plástico / Pinza occlusion tubo in plastica / Pinças de plástico / Pince de serrage en plastique / Krimptang van kunststof

**NEO**  
TOOLS

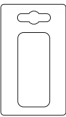

Ref.	⊠	EAN
11-224	0/48	5907558418699

**NEO**  
TOOLS



Ref.	⊠	EAN
11-228	1/5	5907558437386

**NEO**  
TOOLS



Ref.	⊠	EAN
11-226	6/60	5907558420197

## Zestaw mini szczypec do pierścieni osadzczych

Mini pliers set for circlips / Mini-Zangenset für Stellringe / Набор щипцов для стопорных колец, "mini" / Набор мини-щипцов до стопорных колець / Mini pliers set for circlips / Garnitura de mini clesti pentru inele de strangere / Sada preciznich kleštů na pojistné kroužky / Súprava mini klieštů na poistné krúžky / Set mini klešč za objemke / Mini replij komplektas, fiksavimo žiedams / Sprostgredzenu knaibļu komplekts, mini / Lukustusrõngaste minitangide komplekt / Комплект мини щипцы за стопорни пръстени / Set mini seger klijesta za stiskanje i širenje / Komplet mini klešta za talažne prstene / Σετ μικρές λαβίδες για δακτύλια ασφαλείας / Juego de mini alicates para anillos de retención / Kit mini pinze per anelli d'arresto / Pinças para anéis / Jeu de mini-pinces pour colliers de fixation / Set van mini tangen voor dopringen

**NEO**  
TOOLS

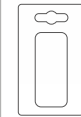

Ref.	⊠	EAN
11-227	24/48	5907558420395



## Zaciskacz do pierścieni

Piston ring compressor / Ringklemme / Оправка поршневых колец / Затискач до кілець / Dugattyúgyűrű szerítő szalag / Strängåtor de inele / Svērka na kroužky / Pás na sťahovanie piestných krúžkov / Obročni prižemnik / Žiedų suspaudėjas / Gredzenu spasiėdėjis / Vārusulgur / Стяга за пръстени / Stezaljka za prstenje / Stezač za prsten / Συμπιεστής βακτηλιών εμβόλου / Compresor para anillos / Morsetto per anelli / Fixador de anéis / Colier de serrage / Ringklem

NEO  
TOOLS

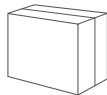
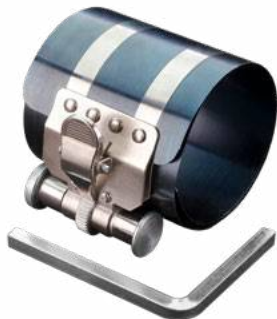

Ref.	Ra [mm]	☒	EAN
11-250	50 - 125	0/60	5907558418330

## Klucz do demontażu napinaczy z wymiennymi końcówkami

Tensioner pulley / Schlüssel zum Abbau von Spannern mit austauschbaren Spitzen / Ключ для снятия переднатяжителей со сменными наконечниками / Ключ для зняття переднатягувачів зі змінними наконечниками / Feszítőörgő kulcs cserélhető fejekkel / Cheie pentru demontarea întinzătoarelor cu capete interschimbabile / Ključ na demontáž napínací kladky s vyměnitelnými koncovkami / Kľúč na odstraňovanie napínačov s vymeniteľnými hrotmi / Kľuč za odstranitev zategovalnikov z izmenljivimi konicami / Raktas įtempiklių nuėmimui, su keičiamais antgaliais / Priekšspriegotāja demontāžas atslėga ar maiņas uzgaļiem / Pingūtiie eemaldamise vōti, vahetatavate atsakutega / Ключ за демонтiranje на обтяжени ролки със сменяеми накрайници / Kľuč za demontažu zatezača sa izmenljivim nastavcima / Kľuč za demontiranje zatezača sa promenljivim krajevima / Кλειδι αφαιρέσης προεντατήρων με αναλλακτικές μύτες / Llave para quitar los tensores con puntas intercambiables / Chiave per smontaggio dei tenditori con punte intercambiabili / Chave para desmontar tensores com pontas substituíveis / Clé de démontage des détracteurs avec embouts interchangeables / Sleutel voor demontage van spanners met eindstukken

NEO  
TOOLS

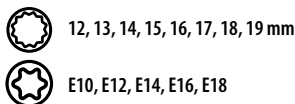

Ref.	☒	EAN
11-169	0/10	5907558437331

## Klucz do napinania pasków klinowych

Transmission belt tensioning wrench / Schlüssel zum Spannen von V-Spanngurten / Ключ для затягування клинових ремней / Ключ для зтягування клинових пасів / Ékszjű feszítő kulcs / Cheie pentru strângerea curelei trapezoidale / Ključ k napínání řemenice / Kľúč na uťahovanie klinových remeňov / Kľuč za napenjanje klinastega jermena / Pleištiņņu diržų užveržimo raktas / Transmisijas siksnas pievilksanas atslėga / Kiliirihmade pingutamine vōti / Инструмент за натягане на клинов ремень / Kľuč za naprezanje remena / Kľuč za zatezanje klinastih remenova / Кλειδι τάνυσης σφηνοειδών ψάντων / Llave para apretar las correas / Chiave per il tensionamento di cinghie dentate / Chave para tensionar correias / Clé pour tendre des courroies / Spanner voor V-snaar

NEO  
TOOLS



40-200  
mm



Ref.	☒	EAN
11-168	1/6	5907558437324

## Zestaw do alternatora

Combined sockets for alternator / Lichtmaschinen-Schlüsselsatz / Набор для альтернатора / Набор до генератора змінного струму / Készlet generátor szereléshez / Set de alternator / Sada na alternátor / Súprava pre alternátor / Set za alternator / Rinkiny kintamosios srovės generatoriui / Mainstrāvas ģeneratora instrumentu komplekts / Generatori padrunvōtmete komplekt / Комплект за альтернатора / Garnitura za alternator / Garnitura za alternator / Σετ για εναλλακτήρα / Juego para alternador / Kit per montaggio e smontaggio alternatori / Jogo de acessórios para alternador / Kit d'alternateur / Set voor wisselstroomgenerator

NEO  
TOOLS

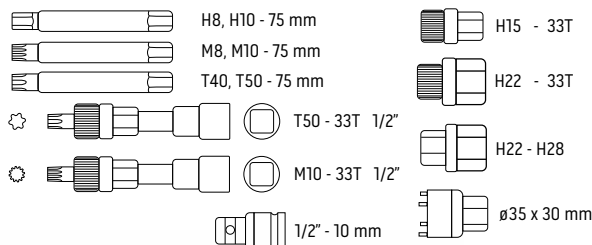

Ref.	☒	EAN
11-167	1/10	5907558437317

## Zestaw do układów cieżnienia/podciężnienia

Tester for vacuum and pressure systems / Satz für Druck-/Vakuumsysteme / Набор для напорних / вакуумних систем / Набор для напорних/вакуумних систем / Vákuum és nyomás tesztelő / Set pentru sisteme de presiune / vid / Tester pro tlakové/podtlakové systémy / Súprava pre tlakové / podtlakové systémy / Set za vakuumske in tlačne sisteme / Rinkiny slėgio / vakuumo sistemoms / Spiediena/ vakuuma sistēmu instrumentu komplekts / Rōhu-/vakuumsūsteemide komplekt / Πομπα за тестване на вакуум и налягане / Set za sustave tlaka/podtlaka / Pribor za sistem priiška/vakuuma / Σετ για συστήματα κενού αέρος/παροχής υπό πίεση / Probador de sistemas de presión / vacío / Kit per impianti a pressione/in depressione / Kit para sistemas de pressão/subpressão / Testeur de pression / compression / Meter voor druk/onderdruk systemen

NEO  
TOOLS

-1÷3  
BAR



Ref.	☒	EAN
11-267	1/10	5907558436013



## Zestaw do diagnostyki systemów Common Rail

Common Rail diagnostic set / Diagnosissatz für Common-Rail-Systeme / Набор для диагностики систем Common Rail / Набор для диагностики систем комон-рэйл / Common rail rendszer diagnosztikai készlet / Trusă pentru diagnosticarea sistemelor Common Rail / Sada pro diagnostiku systémů Common Rail / Sada pre diagnostiku systémov Common Rail / Set za diagnostiku sistemov Common Rail / Diagnostikos rinkinys, skirtas sistemai Common Rail / Common Rail sistėmu diagnosticėšanas komplekts / Common Rail sistėmide diagnostikakomplekt / Комплект за диагностика на систему Common Rail / Set za dijagnostiku sustava Common Rail / Pribor za dijagnostiku sistema Common Rail / Διαγνωστικό σετ για αυστήματα Common Rail / Set para diagnóstico de sistemas Common Rail / Kit diagnostico per sistemi Common Rail / Kit de diagnóstico de sistemas Common Rail / Kit de diagnostic pour systèmes Common Rail / Common Rail diagnostische set

**NEO**  
TOOLS



BOSCH  
SIEMENS  
DENSO  
DELPHI



Ref. 11-263  
1/5  
EAN 5907558435979

## Zestaw do testowania systemów wtryskowych

Fuel injection injector pressure test set / Testsatz für Einspritzsysteme / Набор для проверки форсунки впрыска топлива / Набор для перевірки форсунок вприскування палива / Befestekendő rendszer tesztelő készlet / Set pentru testarea sistemelor de injectie / Sada pro testování vstřikovacíh systémů / Súprava na testovanie vstrekovacích systémov / Set za testiranje injektorskih sistemov / Įpurškimo sistemų testavimo rinkinys / Degvielas iesmidzināšanas sprauslas pārbaudes instrumentu komplekts / Sissepritseüsteemide testimise komplekt / Комплект за диагностика на инжекционни системи / Set za ispitivanje sustava ubrizgivanja / Sistem za testiranje sistema za ubrizgavanje / Σετ ελέγχου ακροφυσίου έγχυσης καυσίμου / Kit para pruebas de sistemas de inyección / Kit per il test di sistemi di iniezione / Kit de testagem de sistemas de injeção / Kit d'essai pour systèmes à injection / Brandstofinjectie test set

**NEO**  
TOOLS



0-10  
BAR

Ref. 11-264  
1/5  
EAN 5907558435986

## Miernik ciśnienia sprężania

Compression tester / Verdichtungsdruckmesser / Компрессометр бензиновый / Компресометр / Kompresszió mérő készlet / Aparat de măsurat compresia / Měřicí přístroj kompresního tlaku / Merač kompresného tlaku / Merilec pritiska adapter / Kompresijos matuoklis / Kompresijos manometrs / Manometer adapterite komplekt / Компресометр / Mjerač pritiska / Merač pritiska sabijanja / Συμπιεσόμετρο βενζίνης / Medidor de aire comprimido / Misuratore della compressione / Medidor de pressão de compressão / Compressiometre compression / Meter van persdruk

**NEO**  
TOOLS

70  
BAR x16  
DIESEL



Miernik kompresji do pomiarów ciśnienia sprężania w cylindrach silników wysokoprężnych (diesla)  
Zestaw zawiera różne adaptery pasujące do większości silników aut osobowych i dostawczych  
Maksymalny zakres pomiaru – 70 barów  
Pressure gauge for measuring compression pressure in diesel engine cylinders  
The set includes various adapters suited for a majority of passenger and delivery vehicle engines  
The maximum measurement range – 70 bars  
Компресометр для вимірювання тиску в дизельних двигунах  
Включає адаптери, які підходять для більшості двигунів автомобілів і вантанівок  
Діапазон вимірювального тиску – до 70 бар

Ref. 11-262  
0/6  
EAN 5907558416732

**NEO**  
TOOLS

21  
BAR



Miernik kompresji do pomiarów ciśnienia sprężania w cylindrach silników spalinyowych benzynowych  
Zestaw zawiera adapter pasujący do większości silników aut osobowych i dostawczych  
Maksymalny zakres pomiaru – 21 barów  
Compression pressure gauge for measuring compression pressure in petrol combustion engine cylinders  
The set includes an adapter suited for a majority of passenger and delivery vehicles  
The maximum measurement range is – 21 bars  
Компресометр для вимірювання тиску в бензинових двигунах  
Включає адаптер, який підходить для більшості двигунів легкових і вантанічних автомобілів  
Діапазон вимірювального тиску – до 21 бар

Ref. 11-261  
0/20  
EAN 5907558416725



## Tester ciśnienia turbosprężarki

Turbo pressure gauge / Druckprüfgerät für Turbolader / Тестер турбо давления / Тестер тиску у турбокомпресорі / Turbófeltöltő nyomás tesztelő / Tester de presiune turbocompresor / Manometr pro kontrolu tlaku turba / Tester tlaku turbodúchadla / Preskuševalnik tlaka turbo kompresorja / Turbokompresorij testavimo rinkinys / Turbo spiediena mēritājs / Turbolaaduri rõhu tester / Тестер за налягане на турбокомпресор / Tester pritiska u turbokompresoru / Tester za pritisak turbokompresora / Ελεγκτής πίεσης turbo / Probador de presión para turbocompresor / Tester di pressione per turbocompressori / Aparelho de teste de pressão de turbocompressor / Testeur de pression d'huile turbocompresseur / Turbocompressor druk meter

NEO  
TOOLS



-1÷3  
BAR

Ref. EAN  
11-265 1/10 5907558435993

## Tester ciśnienia oleju

Engine oil pressure tester / Druckprüfgerät für Öldruck / Тестер давления масла / Тестер тиску оливи / Olajnyomás tesztelő / Tester de presiune ulei / Tester tlaku oleje / Tester tlaku oleja / Preskuševalnik tlaka olja / Tepalo slégio matuoklis / Είλας spiediena mēritājs / Ölirõhu tester / Тестер за налягането на маслото / Tester pritiska ulja / Tester za pritisak ulja / Ελεγκτής πίεσης λαδιού / Probador de presión del aceite / Tester di pressione dell'olio / Aparelho de teste de pressão de óleo / Testeur de pression d'huile / Motorolie druk meter

NEO  
TOOLS



0-10  
BAR



Ref. EAN  
11-266 1/2 5907558436006

## Zestaw kluczy nasadowych do filtra oleju

Car type oil filter wrench set / Steckschlüsselsatz für Ölfilter / Набор торцовых ключей к масляному фильтру / Набор накидных ключів до олійного фільтру / Dugókulcs-készlet olajsűrűhöz / Set de chei tubulare pentru filtru de ulei / Sada miskovitých klíčů na olejové filtry / Súprava nástavcových klíčův na olejový filter / Set nasadnih ključev za oljni filter / Galvučių rinkinys tepalo filtrui / Eίλας filtra mucipnatslėgu kompleks / Ölifiltri radruvõtmete komplekt / Комплект гаечни ключове за масления филтър / Garnitura nasadnih ključeva za filter ulja / Garnitura ključeva natikača za filtere za ulje / Σετ μπουλονόκλειδα για φίλτρο λαδιού / Juego de llaves de vaso para filtro de aceite / Completo di chiavi a bussola per il filtro dell'olio / Jogo de chaves tubulares para filtro de óleo / Jeu de clés à douille pour filtre à huile / Set van dopsleutels voor oliefilter

NEO  
TOOLS

x30



NEO  
TOOLS

x16



	Ø mm	N	
66/6	66	6	Fiat Punto 1.2; Renault Clio1.2, Rapid, Twingo
65/14	65	14	Daihatsu; Toyota; Nissan; Fiat; Camry
65/67	65-67	14	Daihatsu; Toyota; Mazda; Mitsubishi
68/14	68	14	Mazda; Ford; Subaru; Toyota
73/14	73	14	Toyota; Lexus
74/15	74	15	Audi; Rover; Chrysler; Lexus; GM
74/76	74-76	15	Ford; Opel; VW; Audi; Mercedes; GM
75/77	75-77	15	VW; Audi; Isuzu; Mercedes; GM; Chrysler
76/12	76	12	Fiat; Mercedes; Renault
76/14	76	14	VW; Porsche; Mercedes; BMW; Audi; Opel; Buick
76/30	76	30	Ford; VW; Renault; Peugeot
76/8	76	8	Fiat; Lancia
78/15	78	15	Nissan; Ford; Toyota
80/15	80	15	Nissan; Honda; Opel; Mazda; Iveco

	Ø mm	N	
80/82	80	15	Subaru; Toyota; Honda; Nissan; Iveco; Hyundai; Mazda
86/16	86	16	Volvo
86/18	86	18	VW Golf; Audi A6 TDI; Peugeot; Citroen
90/15	90	15	Honda; Mitsubishi; Isuzu; Mazda
92/10	92	10	Fiat
93/15	93	15	Mazda; Volvo; Mitsubishi; Nissan; Honda
93/36	93	36	Ford; Audi
93/45	93	45	VW; Audi TDI
95/15	95	15	Toyota; Alfa Romeo; Ford
96/18	96	18	Audi A4; A6 TDI; VW Passat TDI; Renault Laguna
100/15	100	15	Isuzu; Mitsubishi; Buick; Hyundai; Iveco; Daewoo; Renault
106/15	106	15	Fiat Ducato
108/15	108	15	Volvo
108/18	108	18	Renault Espace; Laguna; Safrane; Traffic

Ref. EAN  
11-242 66-108 1/2 5907558435955

Ref. EAN  
11-243 65-100 1/10 5907558435962





## Nasadka do filtra oleju

Sup type oil filter wrench / Ölfilterkappen / Съемник масляного фильтра "чашка" / Знімач масляного фільтра "чашка" / Csésze olajsűrő lehúzó / Supř filtru de ulei / Stahovák olejového filtru / Ključ na olejovj filter / Ključ za oljni filter / Raktas tepalo filtrui / Atslēga eļļas filtram / Ölilfitri vöü / Водеца шина за дрза / Ključ za uljni filter / Ključ za uljani filter / Κλειδί φίλτρου λαδιού / Llave para filtro de aceite / Chiave per il filtro dell'olio / Chave p. filtros de óleo / Clef à filtre d'huile / Sleutel voor oliefilter

NEO  
TOOLS



3/8"

Ref.	Ø mm	N	⊠	EAN
11-360	76	12	10/60	5907558445299
11-361	65	14	10/60	5907558445305
11-362	67	14	10/60	5907558445312
11-363	73	14	10/60	5907558445329
11-364	76	14	10/60	5907558445336
11-365	74	15	10/60	5907558445343
11-366	78	15	10/60	5907558445350
11-367	80	15	10/60	5907558445367
11-368	90	15	10/60	5907558445374
11-369	95	15	10/60	5907558445381
11-370	108	15	10/60	5907558445398
11-371	86	16	10/60	5907558445404
11-372	86	18	10/60	5907558445411
11-373	96	18	10/60	5907558445428

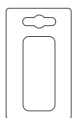

## Zestaw do misek oleju

Oil change tool kit / Ölwechsel-Werkzeugsatz / Набор инструментов для замены масла / Набор інструментів для заміни масла / Különleges szerszámkészlet olajcseréhez / Trusă de scule specială pentru schimbul de ulei / Speciální sada náradí pro výměnu oleje / Speciálna sada náradia na výmenu oleja / Orodje komplet posebnih za menjavo olja / Įrankių rinkinys specialus alyvos keitimui / Įrašs instrumentu komplekts eļļas maiņai / Тööriistakomplekt spetsiaalne õlivahetuseks / Комплект инструментов за смяна на масло / Komplet alata poseban za zamjenu ulja / Комплект алата спеціални за замену уља / Είδικό kit εργαλείων για αλλαγή λαδιού / Kit de herramientas especial para cambio de aceite / Kit attrezzi speciali per cambio olio / Kit de ferramentas especial para troca de óleo / Kit d'outils spécial pour le changement d'huile

NEO  
TOOLS



5  
ELEMENTS

1/4"

3/8"



Audi / SEAT / Škoda / VW:  
model year 2013 with 1.2 · 1.4 · 1.8 · 2.0 l TFSI petrol engines  
Audi: A1, A3, A4, A5, Q5  
VW: Golf 7  
SEAT: Leon, etc. with 1.6 and 2.0 l diesel engines



OEM: Connect 31775 Peugeot/Citroen (OEM 9801444780 Plug) and Ford (OEM 18711598 plug) Connect 31776 Ford (OEM 1830727 plug) Connect 31774 BMW (OEM 11137605018 plug) Connect 31771 VAG (OEM 06L 103 801 sump and cam cover plug)



Ref.	⊠	EAN
11-384	5/20	5907558452273

## Końcówka wkrętakowa do korków oleju

Special bit for oil drain plug / Spezial Bit für Ölablassschraube / Бита специальная для сливной пробки / масляного под / Бита для сливной пробки / Bit az olajdugókhöz / Bit special pentru dopul de scurgere a uleiului / Speciální bit pro vypouštění zátku oleje / Špeciálny bit pre vypúšťacíu zátku oleja / Poseben bit za zamašek za izpust olja / Specialus antgalis alyvos išleidimo kamščiai / Įrašs bit eļļas iztukšošanas aizbāžnei / Spetsiaalne ots õli väljalaskekrui jaoks / Ключ за маслену тату / Ključ za čepove za ulje / Ключ за чепове за уље / Κλειδί για βύαματα λαδιού / Llave especial tapón de aceite / Chiave speciale per tappi olio / Chave especial para óleo / Clé à bouchon d'huile spéciale / Speciale olieplugsleutel /

NEO  
TOOLS

1/4"



Audi / SEAT / Škoda / VW:  
model year 2013 with 1.2 · 1.4 · 1.8 · 2.0 l TFSI petrol engines  
Audi: A1, A3, A4, A5, Q5  
VW: Golf 7  
SEAT: Leon, etc. with 1.6 and 2.0 l diesel engines

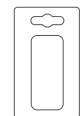

Ref.	⊠	EAN
11-383	20/100	5907558452266

## Klucze do spustu oleju

Oil drainer set / Ölablassschlüssel / Ключи для слива масла / Ключи для зливання оливи / Olajleeresztő kulcs készlet / Chei pentru dop de scurgerea uleiului / Klíče na vypuštění oleje / Sada klíčov na vypúšťanie oleja / Vijaki za spuščanje olja / Raktai alyvos išleidimui / Eļļas nolaišanas atslēgas / Õlikorgi võtmed / Ключове за източване на масло / Ключеви за испуштање уља / Ключеви за испуштање уља / Σετ αποστράγγισης λαδιού / Llaves para evacuación de aceite / Inserti per tappo olio / Chaves para evacuação de óleo / Clés pour la vidange d'huile / Sleutels voor oliedreinage

NEO  
TOOLS

CrV  
steel

3/8"

x18



Zastosowanie / Application / Применение:

Hex 8 mm: BMW, Ford, GM  
Hex 9 mm: Ford  
Hex 10 mm: Ford  
Hex 12 mm: Fiat, Lancia, Peugeot  
Hex 14 mm: Lancia, Mercedes  
Hex 17 mm: Audi, VW, BMW, Austin  
Square 7, 8 mm Citroen, Peugeot, Renault, Talbot, Volvo  
Square 11 mm: Ford  
Square 13.1 mm: Nissan, Subaru  
Square 3/8": Honda, Mazda, Renault, Saab, Volvo  
Square (5/16"), 10 mm Female, Square: 10 mm: do skrzyżni biegów i mechanizmów dyferencyjnych różnych marek aut np. / for gearboxes and differential mechanisms of various makes / для коробок передач и дифференциала автомобилей разных марок: BMW, Ford, Renault, Toyota  
Triangular: 10 mm Renault  
M16 Spline (Tampereproof): Audi A4 i A6

Ref.	⊠	EAN
11-235	0/10	5907558417098



## Klucz do filtra oleju

Oil filter wrench / Schlüssel für Ölfilter / Съёмник масляных фильтров / Ключ для масляных фильтров / Olajszűrő leszedő / Cheie pentru filtre de ulei / Ključ na olejovj filter / Ključ na olejovj filter / Ključ za oljni filter / Raktas tepalo filtrui / Eljas filtrui atslega / Ölfiltrivöti / Ключ за маслен филтър / Ključ za filtre za ulje / Ključ za filter za ulje / Κλειδί αφαίρεσης φίλτρου λαδιού / Llave para filtros de aceite / Chiave per filtro olio / Chave para filtros de óleo / Cle filtre a huile / Filtersteutel

NEO  
TOOLS

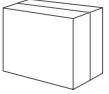

Ref.	Ra[mm]	📦	EAN
11-237	43-102	1/40	5907558437355

NEO  
TOOLS

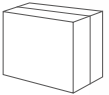

Ref.	Ra[mm]	📦	EAN
11-239	64-100	1/40	5907558435924

NEO  
TOOLS

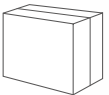

Ref.	Ra[mm]	📦	EAN
11-238	64-120	1/40	5907558437362

NEO  
TOOLS



60-115  
mm



1/2"

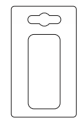

Ref.	Ra[mm]	📦	EAN
11-381	60 - 115	5/20	5907558445459

NEO  
TOOLS



60-160  
mm

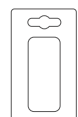

Ref.	Ra[mm]	📦	EAN
11-382	60 - 160	6/24	5907558445466

NEO  
TOOLS



20°

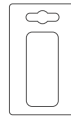

Ref.	Ra[mm]	📦	EAN
11-240	63.5 - 116	6/36	5907558435931

NEO  
TOOLS



30°  
60°  
90°

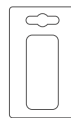

Ref.	Ra[mm]	📦	EAN
11-241	63.5 - 116	5/30	5907558435931

NEO  
TOOLS



Ref.	Ra[mm]	📦	EAN
11-231	73 - 85	6/36	5907558416657

NEO  
TOOLS



80-115  
mm

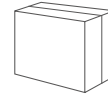

Ref.	Ra[mm]	📦	EAN
11-380	80 - 115	1/20	5907558445442

TOPEX

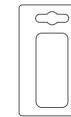

Ref.	Ø max [mm]	📦	EAN
37D207	120	12/120	5902062230386

TOP TOOLS

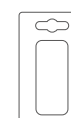

Ref.	📦	EAN
37D205	12/36	5902062040596



## Odciągarka do oleju

Oil suction gun / Ölabszieher / Отсосное устройство для масла / Оливодсмоктувач / Olajleszívó / Trägator de ulei / Odsávačka oleje (ručni) / Odsávačka na olej / Črpalka za olje / Alyvos siurblys / Eļļas atvilcējs / Ölisüstal / Засмывающая масляная помпа / Sisaljka za ulje / Putra za ispuhavanje ulja / Αναρροφητήρας λαδιού / Dispositivo de extracción de aceite / Pistola di aspirazione olio / Máquina de remover óleo / Vidangeur d'huile / Olieafzuiger

**NEO**  
TOOLS



METAL

280  
mm

PRESSOL

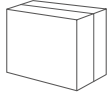

Ref.	[ml]	Ø [mm]	L [mm]	☒	EAN
11-510	500	56,4	280	0/20	5907558415346
11-511	1000	62,5	400	0/10	5907558415353

Ref.	[ml]	☒	EAN
12 902	500	1/0	4103810129025
12 908	1000	1/0	4103810129087

## Wanna do oleju

Oil drain bucket / Ölwanne / Ванночка для масла / Ванна оливова / Olajkád / Baie de ulei / Vana na olej / Vaňa na olej / Posoda za olje / Vonele tepalui / Vanniņa eļļai / Ölivann / Вана за масло / Posuda za ulje / Kada za ulje / Λεκάνη αποστράγγισης λαδιού / Bandeja para aceite / Contenitore olio / Bandeja para troca de óleo / Bac à huile

**NEO**  
TOOLS



7  
dm<sup>3</sup>

PLASTIC

PRESSOL



6  
dm<sup>3</sup>

PLASTIC

Ref.	☒	EAN
11-550	0/10	5907558415360

Ref.	☒	EAN
24 110	1/5	4103810241109

## Kanister na benzynę

Can for petrol / Benzinbehälter / Канистра для бензина / Канистра для бензину / Üzetanyagkanna, műanyag / Bidon de benzina / Kanistr na benzin / Kanistra na benzin / Kanister za benzin / Bakas benziniui / Benzina kanna / Bensiinkanister / Бидон за бензин / Kanister za benzin / Kanta za benzin / Κάνιστρο βενζίνης / Bidón para gasolina / Tanica per la benzina / Tanque para gasolina / Jerrycan à essence / Jerrycan voor benzien

**NEO**  
TOOLS



HDPE  
PP  
LDPE

Ref.	V [l]	☒	EAN
11-560	10	0/50	5907558436402
11-561	20	0/30	5907558436419

## Lejek

Funnel / Trichter / Воронка / Воронка / Tölcsér, flexibilis, szűrővel / Pálnie / Nálevka / Lievik / Lijak / Piltuvēlis / Piltuve / Lehter / Фуння / Lijevak / Levak / Хови / Embudo / Imbuto / Funil / Entonnoir / Trechter

**NEO**  
TOOLS



1,2 L  
HDPE  
LDPE

Ref.	Ø <sub>1</sub> [mm]	Ø <sub>2</sub> [mm]	☒	EAN
11-555	45	160	0/6	5907558436396

PRESSOL



02 562

02 372

02 366

Ref.	Info	☒	EAN
02 366	ø210 x 24,5 mm	1/6	4103810023668
02 372	ø160 x 21,5 mm	1/6	4103810023729
02 562	ø160 x 20,0 mm	1/6	4103810025624

PRESSOL



21 127



21 127-950

Ref.	V [l]	☒	EAN
21 127	20	1/0	4103810211270
21 127-950	20	1/0	4103810424571

**TOP TOOLS**



x4

Ref.	Ø [mm]	☒	EAN
77P530	50,75,95,115	0/72	5902062173188



## Smarownica dźwigniowa

Lever-operated grease gun / Schmierspritze mit Hebel / Шприц рычажно-плунжерный / Шприц важільно-плунжерный / Karos zsírzó / Gresor cu prghie / Páková maznice / Páková mazica / Ročna mazalka / Rankinis tepalo presas / Leļļotājs ar sviru / Kangiga määrimisseade / Ръчна масло̀нька / Mazalica ručna / Mazalica na rupu / Γρασαδὸρος με μοχλό / Engrasadora de palanca / Pistola per grasso / Pistola de lubrificação / Graisseur à levier

NEO  
TOOLS

400  
cm<sup>3</sup> 10000  
Psi 8x300  
mm



Ref. 11-500 Info. 0/10 EAN 5907558415278

PRESSOL



Ref. 12 632 Info. 500 cm<sup>3</sup> + 12 635 + 12 631 EAN 4103810126321

PRESSOL



Ref. 12 630 Info. 500 cm<sup>3</sup> + 12 656 + 12 631 EAN 4103810126307

## Wężyk do smarownic

Hose for grease gun / Schlauch für Schmiergeräte / Шланг смазочный / Шланг до дозаторів оливи / Zsírzó cső / Furtunpentru pistol de gresare/ungere / Hadička pro mazničky / Hadička do maznic / Cev za mazalnike / Žarnele tepalinems / Caurulite eļļas kanniņai / Ölprüstolivoolik / Маркуч за масло̀нька / Crjevo za mazalice / Crevo za podmazivanje / Εύκαμπτος σωλήνας λίπανσης / Mangueira para engrasadoras / Tubo in Nylon / Mangueira para lubrificadores / Flexible de graisseur / Slang voor smeerapparaten

NEO  
TOOLS



do smarownicy 11-500  
for 11-500 grease gun  
для нафтовинів 11-500

Ref. 11-532 Info. L [mm] 11x300 EAN 5907558415308

PRESSOL



Ref.	info	EAN
12 655-810	11 x 300 mm + 12 631	4103810420290
12 665-810	11 x 500 mm + 12 631	5902062000033
12 656-810	8 x 300 mm + 12 631	4103810426506
12 666-810	8 x 500 mm + 12 631	5902062153371

PRESSOL



Ref. 12 679 Info. 500 cm<sup>3</sup> + 12 655 + 12 643 EAN 4103810126796

PRESSOL



Ref. 12 636-101 Info. 500 cm<sup>3</sup> + 12 655 + 12 631 EAN 4103810129810

TOPEX

400  
cm<sup>3</sup> 8x300  
[mm]

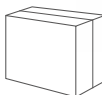

Ref. 97X300 Info. 0/10 EAN 5902062003591

## Końcówka smarownicza

Grease coupler / Schmiernippel / Насадка / Наконечник змащувальний / Zsírzófej, négyprófas / Piesa de ungere / Mazací koncovka / Mazací nástavec / Mazalni nastavek / Antgalis / Četřžoklu ieļļošana / Määrimisotsak / Четурчелюстен / Glava mazalice / Podmazna kupa / Тоок урсаодо̀ору / Punta de engrase / Terminale a 4 ganasce con attacco M10x1 / Ponta de lubrificação / Embout de graissage

PRESSOL



Ref.	info	EAN
12 643	M10x1	4103810126437
12 631	M10x1	4103810126314

## Smarowniczka

Grease nipple / Öl / Масло̀нька / Оливница / Zsírzószem / Cană de ungere / Maznička / Maznička / Mazalica / Tepalo - dozatorius / Eļļa kanniņa / Väike määrdrupp / Ръчна масло̀нька / Dozer za mazivo / Mala mazalica / Ελαιοβεξαμενή / Engrasadora / Punto de ingrassaggio / Lubrificador / Raccord de graissage / Smeernippel

PRESSOL



Ref.	info	EAN
15 007	H1, M6 x 1	5902062011756
15 009	H1, M8 x 1	5902062011749
15 013	H1, M10 x 1	4103810440144
15 113-140	H2, M10 x 1	5902062153975



## Separator

Spreader / Abscheider / Съемник / Сепаратор / Fékmunkahenger visszanyomó tárcsafékhézh / Separator / Separátor / Separátor / Separator / Separatori / Separators / Separador / Сепаратор / Separator / Separator / Διαχωριστήρας / Separador / Separatore / Separator / Séparateur / Separator

**NEO**  
TOOLS

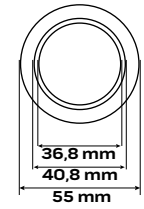
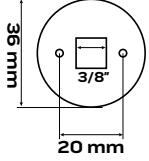
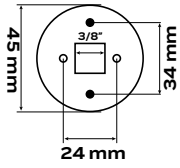

Ref.	Ra[mm]	☒	EAN
11-125	35-90	5/20	5907558437218

**NEO**  
TOOLS

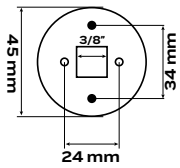

Ref.	Ra[mm]	☒	EAN
11-126	25-60	5/20	5907558437232

**NEO**  
TOOLS

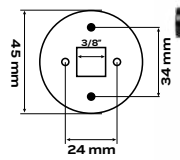

Ref.	Ra[mm]	☒	EAN
11-127	25-60	5/20	5907558437232

**NEO**  
TOOLS



Ref.	Ra[mm]	☒	EAN
11-128	40-70	1/20	5907558437249

## Zestaw ręcznych separatorów do zacisków hamulcowych

Set of hand separators for brake calipers / Bremskolbenrückstellersatz / Комплект приспособлений для обслуживания тормозных цилиндров / Набор ручних сепараторів для гальмівних колодок / Tárcsafék szerelő és visszanyomó készlet / Set manual de separatori la cleme de frană / Sada na montáž kotoučových brzd / Súprava na montáž kotúčových brzd / Set ročních ločevalnikov zavornih batov / Stabdžiu cilindru suspaudimo komplektas / Bremžu cilindru manuālo separatoru komplekts / Piduriklotside sepaaratorite komplekt / Комплект рьчни сепаратори за спирачните клеми / Set ručnih odvajaja za kočione stezaljke / Pribor ručnih separatora za kočione stezače / Set συντήρησης κυλίνδρων πέδησης / Juego de separadores manuales para las pinzas de freno / Utensili per il riposizionamento dei pistoncini dei freni / Jogo de separadores manuais para maxilas de travão / Jeu de séparateurs manuels pour étriers de freins / Set voor handmatige afstanders voor remklemmen

**NEO**  
TOOLS



Ref.	☒	EAN
11-123	0/10	5907558419993

**NEO**  
TOOLS



Ref.	☒	EAN
11-122	0/5	5907558419986

**NEO**  
TOOLS



Ref.	☒	EAN
11-129	1/5	5907558437256



## Separator pneumatyczny z końcówkami

Air brake caliper wing tool / Einstellwerkzeug für pneumatische Bremszylinder / Инструмент регулировки пневматического тормозного цилиндра / Инструмент регулирования пневматического гальмיוного цилиндра / Pneumatikus fékhenger beállító eszköz / Instrument de reglare a cilindrului de frână pneumatic / Nástroj pro seřízení pneumatického brzdového válce / Nástroj na nastavenie pneumatického brzdového valca / Orodje za nastavitve pnevmatičnega zavornega valja / Pneumatinis stabdžių cilindro reguliavimo įrankis / Pnevmatisks bremžu cilindra regulēšanas rīks / Pneumatiline pidurisilindri reguleerimise tööriist / Пневматичен инструмент за регулиране на спирачния цилиндър / Alat za podešavanje pnevmatskog kočnog cilindra / Алат за podešavanje pnevmatskog kočnog cilindra / Εργαλείο ρύθμισης κυλίνδρου πεπιεσμένου αέρα / Herramienta de ajuste del cilindro de freno neumático / Strumento di regolazione del cilindro del freno pneumatico / Ferramenta de ajuste de cilindro de freio pneumático / Outil de réglage du cylindre de frein pneumatique / Luchtremklauw vleugel gereedschap

NEO  
TOOLS



16  
ELEMENTS

L/R

1/4"

Ref.	📦	EAN
11-132	0/5	5907558445435

## Ściernice do czyszczenia piast

Wheel hub grinder Schleifmittel zur Reinigung von Naben / Шлифовальные круги для очистки ступицы / Шліфувальні круги для очищення маточин / Kerékagy tisztító dörzstárcsa / Discuri pentru curățarea butucilor / Brusné kotouče pro čistění nábojů / Brusné kotúče na čistenie nábojov / Brusi za čiščenje pest / Įrankiai ratų stebulių valymui / Ritepa rumbas tūrišanas slīpdiski / Rataste puhastamise lihvketad / Почистовачи четки за главци / Diskovi za čiščenje glavčine / Brusione ploče za čiščenje čvorišta / Τροχοί λείανσης για καθαρισμό πλῆμνης τροχού / Amoladora para limpiar cubos de ruedas / Dischi abrasivi per la pulizia di mozzi / Escovas circulares para limpeza de cubos de rodas / Meules pour nettoyage des moyeux / Wielnaaf grinder voor reiniging

NEO  
TOOLS

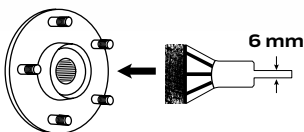

Ref.	📦	EAN
11-135	25/50	5907558437287

## Zestaw do sprawdzania bicia tarcz hamulcowych

Brake disc run out kit / Prüfsatz für Unrundlauf von Brems Scheiben / Набор для проверки тормозных дисков / Набор для перевірки гальмівних дисків / Tárcsafék ütésmerő készlet / Trusă pentru verificarea bătăii discurilor de frână / Sada pro kontrolu brzdových kotoučů / Súprava na kontrolu brzdových kotúčov / Komplet za preverjanje zavornih diskov / Rinkiny stabdžių diskų patikrinimui / Bremžu disku pārbaudes instrumentu komplekts / Piduriketaste kontrollimise komplekt / Комплект за проверка на биемето на спирачните дискове / Set za proveru kočionih pločica / Pribor za proveru kočionih diskova / Σε ελέγχου διακοφρένων / Kit para la comprobación de los discos de freno / Kit per il controllo dell'oscillazione assiale dei dischi freno / Kit de verificação de batimento dos discos de travão / Kit de mesure pour disques de freins / Remschijf opraken kit

NEO  
TOOLS



Ref.	📦	EAN
11-130	1/10	5907558437263

## Zestaw do montażu szczęk hamulcowych

Tool kit for brake shoe fitting / Bremsbacken-Montagewerkzeugsatz / Инструмент для обслуживания тормозной системы / Набор для монтажу гальмівних колодок / Fékprofaszereelő készlet / Set pentru montarea sabotilor de frana / Sada na montáž brzdových čelistí / Súprava na montáž brzdových čelistí / Set za montažo zavornih čeljusti / Stabdžių trinkelų montavimo rinkinys / Bremžu uzliku turētāju montāžas komplekts / Piduriketaste paigaldamise komplekt / Комплект за монтиране на спирачните челюсти / Set za montažu kočionih čeljusti / Pribor za montažu kočionih čeljusti / Εργαλεία συντήρησης ουστημάτων πέδησης / Kit de montage de mordazas de frenos / Kit per montaggio pinze del freno / Jogo de ferramentas para montagem de maxilas de travão / Jeu d'outils de montage de mâchoire de frein / Set voor montage van remkaken

NEO  
TOOLS



Ref.	📦	EAN
11-131	1/5	5907558437270



## Klucz do kół

Wheel wrench / Radschlüssel / Ключ для колес / Ключ для монтажу кол автомобильных / Kereszt kerékkulcs / Cheie piuliță p/u demontarea și montarea roților / Ključ na kola / Ključ na kolesá teleskopický / Ključ za avtomobiliska kolesa / Raktas ratams / Ritepu atslēga / Rattavöti / Ключ за гуми / Ključ za kotač / Ključ za točak / Κλειδί για τροχούς / Llave extensible para ruedas / Chiave a croce / Chave para filtro / Clef pour filtre / Wielsleutel

NEO  
TOOLS

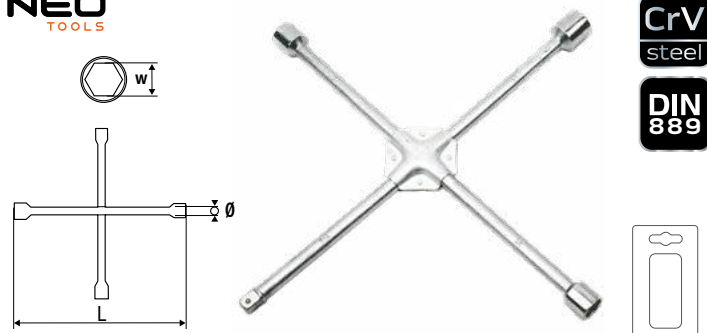

Ref.	W	ø[mm]	L[mm]	⊠	EAN
11-100	17x19x22x1/2"	16	355	0/16	5907558412864

NEO  
TOOLS

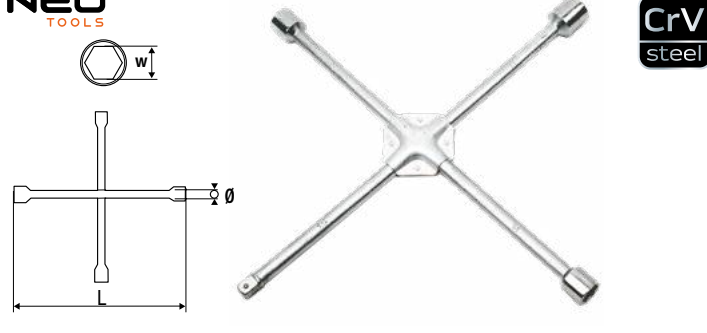

Ref.	W	ø [mm]	L [mm]	⊠	EAN
11-102	24 x 27 x 32 mm, 3/4"	22	700	0/4	5907558418309

NEO  
TOOLS



Ref.	W	⊠	EAN
11-101	17x19x1/2"	6/12	5907558417135

TOPEX



Ref.	W [mm]	L [mm]	⊠	EAN
37D305	17/19	340/520	0/24	5902062040671

TOPEX

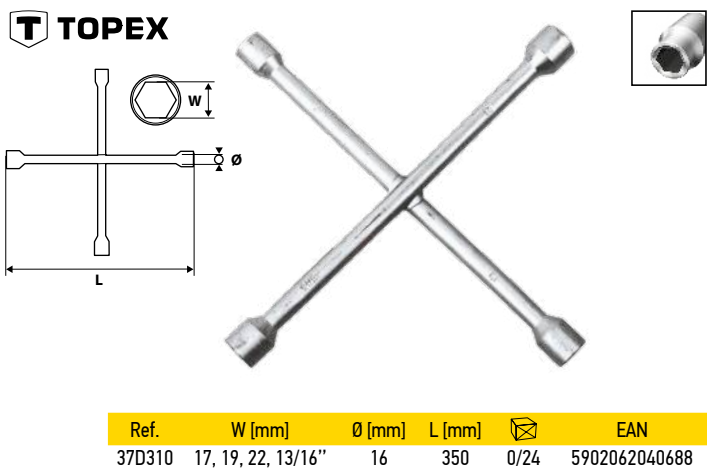

Ref.	W [mm]	Ø [mm]	L [mm]	⊠	EAN
37D310	17, 19, 22, 13/16"	16	350	0/24	5902062040688

TOPEX

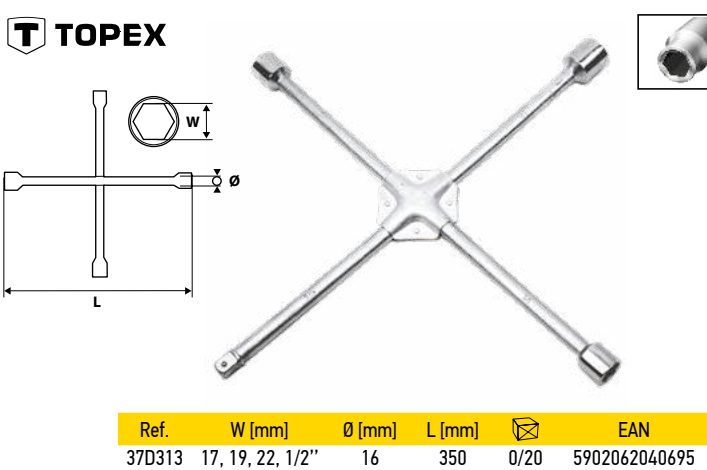

Ref.	W [mm]	Ø [mm]	L [mm]	⊠	EAN
37D313	17, 19, 22, 1/2"	16	350	0/20	5902062040695

## Zestaw łomów

Go-through pry bar set / Brechstangen-set / Набор монтажек / Набор ломов / Feszítővas készlet / Set de răngi de oțel / Sada pačidel / Súprava pačidel / Komplet lomik / Laužtuvų rinkinys / Laužtuvų komplekts / Kangide komplekt / Комплект щангу / Set poluga / Garnitura poluga / Σετ κουτάλες / Juego de palancas / Set di leve da sforzo / Kit de pés-de-cabra / Jeu de pieds-de-biche / Set van breekijzers

NEO  
TOOLS

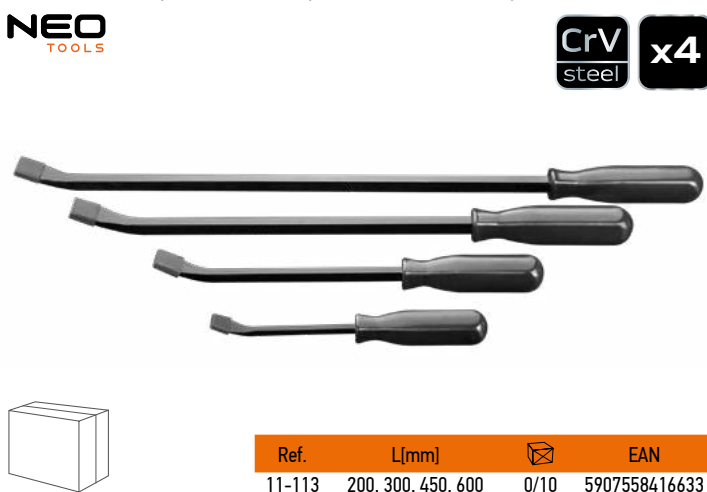

Ref.	L[mm]	⊠	EAN
11-113	200, 300, 450, 600	0/10	5907558416633

## Łyżka do opon

Wrecking bar / Reifenlöffel / Монтажна автомобильная / Монтувалка / Gumibroncs szerelővas / Levier pentru pneu / Montážní páka na pneumatiky / Páka na pneumatiky / Žlička za pneumatike / Svirts padangų montavimui / Lápstipa riepu montāžai / Rehvilusikas / Щанга за демонтаж на гуми / Podizač za montiranje guma / Kašika za gumu / Κουτάλα φανοποιίας / Llave cuchara para extraer ruedas / Leve per pneumatici / Ferramenta para rodas / Demonte-pneus / Breekijzer

NEO  
TOOLS

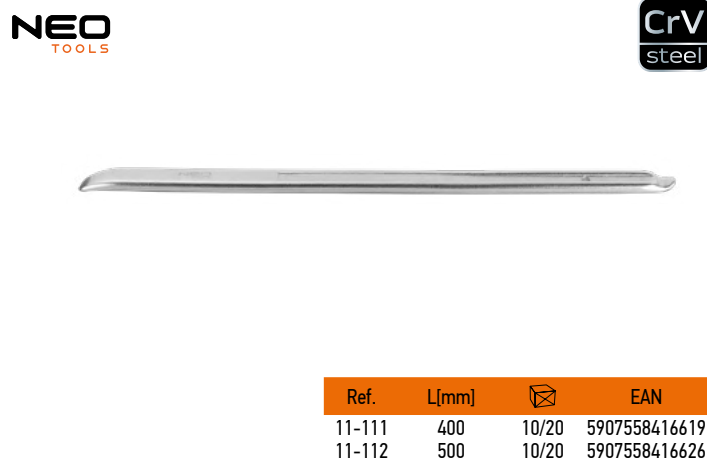

Ref.	L[mm]	⊠	EAN
11-111	400	10/20	5907558416619
11-112	500	10/20	5907558416626



## Nasadka do świec

Spark plug socket / Aufsatz für Zündkerzen / Головка сменная свечная / Ключ свечной / Gyertyakulcs / Cheie tubulara pentru bujii / Nástavec na svičky / Nástavec na svečice / Nasadni ključ za svečke / Galvutė žvakėms / Sveču atslēga / Künnlapadrun / Наставка за свеци / Карка за свјеџице / Nasadka za svećice / Καρδιάκι για μπουζί / Vaso para bujía / Chiave per candele / Bocal p. velas / Douille à bougie / Kaarsendop

**NEO**  
TOOLS

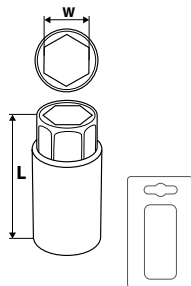

CrV  
steel

1/2"

Ref.	W [mm]	L [mm]	☒	EAN
08-090	16	65	24/144	5907558406092
08-091	21	68	24/96	5907558406252

**T TOPEX**

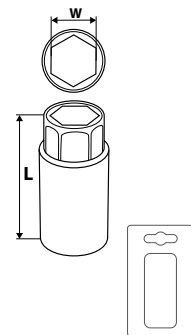

CrV 1/2"

Ref.	W [mm]	L [mm]	☒	EAN
38D764	16	65	20/160	5902062387646
38D765	21	65	12/96	5902062387653

## Klucz do świec

Spark plug wrench / Zündkerzenschlüssel / Ключ свечной / Ключ для свечок / Gyújtógyertyakulcs / Cheie luminare / Klič na svičky / Klič sviečkový / Ključ za vžigalno svečko / Raktas degimo žvakėms / Svečatslēga / Süütekiünla võti / Ключ / Ключ / Κλειδί για μπουζί / Llave para bujía / Busssole poligonali / Chave p. velas / Clef à bougie / Kaarsleutel

**NEO**  
TOOLS



3/8"

Ref.	W [mm]	L [mm]	☒	EAN
11-152	14	90	50/100	5907558417166
11-153	16	90	50/100	5907558417173

**T TOPEX**



CrV

Ref.	W [mm]	☒	EAN
37D051	21	1/70	5902062370518
37D052	16	1/70	5902062370525

**TOP TOOLS**



Ref.	W [mm]	☒	EAN
37D221	21	6/60	5902062040657
37D222	16	0/60	5902062040664

## Szczypce do ściągania przewodów zapłonowych

Spark plug wire boot pliers / Zange zum Abziehen von Zündkabeln / Плоскогубцы для снятия проводов зажигания / Плоскогубци для знімання дротів запалювання / Gyújtókábel lehúzó fogó / Clește pentru scoaterea cablurilor de aprindere / Kleště na kabely zapalovacích svíček / Kliešte na demontáž zapalovacích vodičov / Klešče za vtiče vžigalnih svečk / Replij rinkiny, užvedimo laidų nužievimui / Platknabiles aizdedzes vadu noņemšanai / Süütejuhtmete näpitsad / Клеци за кабели на свециме / Kliešta za skidanje žica za paljenja / Kliešta za skidanje kablova svećica / Πένα εξαγωγής μπουζοκαλωδίων / Alicates para quitar los cables de arranque / Pinze per lo scollamento dei cavi d'accensione / Alicates para extração de cabos de ignição / Pince pour enlever les câbles batterie / Tangen voor bougie leidingen

**NEO**  
TOOLS

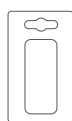
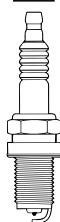

Ref.	☒	EAN
11-165	5/20	5907558437294

## Szczelinomierz

Feeler gauge / Schiebelehre / Щуп / Щуп / Hézagmérő készlet / Calibru măsurare grosime / Spároměr / Listkové miery / Kontrolni lističi / Ertmių matavimo prietaisai / Spraugmērs / Mõõtesond / Луптомер / Kontrolni lističi / Kontrolni lističi / Διακενόμετρο / Calibre de espesores / Calibro a spessore / Medidor de folgas / Jauge d'épaisseur / Voelmaat

**NEO**  
TOOLS

STAINLESS  
steel 65  
Mn



11-192

Ref.	Ra [mm]	N	☒	EAN
11-190	0.04 - 0.63	26	20/120	5907558452433
11-191	0.05 - 1.0	20	20/120	5907558452440
11-192	0.127 - 0.508	16	20/120	5907558452457





## Ściągacze do sprężyn

Spring pullers / Abzieher für Feder / Съёмные приспособления для пружин / Знімачі пружин / Rugóösszehúzó kézi / Ancore de arcuri / Stahovák pružin / Stahovák pružin / Izvlekači za vzmeti / Spyruoklių spaustai / Atsperu noņemama ierīce / Vedrutõmmitsad / Скобы за пружину / Skidači za opruge / Stega za oprugu / Εξωλέκας ελατηρίων / Extractor de muelles / Pressori per molle / Ponta de aperto para molas / Extracteurs de ressorts / Trekkers voor veren

NEO  
TOOLS



Ref.	Ra[mm]	☒	EAN
11-796	23-280	1/5	5907558436747

NEO  
TOOLS



125/212 mm, 8/160 mm, 65/125 mm.

BMW: E31 - E67, MINI R50/R52/R53, Fiat, Alfa Romeo, Chrysler, Lancia, Ford, Mazda, Honda, Hyundai, Jaguar, Jeep, Kia, Mercedes C/E, Citroen, Peugeot, Opel, Vauxhall, Saab, Renault, Nissan, Infiniti, Dacia, Mitsubishi, Rover, Subaru, Toyota, Audi, Porsche, Skoda, VW, Volvo

Ref.	☒	EAN
11-797	1/1	5907558436754

## Ściągacz do koła kierownicy

Steering wheel puller / Abzieher für Lenkradsrad / Съёмное устройство рулевого колеса / Знімач керма / Kormánykerék leszedő készlet / Ancoră de volan / Stahovák volantu / Stahovák volantu / Izvlekač za volan / Vairo traukės nuėmiklis / Stūres rata noņemama ierīce / Juhtratta tõmmits / Скоба за колелото на волана / Skidač kotača volana / Stega za upravljač / Εξωλέκας τιμονιού / Extractor de volante / Estrattore di volante / Ponta de aperto para volante / Extracteur de volant / Trekker voor stuurwiel

NEO  
TOOLS



Ref.	☒	EAN
11-816	5/20	5907558419696

NEO  
TOOLS



70/130 mm, 90/150 mm  
Mercedes

W123, W124, W126, W140, W202, W210

W107, W114, W115, W116, W123, W124, W126, W129, W140, W201, W202, W203

Opel / Vauxhall / Hyundai / Lada / Rover / Saab / Fiat / Ford / Mazda / Toyota / Nissan / Mitsubishi / Peugeot / Volo / VW

Ref.	Ra[mm]	☒	EAN
11-798	70-130; 90-150	1/2	5907558436761

NEO  
TOOLS

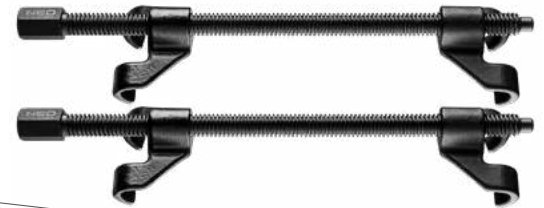
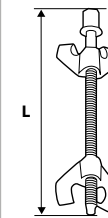

Ref.	L[mm]	☒	EAN
11-807	300	0/10	5907558418453

NEO  
TOOLS

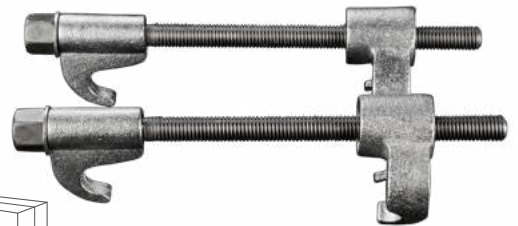
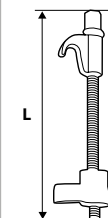

Ref.	L[mm]	☒	EAN
11-808	300	0/10	5907558418460

## Dźwignia do przegubów

Lever for articulated joints / Hebel für Gelenke / Рычаг для шарниров / Важіль до шарнирів / Gömbfejserelő villa / Levier de articulation / Podpěra kloubů / Páka k čarom / Vítice za zglobne / Vyrji svirtis / Šarniru svira / Klambrikang / Лост за шарнири / Poluga za zglobove / Poluga za zglobove / Μοχλός μεντεσέδων / Palanca para rótulas / Leva per giunti articolati / Alavanca p. Articulações / Levier pour articulations / Hefboom voor spilverbindingen

NEO  
TOOLS

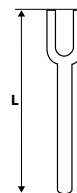

Ref.	L [mm]	☒	EAN
11-805	300	0/12	5907558418590
11-806	400	0/12	5907558418606



## Ściągacz do przegubów

Ball joint puller / Gelenkabziehvorrichtung / Съёмник шарниров / Пристрій для зняття шарнірів / Gömbcsukló kinyomó / Extractor articulații sferice / Stahovák kloubů / Stahovák na gulavé čapy / Snemalec / Nuémiklis sarnyrams / Novilcējs / Kuulivedstõmmitis / Скоба за болтове / Izvlakač / Radarciger / Кρικοπάλαυκα για καστανίς / Extractor de juntas de rótula / Estrattore di giunti a sfera / Ponta de aperto de articulações / Arrache-articulations / Trekker voor spilverbindingen

NEO  
TOOLS

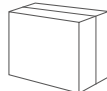
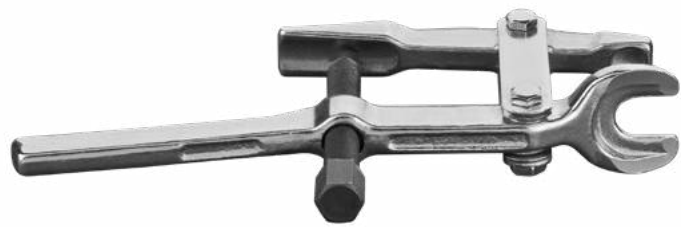

Ref.	ø [mm]	☒	EAN
11-801	20	0/20	5907558416527

NEO  
TOOLS

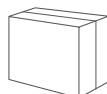
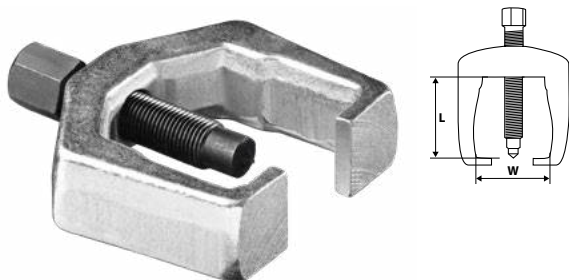

Ref.	L [mm]	W [mm]	☒	EAN
11-803	45	27	0/20	5907558418439
11-804	65	32	0/20	5907558418446

## Zestaw ściągaczy do drążków kierowniczych

Steering rods puler set / Abziehvorrichtungssatz für Spurstangen / Набор съёмников шаровых опор и рулевых наконечников / Набор знімачів до кермових тяг / Kormányösszekató-gömbfejkinymó készlet / Set trágätoare bare de comandă / Sada stahováků táhel řízení / Sada stahovákov tiahiel riadenia / Set izvlekačev za krmilne drogove / Guolinių atramų ir vairo traukių nuėmimo rinkinys / Stūres uzgaļu un sfērisko balstu novilcēju komplekts / Roolivarda tõmmitisate komplekt / Комплект скобы за изваждане на нормилни щанги / Set skidača za upravljačke šipke / Pribor alatki za skidanje upravljačkog stalka / Set εξωλέκων σφαιρικών αρθρώσεων και κατευθυντήριων ραβδών / Juego de extractores de barras de dirección / Kit di estrattori per tiranti dello sterzo / Kit de extractores de barras de direção / Kit d'extracteurs de biellette de direction / Trekkers voor stuurstangen

NEO  
TOOLS



Ref.	☒	EAN
11-799	1/2	5907558436778

NEO  
TOOLS

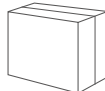
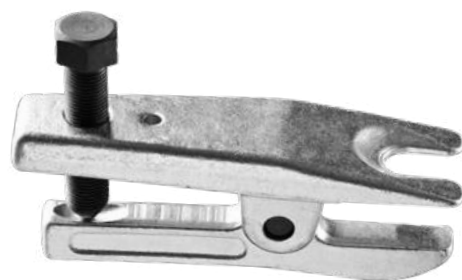

Ref.	ø [mm]	☒	EAN
11-802	19	0/20	5907558418422

TOPEX

CrV

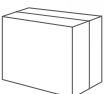
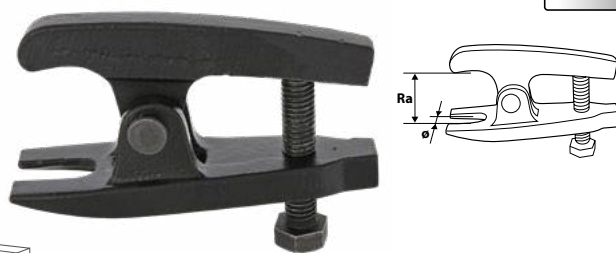

Ref.	Ra [mm]	ø [mm]	☒	EAN
37D410	45	15	5/20	5902062374103

## Ściągacz z siłownikiem

Hydraulic puler / Abzieher mit Servoantrieb / Съёмник с гидроприводом / Знімач із гідроприводом / Lehúzó hidraulikus rásegítéssel / Extractor cu dispozitiv de acționare / Hydraulický stahovák / Stahovák so servomotorom / Hidravlični izvlekač / Hidraulinis nutraukiklis / Novilcējs ar hidropiedziņu / Servomotoriga tõmmitis / Инструмент за демонтаж с цилиндър / Skidač sa cilindrom / Alatka za skidanje sa hidraulikom / Υδραυλικός εξωλέκας / Extractor con accionador / Estrattore con cilindro / Extrator com acionador / Extracteur avec vérin / Hydraulische trekker

NEO  
TOOLS

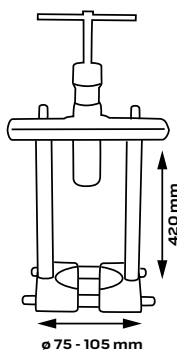

Ref.	☒	EAN
11-847	1/2	5907558436853



## Ściągacz trójramienny

Three-arm puller / 3-Arm Abzieher / Съёмник с тремя захватами / Знімач тріплечевої / Csapágylehúzó, háromkormány / Extractor cu trei brațe / Трёхручійний стahовák / Trojramenný stahovač / Trokraki snemalec / Trižiaunis nutraukiklis / Trīsplecu novilcējs / Kolmeharuline tõmmits / Трёхручійна скоба / Trokraki izvlakač / Trokraki alat za skidanje / Εξολκέας με τρεις σιαγόνες / Extractor de tres brazos / Estrattore a tre griffe / Extrator de três braços / Arrache à trois branches / Driearmige trekker

NEO  
TOOLS

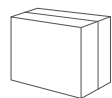
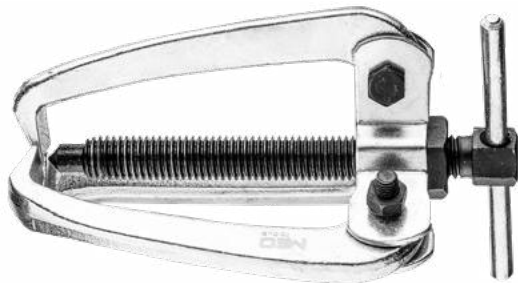

Ref.	L[mm]	☒	EAN
11-868	25	0/50	5907558420128
11-869	50	0/50	5907558420135
11-870	75	0/50	5907558420142

NEO  
TOOLS

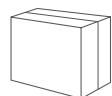

Ref.	L[mm]	☒	EAN
11-857	150	0/16	5907558416862
11-858	200	0/6	5907558416879
11-859	300	0/2	5907558416886

NEO  
TOOLS

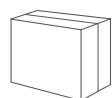

Ref.	L[mm]	☒	EAN
11-861	100	0/20	5907558416794
11-862	150	0/10	5907558416800

TOPEX

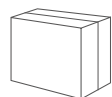

Ref.	Ø [mm]	L [mm]	☒	EAN
37D405	75	50	0/30	5902062040770
37D406	100	55	0/20	5902062040787

## Ściągacz dwuramienny

2 jaws puller / Abzieher mit zwei schenkeln / Съёмник подшипников 2-х лапчатый / Знімач двоплечевої / Csapágylehúzó, kétkormány / Extractor cu două brațe / Stahovák dvouramenný / Dvojrarmenný stahovák / Dvokraki snemalec / Nuēmējas, divšakis / Divplecu novilcējs / Kaheharuline tõmmits / Двуручійна скоба / Dvostruki odvažac / Dvokraka stega / Εξολκέας έναρριων τριβέων με 2 σιαγόνες / Extractor de dos brazos / Estrattore a due griffe / Sacador de 2 garras / Extracteur a 2 bras / Tweearmig trekker

NEO  
TOOLS

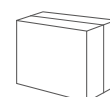

Ref.	L[mm]	☒	EAN
11-871	25	25/100	5907558420159
11-872	50	25/100	5907558420166
11-873	75	25/50	5907558420173

NEO  
TOOLS

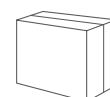

Ref.	L[mm]	☒	EAN
11-850	75	0/50	5907558416817
11-851	100	0/50	5907558416824
11-852	150	0/50	5907558416831

NEO  
TOOLS

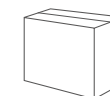
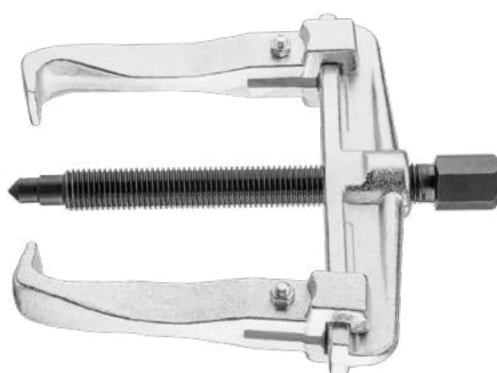

Ref.	L[mm]	☒	EAN
11-865	100	0/16	5907558418514
11-866	110	0/12	5907558418521
11-867	140	0/12	5907558418538

## Ściągacz do ramion wycieraczek

Wiper arm puller / Abzieher für Scheibenwischer / Съёмник рычагов стеклоочистителя / Знімач важелів склоочисників / Ablaktöröl kar lehúzó / Dispozitiv de scos de brate de stergător de parbriz / Stahovák na ramínka stieračů / Stáhovač na demontáž ramienok stieračov / Snemalec za brisalce / Valuytuv koty nuemiklis / Stikla tīrītāju plecu novilcējs / Kojamehe hoobade tõmmits / Скоба за рамо на чистачката / Alat za skidanje brizgaljki / Alat za skidanje ramena brisača / Εξολκέας μοχλών υαλοκαθαριστήρα / Extractor de brazos de limpiaparabrisas / estrattore per braccio del tergicristallo / Extrator de limpa para-brisas / Extracteur de bras d'essuie-glaces / Trekker voor ruitenwisserarmen

NEO  
TOOLS



Ref.	☒	EAN
11-827	0/120	5907558420067



## Ściągacz dwuramienny i separator

Gear puller set / Abzieher mit zwei schenkeln und ausscheider / Съёмник универсальный с сепаратором / Знімач двооплечевий і сепаратор / Csapágylehúzó készlet / Extractor universal cu două brațe și separator / Sada dvouramenný stahovák a oddělovač / Súprava dvojamenný stahovák a separátor / Komplet dvokrakega snemalca in ločilnika / Dvišakių nuėmėjų rinkinys su separatorium / Diplecu novilceja un separatora kompleks / Kaheharuline tõmmits ja sepaator / Комплект двураменна стяга със сепаратор / Set dvokraki skidač i separator / Garnitura dvokraka stega i separator / Εξολκείας γενικής χρήσης με διαχωριστή / Juego de extractores de dos brazos y separador / Set separatore per cambio / Kit sacador de 2 garras e separador / Jeu d'extracteurs a 2 bras et separateur / Tweearmig trekker en separator

NEO  
TOOLS



Ref.	📦	EAN
11-810	0/4	5907558416572

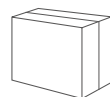

## Ściągacz do piast

Wheel hub puller / Abzieher für Radnaben / Съёмное приспособление для ступицы / Знімач маточин / Kerékagy lehúzó készlet / Ancoră de butuc / Stahovák hlavy kola / Stahovák náboja / Izvlekač za pesta / Stebulių spaustai / Rumbu noņemama ierīce / Rattarummu tõmmits / Скоба за втулку / Skidač za glavčine / Stega za glavčino / Εξολκείας πλήμνης / Extractor de cubos de ruedas / Estrattore a bilanciere / Ponta de aperto / Extracteur de moyeux / Trekker voor naaf

NEO  
TOOLS



Ref.	📦	EAN
11-811	5/20	5907558418484

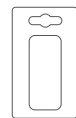

## Zestaw do demontażu poduszek powietrznych

Airbag removal tool set / Abbausatz für Luftkissen / Набор для замены подушки безопасности / Набор для заміни подушок безпеки / Légzsák kiszerező készlet / Set pentru scoaterea airbag-urilor / Sada na demontáž airbagů / Súprava na demontáž airbagov / Set za odstranitev zračnih blazin / Oro paagalvių išmontavimo rinkinys / Drošības spilvena noņemšanas instrumentu komplekts / ðhkratiyade eemaldamise komplekt / Комплект за демонтаж на въздушни възглавници / Set za skidanje zračnih jastuka / Pribor za demontiranje vazdušnih jastuka / Σετ αντικατάστασης αερόσακου / Kit de desmontaje de airbags / Kit per lo smontaggio di airbag / Kit de ferramentas de desmontagem de airbags / Kit de démontage des airbags / Set voor demontage van airbags

NEO  
TOOLS



Ref.	📦	EAN
11-817	1/10	5907558436785

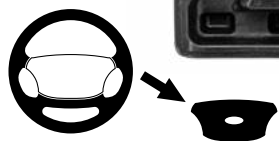

## Ściągacz do łożysk

Gear puller / Lagerabziehvorrichtung / Съёмник подшипников / Пристрій для зняття підшипників / Csapágylehúzó / Extractor elicoidal / Stahovák ložísek / Stahovák dvojamenný / Snemalec / Guolių nuėmiklis / Novilcejs gultņiem / Hammassratta tõmmits / Скоба за лезеру / Izvlekač / Radarciger / Κρικοπάλαγο για άξονες τριβής / Extractor de cojinetes / Estrattore rapporti / Ponta de aperto para rolamentos / Arrache-roulements / Lageronderbank

NEO  
TOOLS

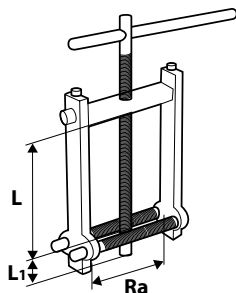

Ref.	L [mm]	L <sub>1</sub> [mm]	Ra [mm]	📦	EAN
11-813	100	20	24 - 55	0/30	5907558418507

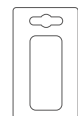

NEO  
TOOLS



Ref.	Ra [mm]	📦	EAN
11-848	35-130	1/2	5907558436860

NEO  
TOOLS

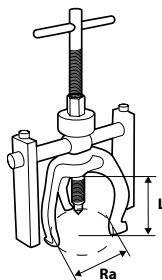

Ref.	L [mm]	Ra [mm]	📦	EAN
11-812	70	18 - 43	0/20	5907558418491

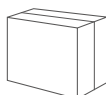

## Zestaw do ściągania i instalowania łożysk

Bearing removal and fitting kit / Radlager-Werkzeug-Satz / Набор для снятия/установки подшипников / Хабір для знімання та встановлення вальниць / Csapágszerező szerszámkészlet / Set de dispozitive de scos si de instalat lagare / Sada pro výměnu a montáž ložisek / Súprava na demontáž a inštaláciu ložísk / Set za snemanje in montažo ležajev / Guolių montavimo komplektas / Gultņu novilkšanas un instalēšanas komplekts / Laagrite eemaldamise ja paigaldamise komplekt / Комплект за стягане и инсталлиране на лагеру / Set za skidanje i instaliranje ležaja / Pribor za skidanje i instaliranje ležišta / Σετ αποβίβασης/αφαίρεσης τριβέων / Juego para extraer e instalar rodamientos / Kit estrazione e montaggio cuscinetti / Jogo de ferramentas para remover e instalar rolamentos / Jeu d'arrache-roulement et de monte-roulement / Set voor demontage en installatie van lagers

NEO  
TOOLS

50-88  
mm



Ref.	Ø [mm]	📦	EAN
11-690	50, 55, 60, 64, 67, 70, 72, 74, 75, 78, 82, 84, 88	1/2	5907558436624

NEO  
TOOLS

18-65  
mm



Ref.	Ø [mm]	📦	EAN
11-691	18, 19, 20, 21, 22, 23, 24, 25, 26, 27, 28, 29, 30, 31, 32, 33, 34, 35, 36, 37, 38, 39, 40, 41, 42, 43, 44, 45, 46, 47, 48, 49, 50, 51, 52, 53, 54, 55, 56, 57, 58, 59, 60, 61, 62, 63, 64, 65	1/1	5907558436631

## Przecinaki do nakrętek

Nut splitters / Meißel für Mutter / Гайноломы / Розривач до мутр / Csavaranyágók / Dălți pentru piulițe / Trháč matic / Trhače matic / Lomilci matic / Veržliji kirstukai / Uzgriežņu cirtņi / Meislid / Секачи за гайки / Rezač za matice / Sekač navrtanja / Κόφτες παξιμαδιών / Tajadera de tuercas / Spaccadadi / Cortadores de porcas / Burins à écrous / Moerknippers

NEO  
TOOLS



oczko 9 - 12 mm/klucz 12 mm  
9 - 12 mm nut splitter. Spaner drive shaft 12 mm  
размер гайки 9 - 12 мм / ключ 12 мм  
oczko 12 - 16 mm/klucz 14 mm  
12 - 16 mm nut splitter. Spaner drive shaft 14 mm  
размер гайки 12 - 16 мм / ключ 14 мм  
oczko 16 - 22 mm/klucz 19 mm  
16 - 22 mm nut splitter. Spaner drive shaft 19 mm  
размер гайки 16 - 22 мм / ключ 19 мм  
oczko 22 - 27 mm/klucz 21 mm  
22 - 27 mm nut splitter. Spaner drive shaft 21 mm  
размер гайки 22 - 27 мм / ключ 21 мм

Ref.	📦	EAN
11-925	0/10	5907558436945

## Zestaw nasadek

Socket set / Aufsatzset / Набор головок торцевых / Хабір насадок торцевих / Törtcsavarkihajtó készlet / Set duze / Sada násadek / Súprava nástr. klúčov / Garnitura nasadnih ključev / Antgalių rinkinys / Мисциу комплекси / Padrunikomplekt / Геодре номни / Šesterokutne kapice / Gedora set / Συλλογή καρυδακιών / Llaves de vaso / Set di boccole / Kit de bicos / Jeu de douilles / Set van doppen

NEO  
TOOLS

x16 1/2"



8, 10, 11, 12, 13, 14, 15, 16, 17, 19, 21, 22, 24, 27 mm  
2 wybijaki do usuwania śrub z nasadek  
2 x punches  
2 выколотки для снятия винтов с головок  
Można stosować z kluczami udarowymi  
Suitable for impact wrenches  
Можно использовать с ударными гайковертами  
Wewnętrzna spirala powoduje samoczynne zaciskanie się na uszkodzonej śrubie/nakrętce umożliwiając bezpieczne odkręcenie  
The innovative spiral profile digs itself into the head of a damaged screw/nut and thereby allows to loosen it securely  
Внутренняя спираль вызывает автоматическое зажатие поврежденного болта/гайки, обеспечивая безопасное откручивание

Ref.	📦	EAN
11-920	0/10	5907558436914

NEO  
TOOLS

x11 3/8"



9, 10, 11, 12, 13, 14, 15, 16, 17, 19 mm  
przetyczka 1 szt.  
1 x punches  
1 x штырь  
Wewnętrzna spirala powoduje samoczynne zaciskanie się na uszkodzonej śrubie/nakrętce umożliwiając bezpieczne odkręcenie  
The innovative spiral profile digs itself into the head of a damaged screw/nut and thereby allows to loosen it securely  
Внутренняя спираль вызывает автоматическое зажатие поврежденного болта/гайки, обеспечивая безопасное откручивание

Ref.	📦	EAN
11-922	0/20	5907558436938



## Indukcyjna grzałka do śrub

Induction bolt and screw heater / Induktives Heizgerät für Schrauben / Индукционный нагреватель / Нагрівач індукційний / Indukciós hevítő készlet / Incălzitor cu inducție pentru șuruburi / Indukční ohřev šroubů / Indukčný ohrievač pre skrutky / Indukcijski grelnik za vijake / Indukcinis šildytuvas varžtams / Indukcijas silātājs / Induktсион-пoldisoajendi / Индукционен нагревател за болтове / Indukcijski grijač za vijake / Indukcioni grejač za šrafove / Επαγωγικός θερμαντήρας / Calentador de inducción para tornillos / Riscaldatore ed induzione per viti / Aquecedor de indução para parafusos / Pistolet à chaleur inductive pour vis / Inductie dampelaar voor schroeven

NEO  
TOOLS

700°C 1200W

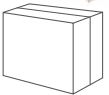
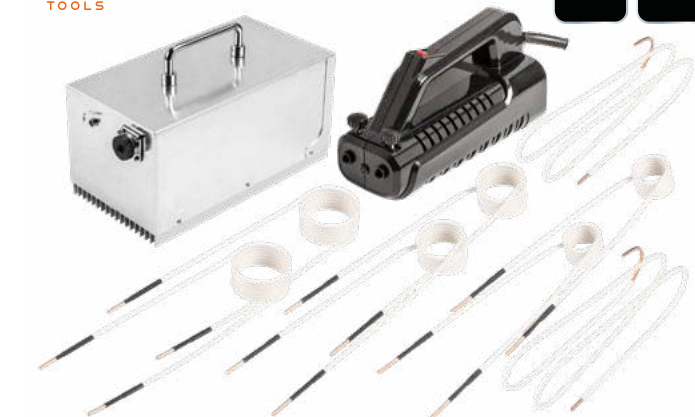

Ref.	📦	EAN
11-931	0/1	5907558436969

## Zestaw do naprawy gwintów

Thread repairing kit / Gewindereparatursatz / Набор для восстановления резьбы / Набор для відновлення гвинтованих з'єднань / Menejavitő készlet / Set de rectificat fileturi / Sada pro opravu závitů / Súprava na opravu závitov / Set za popravilo navojev / Srigigimo įrankių rinkinys / Skrivjuju remontkomplekts / Keerteraparanduskomplekt / Комплект за ремонт на резьба / Set za popravak navoja / Pribor za popravku šrafova / Σετ αποκατάστασης σπειρωμάτων μ5 / Juego de reparación de tornillos / Kit riparazione filetti / Jogo de ferramentas para reparacão de roscas / Kit de réparation de taraudages / Schroefdraad herstelset

NEO  
TOOLS

CrV  
steel

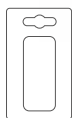

Ref.	Ø	📦	EAN
11-901	M6	10/40	5907558419870
11-902	M8	10/40	5907558419887
11-903	M10	10/40	5907558419894
11-904	M12	10/40	5907558419900

## Wkłady do naprawy gwintów

Thread repairing kit / Gewindereparatureinsätze / Набор резьбовых вставок / Набор для відновлення гвинтованих з'єднань / Menejavitő betét / Adausuri de rectificat fileturi / Vložky pro opravu závitů / Vložky na opravu závitov / Set za popravilo navojev / Srigigimo galvučių rinkinys / Leiktnji vitņu remontam / Keerteraparandustüübliid / Елементи за ремонт на резьба / Умeci за popravak navoja / Уметак за popravku / Σετ ένθετα σπειρωμάτων / Repuestos para reparación de tornillos / Kit riparazione filetti / Cartuxos para reparacão de roscas / Inserts de réparation de taraudages / Inzetdelen voor schroefdraad herstel

NEO  
TOOLS



Ref.	Ø	N	📦	EAN
11-905	M5	20	50/250	5907558419917
11-906	M6	20	50/250	5907558419924
11-907	M8	20	50/250	5907558419931
11-908	M10	20	50/250	5907558419948
11-909	M12	10	50/250	5907558419955

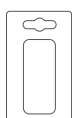

## Narzynki i gwintowniki

Tap and die set / Schneideisen und Gewindebohrer / Плашки и метчики / Позначники й плашки, набір / Menetkészítő készlet / Set scule tăiere filet interior și exterior / Závětnice a závětníky / Súprava závitníkov / Garnitura vreznikov in nareznikov navoja / Srigigijovės ir srigigikliai / Vītņgriežu komplekts / Kraani ja valuvormi komplekt / Метчици и плашки / Nareznice i ureznice set / Set ureznika i nareznika / Ελικόκοφτες και κολαούζα / Cojinetes y machos de roscar, juego / Madreviti e maschi / Cassonetes e roscas / Filières et tarauds / Snijplaat en schroefdraad snijtoestel

NEO  
TOOLS

x110



Ref.	📦	EAN
11-915	1/3	5907558436907

NEO  
TOOLS



M3-M12

DIN223

DIN352

32  
PCS

HSS

Ref.	📦	EAN
12-915		5907558483291

TOPEX

WOLFRAM



x20

DIN  
352

DIN  
223

Ref.	Ø [nr]	📦	EAN
14A425	M3-M12	10/20	5902062544186



## Narzynki i gwintowniki

Tap and die set / Schneideisen und Gewindebohrer / Плашки и метчики / Позначники и плашки, набор / Menetkészítő készlet / Set scule tăiere filet interior și exterior / Závítvice a závitníky / Súprava závitníkov / Garnitura vreznikov in nareznikov navoja / Sriegipjovės ir sriegikliai / Vītņgriežu komplekts / Kraani ja valuvormi komplekt / Μετчики и πλασκι / Nareznice i ureznice set / Set ureznika i nareznika / Ελικοκόφτες και κολαούζα / Cojinetes y machos de roscar, juego / Madreviti e maschi / Cassonetes e roscas / Filières et tarauds / Snijplaat en schroefdraad snijtoestel

**TOPEX**



WOLFRAM **x32**

DIN 352

DIN 223

Ref.	Ø [nr]	📦	EAN
14A426	M3-M12	0/16	5902062062024

## Gwintowniki

Taps / Gewindebohrer / Μετчики / Митчики / Menetűró készlet / Tarozí / Závitníky / Závitníky / Vrezniki navoja / Sriegtuvai / Vītņurbis / Кеертепуриid / Μετчици / Alati za rezanje navoja / Narezna svrdla / Ξυλοφάγος διάνοιξης απειρωμάτων / Machos de roscar / Filetti / Machos / Tarauds / Draadsnijtappen

**TOPEX**



WOLFRAM

**x21**

DIN 352

Ref.	Ø [nr]	📦	EAN
14A430	M3 - M12	0/20	5902062062031

**TOPEX**



DIN 352

WOLFRAM

Ref.	Ø	📦	EAN
14A203	M3	0/200	5902062060662
14A204	M4	0/200	5902062060679
14A205	M5	0/200	5902062060686
14A206	M6	0/200	5902062060693
14A208	M8	0/160	5902062060709
14A210	M10	0/100	5902062060716
14A212	M12	0/120	5902062060723

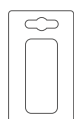

## Pokręto do gwintowników

Handle for hand tap / Gewindebohrergriff / Вороток для метчиков / Вороток для позначника / Menetűró hajtós / Manivelă burghiu manual / Vratidlo k závitníkům / Vratidlo na závitníky / Ročaj za vreznike navoja / Rankena sriegikliams / Vītņgriežu turētājs / Käsikraani käepide / Върток за метчик / Držac Ureznica / Okretac ureznika / Χειρολαβή για κολαούζα / Manivela para machos de roscar / Impugnatura per filetto / Chave para machos / Tourne-à-gauche / Draaiknop voor draadtap

**NEO TOOLS**



**T**

#45 STEEL

M3 - M8

HIGH STRENGTH

Ref.	📦	EAN
12-908	25/100	5907558483321

**NEO TOOLS**

M3 - M12

#45 STEEL

TWISTING FORCE

HIGH STRENGTH

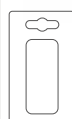

Ref.	📦	EAN
12-910	10/100	5907558483307

**TOPEX**

M3 - M12

**195 [mm]**

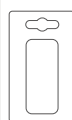

Ref.	L [mm]	📦	EAN
14A410	215	0/100	5902062060792

## Oprawka do narzynek

Handle for die / Schneideisenfassung / Вороток для плашек / Вороток для плашки / Menetűrszű hajtós / Míner filierä / Objímka závitnic / Vratidlo na očká / Ročaj za nareznike navoja / Sriegipjovės rėmas / Vītņgriežu turētājs / Valuvormi käepide / Върток за плашки / Držac nareznica / Okretac nareznika / Χειρολαβή για ελικοκόπτη / Terraaja de cojinetes / Impugnatura per filettatrice / Armadura p. Cassonetes / Monture de filière / Kader voor snijplaten

**NEO TOOLS**

M3 - M12

#45 STEEL

TWISTING FORCE

HIGH STRENGTH

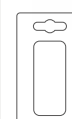

Ref.	📦	EAN
12-909	10/100	5907558483314

**TOPEX**

M3; M12 215mm

**210 [mm]**



Ref.	L [mm]	📦	EAN
14A420	230	0/100	5902062060587



## Narzynka

Die / Schneideisen / Плашка / Плашка / Menetmetsző / Filiera / Závrtová čelist / Závrtové očko / Nareznička navoja / Sriegpjavé / Vítngriezis / Valuvorm / Плашка / Nareznica / Nareznica / Ελικόκοπτης / Cojinetes de roscar / Filetatrice / Cassonete / Filière / Snijslaat

**TOPEX**



WOLFRAM  
**DIN 233**

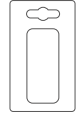

Ref.	Ø [nr]	☒	EAN
14A305	M5 [25x9mm]	100/200	5902062060822
14A306	M6 [25x9mm]	0/200	5902062060839
14A308	M8 [25x9mm]	10/0200	5902062060846
14A310	M10 [25x9mm]	0/200	5902062060853
14A312	M12 [25x9mm]	0/200	5902062060860

## Opaska ślimakowa

Hose clamp / Schneckenfelle / Хомут червячный / Хомут гвинтований / Tömlöbilincs / Brätaå cu melc / Šneková spona / Stahovacia páska kovová / Objemka na polža / Sqvarža / Gliemežsavilcijs / Toruklamber / Скоба с червячна резба / Обвјитка са ружним навоејем / Šelna / Οδοντωτός σφιγκτήρας σωλήνα / Bidas / Fascetta a vite / Abraçadeira caracol / Collier de serrage

**NEO TOOLS**



STAINLESS steel

**W4**

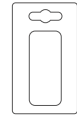

Ref.	Ø [mm]	N	☒	EAN
11-400	8-12 / 9 mm	x3	0/200	5907558420425
11-401	10-16 / 9 mm	x3	0/200	5907558420432
11-402	12-20 / 9 mm	x3	0/200	5907558420449
11-403	16-27 / 9 mm	x3	0/200	5907558420456
11-404	20-32 / 9 mm	x3	0/200	5907558420463

## TOPEX

**W2**

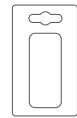
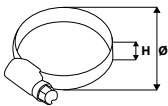

Ref.	Ø [mm]	H [mm]	☒	EAN
37D501	8-12	9	0/1000	5902062375018
37D502	10-16	9	0/1000	5902062375025
37D503	12-20	9	0/1000	5902062375032
37D504	16-25	9	0/1000	5902062375049
37D505	20-32	9	0/1000	5902062375056
37D506	25-40	9	0/500	5902062375063
37D507	32-50	9	0/500	5902062375070
37D508	40-60	9	50/500	5902062375087
37D509	50-70	9	0/500	5902062375094
37D510	60-80	9	50/500	5902062375100
37D511	70-90	9	0/250	5902062375117
37D512	80-100	9	0/250	5902062375124
37D513	90-110	9	0/250	5902062375131
37D514	100-120	9	25/250	5902062375148
37D515	110-130	9	25/250	5902062375155
37D516	120-140	9	0/250	5902062375162
37D517	130-150	9	0/250	5902062375179
37D518	140-160	9	0/250	5902062375186

**NEO TOOLS**

**x34**



Ref.	☒	EAN
11-981	0/20	5907558435764

## Szczypce do klipsów

Trim clip removal pliers / Trimmzange zum Entfernen des Clips / Плоскогубцы для удаления клипсы / Плоскогубцы для удаления клипсы / Végókarocs-eltávolító fogók / Clesti pentru scoaterea clemelor / Kleště na odstranění klipů / Kliešte na odstraňovanie spŕn / Kliešče za odstranjanje sponk / Sqvarža šalinimo replés / Klipu noņemšanas knaibles / Klambrite eemaldamise tangid / Клеци за премахане на клип / Kliešta za ukljanje isječka / Къешта за уклањане клипа / Πένσα αφαίρεσης κλιπ / Recorte alicates de extracción de clip / Pinza per tagliare clip / Alicates de remoção de cliques de acabamento / Pince pour enlever les clips / Tang voor verwijderen van clip /

**NEO TOOLS**



25 years  
GUARANTEED

35x35 mm

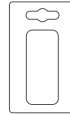

Ref.	☒	EAN
11-030	6/36	5907558445527

## Zestaw ściągaczy do tapicerki

Upholstery puller set / Lösehebel-Satz für Polster / Набор съемников панелей облицовки / Набор знімачів до обивки салону / Kárpiteszedő készlet / Set de scos piese de tapiterie / Sada pro demontáž čalunení / Súprava na demontáž čalúnenia / Set snemalcev oblažinjenja / Tvrtinimo elementu ištraukiklių / Tapsėjuma novilcėjū / Polstritõmmitsate / Комплект скоби за манипулация / Set za skidanje tapicerung / Pribor alata za skidanje tapetarskog materijala / Σετ εξολκείς πλακών επένδυσης / Juego de extractores de tapizado / Serie di utensili per interni / Conjunto de extratores para tapeçaria / Jeu d'extracteurs de tapisserie / Set van trekkers voor stoffering

**NEO TOOLS**



Ref.	☒	EAN
11-825	6/12	5907558436808

**NEO TOOLS**

NYLON



Ref.	N	☒	EAN
11-822	x5	6/24	5907558420029
11-823	x6	6/24	5907558420036
11-824	x11	0/10	5907558420043

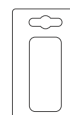



## Zestaw spinek samochodowych

Car pins / Auto-Körper-Clipsset / Клипсы крепления обшивки / Набор кліпс кріплення обшивки / Gépkocsi rögzítő patent készlet / Set de clipuri auto / Sada přichytek čalounění / Súprava sponiek do auta / Set avtomobilskih sponk / Automobilių tvirtinimo elementų rinkinys / Арşivuma stiprinājumi komplekts / Autotihvide komplekt / Комплект автомобильни щипки / Set spona za vozila / Komplet spojnice za automobile / Κλιπς ταπεταρίας / Kit de remaches de coche / Set di clip per carrozzeria / Luvas de nitrilo taranja / Ensemble d'épingles auto / Auto pinnen

**NEO**  
TOOLS



x300

OPEL

Ref. EAN  
11-952 0/28 5907558436990

**NEO**  
TOOLS



x345

PEUGEOT

Ref. EAN  
11-953 0/28 5907558437003

**NEO**  
TOOLS



x408

HONDA

Ref. EAN  
11-956 0/28 5907558437034

**NEO**  
TOOLS



x415

MITSUBISHI

Ref. EAN  
11-960 0/28 5907558437072

**NEO**  
TOOLS



x290

BMW

Ref. EAN  
11-961 0/28 5907558437089

**NEO**  
TOOLS



x360

TOYOTA  
LEXUS

Ref. EAN  
11-950 0/28 5907558436976

**NEO**  
TOOLS



x255

VOLKSWAGEN

Ref. EAN  
11-963 0/28 5907558437102

## Nity

Rivets / Niete / Закленки / Закленки / Alu popszegecs készlet / Nituri / Njty / Nity / Zakovice / Kniedes / Kniedes / Needitangid / Нитовое / Zakovice / Nitna / Πιραίαινα / Remaches / Rivetti / Rebites / Rivets / Klinknagels /

**NEO**  
TOOLS

AL x400



Ref. EAN  
11-970 2.4, 3.2, 4.0, 4.8 0/20 5907558437126



## Nakrętki samohamowne

Self-locking nuts / Selbstsichernde Muttern / Самоконтрянцяца гаўкі / Гаўкі самоконтркуючы / Ūnzáró anyák / Piulițe cu auto-blocare / Samosvorné matice / Samosvorné matice / Samozaporne matice / Savaiite užsifiksuojančios veržlės / Pašbremzėjošie uzgriežni / Iseblokeeruvad mutrid / Самозаконтрцяца гаўкі / Samokočive matice / Samokočne matice / Παξιμάδια αυτοσφραλιζόμενα / Tuercas autoblocantes / Dadi autobloccanti / Porcas autotravantes / Écrous freins / Zelfverschuilende moeren

NEO  
TOOLS

x146



Ref.	Ø [nr]	☒	EAN
11-972	M4 - M12	0/20	5907558437140

## Korki z uszczelkami miedzianymi

Drain plugs and coper pads / Verschlusschrauben mit Kupferdichtungen / Набор медных прокладок и пробок / Набор мідних прокладок і корків / Menetes dugó és rézalátét készlet / Buşoane cu garnituri din cupru / Zátky s měděným těsněním / Zátky s medenými tesneniami / Čepi za medeninastimi tesnili / Variniai kamščiai ir tarpinės / Vāciņi ar vara starplikām / Vasktindhēdīga korgid / Пробки за източване с медни уплътнения / Zatvarači s mesingastim brtvama / Komplet čepova sa bakarnim zaprtivcima / Σετ χάλκινων παρεμβυσμάτων και ταπών / Ταρones con juntas de cobre / Tappi con guarnizioni in rame / Tampões com anéis de cobre / Bouchons avec joints en cuivre / Krukken met messing dichting

NEO  
TOOLS

x534



Ref.	☒	EAN
11-974	0/10	5907558437164

## Podkładki miedziane

Coper pads / Unterlegscheiben aus Kupfer / Медные шайбы / Шайби мідні / Réz alátétek / Şaibe de cupru / Měděné podložky / Medené podložky / Medeninaste podložke / Varinēs tarpinēs / Vara starplikas / Vasest seibid / Медни шайби / Mesingasti podložci / Bakarne podložke / Χάλκινες ροδέλες / Arandelas de cobre / Rondelle in rame / Anéis de cobre / Rondelles en cuivre / Roestvrije onderringen

NEO  
TOOLS

x300

CU



Ref.	☒	EAN
11-971	0/10	5907558437133

NEO  
TOOLS

x150

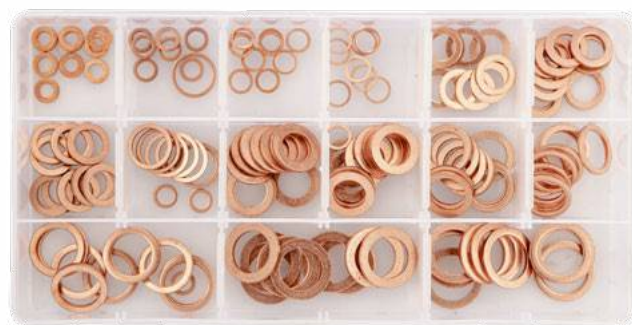

Ref.	☒	EAN
11-979	0/20	5907558435740

## Pierścienie segera

Seeger rings / Seeger-Ring / Стопорные кольца / Кільця стопорні / Seeger gyűrűk / Inele Seeger / Segerové kroužky / Segerove krúžky / Seger obroči / Žiedai Segera / Árėjeje un iekšėjeje sprostredzeni / Seeger ringid / Зеегерки / Uskočnici / Seger prstenovi / Δακτύλια συγκράτησης / Anillos seger / Anelli Seeger / Anéis Seeger / Anneaux élastiques / Seeger ringen

NEO  
TOOLS

x300

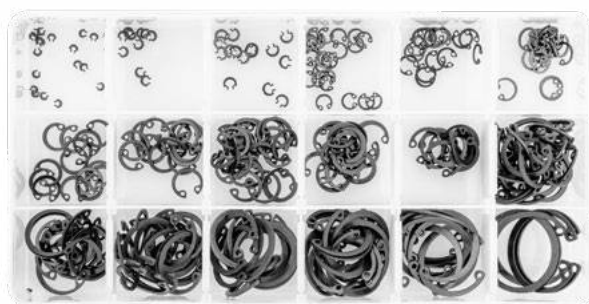

Ref.	☒	EAN
11-975	0/20	5907558437171

## Sprężyny

Springs / Federn / Пружини / Пружини / Rugó készlet / Arcuri / Pružiny / Pružiny / Vzmeti / Spyruoklių rinkinys / Atsperes / Vedrud / Пружини / Opruge / Opruge / Σετ ελατήρια / Espirales / Molle / Molas / Ressorts / Veren

NEO  
TOOLS

x200



Ref.	☒	EAN
11-980	0/20	5907558435757



## Koszulki termokurcziwie

Heat shrink sleeves / Wärmeschrumpfende Hüllen / Термоусадочные рукава / Рукави термоусадочни / Zsugorcsó készlet / Manşoane termocontractabile / Teplem smrštitelne rukávy / Teplom zmršťitelné návleky / Toplotno-skrčne spojke / Termiškai susitraukiančios rankovės / Termorucīgas uzmaņas / Termokahanevad sārgid / Термоусажаемы шлангу / Termo savitļivi rukavi / Rukavi koji se skupljamu na toploti / Θερμοσυστελλόμενα μονωτικά καλωδίων / Mangas termoencogibles / Guaine termorestringenti / Mangas termoretráteis / Gaines thermorétractables / Thermokrimp mouwen

**NEO**  
TOOLS

x127



Ref.	📦	EAN
11-978	0/20	5907558437201

## Uszczelki (O-ring NBR)

Seals (O-ring NBR) / Dichtungen (O-ring NBR) / Прокладки (O-ring NBR) / Прокладки (O-ring NBR) / Tömítés készlet (o-gyűrű nbr) / Garnhuri (O-ring NBR) / Těsnění (O-ring NBR) / Tesnenia (O-ring NBR) / Tesnila (O-ring NBR) / Tarpinės (O-ring NBR) / Blīves (O-ring NBR) / Tihendid (O-ring NBR) / Гарнитура (O-ring NBR) / Brtvila (O-ring NBR) / Zaptivke (O-ring NBR) / Ταμώμετες (O-ring NBR) / Juntas de calafateo (O-ring NBR) / Guarnizioni (O-ring NBR) / Vedantes (O-ring NBR) / Joints (O-ring NBR) / Dichtringen (O-ring NBR)

**NEO**  
TOOLS

x225



Ref.	📦	EAN
11-977	0/20	5907558437195

## Zestaw smarowniczek

Set of lubricating nipples / Ölerset / Набор маслёнок / Набор оливиць / Zsírözszem készlet / Set de căni de ungere / Sada mazniček / Súprava mazniček / Komplet mazalnic / Sutepimo dozatorių komplektas / Eļļas kanniņu komplekts / Māārdeprietside komplekt / Комплект рьчни маслёнчки / Set dozera za mazivo / Komplet maziva / Σετ ελαιοδεξαμενών / Juego de pistolas engrasadoras / Completo di punti di ingrassaggio / Kit de lubrificadores / Jeu de tubulure de graissage / Set van smeernippels

**NEO**  
TOOLS

x110



Ref.	📦	EAN
11-973	0/20	5907558437157

## Koszulki termokurcziwie "samolutujące"

Heat-shrink solder sleeves / Schrumpfschläuche / Термоусадочные трубки «самоустанавливающиеся» / Термоусадочні трубки «Самопайна» / Hőre zsugorodó, „önforrasztó” cső / Manşoane termocontractabile „auto-lipire” / Smršťovací „pájeci” spojky s cinem / Termozmršťovacie bužirky „samospájkovacie” / Termokrčljive mape / Karštjje susitraukiantys vamzdeliai / "Pašlodėjošas" termiskas sarausanās caurules / "Isejootvad" termokahanevad torud / Термосуваеми маркучы „самопаяваци” / "Samolemljive" termoskupljajuće košuljice / "Samolemljive" termoskupljajuće košuljice / Θερμοσυστελλόμενα μακαρόνια / Mangas termoencogibles / Guaine termorestringenti / Mangas termoretráteis / Gaines thermorétractables / Thermokrimp mouwen

**NEO**  
TOOLS

100 pcs  
0.25 - 6.0 mm



Ref.	📦	EAN
11-969	1/200	5907558471069

## Uszczelki (O-ring HNBR)

Seals (O-ring HNBR) / Dichtungen (O-ring HNBR) / Прокладки (O-ring HNBR) / Прокладки (O-ring HNBR) / Tömítés készlet (O-gyűrű hnbr) autóklimához / Garnhuri (O-ring HNBR) / Těsnění (O-ring HNBR) / Tesnenia (O-ring HNBR) / Tesnila (O-ring HNBR) / Tarpinės (O-ring HNBR) / Blīves (O-ring HNBR) / Tihendid (O-ring HNBR) / Гарнитура (O-ring HNBR) / Brtvila (O-ring HNBR) / Zaptivke (O-ring HNBR) / Ταμώμετες (O-ring HNBR) / Juntas de calafateo (O-ring HNBR) / Guarnizioni (O-ring HNBR) / Vedantes (O-ring HNBR) / Joints (O-ring HNBR) / Dichtringen (O-ring HNBR)

**NEO**  
TOOLS

x270



Ref.	📦	EAN
11-976	0/20	5907558437188

## Uszczelki

Seals / Dichtungen / Прокладки / Прокладки / Tömítések / Garnhuri / Těsnění / Tesnenia / Tesnila / Tarpinės / Blīves / Tihendid / Гарнитура / Brtvila / Zaptivke / Ταμώμετες / Juntas de calafateo / Guarnizioni / Vedantes / Joints / Dichtringen

**NEO**  
TOOLS

x419



Ref.	📦	EAN
11-983	1/20	5907558435788



## Zestaw do demontażu szyb

Car windows disassembling set / Abbausatz für Scheiben / Набор для демонтажа лобовых стекол / Набор для демонтажу вітрового скла / Szélvédő kiszerező készlet / Set pentru demontarea geamurilor / Souprava pro demontáž skel / Súprava na demontáž okien / Set za odstranitev stekel / Automobilių stiklų išmontavimo rinkinys / Autostiklu demontāžas komplekts / Tuuleklaasi eemaldamise komplekt / Комплект за демонтаж на автостъкла / Set za demontažu stakla / Pribor za demontiranje stakla / Σετ εξαγωγής παρμπριζ / Kit de desmontaje de ventanillas / Kit per lo smontaggio di cristalli / Kit de ferramentas de desmontagem de vidros / Kit de démontage de vitres

NEO TOOLS



Ref.	📦	EAN
11-819	1/10	5907558436792

## Miska magnetyczna

Magnetic tray / Magnetschüssel / Поддон магнитный / Піддон магнітний / Mágneses tál, rozsdamentes / Tava magnetica / Magnetická miska / Magnetická miska / Magnetna posoda / Magnetinis dubenėlis / Magnētiskais trauks / Magnetkauss / Магнитен картър / Magnetska posuda / Magnetna činija / Μαγνητικός δίσκος / Plato magnético / Vassoio magnetico / Tacho magnético / Récipient magnétique / Magnetische orangbak

NEO TOOLS



Ref.	L x W [mm]	📦	EAN
11-614	245 x 145	0/24	5907558419702

## Chwytnak magnetyczny

Magnetic holder / Magnetgreifer / Магнитный захват / Тримач магнітний / Mágneses csavarkiszedő teleszkópos / Graifjár magnetic / Magnetická úchytko / Magnetický zdvihák / Magnetno držalo / Magnetinis laikiklis / Magnētiskais satvērējs / Magnethaarats / Магнитен захват / Magnetska hvataljka / Magnētni hvatač / Μαγνητική αρπάγη / Agarrador magnético / Supporto magnetico / Saçamba magnética / Preneuse magnétique / Magnetisch houder

NEO TOOLS



Ref.	📦	EAN
11-610	0/200	5907558418569

NEO TOOLS

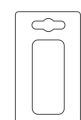

Ref.	📦	EAN
11-611	0/100	5907558418576

## Lusterko inspekcyjne

Inspection mirror / Inspektionspiegel / Зеркало инспекционное / Дзеркальце інспекційне / Vizsgálótükör teleszkópos nyéllal / Oglindă de inspecție / Zrcadlo pro inspekční kontroly / Inspekčné zrkadlo / Kontrolno ogledalo / Vaizdo veidrodelis / Inspekcijas spoguļis / Kontrollspiegel / Контролно огледалце / Kontrolno ogledalo / Ogljedalo za inspekciju / Καθρεπτάκι ελέγχου / Espejo de inspección / Specchietto per ispezione / Espelho de inspeção / Miroir d'inspection / Inspectiespiegel

NEO TOOLS



Ref.	📦	EAN
11-612	0/200	5907558418583

## Refraktometr

Refraktometer / Refraktometer / Рефрактометр / Рефрактометр / Refraktómetr / Refraktometru / Refraktometr / Refraktometer / Refraktometer / Refraktometras / Refraktometers / Refraktometer / Refraktometter / Рефрактометър / Refraktometar / Refraktometar / Διαλασίμετρο / Refractómetro / Rifraktometro / Refraktometro / Réfractomètre

NEO TOOLS



Ref.	📦	EAN
11-270	0/50	5907558436020

## Zestaw bezpieczników samochodowych

Car fuse / Set von Auto-Sicherungen / Набор автомобильных предохранителей / Набор запобіжників автомобільних / Gépkocsi biztosíték szett / Set de siguranțe auto / Sada pojistek do auta / Sada automobilových poistiek / Set avtomobilskih varovalk / Automobilių saugiklių rinkinys / Automobilių drošintąjai / Autokaitsmete komplekt / Комплект автомобильни предпазители / Set osigurača za auto / Komplet svećica za automobil / Σετ ασφάλειες αυτοκινήτου / Conjunto de fusibles de coche / Set di fusibili per auto / Kit de fusíveis de automóveis / Ensemble de fusibles auto / Auto bougies

NEO TOOLS

x88



Ref.	📦	EAN
11-993	0/20	5907558435818

NEO TOOLS

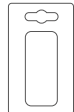

x10

Ref.	📦	EAN
11-991	50/200	5907558435795

NEO TOOLS

x10

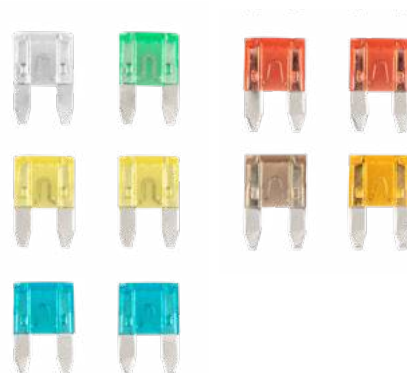

Ref.	📦	EAN
11-992	50/200	5907558435801



## Przewody rozruchowe

Booster cables / Akku-Zusatzleitungen / Стартовые провода / Шнури аварійного пуску акумулятора / Indítókábel réz / Conductor de avarie pentru acumulator / Kabely pro nouzové startování k akumulátoru / Pomocné káble do akumulátora pre núdzový štart / Vážalni kabli / Automobiliu ūvedimo laidai / Palašanas vadi akumulatoram / Aku avarijuhtmed / Аварийни проводници за акумулатора / Rezervni kablovi za akumulator / Hitni kabl za akumulator / Καλώδια έκτακτης ανάγκης για ηλεκτρικό συσσωρευτή / Cables puente para la batería / Cavi di emergenza per la batteria / Cabos de emergência para bateria / Câbles de démarrage pour batterie

**NEO**  
TOOLS



2.5m

Cu

Ref.	A max	☒	EAN
11-834	200	0/6	5907558436815
11-836	600	0/5	5907558436822

**TOPEX**

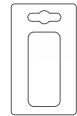

Ref.	P [A]	☒	EAN
97X250	400	0/20	5902062092526

## Urządzenie rozruchowe "Jumpstarter"

Boot device "Jumpstarter" / Startgerät "Jumpstarter" / Загрузочное устройство "Jumpstarter" / Завантажувальний пристрій "Jumpstarter" / Boot eszköz "Jumpstarter" / Dispositiv de pornire „Jumpstarter” / Spouštěcí zařízení „Jumpstarter” / Závádzacie zariadenie „Jumpstarter” / Zagonška naprava "Jumpstarter" / Įkrovos įrenginys „Jumpstarter” / Sākšanās ierīce "Jumpstarter" / Buutimisseade "Jumpstarter" / Стартово устройство "Jumpstarter" / Uređaj za pokretanje "Jumpstarter" / Уредјаз за покретање система "Јумпастартер" / Συσκευή εκκίνησης "Jumpstarter" / Dispositivo de arranque "Jumpstarter" / Dispositivo di avvio "Jumpstarter" / Dispositivo de inicialização "Jumpstarter" / Périphérique de démarrage "Jumpstarter" / Opstartapparaat "Jumpstarter"

**NEO**  
TOOLS

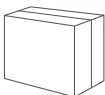

Ref.	☒	EAN
11-997	1/4	5907558452419

## Tester akumulatorów

Battery load tester / Batterietester / Тестер батареи / Тестер акумулатора / Akkumulátor tesztelő / Tester de încercare a bateriei / Tester baterii / Tester batterie / Tester akumulatorja / Akumulátorias baterijos testeris / Akumulatoru bateriju testeris / Aku tester / Тестер на батеријата / Ispitivač baterije / Испитивач батерије / Ελεγκτής φορτίου μπαταρίας / Comprobador de carga de batería / Tester di carico della batteria / Testador de carga da bateria / Testeur de charge de batterie / Acculaatester

**NEO**  
TOOLS



for  
6/12V  
batteries

100A

VOLTAGE  
ACCURACY  
±0.2V

ANALOG  
METER  
0-16 V DC

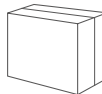

Ref.	A max	☒	EAN
11-984	100	1/10	5907558452402

**NEO**  
TOOLS



for all  
12V  
batteries

125A

VOLTAGE  
ACCURACY  
±0.2V

DIGITAL  
METER  
8-16 V DC

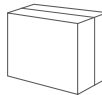

Ref.	A max	☒	EAN
11-985	125	1/10	5907558452419

**NEO**  
TOOLS



for all  
12V  
batteries



Ref.	☒	EAN
11-986	6/36	5907558452419



## Prostownik

Car battery charger / Stromrichter / Выпрямитель / Вупрямляч / Egyenirányító / Redresor auto / Usměřňovač / Usmerňovač / Usmernik / Įkroviklis / Akumulatora lādētājs / Alaldi / Τοκοισπρωμεν / Ispravljáč / Ispravljáč / Ανορθωτής / Rectificador / Raddrizzatore carica batterie / Gelijkrichter

**NEO**  
TOOLS



Ref.	[A/W]	Ah	☒	EAN
11-891	4/70	3-120	0/10	5907558463279
11-892	6/100	3-150	0/10	5907558463279
11-893	10/160	3-200	0/10	5907558463279

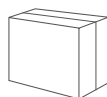

**NEO**  
TOOLS

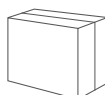

Ref.	☒	EAN
11-890	0/10	5907558463279



## Próbnik elektryczny samochodowy

Car voltage tester / Kfz-Spannungsprüfer V / Индикатор напряжения / Индикатор напруги автомобільний / Jármű fázisceruza / Sonda de luat probe la instalații electrice la automobile / Ζkoušečka napětí autoelektrikářská / Autoskušáčka / Preizkuševalac napetosti za avtomobile / Elektroninis testeris automobiliams / Automašinas elektrības testeris / Auto elektritester / Автомобилен фазомер / Električni ispitivač napona / Automobiliški električni tester / Συσκευή ένδειξης τάσης / Prbadador eléctrico para coches / Tester per auto / Testador de tensão para carros / Testeur électrique automobile / Elektrische wagen meetkop

**NEO**  
TOOLS



6-24V

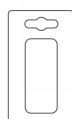

Ref.	☒	EAN
11-832	12/240	5907558420418

## TOPEX

24V



Ref.	U [V]	L [mm]	☒	EAN
39D081	6-24	115	12/240	5902062051226

## TOPEX

24V



Ref.	U [V]	L [mm]	☒	EAN
39D082	6-24	140	24/288	5902062051233

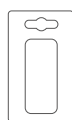

## Podnośnik przesuwny

Floor jack / Schiebeheber / Домкрат подкатной / Домкрат / Aluminium hydraulikus krokodilemelő / Cric de podea / Přenosný zvedák / Zdvíhák hydraulický vozík / Hidraulická dvíhalka / Domkratas / Pacelājs / Tungraud / Крук / Hidraulická auto dizalica / Hidraulická auto dizalica / Γρύλος τράλλει / Gato hidráulico / Sollevatore a carrello / Elevador de deslize / Cric mobile / Schuifhijstoestel

NEO  
TOOLS

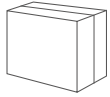

Ref.	[t]	☒	EAN
11-730	1.25	0/1	5907558416930

NEO  
TOOLS

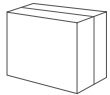

Ref.	[t]	☒	EAN
11-731	2.5	0/1	5907558416947

NEO  
TOOLS

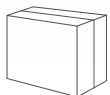

Ref.	[t]	☒	EAN
11-732	3.0	0/1	5907558436716

## Podnośnik słupkowy

Bottle jack / Säulenhebergerät / Домкрат гидравлический бутылочный / Домкрат пляшкови / Palackemelő / Cric coloană / Zvedák pístový / Stĺpkový zdvihák / Dvigalka / Hidraulinis keltuvus / Mastu pacelājs / Latt-tungraud / Колонен подежник / Stupna dizalica / Stubasta dizalica / Γρύλος υδραυλικός μπουκάλιας / Gato hidráulico de botella / Sollevatore a bottiglia / Elevador com colunas / Cric bouteille / Paalhijstoestel

NEO  
TOOLS



Ref.	[t]	H [mm]	☒	EAN
10-450	2	181-345	1/6	5907558470468
10-451	3	195-370	1/6	5907558470475
10-452	5	215-413	1/4	5907558470482
10-453	8	230 - 456	1/4	5907558470499
10-454	10	230-460	1/4	5907558470505
10-455	15	230-460	1/2	5907558470512
10-456	20	240-452	1/2	5907558470529

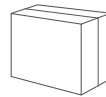

## Podnośnik warsztatowy

Shop crane / Werkstattheber / Внутримеховый кран / Кран гаражный / Műhelydarú, motorkiemelő zsíríz / Cric de atelier / Dílenský zvedák / Dílenský zdvihák / Dvigalka / Keltuvus dirbtuvėms / Profesionālais pacelājs / Töökojatungraud / Ποδηλασική / Radionička dizalica / Radionička dizalica / Γραρός για γραράζ / Gato de taller / Gruetta / Elevador de oficina / Vérin d'atelier / Werkplaats hijstoestel

NEO  
TOOLS

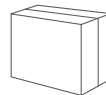

Ref.	[t]	H [mm]	☒	EAN
11-720	2	25-2382	0/1	5907558419665



## Podnośnik pneumatyczny

Air floor jack / Werkstattheber / Пневматический домкрат / Kran garażny / Pneumatikus légrámpás emelő / Cric de atelier / Dilenský zvedák / Dieleňský zdvihák / Dvigalka / Keltuvas dirbtuvėms / Profesionālais pacēlājs / Töökojatungraud / Повдизач / Radionička dizalica / Radionička dizalica / Γερανός για υπαράζ / Gato de taller / Cric da oficina / Elevador de oficina / Vérin d'atelier / Werkplaats hijstoestel

**NEO**  
TOOLS

3.5T  6-8 bar

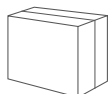

Ref.	[t]		EAN
11-735	3.5	0/1	5907558436723

## Podstawki pod samochód

Jack stands / Kfz-Unterlagen / Подставки автомобильные / Підставка під автомобіль / Emelő bak / Suport de ridicare / Podpěra panenka / Podpera panenka / Podstavki za hidravlično dvigalko / Automobilinis domkratas / Paliktinis zem auto / Tungraua alused / Стойка за кола / Držáč za auto dizalicu / Drzac za auto dizalicu / Γρύλος σταθερός / Soporte para coche / Cavalletti di sollevamento / Suporte para carro / Supports pour voiture / Autosteunen

**NEO**  
TOOLS

x2

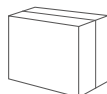
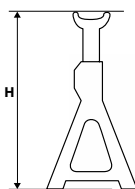



Ref.	[t]	H [mm]		EAN
11-750	3	295 - 415	1/1	5907558418361
11-751	2	278 - 423	1/1	5907558418378

## Wciągarka łańcuchowa

Chain block / Kettenwinde / Лебедка цепная / Тягль ланцюгова / Láncos emelő / Trolieu cu lant / Řetězový kladkostroj / Retázový zdvihák / Veržna dvigalka / Grandininė gervė / Κέδες νινča / Kettvintz / Верхня леебедка / Lančani podizač / Lančana dizalica / Βαρούλκο με αλυσίδα / Cabria de cadena / Paranco a catena / Guincho de corrente / Treuil à chaîne / Kettingtakel

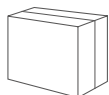
**NEO**  
TOOLS



Ref.	[t]	L [m]		EAN
11-760	1	3	0/1	5907558418385
11-761	2	3	0/1	5907558418392
11-762	3	3	0/1	5907558418408
11-763	5	3	0/1	5907558418415

**TOPEX**

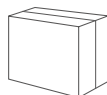



Ref.	Fmax [t]	 [kg]		EAN
97X072	2,0	11,0	1/1	5902062970725

## Wyciągarka linowa

Cable puller / Seilwinde / Лебедка канатная / Лебідка тросова / Racsnis huzató / Dispozitiv pentru întinderea cablului / Lanový vrátek / Naviják lanový / Vlečna jeklena vrv / Keltuvas / Trošu vinča / Kaablitõmmits / Лебедка / Sajla / Sajla / Βαρούλκο οαηαιού / Cabria de cable / Paranco a cavo / Guincho de corda / Treuil à levier à câble / Lijntakel

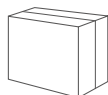

**TOPEX**

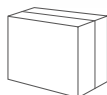

Ref.	Fmax [t]	 [kg]		EAN
97X080	2	3,1	0/6	5902062200211
97X082	3,5	5,9	0/2	5902062970824

**TOPEX**



Ref.	Fmax [t]	 [kg]		EAN
97X085	540	3,75	1/6	5902062970855
97X087	900	5,50	0/4	5902062970879





## Leżanka warsztatowa

Car creeper / Werkstattliege / Лежанка рабочая / Візок на роликах для / Роботи під автомобілем / Szerelőágy, összecusukható / Sezlong de atelier / Dílenská lehátka / Montážne ležadlo / Delavniški ležalnik / Sulankstoma lova, dirbtuvėms / Darba guļamkrēsls / Veerevalus / Монтёрско килмче / Radionička ležaljka / Radionički kauč / Ξαλώστρα συνεργείου / Camilla de taller / Lettino sottomacchina / Carrinho de oficina / Divan d'atelier / Werkplaatsbank

**NEO**  
TOOLS

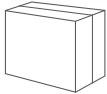

Ref.	m <sub>max</sub> [kg]	☒	EAN
11-600	150	0/1	5907558418347

## Prasa hydrauliczna

Hydraulic press / Hydraulische Presse / Гідравлический пресс / Прес аідралічний / Hidraulikus prés / Presă hidraulică / Hydraulický lis / Hydraulický lis / Hidravlična stiskalnica / Hidraulinis presas / Hidrauliskā prese / Hidrauliline press / Хідравлічна преса / Hidraulična preša / Hidraulična presa / Υδραυλική πρέσα / Prensa hidráulica / Pressa idraulica / Prensa hidráulica / Presse hydraulique

**NEO**  
TOOLS



**20T**  
**0-905 mm**

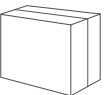

Ref.	☒	EAN
11-714	0/1	5907558436686

## Belka do podnoszenia silnika

Engine beam hoist / Balken zum Anheben des Motors / Балка для під'єма двигател'я / Балка для під'єому двигуна / Motoremelő gerenda / Bară pentru ridicarea motorului / Nosník pro zvedání motoru / Nosník na zavesenie motora / Dvigalka za avtomobilski motor / Variklio keltuvas / Sija motora pacelšanai / Mootori tõstmise tala / Γρεδα за повдигане на двигателю / Greda za podizanje motora / Greda za podizanje motora / Τραβέρσα ανύψωσης κινητήρων / Viga elevadora para el motor / Trave di sollevamento del motore / Viga elevadora do motor / Barre support moteur / Balk voor het heffen van de motor

**NEO**  
TOOLS

**CAPACITY 500 kg**  
**730-1480 mm WORKING RANGE**  
**0-205 mm ADJUSTABLE HEIGHT**

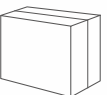

Ref.	☒	EAN
11-749	0/1	5907558459760

**NEO**  
TOOLS

**2in1**  
**40x14x102 / 54.5x40.5x48 cm**

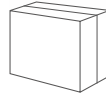

Ref.	m <sub>max</sub> [kg]	☒	EAN
11-601	150	1/1	5907558445282

## Stół warsztatowy

Work bench / Werkstattbank / Стол-верстак / Верстак / Állítható munkapad / Tejghea tímplárie / Dílenský stůl / Stůlček pracovný / Delavniška miza / Darbastalis / Darba galds / Τοόpink / Работна маса / Stol radionički / Radni sto / Πάγκος εργασίας / Banco de trabajo / Banco da lavoro / Mesa de oficina / Etabli d'atelier / Werkplaatstafel

**NEO**  
TOOLS

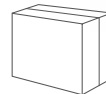

Ref.	[mm]	☒	EAN
11-716	1500 x 780 x 830 – 980 mm	0/1	5907558436693

## Stojak na silnik

Engin stand / Motorhalter / Стенд для ремонту двигател'я / Стенд для ремонту двигуна / Motorszerelő állvány / Stativ pentru motor / Stojan na motor / Stojan na motor / Stojalo za motor / Variklio stovas / Dzinēja remonta stativs / Mootoristend / Стойка за двигател / Stalak za motor / Stalak za motor / Βάση επισκευής κινητήρων / Soporte para motor / Cavalletto supporto motore / Suporte de motor / Support moteur / Motor onderstel

**NEO**  
TOOLS

**450kg**

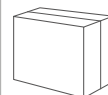

Ref.	☒	EAN
11-710	0/1	5907558436662



## Podnošník do skrzyń biegów

Transmission jack / Getriebeheber / Трансмисионная стойка / Стійка трансмісійна / Sebességváltó emelő / Cric pentru cutia de viteze / Zvedák převodovek / Zdvih prevodovky / Dvigalo za menjalnik / Pavarų dėžės keltuvai / Átrunkárbus domkrats / Käigukasti tungraud / Трансмиссионен подежник / Podizač mjenjača / Dizalica za mjenjač brzina / Σαμανόςρυλος / Elevador de caja de engranajes / Martinetto per scatole del cambio / Elevador da caixa de velocidades / Jack de transmission

**NEO**  
TOOLS



500kg  
min 0,9 m  
max 1,9 m

**NEO**  
TOOLS



0.5t  
1700mm MAX  
MIN 895mm

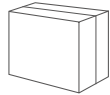

Ref. 11-712  
EAN 0/1 5907558436679

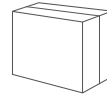

Ref. 11-711  
EAN 1/1 5907558445534

## Mata serwisowa na błotniki, magnetyczna

Car body servis cover, magnetic / Servicematten für Kotflügel, magnetisch / Накладка магнитная на крыло / Накладки магнітні до брызкошквів / Mágneses sárnyvédő takaró / Rogojini servicii pentru aripi, magnetice / Ochranné prehozy na blatníky, magnetické / Servisné rohože pre blatníky, magnetické / Servisne obloge za blatnike, magnetne / Apsauginė magnetinė danga ant sparno / Mašinas spērna magnētiskais paklājs instrumentiem / Porilaudade hooldusmatid, magnetilised / Магнитно покрывало за калници / Servisne mate za blatobrane, magnetske / Servisne podloge za branike, magnetne / Μαγνητική ποδιά φερού / Alfombras de servicio para guardabarros, magnéticas / Stuoie per manutenzione sui parafranghi, magnetiche / Coberturas magnéticas para para-lamas / Bâches de garde-boue magnétiques / Service matten voor spatlappen

**NEO**  
TOOLS



120x100 cm

**NEO**  
TOOLS



1000x630 mm

CAR WHEEL CUTOUT

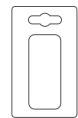

Ref. 11-718  
EAN 0/20 5907558436709

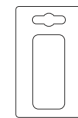

Ref. 11-719  
EAN 0/25 5907558459753

## Linka holownicza

Tow line / Abschleppseil / Трос буксировочный / Трос буксирувальний / Vontató kötél / Cablu de remorcare / tažné lano / vlečné lano / vlečná vrv / темпимо лынас / Vilkšanas trosė / νεοκόϊς / Въжє за тегленє / Sajla za vuču / Ужє за вуču / Συρματόσχοινο ρυμούλκησης / Cuerda para remolque / Cavo di traino / Corda de reboque / Corde de remorquage

**TOPEX**

2000 kg  
4m 14mm

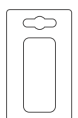

Ref. 97X269  
EAN 0/25 5902062972699

## Schodek do samochodu 3w1

3-in-1 car stepping tool / Autoeinstiegsstufe 3in1 / Лестница для автомобиля 3 в 1 / Сходи для автомобіля 3-в-1 / Fellérő gépkocsizhoz 3az1-ben / Treaptă pentru mașină 3 în 1 / Schodek k autu 3v1 / Schodík do auta / Stopnica za vozilo 3v1 / Automobilia laiptelis 3 viename / Pakāpieni trīs vienā automašīnai / Autoaste 3in1 / Бєгажннк 3в1 / Stupanj za vozilo 3u1 / Stepenica za automobil 3u1 / Σκαλοπάδι αυτοκινήτου 3 σε 1 / Escalón de coche 3 en 1 / Scalino per auto 3in1 / Degrau para carro 3 em 1 / Marche de voiture 3 en 1 / 3-In-1 autotrap / 3-i-i trinn for bil / Fotsteg till bil 3il / Porras autoon 3 in 13v1

**NEO**  
TOOLS



FITS MOST CARS  
3in1  
up to 230kg

Ref. 10-477  
EAN 1/50 5907558471120



## Wielowarstwowy pokrowiec na samochód

A multi-layer car cover / Mehrschichtige Autoabdeckung / Βαζατοσφαιρωγί αυτομωβιλίνιυ χωχολ / Многослойный автомобильный чехол / Többrétegű autónvédő / Husá auto multistrat / Včevrstvý potah na auto / Viacvrstvový potah na auto / Večplastna prevleka za avto / Kelių sluoksnių / Automobila pārsegs vairākos slāņos / Покривало за кола в няколко слоя / Κάλυμμα αυτοκινήτου πολλαπλών στρώσεων / Copertura per auto multistrato / Funda de coche multicapa / Housse de voiture en plusieurs couches / Cobertura de automóvel em várias camadas / Autohoes in meerdere lagen /

NEO  
TOOLS

4,3 x  
1,6 x  
1,2 m

2 layers  
waterproof

PEVA  
+ cotton  
+ waterproof  
belt



Ref.	Info	EAN
10-474	0/1	5907558471113

## Oszona na szybę

Windshield cover / Windschutzscheibenabdeckung / Віконна кришка / Чехол для лобового стекла / Szélvédőhuzat / Acoperire parbriz / Obal na čelní sklo / Obal na čelné sklo / Zaščita vetrobranskega stekla / Priekinio stiklo apsauga / Vėjstikla aizsargs / Протектор за предно стъкло / Προστατευτικό παρμπρίζ / Copri parabrezza / Funda de parabrissas / Protection de pare-brise / Protector de pára-brisas / Voorruitbeschermer

NEO  
TOOLS

1380  
x700  
mm

ALUMINIUM



Ref.	Info	Info	EAN
10-470	single insulating layer	1/30	5907558471076
10-471	double insulating layer	1/30	5907558471083

## Kuweta na narzędzia, silikonowa

Silicone screw cell small / Werkzeugablage, Silikon / Лоток для інструментів, силіконовий / Лоток для инструментов, силиконовый / Szerszámtálca, szilikon / Ταβήα pentru scule, silicon / Zásobník na nářadí, silikonový / Zásobník na náradie, silikónový / Pladenj za orodje, silikon / Įrankių dėklas, silikoninis / Instrumentu paliktis, silikona / Тава за инструменти, силикон / Δίσκος εργαλείων, σιλικόνη / Vaschetta per attrezzi, silicone / Bandeja de herramientas, silicona / Plateau à outils, en silicone / Bandeja de ferramentas, silicone / Gereedschapsbakje, silicone /

NEO  
TOOLS

MADE OF  
STRONG  
TPR  
SILICONE



Ref.	Info [mm]	Info	EAN
10-480	275 x 145 x 25	1/20	5907558471137
10-481	257 x 232 x 25	1/20	5907558471144
10-482	540 x 290 x 35	1/10	5907558471151

## Pokrowiec oddychający na motocykl / skuter

Breathable motorcycle/scooter cover / Atmungsaktive Motorrad-/Rollerabdeckung / Дышащий чехол для мотоцикла/скутера / Дыхающий чехол для мотоцикла/скутера / Lélegző motorkerékpár/robogó huzat / Acoperire respirabilă pentru motocicletă/scooter / Prodyšný obal na motocykl/skúter / Dihajoča prevleka za motorno kolo/skuter / Kvėpuojantis motociklo / motorolerio dangtis / Elpojošs motocikla/skūtera pārsegs / Дышащо покривало за мотоциклет/скутер / Αναπνεύσιμο κάλυμμα μοτοσικλέτας/μωχανής / Copri moto/scooter traspirante / Cobertura respirável de motocicleta/scooter / Funda transpirable para moto/scooter / Housse de moto/scooter respirante / Ademende motorfiets-/scooterhoes

NEO  
TOOLS



220x  
105x  
130 cm

waterproof  
breathable

black  
flat fabric

Ref.	Info	EAN
10-472	0/1	5907558471090

## Pokrowiec na motocykl / skuter

Motorcycle / scooter cover / Motorrad-/Rollerabdeckung / Чехол для мотоцикла/скутера / Чехол для мотоцикла/скутера / Motorkerékpár/robogó védőhuzat / Husá pentru motocicletă/scooter / Potah na motorku/skútr / Potah na motorku/skúter / Prevleka za motorno kolo/skuter / Motociklo / motorolerio dangtis / Motocikla/skūtera pārsegs / Покривало за мотоциклет/скутер / Κάλυμμα μοτοσικλέτας/σκούτερ / Copertura per moto/scooter / Funda para moto/scooter / Housse de moto/scooter / Cobertura de motocicleta/scooter / Motorfiets-/scooterhoes

NEO  
TOOLS

246  
x104  
x127cm

190 T  
poliester  
taffeta

waterproof  
resistant  
to UV 150°



Ref.	Info	EAN
10-473	0/1	5907558471106



## Zestaw narzędzi

Tool and socket set / Werkzeugsatz / Набор инструментов / Инструмент з насадками, набір / Szerszámkészlet / Set scule de grădină / Sada nářadí / Súprava náradia kombi / Garnitura orodij / Įrankių komplektas / Instrumentu komplekts / Tööriistade ja padrunite komplekt / Комплект инструментов / Set alata / Gedora set / Συλλογή εργαλείων / Juego de herramientas / Set di attrezzi / Kit de ferramentas / Jeu d'outils / Gereedschapsset

**NEO**  
TOOLS

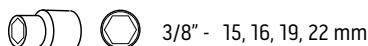

3/8" - 15, 16, 19, 22 mm



3/8" - E10, E11, E12, E14  
1/4" - E4, E5, E6, E7, E8



3/8" - 14, 16 mm

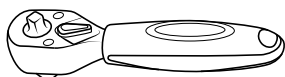

1/4" & 3/8" - 72T

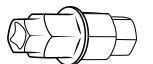

4 in 1: - 17, 19, 22, 24 mm



3/8" - T55

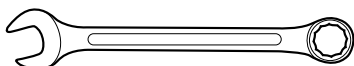

8, 10, 12, 14, 16, 17 mm



CrV  
steel

x25

1/4"

3/8"

1/2"

Ref. 10-500 EAN 5907558466317

## Narzędzie do osi motocyklowych

Motorcycle axle tool / Werkzeug für Motorrad-Achsen / Инструмент для оси мотоцикла / Инструмент для осей мотоцикла / Szerszám motorkerékpár tengelyekhez / Cheie hexagonală ax roata motocicletă / Přípravek na osy motocyklů / Náradie na motocyklové osi / Orodje za osi motocyklov / Motociklo ašijų įrankis / Motocicla ass říki trís vieniá / Mootorratta-teljätööriistad / Инструмент за мотоциклетни осу / Alat za osovine motocikla / Herramienta de eje de motocicleta / Utensile per assi delle moto / Ferramenta para eixos de motocicleta / Outil pour axe de moteur / As Inbus Zeskant voor motorfietsen

**NEO**  
TOOLS



**6in1** CrV steel FOR: YAMAHA  
12mm FOR: KTM front axis  
17mm FOR: BENELLI  
19mm FOR: KAWASAKI  
14mm FOR: YAMAHA XT660Z KAWASAKI ER-6N VERSYS XT660Z  
24mm FOR: BMW HONDA SUZUKI

Ref. 10-501 EAN 5907558466324

**NEO**  
TOOLS



**4in1** CrV steel  
17mm 19mm  
22mm 24mm

Ref. 10-502 EAN 5907558466331

**NEO**  
TOOLS



carbon steel **3in1**  
19mm 22mm  
24mm

Ref. 10-503 EAN 5907558466348

## Wskaźnik zegarowy GMP

GMP dial indicator / GMP-Uhranzeige / Индикатор часов GMP / Гдинниковий індикатор GMP / GMP órás indikátor / Indicator cadran GMP / Úchylkoměr pro nastavení předstihu / Hodinový ukazovateľ GMP / Merilna ura GMP / Laikrodinis viršutinio mirties taško indikatorius / GMP pulksteņa indikators / GMP-numbrinādik / GMP часовников индикатор / Satni indikator GMP / Satni indikator GMP / Indicator de dial GMP / Comparatore GMP / Relógio comparador GMP / Indicateur à cadran GMP / GMP wijzerplaat indicator

**NEO**  
TOOLS



CrV  
steel



Ref. 10-504 EAN 5907558466355



## Zestaw narzędzi do zakuwania i rozkuwania łańcucha

Chain crimping and uncrimping set / Set zum Crimpen und Entcrimpen von Ketten / Набор для обжима и разжима цепи / Набор для обтиску та розтиску ланцюга / Láncfűző és -bontó készlet / Set de sertizare și degajare a lanțului / Sada na krimpování a rozplétání řetězu / Súprava na krimpovanie a odskrutkovanie reťaze / Komplet za stiskanje in odpenjanje verige / Grandinių užspaudimo ir atspaudimo rinkinys / Kėdes presėšanas un atpresėšanas komplekts / Tööriistade komplekt keti kokkpressimiseks ja katkestamiseks / Комплект инструменти за спирачни цилиндри / Set alata za kočione cilindre / Комплект алата за коционе цилиндри / Juego de herramientas para cilindros de freno / Set di attrezzi per cilindri dei freni / Conjunto de ferramentas para cilindros de travão / Jeu d'outils pour cylindres de frein / Gereedschapset voor remcilindersator

NEO  
TOOLS



FOR CHAIN  
SIZES:  
520, 525  
530, 532

INCLUDES  
PINS SIZES:  
3, 4, 5  
mm

Ref. EAN  
10-505 1/10 5907558466362

## Zestaw narzędzi do cylinderków hamulcowych

Tool set for brake cylinders / Werkzeugsatz für Bremszylinder / Набор инструментов для тормозных цилиндров / Набор инструментов для гальмієних циліндрів / Szerszámkészlet fékhengerekhez / Set de unelte pentru cilindri de frână / Sada nářadí na brzdové válce / Súprava nástrojov na brzdové valce / Komplet orodja za zavorne cilindre / Stabdžių cilindrių įrankių rinkinys / Instrumentu komplekts bremžu cilindriem / Tööriistakomplekt pidurisilindrite jaoks / Комплект инструменти за спирачни цилиндри / Set alata za kočione cilindre / Комплект алата за коционе цилиндри / Juego de herramientas para cilindros de freno / Set di attrezzi per cilindri dei freni / Conjunto de ferramentas para cilindros de travão / Jeu d'outils pour cylindres de frein / Gereedschapset voor remcilindersator

NEO  
TOOLS



12  
adapters

Ø  
19-30  
mm

Ref. EAN  
10-506 1/5 5907558466379

## Narzędzie do rozkuwania łańcucha

Motorcycle chain cutter / Motorrad-Kettenschneider / Мотоциклетная цепь / Розрізувач ланцюга мотоцикла / Motorkerékpár láncvágó / Mašínä de täiat lančuri de motocicletä / Motocyklový řezák řetězu / Reťazový rezač na motocykel / Rezalnik verige motornega kolesa / Motociklo grandinės pjoviklis / Motocikla kėdes griežėjs / Mootorratta ketilõikur / Резец за мотоциклетна верига / Rezač lanca motocikla / Реzач ланца мотоцикла / Κόφτης αλυσίδας μοτοσικλέτας / Cortacadenas para motos / Tagliacatena per moto / Corrente de motocicleta cutter / Coupe-chaîne de moto / Kettingsnijder voor motorfietsen

NEO  
TOOLS

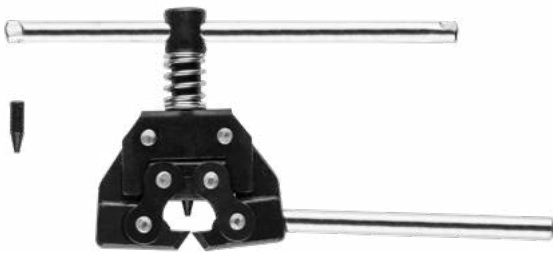

FOR CHAIN  
SIZES:  
415, 420  
423, 428

Ref. EAN  
10-510 1/50 5907558466416

NEO  
TOOLS

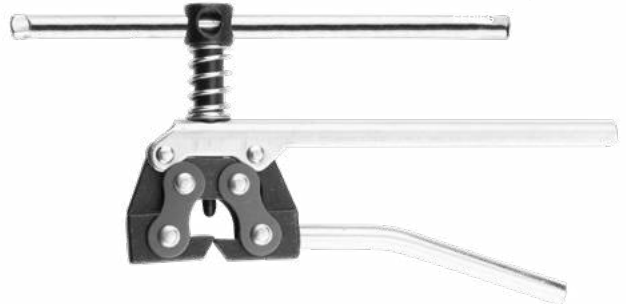

FOR CHAIN  
SIZES:  
520, 525  
530, 532

Ref. EAN  
10-511 1/30 5907558466423

## Nylonowa szczotka do czyszczenia łańcucha

Chain cleaning nylon brush / Nylon-Bürste für die Reinigung der Kette / Нейлоновая щетка для очистки цепи / Нейлонова щітка для чищення ланцюга / Nylon láncisztító kefe / Perie de nylon de curățat lanțuri / Nylonový kartáč na čišťení řetězu / Nylónová kefa na čistenie reťaze / Najlonska krtača za čiščenje verige / Nailoninis grandinės valdymo šepetys / Neilona birste kėdes tirišanai / Nailonist ketipuhastuhari / Нейлонова четка за почистване на верига / Najlonska četka za čiščenje lanca / Najlonska četka za čiščenje lanca / Βούρτσα καθαρισμού αλυσίδας από νάilon / Cepillo de nylon para limpiar cadenas / Spazzola in nylon per la pulizia di catene / Escova de nylon para limpeza de correntes / Brosse pour chaîne en nylon / Nylonborstel voor het reinigen van kettingen

NEO  
TOOLS



CHAIN  
CLEANING

NYLON  
BRISTLES

U  
TYPE



Ref. EAN  
10-509 1/100 5907558466409

## Szczypce do wyciągania tłoczków hamulcowych

Brake piston retractors / Zange für das Herausnehmen der Bremskolben / Съемник для тормозных цилиндров / Плоскозубиця для зняття гальмієних поршнів / Fékdugattyúk kihúzására szolgáló fogó / Clește pentru extragerea pistoanelor de frână / Kleště na vytažení brzdových pístů / Klešte na vytahovanie brzdových piestov / Klešče za odstranjevanje zavornih batnic / Stabdžių stūmoklių traukimo žnyplės / Knaibles bremžu virzūlu noņemšanai / Pidurikalbide eemaldamise tangid / Клеуци за изваждане на спирачни бутала / Klijesta za skidanja klipova kočnica / Klešta za skidanje klipova kočnica / Πένσα αναίγματος εμβόλων φρένων / Pinzas para retirar pistones de freno / Pinze per l'estrazione dei pistoncini dei freni / Alicata de remoção do pistão do travão / Pinceaux pour retirer les pistons de freins / Remzuiger-demontagetang

NEO  
TOOLS



CrV  
steel

Ø  
16.5mm  
-38mm

Ref. EAN  
10-507 1/20 5907558466386



## Zestaw kluczy do szprych motocyklowych

Motorcycle spoke wrench set / Motorrad-Speichenschlüsselsatz / Набор гаечных ключей для мотоциклетных спиц / Набор гаечных ключей для мотоциклов / Motorkerékrár kúllökücsészlet / Set de chei pentru raze de motocicletă / Sada klíčů na motocyklové paprsky / Sada klíčův na špice motocyklov / Garnitura ključev za kolesa z naperami za motorna kolesa / Motociklo veržliarakių rinkinys / Motociklu spēķļu atslēgu komplekts / Mootorratta mutrivõtmete komplekt / Комплект ключов за спици на мотоциклет / Set ključeva za žbice motocikla / Комплект ключев за мотоцикле / Σετ κλειδιών ακτίνων μοτοσυκλέτας / Juego de llaves de radios de moto / Set di chiavi a raggi per moto / Conjunto de chaves de boca de moto / Jeu de clés à rayons pour motos / Motorfiets spaaksleutelset

NEO  
TOOLS



9 psc 5.4 mm 5.6 mm 5.8 mm 6.0 mm 6.2 mm

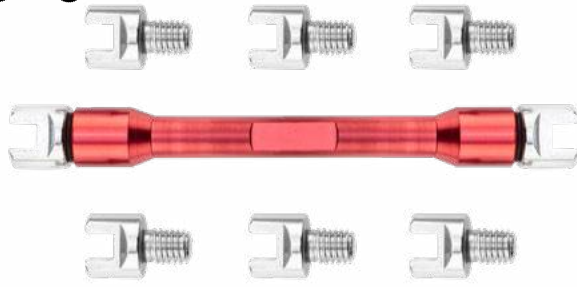

6.4 mm

6.6 mm

6.8 mm

Ref. 10-508    Info 1/60    EAN 5907558466393

## Nasadka nakrętki zawieszenia - Suzuki

Suzuki suspension nut socket / Aufsatz für Aufhängung-Mutter - Suzuki / Крышка гайки для подвески - Suzuki / Nasadka łańki podoicku - Suzuki / Dugókulcs felüggesztés anyához - Suzuki / Сарап піулітї suspensie - Suzuki / Násadka matice odpružení - Suzuki / Nadstavec matice zaveseňia - Suzuki / Nastavek za matico vzmetenja - Suzuki / Pakabos veržlės dangtelis - Suzuki / Piekares uzgriežņa uzgalis - Suzuki / Vedrustusnutri kork - Suzuki / Кавачка на гаїката на окачането - Suzuki / Капа навртке ovjesa - Suzuki / Profil navrtke trapa - Suzuki / x / Tapa de la tuerca de suspensión - Suzuki / Bussola per dado della sospensione - Suzuki / Tampa da porca de suspensão - Suzuki / Douille de l'écrou de suspension - Suzuki / Kap voor ophangingsmoer - Suzuki

NEO  
TOOLS



DESIGNATED FOR: SUZUKI 4mm 5mm 8mm



Ref. 10-585    Info 1/60    EAN 5907558466935

## Zestaw narzędzi do łożysk kół do Harley'a-Davidsona

Harley-Davidson wheel bearing tool kit / Radlager-Werkzeugsatz für Harley-Davidson / Набор колесных подшипников для Harley-Davidson / Набор инструментов для подшипников колес Harley-Davidson / Kerécsapágy szerszámkészlet Harley-Davidsonhoz / Set de scule pentru rulmenți de roți pentru Harley-Davidson / Sada nástrojů na ložiska kol pro Harley-Davidson / Súprava náradia na ložiská kolies Harley-Davidson / Set orodij za ležaje za kolesa Harley-Davidson / Įrankių rinkinys „Harley-Davidson“ ratų guoliams / Harley-Davidson riterų gultņu instrumentu komplekts / Harley-Davidsoni rattalaagrite tööriistade komplekt / Комплект инструменти за лагери на колелата за Harley-Davidson / Set alata za ležajevе kотаča za Harley Davidson / Set alata za ležajevе točkova Harley Davidson / Σε εργαλείων ρουλεμάν τροχών για Harley-Davidson / Kit de herramientas para rodamientos de ruedas de Harley-Davidson / Kit di attrezzi per cuscinetti delle ruote per Harley-Davidson / Kit de ferramentas para rolamentos de rodas de Harley-Davidson / Ensemble d'outils pour paliers des roues Harley-Davidsona / Gereedschapset voor wiellagers van Harley-Davidson

NEO  
TOOLS



CrV steel

TRAVEL CASE

DESIGNATED FOR: HARLEY DAVIDSON

3/4" - 1" 2000-2006 MODELS

25mm 2007-2008 MODELS ABS/NO-ABS

Ref. 10-586    Info 1/2    EAN 5907558466942

## Klucz hakowy

Hook wrench / Rohrzange / Ключ трубный / Ключ для круглых шлицевых гаек / Univerzális csőfogó / Cheie secera / Hákový klíč / Hákový klíč / Ključasti ključ / Raktas-kablys / Αγκείδα uzgriežņu atslēga / Haakvöti / Ключ за за кръгли шлицеве гаїки / Kukasti ključ / Kukasti ključ / Γαλλικό κλειδί / Llave de gancho / Chiave a gancio / Chave de gancho / Clé à crochet / Haaksleutel

NEO  
TOOLS



Ref.	Info []	Info	EAN
10-569	16-20	1/100	5907558466775
10-570	25-28	1/50	5907558466782
10-571	30-32	1/50	5907558466799
10-572	34-36	1/50	5907558466805
10-573	40-42	1/50	5907558466812
10-574	45-50	1/50	5907558466829
10-575	52-55	1/50	5907558466836
10-576	58-62	1/25	5907558466843
10-577	68-75	1/25	5907558466850
10-578	80-90	1/15	5907558466867
10-579	95-100	1/15	5907558466874
10-580	110-115	1/10	5907558466881
10-581	120-130	1/10	5907558466898
10-582	135-145	1/20	5907558466904
10-583	155-165	1/20	5907558466911

## Ściągacze do kół zamachowych

Flywheel pullers / Schwungradabzieher / Съемники маховиков / Знімачі маховиків / Húzószerszámok lendkerékhez / Extractoare de volante / Stahováky setrvačníků / Stáňovač na zotrvačníky / Orodje za snemanje vztrajnika / Smagračič nuemikliai / Spararata savilcėji / Hooratta tömmitsad / Издърпаочи за маховици / Izvekači za zamašnjak/zvekači zamajca / Εξολκείας βολών / Extractor de volante de inercia / Estrattori a volano / Extratores de volante / Outils pour enlever la roue d'inertie / Vliegwieltrekkers

NEO  
TOOLS



Right threads: M14 x P1,5;  
M16 x P1,5; M18 x P1,5;  
M19 x P1,0;  
M20 x P1,0; M22 x P1,0;  
M22 x P1,5; M24 x P1,0;  
M25 x P1,5;  
M26 x P1,0; M26 x P1,5;  
M28 x P1,0; M27 x P1,25;  
M28 x P1,5;  
Left threads - M27 x P1.0



carbon steel

x10

Ref. 10-584    Info 1/5    EAN 5907558466928

## Blokada kosza sprzęgła

Clutch cage retainer / Kupplungskorbsschluss / Ключ-блокировка корзины сцепления / Фиксація ношика зчеплення / Kuplungkosár-zár / Blocare coș ambreiaj / Кліч на spojkovú koš / Blokada koša spojky / Blokada koša / Sankabos dėžės užraktas / Sažūga graza slėdzene / Sidurikorvi lukk / Заключоване на ноша на съединителя / Blokada košarice kvačila / Blokada košarice kvačila / Εργαλείο συγκράτησης καμπάνας συμπλέκτη / Bloqueo de la jaula del embrague / Blocco cestello fizione / Bloqueo do cesto de embraiagem / Outil de verrouillage du panier d'embrayage / Koppelingsmandblokkade

NEO  
TOOLS



5/9mm

Ref. 10-587    Info 1/20    EAN 5907558466959

## Zestaw narzędzi do montażu i demontażu łożysk główki ramy w motocyklach

Motorbike head frame bearing installation and removal tool kit / Werkzeugsatz für die Montage und Demontage von Motorradkopfagern / Набор инструментов для установки и снятия подшипников головной рамы мотоцикла / Набор інструментів для встановлення та зняття підшипника головної рами мотоцикла / Motorkerékprár felszerelési és eltávolítási szerszámkészlet / Kit de instrumente de instalare și demontare a rulmenților pentru montarea și demontarea cadrului capului motocicletei / Sada nástrojů pro montáž a demontáž ložisek rámu hlavy motocyklu / Súprava nástrojov na montáž a demontáž ložiska rámu hlavy motocykla / Komplet orodij za namestitve in odstranitev ležaja okvirja glave motornega kolesa / Motociklo galvos rėmo guolių montavimo ir nuėmimo įrankių rinkinys / Motocikla galvas rāmja gultņu uzstādīšanas un noņemšanas instrumentu komplekts / Tööriistade komplekt mootorrattaste roolipea laagrite paigaldamiseks ja eemaldamiseks / Комплект інструментів за монтаж і демонтаж на лезер на рамата на мотоциклета / Set alata za montažu i skidanje ležajeva glave upravljajuća na motociklima / Kit εργαλείων εγκατάστασης και αφαίρεσης ρουλεμάν πλαισίου κεφαλής μοτοσικλέτας / Kit de herramientas para la instalación y el desmontaje de los rodamientos del cuadro de la moto / Kit di strumenti per l'installazione e la rimozione dei cuscinetti del telaio della moto / Kit de ferramentas de instalação e remoção de apoios de cabeça de motocicleta / Kit d'outils de montage et de démontage des roulements du cadre de la tête de la moto / Motorfiets hoofdframe lager installatie en verwijdering gereedschapset

NEO  
TOOLS



TYPE  
T  
HANDLE

7  
psc  
adapters

DIAMETER  
SIZES:  
32-46  
mm

Ref. 10-588  
EAN 5907558466966

## Wyważarka statyczna do kół motocyklowych

Static motorcycle wheel balancer / Statische Motorrad-Radauswuchtmaschine / Статический балансировщик колес мотоцикла / Балансир статичний для коліс мотоцикла / Statikus motorkerékprár kerékkiegyensúlyozó eszköz / Echilibrator de roți statice pentru motociclete / Statická vyvažovačka kol motocyklu / Statická vyvažovačka kolies motocykla / Statična izravnalna naprava za kolesa motornih koles / Statinis motociklo ratų balansavimo įtaisas / Statiskais motocikla riteņu balansieris / Staatlīne tasakaalustaja mootorrattaste jaoks / Статичен балансир за колела на мотоциклет / Statički uređaj za balansiranje kotača motocikla / Статични баланс точкова за точкове мотоцикала / Στατική εξισορρόπηση για τροχούς μοτοσικλετών / Equilibrador estático de ruedas de moto / Equilibratore statico della ruota della moto / Roda de motocicleta estática balancer / Équilibreur statique de roue de motocyclette / Statische motorfiets wiel balancer

NEO  
TOOLS



14-28  
mm  
AXIS

max  
21"

3,9  
kg

Ref. 10-590  
EAN 5907558466980

## Mobilny podnośnik hydrauliczny do quadów i motocykli

Mobile hydraulic jack for quads and motorbikes / Mobilier hydraulischer Wagenheber für Quads und Motorräder / Мобильный гидравлический домкрат для квадроциклов и мотоциклов / Мобільний гідравлічний домкрат для квадроциклів та мотоциклів / Mobil hidraulikus emelő quadokhoz és motorkerékpárokhoz / Cric hidraulic mobil pentru quad-uri și motociclete / Mobilní hydraulický zvedák pro čtyřkolky a motocykly / Mobilný hydraulický zdvihač pre štvorkolky a motocykle / Mobilni hidravlični dvigalo za štirikolesnike in motorna kolesa / Mobilus hidraulinis keltuvas keturračiams ir motociklams / Mobilais hidrauliskais domkrats kvadracikiem un motocikliem / Mobilne hüdrauliline tungraud nelikutele ja mootorrattaste / Мобилен хидравличен повдигач за четириколки и мотоциклета / Mobilna hidraulička dizalica za quadove i motocikle / Мобилна хидраулична дизалица за квад и мотоцикле / Κινητός υδραυλικός γρύλος για quads και μοτοσικλέτες / Gato hidráulico móvil para quads y motos / Martinetto idraulico mobile per quad e moto / Macaco hidráulico móvel para quads e motocicletas / Cric hydraulique mobile pour quads et motos / Mabele hydraulische krik voor quads en motoren

NEO  
TOOLS



up to  
680kg

27  
kg

MAX  
375  
mm  
H  
min  
115  
mm



Ref. 10-596  
EAN 5907558467048

## Stojak motocyklowy pod przednie koło

Motorcycle front wheel stand / Vorderradständer für Motorräder / Стойка переднего колеса мотоцикла / Підставка для передніх коліс мотоцикла / Motorkerékprár első kerékállvány / Suport pentru roata din față a motocicletei / Stojan na přední kolo motocyklu / Stojan na predné koleso motocykla / Stojalo za sprednje kolo motornega kolesa / Priekinis motociklo ratų stovas / Motocikla priekšējo riteņu statīvs / Mootorratta esiratta statiiv / Предна стойка за колело на мотоциклет / Stalak za motocikl ispod prednjeg kotača / Сталак за мотоцикле испод предњег точна / Στήριγμα μπροστινού τροχού μοτοσικλέτας / Caballete de rueda delantera de moto / Cavalletto anteriore per moto / Suporte da roda dianteira da motocicleta / Béquille de roue avant de motocyclette / Motorfiets voorwielstandaard

NEO  
TOOLS



19"  
7-13cm

up to  
680kg



Ref. 10-602  
EAN 5907558467109



## Przyrząd do demontażu i montażu kół motocyklowych

Tool for dismantling and mounting motorbike wheels / Werkzeug für die Demontage und Montage von Motorradrädern / Инструмент для демонтажа и монтажа колес мотоцикла / Инструмент для демонтажу і монтажу мотоциклетних коліс / Szerszám motorkerékpár kerekek le- és felszereléséhez / Unealtă pentru demontarea și montarea roților de motocicletă / Nástroj na demontáž a montáž kol motocyklu / Nástroj na demontáž a montáž kolies motocykla / Orodje za demontážo in montažo koles motornega kolesa / Irankis motociklo ratams išmontuoti ir sumontuoti / Instruments motociklu ritepu demontāžai un montāžai / Tööriist mootorratta rataste lahtivõtmiseks ja kokkupanemiseks / Инструмент за демонтиране и монтиране на колела на мотоциклети / Alat za demontážu i montažu kotača motocikla / Alat za demontážu i montažu tpochnoa motocykla / Εργαλείο για την αποσυναρμολόγηση και τοποθέτηση τροχών μοτοσικλέτας / Herramienta para desmontar y montar las ruedas de la moto / Attrezzo per smontare e montare le ruote della moto / Ferramenta para desmontagem e montagem de rodas de motos / Outil pour le démontage et le montage des roues de motos / Gereedschap voor het demonteren en monteren van motorfietswielen

NEO  
TOOLS



12"-20"

7kg

Ref.	☒	EAN
10-606	0/1	5907558467147

## Chusteczki ze ścierniwem do mycia rąk oraz czyszczenia powierzchni i narzędzi

Abrasive grit wipes for cleaning hands, surfaces and tools. / Scheuertücher zum Händewaschen und Reinigen von Oberflächen und Werkzeugen / Абразивные салфетки для мытья рук, очистки поверхностей и инструментов. / Абразивні серветки для миття рук, очищення поверхонь та інструментів / Súlyoszeres törölkendők kézmosáshoz, valamint felületek és szerszámok makacs szennyeződésektől való megtisztításához / șervețele abrazive pentru spălarea mâinilor și curățarea suprafețelor și a uneltelor / abrazivni ubrusky na mytí rukou a čištění povrchů a nářadí / Utiěrky s abrazívnou zložkou na čistenie rúk a čistenie povrchov a nástrojov / čistilni brusilni robčki za čiščenje rok, površin in orodij / Abrazivines servetelés rankoms plauti ir paviršiams bei įrankiams valyti / Abrazivas salvetes roku tīrīšanai, kā arī virsmu un instrumentu tīrīšanai / Abrasiivaineiga rätikud käte pesemiseks ning pindade ja tööriistade puhastamiseks. / Кърпички с абразив за измиване на ръце и почистване на повърхности и инструменти. / maramice s abrazivom za pranje ruku i čišćenje površina i alata / maramice sa abrazivom za pranje ruku i čišćenje površina i alata. / Λειαντικά μαντήλια για πλύσιμο χεριών και καθαρισμό επιφανειών και εργαλείων / toallitas con abrasivos para lavar las manos y limpiar las superficies y herramientas / fazzoletti con abrasivo per lavare le mani e pulire le superfici e gli strumenti di lavoro / Toalhetes com abrasivo para lavar mãos e limpar superfícies e ferramentas / lingettes abrasives pour le lavage des mains et le nettoyage de surfaces et d'outils. / schurende doekjes voor het wassen van de handen en het reinigen van oppervlakken en gereedschap

NEO  
TOOLS



Ref.	☒	EAN
10-408	1/0	5907558467222

## Pasta želova do mycia rąk usuwa trudne zabrudzenia

Gel paste for cleaning hands of persistent dirt / Gel-Handwaschpaste, entfernt hartnäckigen Schmutz / гелевая паста для мытья рук удаляет сильные загрязнения / гелева паста для миття рук видаляє складні забруднення / A zselé formájú kézmosó paszta eltávolítja a makacs szennyeződéseket / Pasta-gel pentru spălarea mâinilor îndepărtează murdăria persistentă / Gelová pasta na mytí rukou odstraňuje odolné nečistoty / Gélková pasta na umývanie rúk odstraňuje silné znečistenie / Gel pasta za umivanje rok odstranjuje trdovratne madeže / Gelinē pasta rankoms plauti pašalina sunkiai įveikiamus nešvarumus / Gēla pasta roku mazgāšanai norēem stiprus netīrumus / Geeljas kätepesupasta eemaldab ka tugeva määrdumise / гел-паста за измиване на ръце за отстраняване на силни замърсявания / Pasta u gelu za pranje ruku, uklanja tvrdokorna zaprljanja / Pasta u gelu za uklanjanje tvrdokornih zaprljanja / πάστα γελ για το πλύσιμο των χεριών αφαιρεί δύσκολή βρωμιά / Pasta gel lavamanos para eliminar la suciedad persistente / Una pasta gel lavamani le sporcie difficili da rimuovere / Pasta de gel para lavar mãos que remove a sujeira difícil / Pâte gel pour le lavage des mains ; élimine les saletés tenaces / De gel pasta voor het wassen van de handen die hardnekkig vuil verwijdert

NEO  
TOOLS

500g



Ref.	Color	☒	EAN
10-401	Orange	1/0	5907558467154
10-403	Yellow	1/0	5907558467178
10-405	White	1/0	5907558467192

NEO  
TOOLS

4.0L



Ref.	Color	☒	EAN
10-402	Orange	1/0	5907558467161
10-404	Yellow	1/0	5907558467185
10-406	White	1/0	5907558467208

## Uniwersalne chusteczki czyszczące do rąk

All-purpose hand wipes / Allzweck-Händereinigungstücher / Универсальные чистящие салфетки для рук / Универсальні серветки для очищення рук / Univerzální kéztisztító törölkendők / Șervețele universale pentru curățarea mâinilor / Univerzální ubrusky na čištění rukou / Univerzálne utierky na čistenie rúk / Univerzalní čistilni robčki za roke / Universalios rankų valymo servetėles / Univeršālas roku tīrīšanas salvetes / Univeršaalsd kätepuhastusrätikud / Универсални кърпички за почистване на ръце / Univerzalne maramice za pranje ruku / Univerzalne maramice za pranje ruku / Μαντήλια καθαρισμού χεριών γενικής χρήσεως / Toallitas lavamanos multiuso / Fazzoletti universali per pulire le mani / Toalhetes universais para limpar mãos / Lingettes nettoyantes universelles pour les mains / Universele reinigungsdoekjes voor de handen

NEO  
TOOLS



Ref.	☒	EAN
10-407	1/0	5907558467215





## Žel BHP do mycia rąk

Hand washing Health and Safety gel / Arbeitssicherheit-gel zum händewaschen / Гель ВНР для мытья рук / Гель для мытья рук ВНР / Žel BHP kézmosó gél / Gel BHP de spălat mâini / Žel BHP na mytí rukou / Gél bozpr na umývanie rúk / Gel vzd za umivanje rok / Sveikatos ir saugos rankų gelis / Roku mazgāšanas gels BHP / Kätepesugeel / Гел збрут за измиване на ръце / Ohs gel za pranje ruku / Τζελ πλυσίμου χεριών / Gel BHP de lavado de manos / Gel per la pulizia delle mani / Gel BHP de lavagem de manos / BHP gel voor het wassen van de handen

NEO  
TOOLS



Ref.	[ml]	☒	EAN
10-410	250	0/60	5907558470413
10-411	500	0/36	5907558470420

## Naczynie pomiarowe z pokrywką

Measurement vessel with cover / Messbecher mit Deckel / Мерный сосуд с крышкой / Мјрна посудина з кришкoу / Mérőedény fedéllel / Vas de măsurare cu capac / Мěřicí nádoba s víkem / Odmerná nádoba s vekom / Merilna posoda s pokrovom / Matavimo indas su dangteliu / Mērišanas trauks ar vāku / Kaanega mõõtenõud / Измервателен съд с капак / Mјerna posuda s poklopcem / Merna posuda sa poklopcem / Δοσομετρική με καπάκι / Recipiente de medición con tapa / Misurino con copercchio / Recipiente de medida com tampa / Réceptien de mesure avec couvercle / Maatbeker met deksel

PRESSOL



Ref.	Info	☒	EAN
07 622	2 l	1/6	4103810076220
07 623	3 l	1/6	4103810076237

## Dozownik do oleju

Liquid measure / Öldosierungseinheit / Стакан измерительный / Дозатор оливиї / Olajadagoló / Dozator de ulei / Dávkováč na olej / Dávkováč oleja / Dozornik za olje / Tepalo dozatorius / Eļļas dozētājs / Öldosator / Маслен дозатор / Dozer za ulje / Dozer za ulje / Μεζούρα λαδιού / Dosificador para aceite / Dosatore per olio / Dispensador de óleo / Doseur d'huile / Doseermaat voor olie

PRESSOL



Ref.	Info	☒	EAN
07 605	5 l	1/6	4103810076053

## Olejarka

Oilier / Ölör / Маслѐнна / Оливница / Olajozó / Gresor de ulei / Maznička / Olejnička / Oljica / Tepalinė / eļļas kanniņa / Ölikann / Маслоњка / kantica za ulje / Kantica za podmazivanje uljem / Δοχείο λιπαντικού / Aceitera / Oliatore / Máquina de pôr óleo / Graisseur à huile / Smeertoestel

NEO  
TOOLS



350  
cm<sup>3</sup>

250 mm

Ref.	L[mm]	☒	EAN
11-512	250	10/100	5907558415377

PRESSOL



Ref.	Info	☒	EAN
05 114	350 ml	1/6	4103810051142
05 115	500 ml	1/6	4103810051159

TOP TOOLS



300  
ml

Ref.	Info	☒	EAN
77P505	130 mm	10/60	5902062151292

## Kanister na wodę

Can for water / Wasserbehälter / Канистра для воды / Kanistera для воду / Vizeskanna / Bidon de apă / Kanistr na vodu / Kanistra na vodu / Kanister za vodu / Bakas vandeniui / Ūdens kanna / Будон за вода / Kanister za vodu / Kanta za vodu / Κάνιστρο νερού / Bidón para agua / Tanica per l'acqua / Tanque para água / Jerrycan à eau / Jerrycan voor water

PRESSOL



Ref.	Info	☒	EAN
21 163	10 l	1/0	4103810211638
21 165	15 l	1/0	4103810211652
21 167	20 l	1/0	4103810211676
21 169	35 l	1/0	4103810211690



## Smarownica na pojemniku

Grease pump with container / Schmiergerät mit Behälter / Маслораздаточная установка / Дозатор оливи на ёмкости / Tartályos zsírzó / Gresorul cu rezervor / Maznice na zásobníku / Maznica na zásobníku / Mazalnik z rezervoarjem / Tepalinė su talpykla / Είλας σαδαλες ιεκάρτα / Ölipüstol koos õlimahutiga / Масльонка с резервоар / Mazalica na sprężniku / Mazalica na kontejneru / Δοσομετρική αντλία παροχής λιπαντικού / Engrasadora con depósito / Pompa manuale per grasso / Lubrificador no recipiente / Graisseur sur récipient / Smeerapparaat op bak

PRESSOL



Ref.	Info	☒	EAN
17 786	8 kg	1/0	4103810177866

## Smarownica nożna

Foot grease pump / Fuß-Schmiergerät / Маслораздаточная установка / Оливорозпилювач ніжний / Lábpédálós zsírzó / Gresor actionat cu piciorul / Nožní maznice / Maznica nożná / Nožní mazalnik / Mobilni teralo talpykla / Είλας σαδαλες ιεκάρτα / Јалг-ölipüstol / Крачна масльонка / Nožna mazalica / Nožna mazalica / Δοσομετρική αντλία παροχής λιπαντικού / Engrasadora de pie / Pompa a pedale per grasso / Lubrificador de comando de pernas / Graisseur à pied / Voetsmeerapparaat

PRESSOL



Ref.	Info	☒	EAN
17 793	15 kg	1/0	4103810177934

## Smarownica pneumatyczna

Pneumatic grease gun / Pneumatisches Schmiergerät / Силидопонагнетатель пневматический / Дозатор оливи пневматичний / Pneumatikus zsírzó / Gresor pneumatic / Pneumatická maznice / Maznica pneumatická / Pnevmatiski mazalnik / Tepalinė pneumatinė / Pneumatiska solidola spiede / Pnevmaatiline ölipüstol / Масльонка пневматична / Pnevmatiska mazalica / Pnevmatiska mazalica / Γρασαδόρος αέρος / Engrasadora neumática / Ingrassatore pneumatico / Lubrificador neumático / Graisseur pneumatique / Pneumatisch smeerapparaat

PRESSOL



Ref.	Info	☒	EAN
18 071	500 cm <sup>3</sup> + 12 635 +12 631	1/0	4103810180712

## Pompa ręczna do oleju

Hand pump for oil / Handölpumpe / Ручной насос для масла / Pompa ręczna do oliwi / Kézí olajpumpa / Pompa manuală, pentru ulei / Ruční pumpa na olej / Ručné čerpadlo na olej / Ročna črpalka za olje / Rankine alyvos pompa / Manuālais eļļas sūkņis / Käsi-ölipumppu / Ръчна маслена помпа / Ručna pumpa za ulje / Ručna pumpa za ulje / Χειροκίνητη αντλία λαδιού / Bomba manual para aceite / Pompa dell'olio manuale / Bomba de óleo manual / Pompe à main à huile / Handpomp voor olie

PRESSOL



Ref.	Info	☒	EAN
13 012	18 l / min.	1/0	4103810130120
13 020	7 l / min.	1/0	4103810130205
13 055	15 l / min.	1/0	4103810130557



## Zlewarka oleju

Oil drain tank / Ölabgänger / Сливная воронка для масла / Обладнання для зливання оливи / Olajleeresztó tartály / Cuvetă de scurgere uleiului / Slévačka oleje / Nádrž na zachytávanie oleja / Zbiralnik olja / Tepalo išleidiklis / Eļļas piltuve / Öllehtrite komplekt / Машина за изливане на масло / Aparat za skupljanje ulja / Odlivak za ulje / Χαυτή λαδιού / Dispositivo de drenaje de aceite / Recuperatore olio / Máquina de remoção de óleo / Cuve à récupérer l'huile / Verbindungsstük

PRESSOL



Ref.	Info	☒	EAN
27 030	70 l	1/0	5902062153326
27 070	70 l	1/0	5902062153333

## Odsysarka oleju

Oil suction machine / Ölabsauger / Отсосное устройство для масла / Оливодісмоктувач / Olajleszívó / Aspirator de ulei / Odsávačka oleje / Odsávačka oleja / Aspirator za olje / Alyvos siurbtukas / Eļļas atsūcējs / Öliimur / Вакууман пома за масло / Skupljač ulja / Usisivač za ulje / Αναρροφητήρας λαδιού / Dispositivo de extracción de aceite / Aspiratore olio / Máquina de remover óleo / Vidangeur d'huile / Oliefzuiger

PRESSOL



Ref.	Info	☒	EAN
27 622	70 l	1/0	5902062153340
27 632	70 l	1/0	5902062153357

## Zestw pneumatyczny do smaru

Air operated grease kit / Ölset pneumatisch / Пневматический набор для смазывающего вещества / Комплект пневматичний до мастила / Pneumatikus felszerelés kenőzsírokhoz / Set pneumatic pentru unsoare consistentă / Pneumatică sada pro mazivo / Pneumatická súprava na mazanie / Pnevmatiski komplet za mazivo / Pneumatinis komplektas, tepalui / Smērvielas pneimatiskais komplekts / Pneumaattiline määrdekomplekt / Пневматичен смазочен комплект / Pnevmatiski pribor za mazivo / Пневматіко оет για λιπαντικό / Juego de herramientas neumáticas para engrase / Completo pneumático per il grasso / Kit pneumático p. lubrificação / Jeu d'accessoires pneumatiques à graisse / Lasapparaat

PRESSOL

PRESSOL



Ref.	Info	☒	EAN
18 417 051	50:1, 20 kg	1/0	5902062154026
18 766 950	50:1, 50 kg	1/0	5902062154040



Ref.	Info	☒	EAN
27 846	50:1, 50/60 kg	1/0	5902062154026
27 846-950	50:1, 20 kg	1/0	5902062154040





**ПНЕУМАТУКА**  
PNEUMATICS ПНЕВМАТИКА

## Klucz pneumatyczny udarowy

Pneumatic impact wrench / Pressluftschlagschlüssel / Ключ пневматический ударный / Ключ пневматичний ударний / Pneumatikus ütvecsavarozó / cheie pneumatică de lovit / Pneumatický nárazový klíč / Pneumatická rázová utáhovačka / Pnevmatiski udarni vijac / Pneumatinis, smūginis veržliaraktis / Pnevmatiskā sliena pistole / Pnevmaatiline löök-mutrivõti / Γαϊκούεργμ pneυματικηεν / Pneumatiski Ključ udarni / Pnevmatiski ključ / Σφυρί αέρος αναστρεφόμενο / Llave de impacto neumática / Chiave pneumatica a percussione / Chave pneumática de impacto / Clef pneumatique à chocs / Pneumatisch slagsteutel

**NEO**  
TOOLS



Ref. EAN  
14-002 1/6 5907558442533

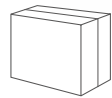

**NEO**  
TOOLS



Ref. EAN  
14-008 1/4 5907558442564

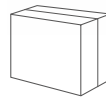

**NEO**  
TOOLS



Ref. EAN  
14-006 1/6 5907558442557

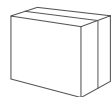

**NEO**  
TOOLS



Ref. EAN  
14-004 1/6 5907558442540

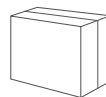

**NEO**  
TOOLS



Ref. EAN  
14-500 1/10 5907558442557

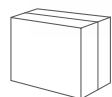

**NEO**  
TOOLS



Ref. EAN  
14-502 1/5 5907558444841

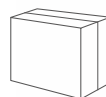

## Klucz pneumatyczny udarowy

Pneumatic impact wrench / Pressluftschlagschlüssel / Ключ пневматический ударный / Ключ пневматичний ударний / Pneumatikus ütvecsavarozó / cheie pneumatică de lovit / Pneumatiký nárazový klíč / Pneumatická rázová uťahovačka / Pnevmatiski udarni vijaz / Pneumatinis, smūginis veržiaraktis / Pneimatiskā sitiēna pistole / Pnevmaatiline löök-mutrivõti / Гаўноверт пневматычн / Pnevmatiski Ključ udarni / Pnevmatiski ključ / Σφύρι αέρος αναστρεφόμενο / Llave de impacto neumática / Chiave pneumatica a percussione / Chave pneumática de impacto / Clef pneumatique à chocs / Pneumatisch slagsleutel

NEO  
TOOLS

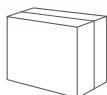

Ref. 14-010 EAN 5907558442571

## Klucz udarowy kątowy

Angle impact driver / Winkel-Schlag-Schlüssel / Ударный ключ / Ударний куттовий ключ / Ütvecsavarozó sarokkulcs / Cheie de impact unghiulara / Rázový rohový klíč / Uhlavý rázový klíč / Kotni udarni ključ / Kampinis smūginis veržiasukis / Leņķveida triecienuzgriežņu atslēga / Nurga-löökvõti / Ёглов ударен ключ / Udarni kutni ključ / Ugaoni udarni ključ / Αεροκλειδί κρούσης / Llave de impacto angular / Chiave a percussione angolare / Chave de impacto angular / Clé à choc angulaire / Haakse slagmoersleutel

NEO  
TOOLS

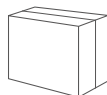

Ref. 14-019 EAN 5907558469011

## Szlifierka prosta pneumatyczna

Pneumatic straight grinder / Schleifmaschine gerade pneumatisch / Прямой пневматический шлифовальный аппарат / Шліфмашина пряма пневматична / Pneumatikus egyenes csiszológép / Polizor simplu, pneumatic / Přímá pneumatická bruska / Pneumatická jednoduchá bruska / Pnevmatiski premi brusilnik / Pneumatinis, tiesinis šlifjuoklis / Pnevmatiska taisna slīpmašīna / Pnevmaatiline lihtihviija / Обикновен пневматычн шлайф / Pnevmatiska jednostavna brusilica / Pnevmatiska prosta obična brusilica / Ευθύς λειαντήρας αέρος / Amoladora neumática recta / Smerigliatrice pneumatica dritta / Disco de limar reto neumático / Meuleuse droite pneumatique / Pneumatische rechte schuurmachine

NEO  
TOOLS

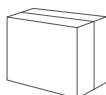

Ref. 14-014 EAN 5907558442595

## Klucz kątowy pneumatyczny

Pneumatic angle wrench / Winkelschlüssel pneumatisch / Ключ угловой пневматический / Мутровверт куттовий пневматичний / Pneumatikus racsnis kulcs / Cheie unghiulară, pneumatică / Uhlavý klíč pneumatiký / Pneumatiký uhlavý klíč / Pnevmatiska raglja / Pneumatinis kampinis raktas / Pnevmatiskā leņķu atslēga / Pnevmaatiline nurkvõti / Ёглов пневматычн ключ / Pnevmatiski kutni ključ / Pnevmatiski ugaoni ključ / Κλειδί γωνιακό αέρος / Llave articulada neumática / Chiave pneumatica angolare / Chave de canto pneumática / Clef d'angle pneumatique / Pneumatisch haaksleutel

NEO  
TOOLS

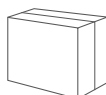

Ref. 14-012 EAN 5907558442588

## Szlifierka pneumatyczna kąтова

Pneumatic angle grinder / Pressluftwinkelschleifer / Машина шлифовальная угловая пневматическая / Шліфмашина пневматична наріжна / Pneumatikus csiszoló / Mašīnā pneumaticā de šļeifut sub unghi / Pneumatická bruska úhlová / Brúska pneu. uhlavá / Kotni pnevmatski brusilnik / Pneumatinis kampinis šlifjuoklis / Pnevmatiskā leņķa slīpmašīna / Pnevmaatiline nurklīhvīmīmasin / Ёглошлайф пневматычн / Pnevmatiska kutna brusilica / Pnevmatiska brusilica / Γωνιακός τροχός αέρος / Amoladora neumática angular / Retifcitrice pneumatica angolare / Disco de limar p. cantos pneumático / Meuleuse pneumatique d'angle / Pneumatische versteckschuurmachine

NEO  
TOOLS

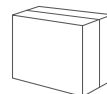

Ref. 14-016 EAN 5907558442601

## Szlifierka oscylacyjna pneumatyczna

Pneumatic finishing sander / Vibrationsschleifer pneumatisch / Колебательный пневматический шлифовальный аппарат / Шліфмашина осциляційна пневматична / Pneumatikus vibrációs csiszoló / Polizor oscilatoriu, pneumatic / Oscilační pneumatická bruska / Pneumatická vabračná bruska / Pnevmatiski vibrācijaski brusilnik / Vibracinis, pneumatinis šlifjuoklis / Pnevmatiska oscilācijas slīpmašīna / Pnevmaatiline taldlhviija / Осциляторн пневматычн шлайф / Pnevmatiska vibrācijaska brusilica / Pnevmatiska oscilatorna brusilica / Παλμικό τριβείο αέρος / Lijadora neumática orbital / Levigatrice a delta pneumatica / Disco de limar oscilante pneumático / Meuleuse oscillatoire pneumatique / Pneumatische oscillatie schuurmachine /

NEO  
TOOLS

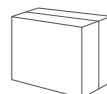

Ref. 14-018 EAN 5907558442618



## Szlifierka pneumatyczna kątowa

Pneumatic angle grinder / Pressluftwinkelschleifer / Машина шлифовальная угловая пневматическая / Шліфмашинка пневматична нарізна / Pneumatikus csiszoló / Maşină pneumatică de şlefuit sub unghi / Pneumatická bruska úhlová / Brúška pneu. uhlová / Kotni pnevmatski brusilnik / Pneumatinis kampinis šlifuoklis / Pnevmatiskā leņķa slīpmašīna / Pnevmaatiline nurklühvimmasin / Βελουλαούφ πνευματική / Pneumatska kutna brusilica / Pneumatska brusilica / Γωνιακός τροχός αέρος / Amoladora neumática angular / Retificatrice pneumatica angolare / Disco de limar p. cantos pneumático / Meuleuse pneumatique d'angle / Pneumatische versteckschuermachine

**NEO**  
TOOLS

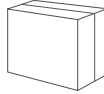

Ref. 14-508 1/10 EAN 5907558444858

## Wiertarka pneumatyczna

Pneumatic drill / Bohrmaschine pneumatisch / Дрель пневматическая / Дриль пневматичний / Pnevmatikus fúrógép / Masina de gaurit pneumatica / Pneumatická vrtačka / Pnevmatická vrtačka / Pnevmatiski vrtalnik / Pneumatinis gręžuvas / Pneumatiska urbjmašīna / Pnevmaatiline trell / Пневматична пробивна машина / Pneumatska bušilica / Pneumatska bušilica / Δράπανο αέρος / Taladradora neumática / Trapano pneumatico / Berbequim pneumático / Erçeuse pneumatique / Pneumatische boormachine

**NEO**  
TOOLS

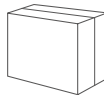

Ref. 14-026 1/10 EAN 5907558442632

**NEO**  
TOOLS

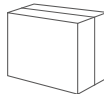

Ref. 14-514 1/10 EAN 5907558444865

## Szlifierka mimośrodowa pneumatyczna

Pneumatic orbital sander / Excenterschleifer pneumatisch / Машина шлифовальная эксцентриковая пневматическая / Шліфмашинка ексцентрикова пневматична / Pnevmatikus excentercsiszoló / Polizor excentric, pneumatic / Pneumatická excentrická bruska / Pneumatická excentrická bruska / Pnevmatiski ekscentrični brusilnik / Pneumatinis, ekscentrinis šlifuoklis / Pnevmatiska ekscentrika slīpmašīna / Pnevmaatiline ekscentriklihvija / Пневматичен ексцентършлайф / Pneumatska ekscentarska brusilica / Pneumatska ekscentrična brusilica / Εκκεντρο τρίβείο αέρος / Lijadora neumática excéntrica / Levigatrice rotoorbitale pneumatica / Disco de limar para excéntrico pneumático / Meuleuse excentrique pneumatique / Pneumatische excenter schuurmachine

**NEO**  
TOOLS

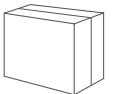
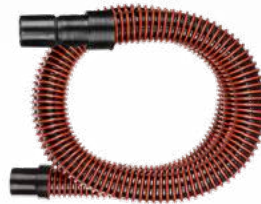

Ref. 14-013 0/10 EAN 5907558469028

**NEO**  
TOOLS

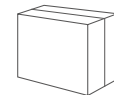

Ref. 14-020 1/12 EAN 5907558442625

**NEO**  
TOOLS

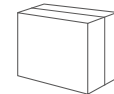

Ref. 14-510 1/10 EAN 5907558446357



## Pneumatyczny młotek igłowy czołowy

Pneumatic butt-face needle hammer / Pneumatischer Front-Nadelhammer / Пневматический изолячатый зачистной молоток / Γολκνοεῦ πνευματικὴν πορτσεῦν μολοτοκ / Pneumatikus homlok tűkalapács / Ciocan cu ace pneumatic frontal / Čelní pneumatické jehlové kladivo / Čelové pneumatické ihlicové kladivo / Pnevmatsko koničasto kladivo / Pneumatinis adatinis plaktukas / Pneimatiskais priekšējais adatu āmurs / Pneumaatile ots-nõelhaamer / Пневматичен челен иелен чуκ / Pneumatski iglasti čeoní čekić / Čeoní pneumatski iglasti čekić / Μηροσπινὸ πνευματικὸ σφύρι βελόνας / Martillo neumático de aguja frontal / Martello pneumatico ad aghi / Martelo de agulha frontal pneumático / Marteau pneumatique à aiguilles frontal / Pneumatische naaldbikhamer

NEO TOOLS



Ref. 14-031 EAN 5907558468977

NEO TOOLS



Ref. 14-032 EAN 5907558468984

## Młotek udarowy pneumatyczny

Pneumatic impact hammer / Schlaghammer pneumatisch / Молоток ударный пневматический / Перфоратор пневматический / Pneumatikus véskalapács / Ciocan cu percucie pneumatică / Pneumatické rázové kladívko / Pneumatické príklepové kladívko / Pnevmatsko udarno kladivo / Pneumatinis atskelimo plaktukas / Pneimatiskais sitamais āmurs / Pneumaatileine löökvasar / Пневматичен ударен чуκ / Pneumatski udarni čekić / Udarni pneumatski čekić / Κροστικὴ σφύρα αέρος / Martillo neumático de impacto / Martello pneumatico / Martelo de impacto pneumático / Martelet à chocs pneumatique / Pneumatische slaghamer

NEO TOOLS



Ref. 14-028 EAN 5907558442649

## Przecinarka pneumatyczna

Air Cut-Off Tool / Pneumatisches Schneidegerät / Пневматический резак / Пневматичний різальний станок / Pneumatikus vágó / Mašina de tăiat pneumatică / Pneumatická řezačka / Pneumatická pila / Pnevmatski rezalnik / Pneumatinis pjūvklis / Pneimatiskais griezējs / Pneumaatileine lõikur / Пневматичен фреза / Pneumatski rezač / Pnevmatska seckalica / Εργαλείο διακοπής αέρα / Cortador neumático / Troncatrice pneumatică / Cortador pneumático / Dispositif de coupe pneumatique / Pneumatische doorslijpmachine

NEO TOOLS



Ref. 14-017 EAN 5907558468991

## Piła pneumatyczna

Air Body Saw / Luftkörper säge / Воздушная пила / Пневматична пила для мина / Pneumatikus fűrés a testhez / Ferăstrău pneumatic pentru caroserie / Pneumatická pila / Pneumatická pila / Pnevmatska žaga / Pneumatinis pjūklas / Pneimatiskais zāģis / Pneumaatileine saag / Pnevmatska pila / Пневматска местера / Αερόπρινο / Sierra neumática / Segă pneumatică / Serra pneumática / Scie pneumatique / Pneumatische zaag

NEO TOOLS



Ref. 14-034 EAN 5907558469004

## Dłuta komplet

Chisel set / Beitelsetz / Набор долот / Зубила та пробивачи / Vésőkészlet / Set dălți / Sada dlát / Súprava dlát / Garnitura dlet / Kaltu komplektas / Kaltu komplekts / Peilite komplekt / Σεκασι υ πιλο / Špica / Sekac / Συλλογή από σμίλες / Juego de formones / Set di scalpelli / Conjunto de Raspadores / Jeu de ciseaux

NEO TOOLS



Ref. 14-029 EAN 5907558455298

## Sprężyny

Springs / Federn / Пружини / Пружини / Rugó készlet / Arcuri / Pružiny / Pružiny / Vzmeti / Spyruokliji rinkiny / Atsperes / Vedrud / Пружини / Opruge / Opruge / Σετ ελατήρια / Espirales / Molle / Molas / Ressorts / Veren

NEO TOOLS



Ref. 14-030 EAN 5907558455304





## Zszywacz pneumatyczny

Pneumatic stapler / Pneumatische Heftmaschine / Степлер пневматический / Степлер пневматичний / Pneumatikus tűzőgép / Capsator pneumatic / Pneumatická sešivačka / Pneumatická zošivačka / Pnevmatski spenjač / Pneumatinis kablių pistoletas / Pneimatiskais skavotājs / Pneumatiline klambripūstol / Пневматичен мелбод / Pneumatska klamera / Pneumatska heftalica / Συρραπτικό αέρα / Grapadora neumática / Graffettatrice pneumatica / Máquina de pontear pneumática / Agrafeuse pneumatique / Pneumatische hechtmaschine

**NEO**  
TOOLS

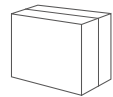
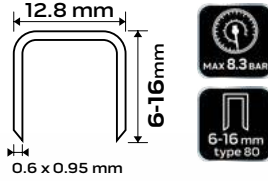

Ref.	☒	EAN
14-572	0/10	5907558444889

**NEO**  
TOOLS

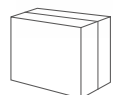
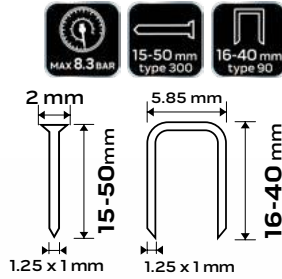

Ref.	☒	EAN
14-570	0/10	5907558444872

## Zszywki

Staples / Klammern / Скобы / Скобу / Tűzőkarocs / Capsator / Sešivací spony / Sponky / Sponke / Kabés / Skavas / Klambriid / Телчета / Municija za klameraicu / Heftalica / Συρραπτικό / Grapas / Punti metallici / Pontas / Agrafes / Hechters

**NEO**  
TOOLS

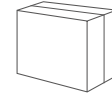
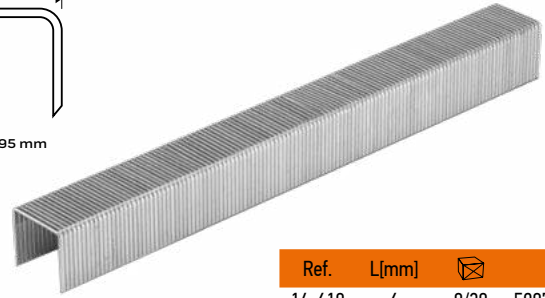
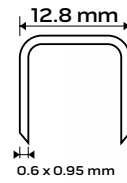

Ref.	L[mm]	☒	EAN
14-610	6	0/30	5907558453720
14-611	8	0/30	5907558453737
14-612	10	0/30	5907558453744
14-613	12	0/30	5907558453751
14-614	14	0/30	5907558453768
14-615	16	0/30	5907558453775

**NEO**  
TOOLS

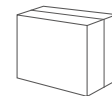
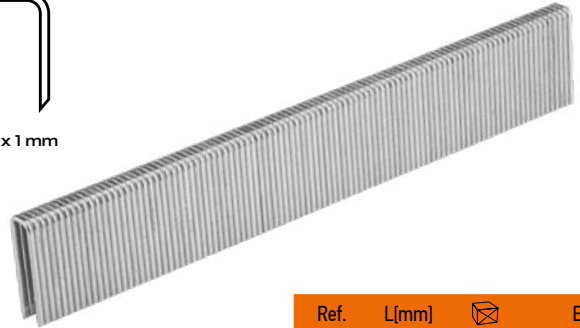
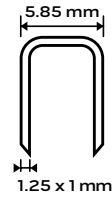

Ref.	L[mm]	☒	EAN
14-620	10	0/16	5907558453782
14-621	12	0/16	5907558453799
14-622	15	0/16	5907558453805
14-623	20	0/12	5907558453812
14-624	22	0/12	5907558453829
14-625	25	0/12	5907558453836
14-626	28	0/12	5907558453843
14-627	30	0/12	5907558453850
14-628	32	0/8	5907558453867
14-629	35	0/8	5907558453874
14-630	38	0/6	5907558453881
14-631	40	0/6	5907558453898

## Gwoździe

Nails / Nägel / Гвозди / Цвяхи / Tűzőszeg / Cuie / Hřebíky / Klince / Žebliji / Vyns / Naglas / Naelad / Пирони за такеп / Čavlići za pnevmatsku klameraicu / Municija za heftalica / Καρφιά / Clavos / Chiodi / Pontas / Agrafes / Spijkers

**NEO**  
TOOLS

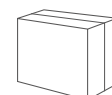
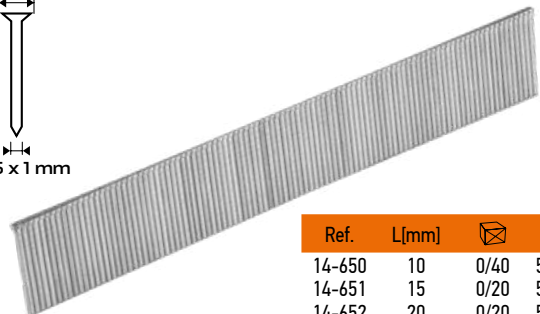
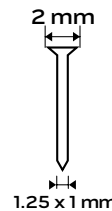

Ref.	L[mm]	☒	EAN
14-650	10	0/40	5907558453904
14-651	15	0/20	5907558453911
14-652	20	0/20	5907558453928
14-653	25	0/20	5907558453935
14-654	30	0/20	5907558453942
14-655	35	0/12	5907558453959
14-656	40	0/12	5907558453966
14-657	45	0/12	5907558453973
14-658	50	0/12	5907558453980



## Nasadka udarowa

Impact socket / Schlagaufsatz / Насадка ударная / Патрон перфораторный / Gépi dugókulcs / Brūtarā cu percute / Příkladový nástavec / Prikleповý nástavec / Udarni nasadni ključ / Antgalis kalimui / Triecienuzgalis / Lööksak / Ударна наставка / Udarni nasadni nastavak / Ударна кариса / Упобохј крисуакоу анталаккоу / Llave de vaso para atornilladores de impacto / Bussola esagonale / Bocal de impacto / Douille à choc / Slagdoop

**NEO**  
TOOLS

CrMo  
steel

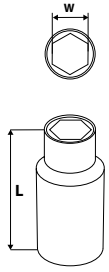

Ref.	W[mm]	L[mm]	☒	EAN
12-210	10	38	20/200	5907558423808
12-212	12	38	20/200	5907558423822
12-213	13	38	20/200	5907558423839
12-214	14	38	20/200	5907558423846
12-215	15	38	20/200	5907558423853
12-216	16	38	20/200	5907558423860
12-217	17	38	20/200	5907558423877
12-219	19	38	20/200	5907558423884
12-221	21	38	20/200	5907558423891
12-222	22	38	20/200	5907558423907
12-224	24	38	20/200	5907558423914

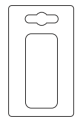

**NEO**  
TOOLS

CrMo  
steel

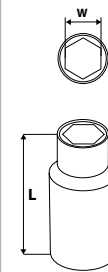

Ref.	W[mm]	L[mm]	☒	EAN
12-310	10	78	10/100	5907558423921
12-312	12	78	10/100	5907558423945
12-313	13	78	10/100	5907558423952
12-314	14	78	10/100	5907558423969
12-315	15	78	10/100	5907558423976
12-316	16	78	10/100	5907558423983
12-317	17	78	10/100	5907558423990
12-319	19	78	10/50	5907558424003
12-321	21	78	10/50	5907558424010
12-322	22	78	10/50	5907558424027
12-324	24	78	10/50	5907558424034

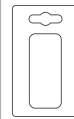

**NEO**  
TOOLS

CrV  
steel 1/2" x10

1/2" - 10, 12, 13, 14, 16, 17, 19, 21, 22, 24 mm

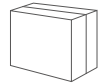

Ref.	☒	EAN
12-101	0/20	5907558414509

**NEO**  
TOOLS

CrMo  
steel 1" x9

1" - 27, 30, 32, 35, 36, 38, 41, 42, 50 mm



Ref.	☒	EAN
12-105	0/2	5907558414530

**NEO**  
TOOLS

CrV  
steel 1/2" x11

1/2" - 10, 11, 12, 13, 14, 16, 17, 19, 21, 22, 24 mm

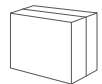

Ref.	☒	EAN
12-102	0/10	5907558414516

**NEO**  
TOOLS

CrMo  
steel 1/2" x9

E10, E11, E12, E14, E16, E18, E20, E22, E24



Ref.	☒	EAN
12-110	0/20	5907558414554

**NEO**  
TOOLS

CrMo  
steel 1/2" x10

1/2" - 10, 12, 13, 14, 15, 17, 19, 21, 22, 24 mm

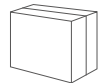

Ref.	☒	EAN
12-107	0/10	5907558414547

**NEO**  
TOOLS

CrMo  
steel



**NEO**  
TOOLS

CrMo  
steel 3/4" x8

3/4" - 126, 27, 29, 30, 32, 35, 36, 38 mm

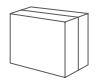

Ref.	☒	EAN
12-115	0/6	5907558414523

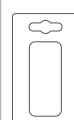

Ref.	☒	EAN	
10-258	T30	1/10	5907558469660
10-259	T40	1/10	5907558469677
10-260	T45	1/10	5907558469684
10-261	T50	1/10	5907558469691
10-262	T55	1/10	5907558469707
10-263	T60	1/10	5907558469714
10-264	T70	1/10	5907558469721
10-265	T80	1/10	5907558469738



## Klucze udarowe torx

Impact Torx bit socket set / Torx-Schlagschrauber-Satz / "Набор ударных торцевых ключей Torx" / Набор ключей ударных «Torx» / Torx gépi kulcsok / Chei cu impact torx / Nástrčné kľúče torx / Rázové kľúče torx / Udarni nasadni ključići Torx / Smūginiai raktai „TORX“ / Triecienatlēgas torx / Torx-löökvõtmed / Ударни ключеве torx / udarni ključevići torx / Udarni ključevići torx / Σετ κρουστικά μπουλονόκλειδα Torx / Llaves de impacto torx / Inserti Torx / Jogo de chaves de percussão torx / Clés à choc torx / Torx slagsleutels

**NEO**  
TOOLS

★ T25, T27, T30, T40, T45, T50, T55, T60



Ref.	☒	EAN
08-712	0/20	5907558418620

**NEO**  
TOOLS

★ T30, T40, T45, T50, T55, T60, T70, T80



Ref.	☒	EAN
10-257	1/10	5907558469653

## Przedłużka udarowa

Impact extension / Wirkungsverlängerung / Ударный удлинитель / Ударный Подовжувач / Toldósár / Prelungitor / Prodlužovák / Predĺženie / Podaljšek / Ilgiklis / Pagarinātājs / Pikendus / Удължител / Produženi poluga / Produzena poluga / Προέκταση / Alargadera / Prolunga / Extensão / Prolongation / Verlengstuk

**NEO**  
TOOLS

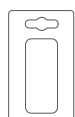

Ref.	L[mm]	☒	EAN
10-250	50	1/10	5907558469585
10-251	75	1/20	5907558469592
10-252	125	1/10	5907558469608

## Przegub udarowy

Impact joint / Schlaggelenk / Ударный шарнир / Ударний шарнір / Csukló / Articulație de impact / Nárazový kľoub / Nárazový čap / Udarνια zglob / Lankstas / Šarnīrs / Klamber / Шарнир / Zglob / Zglob / Μεντεσές / Articulación / Snodo / Articulação / Articulation / Spilverbinding

**NEO**  
TOOLS

**CrMo**  
steel

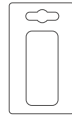

Ref.	Info	☒	EAN
10-253	1/4"	1/20	5907558469615
10-254	3/8"	1/20	5907558469622
10-255	1/2"	1/10	5907558469639

**NEO**  
TOOLS

**x3**  
**CrMo**  
steel

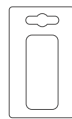

Ref.	☒	EAN
10-256	1/10	5907558469646

## Zestaw do uzdatniania powietrza

Air treatment kit / Luftaufbereitungssset / Набор для очистки воздуха / Комплект до підготовки повітря / Levegőelőkészítő egység / Garnitură de imobilarea aerului / Sada pro úpravu vzduchu / Súprava na upravnovanie vzduchu / Komplet za obdelavo zraka / Suslęgto oro apdorojimo įrenginys / Gaisa attīršanas komplekts / Ūhupuhaustskomplekt / Комплект за подготовка на въздуха / Set za pripremu zraka / Pribor za tretiranje vazduh / Σετ καθαρισμού αέρος / Dispositivo de procesamiento del aire / Filtro, riduttore, lubrificatore / Kit para purificar ar / Jeu pour traitement d'air / Set van mondstukken voor zandblazen

**NEO**  
TOOLS



**1/2"**  
**0-12 bar**  
**20µm**  
**CE**

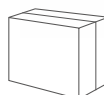

Ref.	☒	EAN
14-734	1/25	5907558452235



## Filtr odwadniacz

Draining filter / Entwässerungsfilter / Фильтр / Фильтр сепараторный / Víztelenítő szűrő, fémházas / Filtru - dezodorizant / Odvodňovací filtr / Odvodňovací filter / Odvodni filter / Filtras- džiovintuvás / Atūdeņošanas filtrs / Veefilter / Фильтр за отводняване / Filtrar za upijanje vode / Odvodni filter / Φίλτρο-διαχωριστής / Filtra de drenaje / Filtra di drenaggio / Filtra / Filtre purgeur / Filter drainage

NEO  
TOOLS



1/2"

0-9 bar



Ref.	⊠	EAN
14-732	1/50	5907558452228

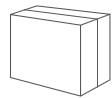

NEO  
TOOLS



1/2"

0-9 bar



Ref.	⊠	EAN
14-730	1/25	5907558452211

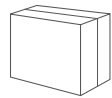

NEO  
TOOLS



1/4"

Ref.	⊠	EAN
14-550	1/125	590755844896

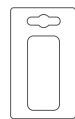

## Zestaw nasadek

Socket set / Aufsatzset / Набор головок торцевых / Набор насадок торцевых / Dugókulcs készlet alufelnihez, vékonyfalú / Set duze / Sada násadek / Súprava nástr. klúčov / Garnitura nasadnih ključev / Antgalių rinkinys / Mucipų kompleks / Padrunikomplekt / Гедоре компл / Šesterokutne kapice / Gedora set / Συλλογή καρδακιών / Llaves de vaso / Set di boccole / Kit de bicos / Jeu de douilles / Set van doppen

NEO  
TOOLS

1/2" - 17, 19, 21 mm



CrMo  
steel

Alu

1/2"

Ref.	⊠	EAN
12-350	0/20	5907558435849

## Przewód ciśnieniowy spiralny

High pressure spiral hose / Spiraldruckleitung / Шланг сжатого воздуха спиральный / Шланг високого тиску / Pneumatikus spiráltömlő / Furtun spiral presiune înaltă / Tlakové potrubí spirálové / Vysokotlaká spirálová hadica / Visokotlačna spiralna gibka cev / Spiralinė aukšto slėgio žarna / Spirálveida gaisa caurulvads / Kõrgsurveoolik (spiraal) / Маркуч за компресор / Spiravno crijevo najlonsko / Crevo za visoki pritisak / Σπρωοειδής ρύγχος υψηλής πίεσης / Tubo de presión / Tubo a spirale in nylon / Cabo de tensão espiral / Durite de pression hélicoïdale / Spiraal drukleiding

NEO  
TOOLS

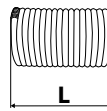

PU

MAX  
8BAR

+35°C  
-10°C

Ref.	L [m]	⊘ [mm]	▷◁ [mm]	⊠	EAN
12-070	5	6,5	10,0	0/50	5907558414448
12-071	10	6,5	10,0	0/20	5907558414455
12-072	15	6,5	10,0	0/20	5907558414462
12-074	5	8,0	12,0	0/25	5907558414479
12-075	10	8,0	12,0	0/20	5907558414486
12-076	15	8,0	12,0	0/15	5907558414493

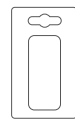

NEO  
TOOLS

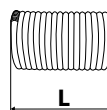

15  
m

PU

MAX  
8BAR

Ref.	L [m]	⊘ [mm]	▷◁ [mm]	⊠	EAN
14-800	15	10,0	15,0	0/10	5907558444667
14-802	15	12,0	17,0	0/10	5907558444674

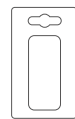

NEO  
TOOLS

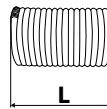

PP

8mm

5mm

MAX  
8BAR

Ref.	L [m]	⊘ [mm]	▷◁ [mm]	⊠	EAN
14-808	5	5,0	8,0	0/50	5907558457865
14-804	10	5,0	8,0	0/25	5907558444681
14-806	15	5,0	8,0	0/25	5907558444698

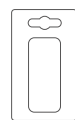

## Przewód ciśnieniowy zbrojony

High pressure reinforced hose / Druckleitung verstärkt / Шланг високого давления армированный / Шланг високого тиску, армований / Pneumatikus tömlő / Furtun armat presiune înaltă / Tlakové potrubí vyztužené / Vysokotlaká hadica / Visokotlačna gibka cev / Sustiprinta aukšto slėgio žarna / Augstspiediena gaisa caurulvads / Tugevadut kõrgsurveoolik / Маркуч за вис. налягане / crijevo za visoki pritisak / Crevo za visoki pritisak / Ενισχυμένος ρύγχος υψηλής πίεσης / Tubo de presión reforzado / Tubo a pressione rinforzato / Cabo de tensão armado / Durite de pression armée

NEO  
TOOLS



PVC

+40°C  
-10°C

Ref.	L [m]	⊘ [mm]	▷◁ [mm]	P <sub>max</sub> [bar]	⊠	EAN
12-079	50	8,0	13,0	19	0/1	5907558414936
12-080	50	10,0	15,0	17	0/1	5907558414943
12-081	50	12,0	17,0	13	0/1	5907558414950



## Szybkozłączka

Quick coupler / Schnellkupplungen / Быстросменная муфта / Муфта швидкорознімна / Pneumatikus gyorscsatlakozó / Conector rapid / Rychlospojka / Rýchlospojka / Hitra spojka / Greitoji jungtis / Ātrsavienotājs / Kiirühendus / Бърза връзка / Spojnica / Brzo odvajanje / Συζευκτήρας ταχείας απελευθέρωσης / Acoplador rápido / Connettore rapido con presa per tubo / União rápida / Rapport rapide / Snelkoppeling

NEO  
TOOLS

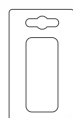

Ref.	⌀ [mm]	▶ [mm]	⊠	EAN
12-600	4	6	0/36	5907558417685
12-601	6	8	0/27	5907558417692
12-602	8	10	0/27	5907558417708

NEO  
TOOLS

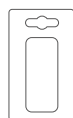

Ref.	▶ [mm]	⊠	EAN
12-620	7	0/36	5907558417814
12-621	8	0/36	5907558417821
12-622	10	0/36	5907558417838
12-623	12	0/36	5907558417845

NEO  
TOOLS

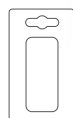

Ref.	▶ [mm]	⊠	EAN
12-630	7	0/36	5907558417890
12-631	8	0/36	5907558417906
12-632	10	0/36	5907558417913

NEO  
TOOLS

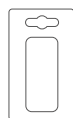

Ref.	⊠ ["]	⊠	EAN
12-635	1/4	0/36	5907558417920
12-636	3/8	0/36	5907558417937
12-637	1/2	0/36	5907558417944

NEO  
TOOLS

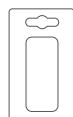

Ref.	⊠ ["]	⊠	EAN
12-645	1/4	0/36	5907558417975
12-646	3/8	0/36	5907558417982

NEO  
TOOLS

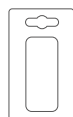

Ref.	⊠ ["]	⊠	EAN
12-650	1/4	0/36	5907558417999
12-651	3/8	0/36	5907558418002

## Złącze do węży

Hose connection / Schlauchverbinder / Соединители для шланга / Армура до шлангу / Pneumatikus tömlőtoldaló / Imbinare de furtun / Spojka pro hadici / Spoj na hadicu / Konektor za cev / Jungtis žarnai / Šļūtenes savienotāji / Voolikiühendus / Съединение за шланга / Spojna za cijev / Spoj za crevo / Σύνδεσμοι εύκαμπτου σωλήνα / Junta para manguera / Connettore per tubo / União p. Mangueira / Raccord pour flexible / Verbindingsstuk voor slang

NEO  
TOOLS

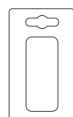

Ref.	▶ [mm]	⊠	EAN
12-610	6	0/36	5907558417739
12-611	8	0/36	5907558417746
12-612	10	0/36	5907558417753
12-613	12	0/36	5907558417760

NEO  
TOOLS

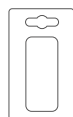

Ref.	▶ [mm]	⊠ ["]	⊠	EAN
12-615	6	1/4	0/36	5907558417777
12-616	10	1/4	0/36	5907558417784
12-617	10	1/2	0/36	5907558417791
12-618	12	1/2	0/36	5907558417807

## Końcówka do szybkozłączki

Quick coupler tip / Endstück für Schnellkupplung / Наконечник быстрого соединения / Насадка для швидко рознімної муфти / Pneumatikus csatlakozó külsőmenet- gyorsvég / Piesă de conectare rapidă / Koncovka pro rychlospojku / Nástavec rýchlospojka / Nastavek za hitro spojko / Greitai gais jungtis antgalis / Ātrsavienojuma uzgalis / Kiirühendusotsak / Накрайник за бърза връзка / nastavak za spojnicu / Kraj za brzo priključivanje / Κεφαλή ταχείας σύνδεσης / Voquilla para acoplador rápido / Connettore rapido con presa per tubo / Ponteiro do uniões rápidas / Embout pour raccord rapide / Eindstuk voor snelkoppeling

NEO  
TOOLS

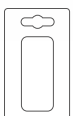

Ref.	⌀ [mm]	▶ [mm]	⊠	EAN
12-605	6	8	0/27	5907558417715
12-606	8	10	0/36	5907558417722

NEO  
TOOLS

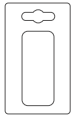

Ref.	⊠ ["]	⊠	EAN
12-640	1/4	0/30	5907558417951
12-641	3/8	0/36	5907558417968

NEO  
TOOLS

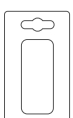

Ref.	▶ [mm]	⊠	EAN
12-625	7	0/36	5907558417852
12-626	8	0/36	5907558417869
12-627	10	0/36	5907558417876
12-628	12	0/36	5907558417883

NEO  
TOOLS

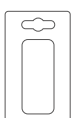

Ref.	⊠ ["]	⊠	EAN
12-655	1/4	0/36	5907558418019
12-656	3/8	0/36	5907558418026



## Kompresor

Compressor / Kompresor / Компрессор / Компресор / Kompreszor / Compressor / Kompresor / Kompresor / Kompresor / Kompresorius / Kompresors / Kompresor / Компресор / Kompresor / Kompresor / Συμπιεστής / Compressor / Compresseur / Compresseur / Compresseur / Compresseur

**NEO**  
TOOLS

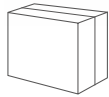

Ref. EAN  
12K020 0/1 5907558453676

**NEO**  
TOOLS

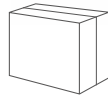

Ref. EAN  
12K021 0/1 5907558453683

**NEO**  
TOOLS

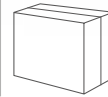

Ref. EAN  
12K022 0/1 5907558453690

## Kompresor olejowy

Compressor - lubricated / Ölkompresor / Компрессор масляный / Компресор олійний / Kompreszor / Compressor cu ulei / Olejový kompresor / Kompresor / Oljni kompresor / Tepalinis kompresorius / Eļļas kompresors / Kompresor (määritud) / Компресор / Kompresor / Kompresor / Συμπιεστής υγραερίσματος / Compressor de aceite / Compresseur ad olio / Compressor de óleo / Compresseur à huile / Olie compressor /

**NEO**  
TOOLS

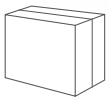

Ref. EAN  
12K030 0/1 5907558453706



**NEO**  
TOOLS

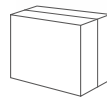

Ref. EAN  
12K031 0/1 5907558453713



**NEO**  
TOOLS

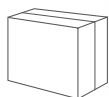

Ref. EAN  
12K010 0/1 5907558439373



## Naolejacz

Oiler / Ölgerät / Смазыватель / Оливоразливаюч / Olajozó pneumatikus / Gresor de ulei / Mazací jednotka / Olejovač / Lubrikator / Tepalinē / Ieeļotājs / Ölitusseade / Смазач / Nauljivač / Podmazivač / Ψεκαστήρας λαδιού / Lubrificador / Oliatore per utensili pneumatici / Máquina oleadora / Huileur / Smeertoestel

**NEO**  
TOOLS

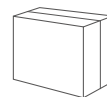

Ref. EAN  
14-552 1/200 5907558444902



## Kompresor olejowy

Compressor - lubricated / Ölkompressor / Компрессор масляный / Компресор олійний / Kompreszor / Compressor cu ulei / Olejový kompresor / Kompresor / Oljní kompresor / Tepalínis kompresorius / Eļļas kompresors / Kompresor (märitud) / Компресор / Kompresor / Kompresor / Συμπιεστής υγραερίων / Compressor de aceite / Compressore ad olio / Compressor de óleo / Compresseur à huile / Olie compressor /

**VERTO**

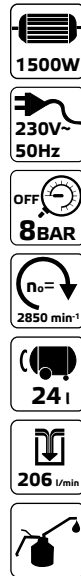

**VERTO**

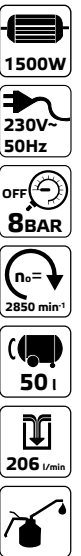

Ref.	P [W]	⊠	EAN
73K002	1500	0/1	5902062730022



Ref.	L [mm]	⊠	EAN
73K004	1500	0/1	5902062730046

## Pistolet do przedmuchiwania

Blowing gun / Pistole zum Durchblasen / Пистолет для продувания / Пистолет до продування / Pneumatikus lefúvatópisztoly / Pistol de baleaj / Pistole pro profukování / Prefukovací pištoľ / Izpihoválna pištoľ / Prapūtimo pistoletas / Saurpūšanas pistole / Lābiloptuspūstol / Пистолет за продуване / Pištoľ za ispuhivanje / Pištoľ za produvanje / Πιστόλι αέρος / Pistola de limpieza a chorro de aire / Pistola aria compressa / Pistola para soprar / Pistolet de soufflage / Afblaaspistool

**NEO**  
TOOLS



**NEO**  
TOOLS



Ref.	⊠	EAN
14-036	10/20	5907558469035



Ref.	L [mm]	⊠	EAN
14-708	-	1/100	5907558452129
14-710	83	1/100	5907558452136
14-712	220	1/40	5907558452143



## Pistolet natryskowy

Spray gun / Sprühpistole / Пистолет-распылитель / Φαρβονιότη / Festékszóró pisztoly / Pistola de duș / Stříkací pistole / Striekacia pištoľ / Brizgalna pištola / Purškimo pistoletas / Pistole-smidzinātājs / Pihustuspüstol / Пистолет - нупееруааор / Pištoľ za prskanje / Pištoľ za prskanje / Πιστόλι ψεκασμού / Pistola de aspersiön / Pistola a spruzzo / Pistola de borrifar / Pistolet à projection / Spuitpistool

**NEO**  
TOOLS



Ref. 14-700  
EAN 5907558452075

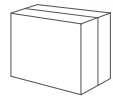

**NEO**  
TOOLS



Ref. 14-702  
EAN 5907558452082

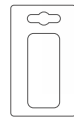

**NEO**  
TOOLS



Ref. 14-703  
EAN 5907558452099

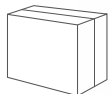

**NEO**  
TOOLS



Ref. 14-704  
EAN 5907558452105

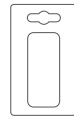

## Zestaw lakierniczy

Lacquer set / Lackierset / Набор для лакирования / Комплект до лакофарбувальних робіт / Kompressor tartozékészlet / Garnitură de lacuit / Lakovací sada / Súprava na lakovanie / Komplet za lakiranje / Komplektas dažytojui / Laku komplekts / Lakkimiskomplekt / Комплект за лакиране / Set za lakiranje / Pribor za lakiranje / Σετ βερνικώματος / Juego de herramientas para barnizado / Pistola a spruzzo in kit / Kit p. Verniz / Jeu d'outils de peinture / Lakset



Ref. 14-220  
EAN 5907558441901

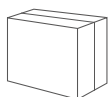

**NEO**  
TOOLS



Ref. 14-699  
EAN 5907558452068

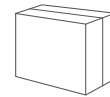



## Pistolet do konserwacji

Maintenance gun / Wartungspistole / Αντιкоррозийный пистолет со шлангом / Фартбульшт / Alvézvédő szórópisztoly tömlővel / Pistol de conservare / Pistole pro údržbu / Konzervačná pištoľ / Pištoľa za nanašanje zaščite / Oro išsiurbimo pistoletas / Konservācijas pistole / Hoolduspüstol / Пистолет за конзервация / Pištoľ za održavanje / Pištoľ za konzerviranje / Πιστόλι ψεκασμού για συντήρηση / Pistola de conservación / Pistola per rivestimenti / Pistola p. Conservação / Pistolet d'entretien / Onderhoudspistool

NEO  
TOOLS



ALU  
BODY

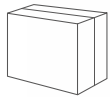

Ref.	📦	EAN
14-720	1/20	5907558452181

## Pistolet do piaskowania

Sandblasting gun / Pistole zum Sandstrahlen / Пескоструйный пистолет с бачком / Пистолет до піскоструменевої обробки / Homokfúvó pisztoly tartállyal / Pistol de sablare / Pískovací pistole / Pieskovacia pištoľ / Pištoľa za peskanje / Smeliavimo pistoletas / Smilštrūklošanas pistole / Liivapriit / Пистолет за масло / Pištoľ za pjeskarenje / Pištoľ za peskarenje / Πιστόλι αμμοβολής / Pistolas de decapado por arena / Pistola per sabbatura / Pistola p. Areia / Pistolet à sablage / Zandblaaspistool

NEO  
TOOLS



ALU  
BODY

1L

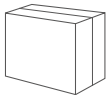

Ref.	📦	EAN
14-724	1/10	5907558452204

NEO  
TOOLS



Ref.	📦	EAN
14-722	0/40	5907558452198

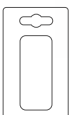

## Pistolet do mycia

Washing gun / Reinigungspistole / Пистолет-распылитель для мытья / Пистолет для миття / Alvézvédő szórópisztoly / Pistol de spălat / Pistole na mytí / Čistiaca pištoľ / Pištoľa za pranje / Plovimo pistoletas / Mazgāšanas pistole / Pesemispüstol / Пистолет за миене / Pištoľ za pranje / Pištoľ za pranje / Πιστόλι πλύσης / Pistola de limpiar / Pistola per pulizia / Pistola p. Limpeza / Pistolet de lavage / Waspistool

NEO  
TOOLS

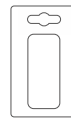

Ref.	📦	EAN
14-706	1/20	5907558452112

## Piasek

Sand / Sand / Песок / Писак / Ásvány homok homokfúvóshoz / Nisip / Pisek / Piesok / Pesek / Dirželis / Smiltis / Liiv / Колан / Pjesak / Pesak / Αμμος / Arena / Sabbia sintetica / Areia / Sable / Zand

NEO  
TOOLS



Ref.	m [kg]	📦	EAN
12-562	1	0/20	5907558417586
12-564	10	0/2	5907558417593

## Wężyk do pompowania

Hose for inflating gun / Schlauch zum Pumpen / Шланг к пистолету / Шланг до пистолету / Kerékfúvató tömlő / Furtun pentru pistol de pompare / Hadička na pufrování / Hadička na pufrovanie / Čev za čpranje / Žarnelè pufpravimui / Caurulite sūkņēšanai / Pumbavoolik / Маркуч за напумване / Сријево за pufpranje / Crevo za pufpranje / Εύκαμπτος σωλήνας πιστολιού / Mangueira para bombear / Tubo di gonfiaggio / Mangueira p. bombar / Flexible de pompage / Pompslang

NEO  
TOOLS



Ref.	L [mm]	📦	EAN
14-820	400	0/100	5907558452280



## Pistolet do pompowania

Inflating gun / Pumpenpistole / Пистолет для подкачки шин / Пistolet до помпування / Kerékfűvató pisztoly nyomásmérővel / Pistol de pompare /umflare / Plnici pistole / Pumpovací pištoľ / Pištoľa za črpanje / Siurbimo pistoletas / Sūkņēšanas pistole / Pūstoļpump / Пистолет за изпомпване / Pištoľ za pumpanje / Πιστόλι φουσκώματος ελαστικών / Pistola para inflar / Gonfiatore per pneumatici / Pistola p. Bomba / Pistolet de pompage / Pomppistol

**NEO**  
TOOLS

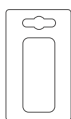

Ref.	Box	EAN
14-714	1/40	5907558452150

**NEO**  
TOOLS

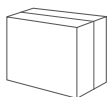

Ref.	Box	EAN
14-716	1/20	5907558452167

**NEO**  
TOOLS

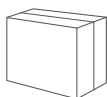

Ref.	Box	EAN
14-718	0/20	5907558452174





NEO GARAGE

**ВНР**  
ОHS ОХОРОНА ПРАЦІ



## Spodnie robocze

Working trousers / Arbeitshose / Брюки рабочие / Штаны рабочие / Munkadzseki / Pantaloni de lucru / Pracovní kalhoty / Montérky / Delovne hlače / Darbinės kelnės / Darba bikses / Тööpüksid / Работни панталони / Radne hlače / Radne pantalone / Παντελόνι εργασίας / Pantalón de trabajo / Pantaloni da lavoro / Calças de trabalho / Pantalon de travail

**NEO**  
TOOLS



Ref.	Size	☒	EAN
80-220-S	S/36	0/24	5907558434330
80-220-M	M/38	0/24	5907558434347
80-220-L	L/40	0/24	5907558434354
80-220-XL	XL/42	0/24	5907558434361
80-220-XXL	XXL/44	0/24	5907558434378

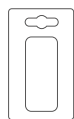

**NEO**  
TOOLS



Ref.	Size	☒	EAN
81-226-XS	XS/46	12/24	5907558446654
81-226-S	S/48	12/24	5907558446661
81-226-M	M/50	12/24	5907558446678
81-226-L	L/52	12/24	5907558446685
81-226-XL	XL/54	12/24	5907558446692
81-226-XXL	XXL/56	12/24	5907558446708
81-226-XXXL	XXXL/58	12/24	5907558446715

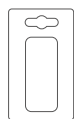

**NEO**  
TOOLS



Możliwość połączenia z bluzą roboczą 81-217 w kombinezon (wewnętrzny suwak)  
Could be matched with jacket 81-217 into jumpsuit by zipper on elastic inner panel  
Можно комбинировать с блузой рабочей 81-217 в кombineзон (пояс на резинке на молнии внутри)

Ref.	Size	☒	EAN
81-227-XS	XS/46	0/24	5907558446937
81-227-S	S/48	0/24	5907558446944
81-227-M	M/50	0/24	5907558446951
81-227-L	L/52	0/24	5907558446968
81-227-XL	XL/54	0/24	5907558446975
81-227-XXL	XXL/56	0/24	5907558446982
81-227-XXXL	XXXL/58	0/24	5907558446999

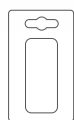

## Spodnie robocze ogrodniczki

Working dungarees / Arbeitslatzhose / Полукомбинезон / Неполнокомбинезон / Munkaruha - kertész nadrág / Pantaloni de lucru cu pieptar / Pracovní kalhoty s laclm / Pracovné pohavice do záhrady / Delovne hlače / Darbinės kelnės (sodininkams) / Dārzniecēs darba bikses / Тöötunked / Градинарски работен панталон / Radne hlače na treger / Pantalone za rad u vrtu / Φάρμα εργασίας με τράντες / Pantalón de trabajo tipo mono / Calças de trabalho / Pantalon de travail salopette / Tuinbroek

**NEO**  
TOOLS



Ref.	Size	☒	EAN
80-240-S	S/36	0/24	5907558434385
80-240-M	M/38	0/24	5907558434392
80-240-L	L/40	0/24	5907558434408
80-240-XL	XL/42	0/24	5907558434415
80-240-XXL	XXL/44	0/24	5907558434422

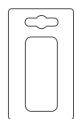

finalist  
of the competition



2019

**NEO**  
TOOLS



Ref.	Size	☒	EAN
81-246-XS	XS/46	0/15	5907558446722
81-246-S	S/48	0/15	5907558446739
81-246-M	M/50	0/15	5907558446746
81-246-L	L/52	0/15	5907558446753
81-246-XL	XL/54	0/15	5907558446760
81-246-XXL	XXL/56	0/15	5907558446777
81-246-XXXL	XXXL/58	0/15	5907558446784

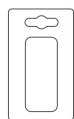

**NEO**  
TOOLS



Ref.	Size	☒	EAN
81-247-XS	XS/46	0/20	5907558447002
81-247-S	S/48	0/20	5907558447019
81-247-M	M/50	0/20	5907558447026
81-247-L	L/52	0/20	5907558447033
81-247-XL	XL/54	0/20	5907558447040
81-247-XXL	XXL/56	0/20	5907558447057
81-247-XXXL	XXXL/58	0/20	5907558447064

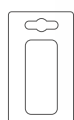

## Spodnie robocze

Working trousers / Arbeitshose / Брюки рабочие / Штаны рабочие / Munkdazseki / Pantaloni de lucru / Pracovní kalhoty / Montérky / Delovne hlače / Darbinės kelnės / Darba bikses / Tööpüksid / Работни панталони / Radne hlače / Radne pantalone / Παντελόνι εργασίας / Pantalón de trabajo / Pantaloni da lavoro / Calças de trabalho / Pantalon de travail

**NEO**  
TOOLS



Ref.	Size	☒	EAN
81-231-XS	XS/46	0/20	5907558447071
81-231-S	S/48	0/20	5907558447088
81-231-M	M/50	0/20	5907558447095
81-231-L	L/52	0/20	5907558447101
81-231-XL	XL/54	0/20	5907558447118
81-231-XXL	XXL/56	0/20	5907558447125
81-231-XXXL	XXXL/58	0/20	5907558447132

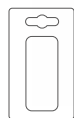

**NEO**  
TOOLS



Ref.	Size	☒	EAN
81-237-XS	XS/46	0/24	5907558481204
81-237-S	S/48	0/24	5907558481211
81-237-M	M/50	0/24	5907558481228
81-237-L	L/52	0/24	5907558481235
81-237-XL	XL/54	0/24	5907558481242
81-237-XXL	XXL/56	0/24	5907558481259
81-237-XXXL	XXXL/58	0/24	5907558481266

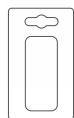

**NEO**  
TOOLS

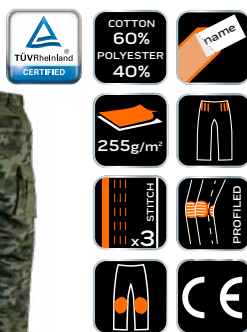

Ref.	Size	☒	EAN
81-221-XS	XS/46	12/24	5907558441970
81-221-S	S/48	12/24	5907558434897
81-221-M	M/50	12/24	5907558434903
81-221-L	L/52	12/24	5907558434910
81-221-XL	XL/54	12/24	5907558434927
81-221-XXL	XXL/56	12/24	5907558434934
81-221-XXXL	XXXL/58	12/24	5907558441987

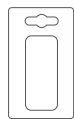

**NEO**  
TOOLS

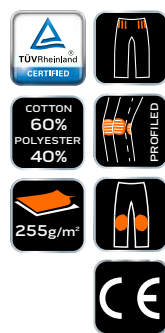

Ref.	Size	☒	EAN
81-222-XS	XS/46	12/24	5907558441994
81-222-S	S/48	12/24	5907558434941
81-222-M	M/50	12/24	5907558434958
81-222-L	L/52	12/24	5907558434965
81-222-XL	XL/54	12/24	5907558434972
81-222-XXL	XXL/56	12/24	5907558434989
81-222-XXXL	XXXL/58	12/24	5907558442007

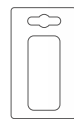

## Spodnie robocze ogrodniczkis

Working dungarees / Arbeitslatzhose / Полукомбинезон / Неполкомбинезон / Munkaruha - kertész nadrág / Pantaloni de lucru cu pieptar / Pracovní kalhoty s lačlem / Pracovné nohavice do záhrady / Delovne hlače / Darbinės kelnės (sodininkams) / Dārzniecības darba bikses / Töötunked / Градинарски работен панталон / Radne hlače na tregere / Pantalone za rad u vrtu / Φόρμα εργασίας με πιάτσες / Pantalón de trabajo tipo mono // Calças de trabalho / Pantalon de travail salopette / Tuinbroek

**NEO**  
TOOLS



Ref.	Size	☒	EAN
81-241-XS	XS/46	10/20	5907558442014
81-241-S	S/48	10/20	5907558434996
81-241-M	M/50	10/20	5907558435009
81-241-L	L/52	10/20	5907558435016
81-241-XL	XL/54	10/20	5907558435023
81-241-XXL	XXL/56	10/20	5907558435030
81-241-XXXL	XXXL/58	10/20	5907558442021

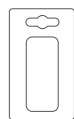

**NEO**  
TOOLS



Ref.	Size	☒	EAN
81-242-XS	XS/46	10/20	5907558442038
81-242-S	S/48	10/20	5907558435047
81-242-M	M/50	10/20	5907558435054
81-242-L	L/52	10/20	5907558435061
81-242-XL	XL/54	10/20	5907558435078
81-242-XXL	XXL/56	10/20	5907558435085
81-242-XXXL	XXXL/58	10/20	5907558442045



## Spodnie robocze ogrodniczki

Working dungarees / Arbeitslatzhose / Полукомбинезон / Непівкомбінезон / Munkaruha - kertész nadrág / Pantaloni de lucru cu pieptar / Pracovní kalhoty s lačlem / Pracovné pohovce do záhrady / Delovne hlače / Darbinės kelinės (sodininkams) / Dārzniecības darba bikses / Тöötunked / Градинарски работен панталон / Radne hlače na treger / Pantalone za rad u vrtu / Φάρμα εργασίας με τράντες / Pantalón de trabajo tipo mono / Calças de trabalho / Pantalon de travail salopette / Tuinbroek

**NEO**  
TOOLS



Ref.	Size	☒	EAN
81-243-XS	XS/46	10/20	5907558443165
81-243-S	S/48	10/20	5907558443172
81-243-M	M/50	10/20	5907558443189
81-243-L	L/52	10/20	5907558443196
81-243-XL	XL/54	10/20	5907558443202
81-243-XXL	XXL/56	10/20	5907558443219

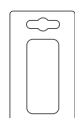

**NEO**  
TOOLS



Ref.	Size	☒	EAN
81-244-XS	XS/46	10/20	5907558444070
81-244-S	S/48	10/20	5907558444087
81-244-M	M/50	10/20	5907558444094
81-244-L	L/52	10/20	5907558444100
81-244-XL	XL/54	10/20	5907558444117
81-244-XXL	XXL/56	10/20	5907558444124
81-244-XXXL	XXXL/58	10/20	5907558444131

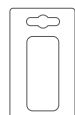

**NEO**  
TOOLS



Ref.	Size	☒	EAN
81-245-S	S/48	10/20	5907558435191
81-245-M	M/50	10/20	5907558435207
81-245-L	L/52	10/20	5907558435214
81-245-XL	XL/54	10/20	5907558435221
81-245-XXL	XXL/56	10/20	5907558435238

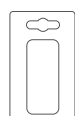

## Spodnie robocze

Working trousers / Arbeitshose / Брюки рабочие / Штаны рабочие / Munkadzseki / Pantaloni de lucru / Pracovní kalhoty / Montérky / Delovne hlače / Darbinės kelinės / Darba bikses / Тööpüksid / Работни панталони / Radne hlače / Radne pantalone / Παντελόν εργασίας / Pantalón de trabajo / Pantaloni da lavoro / Calças de trabalho / Pantalon de travail

**NEO**  
TOOLS



Ref.	Size	☒	EAN
81-224-XS	XS/46	12/24	5907558444001
81-224-S	S/48	12/24	5907558444018
81-224-M	M/50	12/24	5907558444025
81-224-L	L/52	12/24	5907558444032
81-224-XL	XL/54	12/24	5907558444049
81-224-XXL	XXL/56	12/24	5907558444056
81-224-XXXL	XXXL/58	12/24	5907558444063

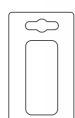

**NEO**  
TOOLS



Ref.	Size	☒	EAN
81-225-S	S/48	0/20	5907558435146
81-225-M	M/50	0/20	5907558435153
81-225-L	L/52	0/20	5907558435160
81-225-XL	XL/54	0/20	5907558435177
81-225-XXL	XXL/56	0/20	5907558435184

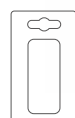

**NEO**  
TOOLS



Ref.	Size	☒	EAN
81-120-S	S/48	0/10	5902062018182
81-120-M	M/50	0/10	5902062018199
81-120-L	L/52	0/10	5902062018205
81-120-LD	L/54	0/10	5902062018212
81-120-XL	XL/56	0/10	5902062018229
81-120-XXL	XXL/58	0/10	5902062018236

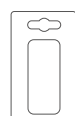

## Spodnie robocze

Working trousers / Arbeitshose / Брюки рабочие / Штани робочі / Munkadzseki / Pantaloni de lucru / Pracovní kalhoty / Montérky / Delovne hlače / Darbinės kelnės / Darba bikses / Тööpüksid / Работни панталони / Radne hlače / Radne pantalone / Παντελόνι εργασίας / Pantalón de trabajo / Pantaloni da lavoro / Calças de trabalho / Pantalon de travail

**NEO**  
TOOLS



Ref.	Size	☒	EAN
81-140-S	S/48	0/10	5902062018243
81-140-M	M/50	0/10	5902062018250
81-140-L	L/52	0/10	5902062018267
81-140-LD	L/54	0/10	5902062018274
81-140-XL	XL/56	0/10	5902062018281
81-140-XXL	XXL/58	0/10	5902062018298

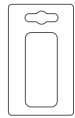

## Spodnie robocze ogrodniczki

Working dungarees / Arbeitslatzhose / Полукомбинезон / Ημιπνοκμβινεζον / Munkaruha - kertész nadrág / Pantaloni de lucru cu pieptar / Pracovní kalhoty s laclm / Pracovné nohavice do záhrady / Delovne hlače / Darbinės kelnės (sodininkams) / Dārznieces darba bikses / Тöötunked / Градинарски работен панталон / Radne hlače na tregere / Pantalone za rad u vrtu / Φόρμα εργασίας με τράντες / Pantalón de trabajo tipo mono // Calças de trabalho / Pantalon de travail salopette / Tuinbroek

**NEO**  
TOOLS



Ref.	Size	☒	EAN
81-248-XS	XS/46	0/20	5907558451795
81-248-S	S/48	0/20	5907558451801
81-248-M	M/50	0/20	5907558451818
81-248-L	L/52	0/20	5907558451825
81-248-XL	XL/54	0/20	5907558451832
81-248-XXL	XXL/56	0/20	5907558451849
81-248-XXXL	XXXL/58	0/20	5907558451856

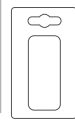

## Spodnie robocze

Working trousers / Arbeitshose / Брюки рабочие / Штани робочі / Munkadzseki / Pantaloni de lucru / Pracovní kalhoty / Montérky / Delovne hlače / Darbinės kelnės / Darba bikses / Тööpüksid / Работни панталони / Radne hlače / Radne pantalone / Παντελόνι εργασίας / Pantalón de trabajo / Pantaloni da lavoro / Calças de trabalho / Pantalon de travail

**NEO**  
TOOLS



Ref.	Size	☒	EAN
81-238-XS	XS/46	0/20	5907558451658
81-238-S	S/48	0/20	5907558451665
81-238-M	M/50	0/20	5907558451672
81-238-L	L/52	0/20	5907558451689
81-238-XL	XL/54	0/20	5907558451696
81-238-XXL	XXL/56	0/20	5907558451702
81-238-XXXL	XXXL/58	0/20	5907558451719

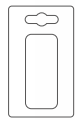

**NEO**  
TOOLS



Ref.	Size	☒	EAN
81-239-XS	XS/46	0/20	5907558451726
81-239-S	S/48	0/20	5907558451733
81-239-M	M/50	0/20	5907558451740
81-239-L	L/52	0/20	5907558451757
81-239-XL	XL/54	0/20	5907558451764
81-239-XXL	XXL/56	0/20	5907558451771
81-239-XXXL	XXXL/58	0/20	5907558451788

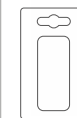

**NEO**  
TOOLS

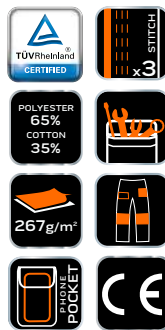

Ref.	Size	☒	EAN
81-220-S	S/48	0/10	5907558419085
81-220-M	M/50	0/10	5907558419092
81-220-L	L/52	0/10	5907558419108
81-220-LD	L/54	0/10	5907558419115
81-220-XL	XL/56	0/10	5907558419122
81-220-XXL	XXL/58	0/10	5907558419139

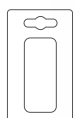

**NEO**  
TOOLS



Ref.	Size	☒	EAN
81-230-S	S/48	0/10	5907558419146
81-230-M	M/50	0/10	5907558419153
81-230-L	L/52	0/10	5907558419160
81-230-LD	L/54	0/10	5907558419177
81-230-XL	XL/56	0/10	5907558419184
81-230-XXL	XXL/58	0/10	5907558419191

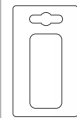

## Spodnie robocze na szelkach

Working trousers with suspenders / Arbeitslatzhose / ПолукOMBINEЗОН РАБОЧИЙ / ПівкOMBINEЗОН РАБОЧИЙ / Kantáros munkanadrág / Pantaloni de lucru cu bretele / Montérkové kalhoty / Montérky na traky / Delovne hlače z naramnicami / Darbinės kelnės su petnešomis / Darba puskombinezons / Traksidēga tōōpūksid / Работни панталони с тиранту / Radne farmer hlače / Radne pantalone sa tregerima / Φάρμα εργασίας τράντα / Pantalón de trabajo con tirantes / Salopette de lavoro / Jardineiras de trabalho / Pantalon de travail sur bretelles

NEO  
TOOLS



Ref.	Size	☒	EAN
81-240-S	S/48	0/10	5907558419207
81-240-M	M/50	0/10	5907558419214
81-240-L	L/52	0/10	5907558419221
81-240-LD	L/54	0/10	5907558419238
81-240-XL	XL/56	0/10	5907558419245
81-240-XXL	XXL/58	0/10	5907558419252

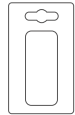

NEO  
TOOLS



Ref.	Size	☒	EAN
81-321-XS	XS/46	0/20	5907558453058
81-321-S	S/48	0/20	5907558453065
81-321-M	M/50	0/20	5907558453072
81-321-L	L/52	0/20	5907558453089
81-321-XL	XL/54	0/20	5907558453096
81-321-XXL	XXL/56	0/20	5907558453102
81-321-XXXL	XXXL/58	0/20	5907558453119

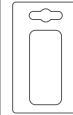

## Spodnie robocze

Working trousers / Arbeitshose / Брюки рабочие / Штаны рабочие / Munkadzseki / Pantaloni de lucru / Pracovní kalhoty / Montérky / Delovne hlače / Darbinės kelnės / Darba bikses / Tōōpūksid / Работни панталони / Radne hlače / Radne pantalone / Παντελόνι εργασίας / Pantalón de trabajo / Pantaloni da lavoro / Calças de trabalho / Pantalon de travail

NEO  
TOOLS



Ref.	Size	☒	EAN
81-325-XS	XS/46	0/20	5907558453126
81-325-S	S/48	0/20	5907558453133
81-325-M	M/50	0/20	5907558453140
81-325-L	L/52	0/20	5907558453157
81-325-XL	XL/54	0/20	5907558453164
81-325-XXL	XXL/56	0/20	5907558453171
81-325-XXXL	XXXL/58	0/20	5907558453188

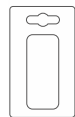

NEO  
TOOLS



Ref.	Size	☒	EAN
81-236-XS	XS/46	0/20	5907558467840
81-236-S	S/48	0/20	5907558467857
81-236-M	M/50	0/20	5907558467864
81-236-L	L/52	0/20	5907558467871
81-236-XL	XL/54	0/20	5907558467888
81-236-XXL	XXL/56	0/20	5907558467895
81-236-XXXL	XXXL/58	0/20	5907558467901



NEO  
TOOLS



Ref.	Size	☒	EAN
81-228-XS	XS/46	0/20	5907558439427
81-228-S	S/48	0/20	5907558439434
81-228-M	M/50	0/20	5907558439441
81-228-L	L/52	0/20	5907558439458
81-228-XL	XL/54	0/20	5907558439465
81-228-XXL	XXL/56	0/20	5907558439472
81-228-XXXL	XXXL/58	0/20	5907558439489



NEO  
TOOLS



Ref.	Size	☒	EAN
81-233-XS	XS/46	0/20	5907558467703
81-233-S	S/48	0/20	5907558467710
81-233-M	M/50	0/20	5907558467727
81-233-L	L/52	0/20	5907558467734
81-233-XL	XL/54	0/20	5907558467741
81-233-XXL	XXL/56	0/20	5907558467758
81-233-XXXL	XXXL/58	0/20	5907558467765





## Spodnie robocze

Working trousers / Arbeitshose / Брюки рабочие / Штани робочі / Munkadzseki / Pantaloni de lucru / Pracovní kalhoty / Montérky / Delovne hlače / Darbinės kelnės / Darba bikses / Тööpüksid / Работни панталони / Radne hlače / Radne pantalone / Παντελόνι εργασίας / Pantalón de trabajo / Pantaloni da lavoro / Calças de trabalho / Pantalon de travail

**NEO**  
TOOLS



finalist  
of the competition



2020

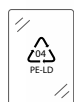

Ref.	Size	☒	EAN
81-229-XS	XS/46	0/20	5907558439496
81-229-S	S/48	0/20	5907558439502
81-229-M	M/50	0/20	5907558439519
81-229-L	L/52	0/20	5907558443127
81-229-XL	XL/54	0/20	5907558443134
81-229-XXL	XXL/56	0/20	5907558439540
81-229-XXXL	XXXL/58	0/20	5907558439557

**NEO**  
TOOLS

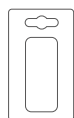

Ref.	Size	☒	EAN
81-420-S	S/48	0/10	5907558415445
81-420-M	M/50	0/10	5907558415452
81-420-L	L/52	0/10	5907558415469
81-420-LD	L/54	0/10	5907558415476
81-420-XL	XL/56	0/10	5907558415483
81-420-XXL	XXL/58	0/10	5907558415490

## Kpl. odzieży roboczej

Set of workwear / Satz Arbeitskleidung / Комплект спецодежды / Комплект спецодягу / Munkaruha készlet / Set de haine de lucru / Sada pracovných odiev / Súprava pracovného oblečenia / Komplet delovnih oblačil / Darbo aprangos komplektas / Darba apģērbu komplekts / Тööriiete komplekt / Комплект работной одежды / Set radne odjece / Комплект радне одеће / Σετ ρούχων εργασίας / Conjunto de ropa de trabajo / Set di abiti da lavoro / Conjunto de roupa de trabalho / Ensemble de vêtements de travail

**NEO**  
TOOLS

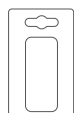

Ref.	Size	☒	EAN
81-450-S	S/48	0/10	5907558483369
81-450-M	M/50	0/10	5907558483376
81-450-L	L/52	0/10	5907558483383
81-450-XL	XL/54	0/10	5907558483390
81-450-XXL	XXL/56	0/10	5907558483406
81-450-XXXL	XXXL/58	0/10	5907558483413

## Spodnie robocze na szelkach

Working trousers with suspenders / Arbeitslatzhose / Полумкомбінезон робочий / Півкомбінезон робочий / Kantáros munkanadrág / Pantaloni de lucru cu bretele / Montérkové kalhoty / Montérky na traky / Delovne hlače z naramnicami / Darbinės kelnės su petnešomis / Darba puskombinezons / Traksidēga tőöpüksid / Работни панталони с тиранима / Radne farmer hlače / Radne pantalone sa tregerima / Φόρμα εργασίας πρίντρα / Pantalón de trabajo con tirantes / Salopette da lavoro / Jardineiras de trabalho / Pantalon de travail sur bretelles

**NEO**  
TOOLS



Ref.	Size	☒	EAN
81-430-S	S/48	0/10	5907558415506
81-430-M	M/50	0/10	5907558415513
81-430-L	L/52	0/10	5907558415520
81-430-LD	L/54	0/10	5907558415537
81-430-XL	XL/56	0/10	5907558415544
81-430-XXL	XXL/58	0/10	5907558415551

## Spodnie robocze

Working trousers / Arbeitshose / Брюки рабочие / Штани робочі / Munkadzseki / Pantaloni de lucru / Pracovní kalhoty / Montérky / Delovne hlače / Darbinės kelnės / Darba bikses / Тööpüksid / Работни панталони / Radne hlače / Radne pantalone / Παντελόνι εργασίας / Pantalón de trabajo / Pantaloni da lavoro / Calças de trabalho / Pantalon de travail

**NEO**  
TOOLS



Ref.	Size	☒	EAN
81-451-S	S/48	0/20	5907558486025
81-451-M	M/50	0/20	5907558486018
81-451-L	L/52	0/20	5907558486001
81-451-XL	XL/54	0/20	5907558486032
81-451-XXL	XXL/56	0/20	5907558486049
81-451-XXXL	XXXL/58	0/20	5907558486056

**NEO**  
TOOLS



Ref.	Size	☒	EAN
81-565-S	S/48	0/10	5907558428247
81-565-M	M/50	0/10	5907558428254
81-565-L	L/52	0/10	5907558428261
81-565-XL	XL/56	0/10	5907558428278
81-565-XXL	XXL/58	0/10	5907558428285
81-565-XXXL	XXXL/60	0/10	5907558428292

## Spodnie robocze

Working trousers / Arbeitshose / Брюки рабочие / Штаны рабочие / Munkadzseki / Pantaloni de lucru / Pracovní kalhoty / Montérky / Delovne hlače / Darbinės kelnės / Darba bikses / Tööpüksid / Работни панталони / Radne hlače / Radne pantalone / Παντελόνι εργασίας / Pantalón de trabajo / Pantaloni da lavoro / Calças de trabalho / Pantalon de travail

NEO  
TOOLS

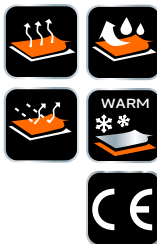

Ref.	Size	☒	EAN
81-566-S	S/48	0/20	5907558428186
81-566-M	M/50	0/20	5907558428193
81-566-L	L/52	0/20	5907558428209
81-566-XL	XL/56	0/20	5907558428216
81-566-XXL	XXL/58	0/20	5907558428223
81-566-XXXL	XXXL/60	0/20	5907558428230



## Spodnie przeciwdeszczowe

Rainproof trousers / Regen hose / Брюки влагозащитные / Штаны дощові / Esővédő nadrág / Pantaloni de ploaie / Kalhoty do deště / Nepremokavé nohavice / Dežne hlače / Lietaus kelnės / Lietus bikses / Vihmapiüksid / Панталон против дъжд / Hlače za zaštitu od kiše / Pantalone za zaštitu od kiše / Παντελόνι για προστασία από την υγρασία / Pantalones de lluvia / Pantaloni impermeabili / Calças impermeáveis / Pantalon de pluie / Regenbroek /

NEO  
TOOLS



Ref.	Size	☒	EAN
81-811-M	M/50	0/20	5907558444292
81-811-L	L/52	0/20	5907558444308
81-811-XL	XL/56	0/20	5907558444315
81-811-XXL	XXL/58	0/20	5907558444322
81-811-XXXL	XXXL/60	0/20	5907558444339



## Kombinezon roboczy

Working overalls / Arbeitsoverall / Комбинезон рабочий / Комбинезон робочий / Overall / Combinezon de lucru / Pracovní kombinéza / Pracovná kombinéza / Delovni kombinezon / Darbinis kombinezonas / Darba kombinezons / Töökombinesoon / Работен комбинезон / Radni kombinezon / Radni kombinezon / Φόρμα εργασίας / Mono de trabajo / Tuta da lavoro / Macacão de trabalho / Combinaison de travail

NEO  
TOOLS



Ref.	Size	☒	EAN
81-258-XS	XS/46	0/15	5907558451863
81-258-S	S/48	0/15	5907558451870
81-258-M	M/50	0/15	5907558451887
81-258-L	L/52	0/15	5907558451894
81-258-XL	XL/56	0/15	5907558451900
81-258-XXL	XXL/58	0/15	5907558451917
81-258-XXXL	XXXL/60	0/15	5907558451924

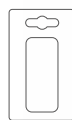

NEO  
TOOLS



Ref.	Size	☒	EAN
81-250-S	S/48	0/10	5907558419269
81-250-M	M/50	0/10	5907558419276
81-250-L	L/52	0/10	5907558419283
81-250-LD	L/54	0/10	5907558419290
81-250-XL	XL/56	0/10	5907558419306
81-250-XXL	XXL/58	0/10	5907558419313

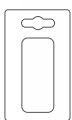

## Spodnie robocze na szelkach

Working trousers with suspenders / Arbeitslatzhose / Полумкомбинезон робочий / Півкомбинезон робочий / Kantáros munkanadrág / Pantaloni de lucru cu bretele / Montérkové kalhoty / Montérky na traky / Delovne hlače z naramnicami / Darbinės kelnės su petnešomis / Darba puskombinezons / Traksidiega tööpüksid / Работни панталони с тиранту / Radne farmer hlače / Radne pantalone sa tregerima / Φόρμα εργασίας τράντα / Pantalón de trabajo con tirantes / Salopette da lavoro / Jardineiras de trabalho / Pantalon de travail sur bretelles

NEO  
TOOLS



Ref.	Size	☒	EAN
81-779-S	S/48	0/10	5907558430028
81-779-M	M/50	0/10	5907558430035
81-779-L	L/52	0/10	5907558430042
81-779-XL	XL/56	0/10	5907558430059
81-779-XXL	XXL/58	0/10	5907558430066



NEO  
TOOLS



Ref.	Size	☒	EAN
81-775-S	S/48	0/10	5907558429688
81-775-M	M/50	0/10	5907558429695
81-775-L	L/52	0/10	5907558429756
81-775-XL	XL/56	0/10	5907558429718
81-775-XXL	XXL/58	0/10	5907558429725

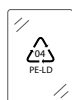

## Spodnie robocze na szelkach

Working trousers with suspenders / Arbeitslatzhose / Полумбинезон рабочий / Півкомбінезон рабочий / Kantáros munkanadrág / Pantaloni de lucru cu bretele / Montérkové kalhoty / Montérky na traky / Delovne hlače z naramnicami / Darbinės kelnės su petnešomis / Darba puskombinezons / Traksidaga tööpüksid / Работни панталони с тиранту / Radne farmer hlače / Radne pantalone sa tregerima / Φάρμα εργασιών πράντα / Pantalón de trabajo con tirantes / Salopette da lavoro / Jardineiras de trabalho / Pantalon de travail sur bretelles

**NEO**  
TOOLS



Ref.	Size	☒	EAN
81-776-S	S/48	0/10	5907558429732
81-776-M	M/50	0/10	5907558429749
81-776-L	L/52	0/10	5907558429756
81-776-XL	XL/56	0/10	5907558429763
81-776-XXL	XXL/58	0/10	5907558429770



**NEO**  
TOOLS



Ref.	Size	☒	EAN
81-777-S	S/48	0/10	5907558429787
81-777-M	M/50	0/10	5907558429794
81-777-L	L/52	0/10	5907558429800
81-777-XL	XL/56	0/10	5907558429817
81-777-XXL	XXL/58	0/10	5907558429824

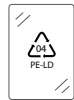

**NEO**  
TOOLS



Ref.	Size	☒	EAN
81-778-S	S/48	0/10	5907558429831
81-778-M	M/50	0/10	5907558429848
81-778-L	L/52	0/10	5907558429855
81-778-XL	XL/56	0/10	5907558429862
81-778-XXL	XXL/58	0/10	5907558429879



## Spodnie robocze

Working trousers / Arbeitshose / Брюки рабочие / Штаны рабочие / Munkadzseki / Pantaloni de lucru / Pracovní kalhoty / Montérky / Delovne hlače / Darbinės kelnės / Darba bikses / Tööpüksid / Работни панталони / Radne hlače / Radne pantalone / Παντελόν εργασιών / Pantalón de trabajo / Pantaloni da lavoro / Calças de trabalho / Pantalon de travail

**NEO**  
TOOLS



Ref.	Size	☒	EAN
81-792-S	S/48	0/20	5902062062932
81-792-M	M/50	0/20	5902062062949
81-792-L	L/52	0/20	5902062062956
81-792-XL	XL/56	0/20	5902062062963
81-792-XXL	XXL/58	0/20	5902062062970
81-792-XXXL	XXXL/60	0/20	5902062062987

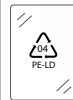

**NEO**  
TOOLS



Ref.	Size	☒	EAN
81-750-S	S/48	0/20	5907558428513
81-750-M	M/50	0/20	5907558428520
81-750-L	L/52	0/20	5907558428537
81-750-XL	XL/56	0/20	5907558428544
81-750-XXL	XXL/58	0/20	5907558428551
81-750-XXXL	XXXL/60	0/20	5907558428568

**NEO**  
TOOLS

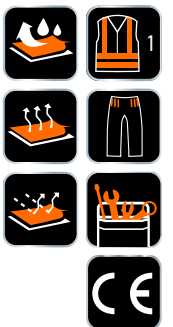

Ref.	Size	☒	EAN
81-751-S	S/48	0/20	5907558429039
81-751-M	M/50	0/20	5907558429046
81-751-L	L/52	0/20	5907558429053
81-751-XL	XL/56	0/20	5907558429060
81-751-XXL	XXL/58	0/20	5907558429077
81-751-XXXL	XXXL/60	0/20	5907558429084



## Spodnie robocze

Working trousers / Arbeitshose / Брюки рабочие / Штаны робочі / Munkadzseki / Pantaloni de lucru / Pracovní kalhoty / Montérky / Delovne hlače / Darbinės kelnės / Darba bikses / Тööpüksid / Работни панталони / Radne hlače / Radne pantalone / Παντελόνι εργασίας / Pantalón de trabajo / Pantaloni da lavoro / Calças de trabalho / Pantalon de travail

**NEO**  
TOOLS

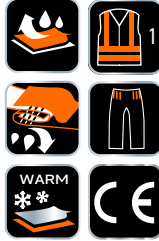

Ref.	Size	☒	EAN
81-760-S	S/48	0/10	5907558428575
81-760-M	M/50	0/10	5907558428582
81-760-L	L/52	0/10	5907558428599
81-760-XL	XL/56	0/10	5907558428605
81-760-XXL	XXL/58	0/10	5907558428612
81-760-XXXL	XXXL/60	0/10	5907558428629

**NEO**  
TOOLS

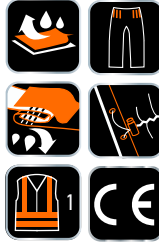

Ref.	Size	☒	EAN
81-770-S	S/48	0/10	5907558428636
81-770-M	M/50	0/10	5907558428643
81-770-L	L/52	0/10	5907558428650
81-770-XL	XL/56	0/10	5907558428667
81-770-XXL	XXL/58	0/10	5907558428674
81-770-XXXL	XXXL/60	0/10	5907558428681

**NEO**  
TOOLS



Ref.	Size	☒	EAN
81-771-S	S/48	0/10	5907558429152
81-771-M	M/50	0/10	5907558429169
81-771-L	L/52	0/10	5907558429176
81-771-XL	XL/56	0/10	5907558429183
81-771-XXL	XXL/58	0/10	5907558429190
81-771-XXXL	XXXL/60	0/10	5907558429206

## Krótkie spodniki

Shorts / Kurz hose / Шорты / Коротки Штаны / Rövidnadrág / Pantaloni Scurți / Kratasy / Krátke Nohavice / Krátke Hlače / Darbiniai Šortai / Šorti / Lühikesed Püksid / Къси Панталони / Krátke Hlače / Krátke Pantalone / Βερμούδες / Pantalones Cortos / Pantaloncini Corti / Calças Curtas / Culotte / Korte Broek

**NEO**  
TOOLS



Ref.	Size	☒	EAN
81-276-XS	XS/46	0/24	5907558446791
81-276-S	S/48	0/24	5907558446807
81-276-M	M/50	0/24	5907558446814
81-276-L	L/52	0/24	5907558446821
81-276-XL	XL/54	0/24	5907558446838
81-276-XXL	XXL/56	0/24	5907558446845
81-276-XXXL	XXXL/58	0/24	5907558446852

**NEO**  
TOOLS



Ref.	Size	☒	EAN
81-273-XS	XS/46		5907558467772
81-273-S	S/48		5907558467789
81-273-M	M/50		5907558467796
81-273-L	L/52		5907558467802
81-273-XL	XL/54		5907558467819
81-273-XXL	XXL/56		5907558467826
81-273-XXXL	XXXL/58		5907558467833

**NEO**  
TOOLS



Ref.	Size	☒	EAN
81-279-XS	XS/46	0/20	5907558439861
81-279-S	S/48	0/20	5907558439878
81-279-M	M/50	0/20	5907558439885
81-279-L	L/52	0/20	5907558439892
81-279-XL	XL/54	0/20	5907558439908
81-279-XXL	XXL/56	0/20	5907558439915
81-279-XXXL	XXXL/58	0/20	5907558439922



## Krótkie spodniki

Shorts / Kurzhose / Шорты / Κορτοκι Σμάνου / Rövidnadrág / Pantaloni Scurți / Kratasy / Krátke Nohavice / Kratke Hlače / Darbiniai Šortai / Šorti / Lühikesed Püksid / Къси Панталонки / Kratke Hlače / Kratke Pantalone / Βερμούδες / Pantalones Cortos / Pantaloncini Corti / Calças Curtas / Culotte / Korte Broek

**NEO**  
TOOLS



**NEO**  
TOOLS



Ref.	Size	☒	EAN
81-271-XS	XS/46	16/32	5907558442410
81-271-S	S/48	16/32	5907558442427
81-271-M	M/50	16/32	5907558442434
81-271-L	L/52	16/32	5907558442441
81-271-XL	XL/54	16/32	5907558442458
81-271-XXL	XXL/56	16/32	5907558442465
81-271-XXXL	XXXL/58	16/32	5907558442472

Ref.	Size	☒	EAN
81-278-XS	XS/46	0/20	5907558451993
81-278-S	S/48	0/20	5907558452006
81-278-M	M/50	0/20	5907558452013
81-278-L	L/52	0/20	5907558452020
81-278-XL	XL/54	0/20	5907558452037
81-278-XXL	XXL/56	0/20	5907558452044
81-278-XXXL	XXXL/58	0/20	5907558452051

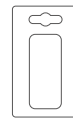
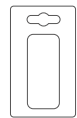

**NEO**  
TOOLS



**NEO**  
TOOLS



Ref.	Size	☒	EAN
81-270-S	S/48	0/10	5907558426595
81-270-M	M/50	0/10	5907558426601
81-270-L	L/52	0/10	5907558426618
81-270-LD	LD/54	0/10	5907558427066
81-270-XL	XL/56	0/10	5907558426625
81-270-XXL	XXL/58	0/10	5907558426632

Ref.	Size	☒	EAN
81-330-S	S/48	0/10	5907558426649
81-330-M	M/50	0/10	5907558426656
81-330-L	L/52	0/10	5907558426663
81-330-LD	LD/54	0/10	5907558427073

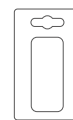
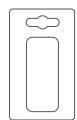

**NEO**  
TOOLS



**NEO**  
TOOLS



Ref.	Size	☒	EAN
81-331-XS	XS/46	0/20	5907558453195
81-331-S	S/48	0/20	5907558453201
81-331-M	M/50	0/20	5907558453218
81-331-L	L/52	0/20	5907558453225
81-331-XL	XL/54	0/20	5907558453232
81-331-XXL	XXL/56	0/20	5907558453249
81-331-XXXL	XXXL/58	0/20	5907558453256

Ref.	Size	☒	EAN
81-440-S	S/48	0/10	5907558426694
81-440-M	M/50	0/10	5907558426700
81-440-L	L/52	0/10	5907558426717
81-440-LD	LD/54	0/10	5907558427080
81-440-XL	XL/56	0/10	5907558426724
81-440-XXL	XXL/58	0/10	5907558426731

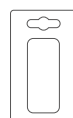
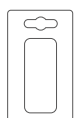

## Krótkie spodenki

Shorts / Kurzhose / Шорты / Короткі Штаны / Rövidnadrág / Pantaloni Scurți / Kratasy / Krátke Nohavice / Krátke Hlače / Darbiniai Šortai / Šorti / Lühikesed Püksid / Къси Панталонки / Krátke Hlače / Krátke Pantalone / Βερμούδες / Pantalones Cortos / Pantaloncini Corti / Calças Curtas / Culotte / Korte Broek

**NEO**  
TOOLS



**NEO**  
TOOLS



Ref.	Size	☒	EAN
81-780-S	S/48	0/20	5907558429589
81-780-M	M/50	0/20	5907558429596
81-780-L	L/52	0/20	5907558429602
81-780-XL	XL/56	0/20	5907558429619
81-780-XXL	XXL/58	0/20	5907558429626

Ref.	Size	☒	EAN
81-781-S	S/48	0/20	5907558429633
81-781-M	M/50	0/20	5907558429640
81-781-L	L/52	0/20	5907558429657
81-781-XL	XL/56	0/20	5907558429664
81-781-XXL	XXL/58	0/20	5907558429671



**NEO**  
TOOLS



**NEO**  
TOOLS



Ref.	Size	☒	EAN
81-782-S	S/48	0/50	5907558429923
81-782-M	M/50	0/50	5907558429930
81-782-L	L/52	0/50	5907558429947
81-782-XL	XL/56	0/50	5907558429954
81-782-XXL	XXL/58	0/50	5907558429961

Ref.	Size	☒	EAN
81-783-S	S/48	0/50	5907558429978
81-783-M	M/50	0/50	5907558429985
81-783-L	L/52	0/50	5907558429992
81-783-XL	XL/56	0/50	5907558430004
81-783-XXL	XXL/58	0/50	5907558430011

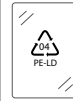

## Bluza robocza

Working top / Arbeitsshirt / Блуза рабочая / Куртка рабоча / Munkadzseki / Blusa de lucru / Pracovní blůza / Pracovná bunda / Delovna jakna / Darbiniai marškiniai / Darba kreklis / Төўжак / Работна блуза / Radna bluza / Radna bluza / Μηλούζα εργασίας / Sudadera de trabajo / Giacca da lavoro / Blusão de trabalho / Veste de travail

**NEO**  
TOOLS



**NEO**  
TOOLS



Ref.	Size	☒	EAN
81-216-S	S/48	0/20	5907558446593
81-216-M	M/50	0/20	5907558446609
81-216-L	L/52	0/20	5907558446616
81-216-XL	XL/54	0/20	5907558446623
81-216-XXL	XXL/56	0/20	5907558446630
81-216-XXXL	XXXL/58	0/20	5907558446647

Ref.	Size	☒	EAN
81-217-XS	XS/46	0/20	5907558446869
81-217-S	S/48	0/20	5907558446876
81-217-M	M/50	0/20	5907558446883
81-217-L	L/52	0/20	5907558446890
81-217-XL	XL/54	0/20	5907558446906
81-217-XXL	XXL/56	0/20	5907558446913
81-217-XXXL	XXXL/58	0/20	5907558446920

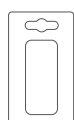

Możliwość połączenia ze spodniami roboczymi 81-227 w kombinezon (elastyczny pas z zamkiem w środku)  
Can be matched with jacket 81-227 into a jumpsuit (elastic waistband with a zipper inside)  
Можно комбинировать с брюками рабочими 81-227 в кombineзон (пояс на резинке на молнии внутри)



## Bluza robocza

Working top / Arbeitsshirt / Блуза рабочая / Куртка рабочая / Munkadzseki / Blusa de lucru / Pracovní blůza / Pracovná bunda / Delovna jakna / Darbiniai marškiniai / Darba krekls / Tööjakk / Рабочна блуза / Radna bluz / Radna bluz / Μπλούζα εργασις / Sudadera de trabajo / Giacca da lavoro / Blusaõ de trabalho / Veste de travail

**NEO**  
TOOLS



Ref.	Size	☒	EAN
81-207-S	S/48		5907558481143
81-207-M	M/50		5907558481150
81-207-L	L/52		5907558481167
81-207-XL	XL/54		5907558481174
81-207-XXL	XXL/56		5907558481181
81-207-XXXL	XXXL/58		5907558481198

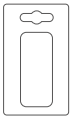

**NEO**  
TOOLS



Ref.	Size	☒	EAN
81-213-S	S/48	0/20	5907558443035
81-213-M	M/50	0/20	5907558443042
81-213-L	L/52	0/20	5907558443059
81-213-XL	XL/54	0/20	5907558443066
81-213-XXL	XXL/56	0/20	5907558443073
81-213-XXXL	XXXL/58	0/20	5907558443080

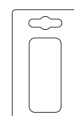

**NEO**  
TOOLS



Ref.	Size	☒	EAN
81-211-S	S/48	0/20	5907558434842
81-211-M	M/50	0/20	5907558434859
81-211-L	L/52	0/20	5907558434866
81-211-XL	XL/54	0/20	5907558434873
81-211-XXL	XXL/56	0/20	5907558434880
81-211-XXXL	XXXL/58	0/20	5907558441963

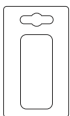

**NEO**  
TOOLS



Ref.	Size	☒	EAN
81-215-S	S/48	0/20	5907558435092
81-215-M	M/50	0/20	5907558435108
81-215-L	L/52	0/20	5907558435115
81-215-XL	XL/54	0/20	5907558435122
81-215-XXL	XXL/56	0/20	5907558435139

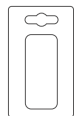

**NEO**  
TOOLS



Ref.	Size	☒	EAN
81-110-S	S/48	0/10	5902062018120
81-110-M	M/50	0/10	5902062018137
81-110-L	L/52	0/10	5902062018144
81-110-LD	LD/54	0/10	5902062018151
81-110-XL	XL/56	0/10	5902062018168
81-110-XXL	XXL/58	0/10	5902062018175

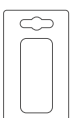

**NEO**  
TOOLS



Ref.	Size	☒	EAN
81-218-S	S/48	0/20	5907558451597
81-218-M	M/50	0/20	5907558451603
81-218-L	L/52	0/20	5907558451610
81-218-XL	XL/54	0/20	5907558451627
81-218-XXL	XXL/56	0/20	5907558451634
81-218-XXXL	XXXL/58	0/20	5907558451641

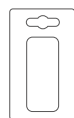

## Bluza robocza

Working top / Arbeitsshirt / Блуза рабочая / Куртка рабочая / Munkadzseki / Blusa de lucru / Pracovní blůza / Pracovná bunda / Delovna jakna / Darbiniai marškiniai / Darba kreklis / Töjajakk / Работна блуза / Radna bluza / Radna bluza / Μπλουζα εργασις / Sudadera de trabajo / Giacca da lavoro / Blusão de trabalho / Veste de travail

**NEO**  
TOOLS



**NEO**  
TOOLS



Ref.	Size	☒	EAN
81-210-S	S/48	0/10	5907558419023
81-210-M	M/50	0/10	5907558419030
81-210-L	L/52	0/10	5907558419047
81-210-LD	L/54	0/10	5907558419054
81-210-XL	XL/56	0/10	5907558419061
81-210-XXL	XXL/58	0/10	5907558419078

Ref.	Size	☒	EAN
81-310-S	S/48	0/10	5907558419375
81-310-M	M/50	0/10	5907558419382
81-310-L	L/52	0/10	5907558419399
81-310-LD	L/54	0/10	5907558419405
81-310-XL	XL/56	0/10	5907558419412
81-310-XXL	XXL/58	0/10	5907558419429

**NEO**  
TOOLS

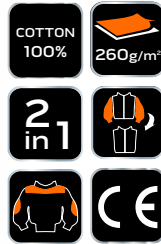

**NEO**  
TOOLS



Ref.	Size	☒	EAN
81-311-S	S/48	0/20	5907558452990
81-311-M	M/50	0/20	5907558453003
81-311-L	L/52	0/20	5907558453010
81-311-XL	L/54	0/20	5907558453027
81-311-XXL	XL/56	0/20	5907558453034
81-311-XXXL	XXL/58	0/20	5907558453041

Ref.	Size	☒	EAN
81-410-S	S/48	0/10	5907558415384
81-410-M	M/50	0/10	5907558415391
81-410-L	L/52	0/10	5907558415407
81-410-LD	L/54	0/10	5907558415414
81-410-XL	XL/56	0/10	5907558415421
81-410-XXL	XXL/58	0/10	5907558415438

## Bluza polarowa

Polar fleece jacket / Arbeitskittel aus Polarfleece / Блуза из флиса / Маїстерка / Polár munkadzseki / Blusa polar / Fleeceová mikina / Flísová bunda / Jopič iz flisa / Džemperis iš poliarinio fliso audinio / Flíša jaka / Fliis / Блузка от фроты / Blusa od polara / Jakna / Μπλουζα φλις / Chaqueta de polar / Giacca in pile / Camisola polar / Polo polaire / Fleece trui

**NEO**  
TOOLS



**NEO**  
TOOLS



Ref.	Size	☒	EAN
80-500-S	S/48	0/14	5907558434132
80-500-M	M/50	0/14	5907558434149
80-500-L	L/52	0/14	5907558434156
80-500-XL	XL/54	0/14	5907558434163
80-500-XXL	XXL/56	0/14	5907558434170

Ref.	Size	☒	EAN
81-506-S	S/48	0/13	5907558441482
81-506-M	M/50	0/13	5907558441499
81-506-L	L/52	0/13	5907558441505
81-506-XL	XL/54	0/13	5907558441512
81-506-XXL	XXL/56	0/13	5907558441529
81-506-XXXL	XXXL/58	0/13	5907558441536





## Bluza polarowa

Polar fleece jacket / Arbeitskittel aus Polarfleece / Блуза из флиса / Мајстерка / Polár munkadzseki / Bluza polar / Fleeceová mikina / Flíssová bunda / Jopić iz flisa / Džemperis iš polarinio fliso audinio / Flíša jaka / Flís / Блузка от флоры / Bluza od polara / Jakna / Μηλούζα φλις / Chaqueta de polar / Giacca in pile / Camisola polar / Polo polaire / Fleece trui

**NEO**  
TOOLS



Ref.	Size	☒	EAN
81-505-S	S/48	0/15	5907558434699
81-505-M	M/50	0/15	5907558434705
81-505-L	L/52	0/15	5907558434712
81-505-XL	XL/54	0/15	5907558434729
81-505-XXL	XXL/56	0/15	5907558434736

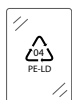

**NEO**  
TOOLS



Ref.	Size	☒	EAN
81-500-S	S/48	0/20	5907558419498
81-500-M	M/50	0/20	5907558419504
81-500-L	L/52	0/20	5907558419511
81-500-XL	XL/56	0/20	5907558419528
81-500-XXL	XXL/58	0/20	5907558419535



**NEO**  
TOOLS



Ref.	Size	☒	EAN
81-501-S	S/48	0/20	5907558429237
81-501-M	M/50	0/20	5907558429244
81-501-L	L/52	0/20	5907558429251
81-501-XL	XL/56	0/20	5907558429268
81-501-XXL	XXL/58	0/20	5907558429275

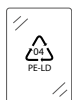

## Bluza dziana

Knitted sweatshirt / Strickbluse / Тенная блуза / Блуза трикотажна / Kötött blúz / Bluz tricotaj / Pletená mikina / Pletená bunda / Pletena bluza / Džemperis / Trikotāžas sporta džemperis / Trikotāzist dressipluus / Телефон за работа при тежку условя / Bluza od pletenine / Pletena bluza / Μηλούζα πλεκτή στημιού / Sudadera de punto / Felpa in tessuto / Blusão em malha / Blouson tricot / Katoenen trui

**NEO**  
TOOLS



Ref.	Size	☒	EAN
80-555-S	S/48	0/10	5907558433500
80-555-M	M/50	0/10	5907558433517
80-555-L	L/52	0/10	5907558433524
80-555-XL	XL/54	0/10	5907558433531
80-555-XXL	XXL/56	0/10	5907558433548

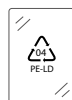

**NEO**  
TOOLS



Ref.	Size	☒	EAN
81-555-S	S/48	0/10	5907558428063
81-555-M	M/50	0/10	5907558428070
81-555-L	L/52	0/10	5907558428087
81-555-XL	XL/56	0/10	5907558428094
81-555-XXL	XXL/58	0/10	5907558428100
81-555-XXXL	XXL/60	0/10	5907558428117



**NEO**  
TOOLS



Ref.	Size	☒	EAN
81-511-S	S/48	0/20	5907558441420
81-511-M	M/50	0/20	5907558441437
81-511-L	L/52	0/20	5907558441444
81-511-XL	XL/54	0/20	5907558441451
81-511-XXL	XXL/56	0/20	5907558441468
81-511-XXXL	XXXL/58	0/20	5907558441475

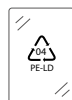

## Bluza robocza

Working top / Arbeitsshirt / Рабочая толстовка / Куртка рабоча / Munkadzseki / Bluza de lucru / Pracovní blůza / Pracovná bunda / Delovna jakna / Darbiniai marškiniai / Darba kreklis / Tööjakk / Рабочна блуза / Radna bluza / Radna bluza / Μπλούζα εργασίας / Sudadera de trabajo / Giacca da lavoro / Blusão de trabalho / Veste de travail

**NEO**  
TOOLS



Ref.	Size	☒	EAN
81-512-S	S/48	0/15	5907558439687
81-512-M	M/50	0/15	5907558439694
81-512-L	L/52	0/15	5907558439700
81-512-XL	XL/54	0/15	5907558439717
81-512-XXL	XXL/56	0/15	5907558439724
81-512-XXXL	XXXL/58	0/15	5907558439731



**NEO**  
TOOLS



Ref.	Size	☒	EAN
81-556-S	S/48	0/10	5907558428124
81-556-M	M/50	0/10	5907558428131
81-556-L	L/52	0/10	5907558428148
81-556-XL	XL/56	0/10	5907558428155
81-556-XXL	XXL/58	0/10	5907558428162
81-556-XXXL	XXXL/60	0/10	5907558428179



**NEO**  
TOOLS



Ref.	Size	☒	EAN
81-742-S	S/48	0/20	5902062062871
81-742-M	M/50	0/20	5902062062888
81-742-L	L/52	0/20	5902062062895
81-742-XL	XL/56	0/20	5902062062901
81-742-XXL	XXL/58	0/20	5902062062918
81-742-XXXL	XXXL/60	0/20	5902062062925



## Bluza polarowa ostrzegawcza

Fleece jacket / Fleece-Pullover / Блуза из флиса / Маўстэрка / Láthatósági polár / Bluza polar / Fleeceová mikina / Flísová bunda / Jopič iz flisa / Džemperis iš poliarinio fliso audinio / Flíša jaka / Flíis / Блузка от флоры / Bluza od polara / Jakna / Μπλουζα φλις / Chaqueta de polar / Giacca da lavoro alta visibilità in pile / Camisola polar / Polo polaire / Fleece trui

**NEO**  
TOOLS



**NEO**  
TOOLS



Ref.	Size	☒	EAN
81-740-S	S/48	0/20	5907558431452
81-740-M	M/50	0/20	5907558431469
81-740-L	L/52	0/20	5907558431476
81-740-XL	XL/56	0/20	5907558431483
81-740-XXL	XXL/58	0/20	5907558431490

Ref.	Size	☒	EAN
81-741-S	S/48	0/20	5907558431506
81-741-M	M/50	0/20	5907558431513
81-741-L	L/52	0/20	5907558431520
81-741-XL	XL/56	0/20	5907558431537
81-741-XXL	XXL/58	0/20	5907558431544

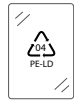

**NEO**  
TOOLS



**NEO**  
TOOLS



Ref.	Size	☒	EAN
81-745-S	S/48	0/10	5907558429282
81-745-M	M/50	0/10	5907558429299
81-745-L	L/52	0/10	5907558429305
81-745-XL	XL/56	0/10	5907558429312
81-745-XXL	XXL/58	0/10	5907558429329

Ref.	Size	☒	EAN
81-746-S	S/48	0/10	5907558429336
81-746-M	M/50	0/10	5907558429343
81-746-L	L/52	0/10	5907558429350
81-746-XL	XL/56	0/10	5907558429367
81-746-XXL	XXL/58	0/10	5907558429374

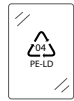

## Softshell ostrzegawczy

Work jacket / Arbeitsjacke / Куртка рабочая / Куртка робоча / Láthatósági munkadzseki / Jacheta de lucru / Pracovní bunda / Pracovní bunda / Delovni jopič / Darbinė striukė / Darba jaka / Тööjope / Работно яке / Radna jakna / Radnička jakna / Μπουφάν εργασίας / Chaqueta de trabajo / Giacca da lavoro alta visibilità in softshell / Blusão de trabalho / Veste de travail

**NEO**  
TOOLS



**NEO**  
TOOLS



Ref.	Size	☒	EAN
81-700-S	S/48	0/10	5907558428339
81-700-M	M/50	0/10	5907558428346
81-700-L	L/52	0/10	5907558428353
81-700-XL	XL/56	0/10	5907558428360
81-700-XXL	XXL/58	0/10	5907558431254
81-700-XXXL	XXXL/60	0/10	5907558431261

Ref.	Size	☒	EAN
81-701-S	S/48	0/10	5907558428858
81-701-M	M/50	0/10	5907558428865
81-701-L	L/52	0/10	5907558428872
81-701-XL	XL/56	0/10	5907558428889
81-701-XXL	XXL/58	0/10	5907558428896
81-701-XXXL	XXL/60	0/10	5907558428902

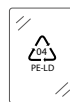
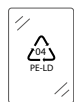

## Kurtka softshell

Waterproof, windproof jacket, softshell / Wind- und wasserdichte Softshelljacke / Куртка водо- и ветронепроницаемая, softshell / Вирівка з водовідштовхувальної тканини «softshell» / Softshell munkadzseki / Djaka impermeabila, antivânt, softshell / Vodoodolná, větruvzdorná, softshellová bunda / Vodoodolná, vetruodolná, softshellová bunda / Jakna, odporna na vodu, veter, softshell / Vėjui ir vandeniui atspari striukė („softshell“) / Udensnecaurlaidīga vējjaka, softshell / Softshell vee- ja tuulekindel jope / Блуза от непоп / Vodooporna, vjetrooporna jakna softshell / Jakna otporna na vodu, vetar, sa mekim jezgrom / Αδιάβροχο μπλουζάκι για προστασία από τον αέρα / Chaqueta impermeable, antiviento, softshell / Giacca antivento, anti pioggia, softshell / Casaco corta vento impermeável softshell / Blouse imperméable pare-brise softshell

NEO  
TOOLS



Ref.	Size	☒	EAN
80-550-S	S/48	0/10	5907558433555
80-550-M	M/50	0/10	5907558433562
80-550-L	L/52	0/10	5907558433579
80-550-XL	XL/54	0/10	5907558433586
80-550-XXL	XXL/56	0/10	5907558433593



NEO  
TOOLS



Ref.	Size	☒	EAN
81-559-S	S/48	0/10	5907558441840
81-559-M	M/50	0/10	5907558441857
81-559-L	L/52	0/10	5907558441864
81-559-XL	XL/54	0/10	5907558441871
81-559-XXL	XXL/56	0/10	5907558441888
81-559-XXXL	XXXL/58	0/10	5907558441895

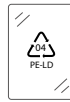

NEO  
TOOLS



Ref.	Size	☒	EAN
81-553-S	S/48	0/10	5907558434644
81-553-M	M/50	0/10	5907558434651
81-553-L	L/52	0/10	5907558434668
81-553-XL	XL/54	0/10	5907558434675
81-553-XXL	XXL/56	0/10	5907558434682



NEO  
TOOLS

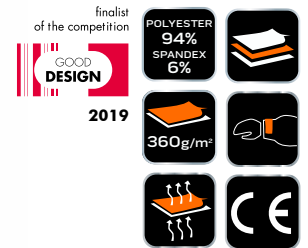

Ref.	Size	☒	EAN
81-558-S	S/48	0/10	5907558434798
81-558-M	M/50	0/10	5907558434804
81-558-L	L/52	0/10	5907558434811
81-558-XL	XL/54	0/10	5907558434828
81-558-XXL	XXL/56	0/10	5907558434835



NEO  
TOOLS



Ref.	Size	☒	EAN
81-551-S	S/48	0/10	5907558427943
81-551-M	M/50	0/10	5907558427950
81-551-L	L/52	0/10	5907558427967
81-551-XL	XL/56	0/10	5907558427974
81-551-XXL	XXL/58	0/10	5907558427981
81-551-XXXL	XXXL/60	0/10	5907558427998



NEO  
TOOLS

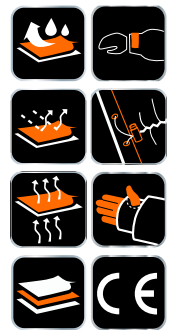

Ref.	Size	☒	EAN
81-550-S	S/48	0/10	5907558419542
81-550-M	M/50	0/10	5907558419559
81-550-L	L/52	0/10	5907558419566
81-550-XL	XL/56	0/10	5907558419573
81-550-XXL	XXL/58	0/10	5907558419580

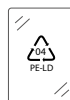

## Kurtka robocza

Work jacket / Arbeitsjacke / Куртка рабочая / Kurtka robocza / Munkadzseki steppelt / Jacheta de lucru / Pracovní bunda / Pracovná bunda / Delovni jopič / Darbinė striukė / Darba jaka / Тööjope / Работно яке / Radna jakna / Radnička jakna / Μπουφάν εργαίας / Chaqueta de trabajo / Giacca da lavoro imbottita / Blusão de trabalho / Veste de travail

**NEO**  
TOOLS



**NEO**  
TOOLS

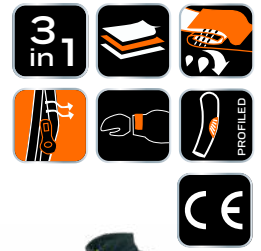

Ref.	Size	☒	EAN
81-571-S	S/48	0/10	5907558441666
81-571-M	M/50	0/10	5907558441673
81-571-L	L/52	0/10	5907558441680
81-571-XL	XL/54	0/10	5907558441697
81-571-XXL	XXL/56	0/10	5907558441703
81-571-XXXL	XXXL/58	0/10	5907558441710

Ref.	Size	☒	EAN
81-572-S	S/48	0/10	5907558441727
81-572-M	M/50	0/10	5907558441734
81-572-L	L/52	0/10	5907558441741
81-572-XL	XL/54	0/10	5907558441758
81-572-XXL	XXL/56	0/10	5907558441765
81-572-XXXL	XXXL/58	0/10	5907558441772



**NEO**  
TOOLS



**NEO**  
TOOLS



Ref.	Size	☒	EAN
81-573-S	S/48	0/10	5907558460254
81-573-M	M/50	0/10	5907558460261
81-573-L	L/52	0/10	5907558460278
81-573-XL	XL/54	0/10	5907558460285
81-573-XXL	XXL/56	0/10	5907558460292
81-573-XXXL	XXXL/58	0/10	5907558460308

Ref.	Size	☒	EAN
81-574-S	S/48	0/10	5907558460315
81-574-M	M/50	0/10	5907558460322
81-574-L	L/52	0/10	5907558460339
81-574-XL	XL/54	0/10	5907558460346
81-574-XXL	XXL/56	0/10	5907558460353
81-574-XXXL	XXXL/58	0/10	5907558460360



**NEO**  
TOOLS



**NEO**  
TOOLS



Ref.	Size	☒	EAN
81-575-S	S/48	0/10	5907558460377
81-575-M	M/50	0/10	5907558460384
81-575-L	L/52	0/10	5907558460391
81-575-XL	XL/54	0/10	5907558460407
81-575-XXL	XXL/56	0/10	5907558460414
81-575-XXXL	XXXL/58	0/10	5907558460421

Ref.	Size	☒	EAN
81-570-S	S/48	0/10	5907558421705
81-570-M	M/50	0/10	5907558421712
81-570-L	L/52	0/10	5907558421729
81-570-XL	XL/56	0/10	5907558421736
81-570-XXL	XXL/58	0/10	5907558421743

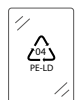

## Kurtka robocza

Work jacket / Arbeitsjacke / Куртка рабочая / Куртка робоча / Munkadzseki steppelt / Jacheta de lucru / Pracovní bunda / Pracovná bunda / Delovni jopič / Darbinė striukė / Darba jaka / Тööjope / Работно яке / Radna jakna / Radnička jakna / Μπουφάν εργαίας / Chaqueta de trabajo / Giacca da lavoro imbottita / Blusão de trabalho / Veste de travail

NEO  
TOOLS



NEO  
TOOLS



Ref.	Size	☒	EAN
81-557-S	S/48	0/10	5907558439564
81-557-M	M/50	0/10	5907558439571
81-557-L	L/52	0/10	5907558439588
81-557-XL	XL/54	0/10	5907558439595
81-557-XXL	XXL/56	0/10	5907558439601
81-557-XXXL	XXXL/58	0/10	5907558439618

Ref.	Size	☒	EAN
81-720-S	S/48	0/20	5907558431339
81-720-M	M/50	0/20	5907558431346
81-720-L	L/52	0/20	5907558431353
81-720-XL	XL/56	0/20	5907558431360
81-720-XXL	XXL/58	0/20	5907558428490
81-720-XXXL	XXXL/60	0/20	5907558428506

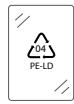

## Ocieplana kurtka robocza

Work jacket / Arbeitsjacke / Куртка рабочая / Куртка робоча / Látathósági munkadzseki / Jacheta de lucru / Pracovní bunda / Pracovná bunda / Delovni jopič / Darbinė striukė / Darba jaka / Тööjope / Работно яке / Radna jakna / Radnička jakna / Μπουφάν εργαίας / Chaqueta de trabajo / Giacca da lavoro alta visibilità isolata / Blusão de trabalho / Veste de travail

NEO  
TOOLS



NEO  
TOOLS



Ref.	Size	☒	EAN
81-710-S	S/48	0/10	5907558431278
81-710-M	M/50	0/10	5907558431285
81-710-L	L/52	0/10	5907558431292
81-710-XL	XL/56	0/10	5907558431308
81-710-XXL	XXL/58	0/10	5907558431315
81-710-XXXL	XXXL/60	0/10	5907558431322

Ref.	Size	☒	EAN
81-711-S	S/48	0/10	5907558428919
81-711-M	M/50	0/10	5907558428926
81-711-L	L/52	0/10	5907558428933
81-711-XL	XL/56	0/10	5907558428940
81-711-XXL	XXL/58	0/10	5907558428957
81-711-XXXL	XXXL/60	0/10	5907558428964

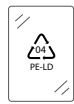

## Kurtka wiatrówka

Windbreaker jacket / Windbreaker Jacke / Ветропна куртка / Куртка з вітром / Széldzseki kabát / Jacheta pentru parbriz / Bunda s větrovkou / Bunda vetrovku / Jakna za vetrovko / Windbreaker\* striukė / Vėjaka jaka / Tuulejope jope / Сако за вятър / Jakna od vjetrovke / Jakna za vetrobran / Αντανεμικό μπουφάν / Chaqueta rompivientos / Giacca a vento / Casaco corta-vento / Veste coupe-vent

NEO  
TOOLS

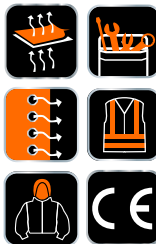

Ref.	Size	☒	EAN
81-561-S	S/48	0/30	5907558448207
81-561-M	M/50	0/30	5907558448214
81-561-L	L/52	0/30	5907558448221
81-561-XL	XL/54	0/30	5907558448238
81-561-XXL	XXL/56	0/30	5907558448245

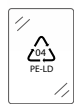

## Kurtka przeciwdeszczowa

Rainproof jacket / Regenmante / Куртка влагозащитная / Куртка дощова / Esővédő kabát / Geacă de ploaie / Bunda do deště / Nepremokavá bunda / Dežna jakna / Striukė nuo lietaus / Lietus jaka / Vihmajope / Яке против дождя / Kaput za zaštitu od kiše / Jakna za zaštitu od kiše / Μπουφάν για προστασία από την υγρασία / Chaquetón impermeable / Giacca impermeabile / Casaco impermeável / Veste de pluie / Regenjas

NEO  
TOOLS



Ref.	Size	☒	EAN
81-810-M	M/50	0/20	5907558444247
81-810-L	L/52	0/20	5907558444254
81-810-XL	XL/54	0/20	5907558444261
81-810-XXL	XXL/56	0/20	5907558444278
81-810-XXXL	XXXL/58	0/20	5907558444285



## Komplet przeciwdeszczowy

Rainproof set / Regenset / Дождевой комплект / Комплект дощовий / Esővédő szett / Set de ploaie / Sada do deště / Nepremokavá súprava / Dežni komplet / Komplektas nuo lietaus / Lietus komplekts / Vihhariete komplekt / Комплект против дождя / Set za zaštitu od kiše / Komplet za zaštitu od kiše / Σετ βροχής / Kit de lluvia / Completo impermeabile / Kit impermeável / Ensemble de pluie / Regenset

NEO  
TOOLS



Ref.	Size	☒	EAN
81-800-M	M/50	0/20	5907558444193
81-800-L	L/52	0/20	5907558444209
81-800-XL	XL/54	0/20	5907558444216
81-800-XXL	XXL/56	0/20	5907558444223
81-800-XXXL	XXXL/58	0/20	5907558444230



## T-shirt

T-shirt / T-Shirt / Футболка сигнальная / Футболка / Póló / T-shirt / Tričko / Tričko / Majica / Apatiniai marškinėliai - T / T-kreklis / T-särk / Тушэpm / T-shirt / Majica kratkih rukava / Κομπούνηκη μπλούζα / Camiseta / Maglietta / Camisola / T-shirt / T-shirt

NEO  
TOOLS

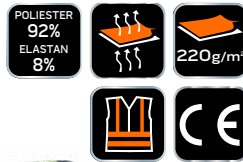

Ref.	Size	☒	EAN
81-614-S	S/48	0/50	5907558441543
81-614-M	M/50	0/50	5907558441550
81-614-L	L/52	0/50	5907558441567
81-614-XL	XL/54	0/50	5907558441574
81-614-XXL	XXL/56	0/50	5907558441581
81-614-XXXL	XXXL/58	0/50	5907558441598

NEO  
TOOLS



Ref.	Size	☒	EAN
81-647-S	S/48	0/50	5907558483000
81-647-M	M/50	0/50	5907558483017
81-647-L	L/52	0/50	5907558483024
81-647-XL	XL/54	0/50	5907558483031
81-647-XXL	XXL/56	0/50	5907558483048
81-647-XXXL	XXXL/58	0/50	5907558483055

NEO  
TOOLS



Ref.	Size	☒	EAN
81-648-S	S/48	0/50	5907558482942
81-648-M	M/50	0/50	5907558482959
81-648-L	L/52	0/50	5907558482966
81-648-XL	XL/54	0/50	5907558482973
81-648-XXL	XXL/56	0/50	5907558482980
81-648-XXXL	XXXL/58	0/50	5907558482997

NEO  
TOOLS



Ref.	Size	☒	EAN
81-649-S	S/48	0/50	5907558482881
81-649-M	M/50	0/50	5907558482898
81-649-L	L/52	0/50	5907558482904
81-649-XL	XL/54	0/50	5907558482911
81-649-XXL	XXL/56	0/50	5907558482928
81-649-XXXL	XXXL/58	0/50	5907558482935



## T-shirt

T-shirt / T-Shirt / Футболка сигнальная / Футболка / Póló / Tričko / Tričko / Majica / Apatiniai marškinėliai - T / T-kreklis / T-särk / Тушэрт / T-shirt / Majica kratkih rukava / Κορτομάνικη μπλούζα / Camiseta / Maglietta / Camisola / T-shirt / T-shirt

**NEO**  
TOOLS



Ref.	Size	☒	EAN
81-640-M	M/50	0/50	5907558483420
81-640-L	L/52	0/50	5907558483437
81-640-XL	XL/54	0/50	5907558483444
81-640-XXL	XXL/56	0/50	5907558483451
81-640-XXXL	XXXL/58	0/50	5907558483468

**NEO**  
TOOLS



Ref.	Size	☒	EAN
81-641-M	M/50	0/50	5907558483475
81-641-L	L/52	0/50	5907558483482
81-641-XL	XL/54	0/50	5907558483499
81-641-XXL	XXL/56	0/50	5907558483505
81-641-XXXL	XXXL/58	0/50	5907558483512

**NEO**  
TOOLS



Ref.	Size	☒	EAN
81-642-M	M/50	0/50	5907558483529
81-642-L	L/52	0/50	5907558483536
81-642-XL	XL/54	0/50	5907558483543
81-642-XXL	XXL/56	0/50	5907558483550
81-642-XXXL	XXXL/58	0/50	5907558483567

**NEO**  
TOOLS



Ref.	Size	☒	EAN
81-643-M	M/50	0/50	5907558483574
81-643-L	L/52	0/50	5907558483581
81-643-XL	XL/54	0/50	5907558483598
81-643-XXL	XXL/56	0/50	5907558483604
81-643-XXXL	XXXL/58	0/50	5907558483611

**NEO**  
TOOLS



Ref.	Size	☒	EAN
81-652-S	S/48	0/50	5907558481273
81-652-M	M/50	0/50	5907558481280
81-652-L	L/52	0/50	5907558481297
81-652-XL	XL/54	0/50	5907558481303
81-652-XXL	XXL/56	0/50	5907558481310
81-652-XXXL	XXXL/58	0/50	5907558481327

**NEO**  
TOOLS



Ref.	Size	☒	EAN
81-612-S	S/48	0/50	5907558432121
81-612-M	M/50	0/50	5907558432138
81-612-L	L/52	0/50	5907558432145
81-612-XL	XL/54	0/50	5907558432152
81-612-XXL	XXL/56	0/50	5907558432169

**NEO**  
TOOLS



Ref.	Size	☒	EAN
81-604-S	S/48	0/50	5907558460117
81-604-M	M/50	0/50	5907558460124
81-604-L	L/52	0/50	5907558460131
81-604-XL	XL/54	0/50	5907558460148
81-604-XXL	XXL/56	0/50	5907558460155
81-604-XXXL	XXXL/58	0/50	5907558460162

**NEO**  
TOOLS



Ref.	Size	☒	EAN
81-603-S	S/48	0/50	5907558443233
81-603-M	M/50	0/50	5907558443240
81-603-L	L/52	0/50	5907558443257
81-603-XL	XL/54	0/50	5907558443264
81-603-XXL	XXL/56	0/50	5907558443271
81-603-XXXL	XXXL/58	0/50	5907558443288





## T-shirt

T-shirt / T-Shirt / Футболка сигнальная / Футболка / Póló / T-shirt / Tričko / Tričko / Majica / Apatiniai marškinėliai - T / T-kreklis / T-särk / Тушэрт / T-shirt / Majica kratkih rukava / Κορτομάνικη μπλούζα / Camiseta / Maglietta / Camisola / T-shirt / T-shirt

**NEO**  
TOOLS

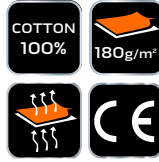

Ref.	Size	☒	EAN
81-613-S	S/48	0/50	5907558435245
81-613-M	M/50	0/50	5907558435252
81-613-L	L/52	0/50	5907558435269
81-613-XL	XL/54	0/50	5907558435276
81-613-XXL	XXL/56	0/50	5907558435283



**NEO**  
TOOLS



Ref.	Size	☒	EAN
81-602-S	S/48	0/50	5907558439748
81-602-M	M/50	0/50	5907558439755
81-602-L	L/52	0/50	5907558439762
81-602-XL	XL/54	0/50	5907558439779
81-602-XXL	XXL/56	0/50	5907558439786
81-602-XXXL	XXXL/58	0/50	5907558439793



**NEO**  
TOOLS

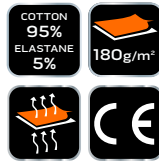

Ref.	Size	☒	EAN
80-610-S	S/36	0/50	5907558434231
80-610-M	M/38	0/50	5907558434248
80-610-L	L/40	0/50	5907558434255
80-610-XL	XL/42	0/50	5907558434262
80-610-XXL	XXL/44	0/50	5907558434279



**NEO**  
TOOLS



Ref.	Size	☒	EAN
80-611-S	S/36	0/50	5907558434286
80-611-M	M/38	0/50	5907558434293
80-611-L	L/40	0/50	5907558434309
80-611-XL	XL/42	0/50	5907558434316
80-611-XXL	XXL/44	0/50	5907558434323



**NEO**  
TOOLS

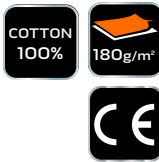

Ref.	Size	☒	EAN
81-610-S	S/48	0/50	5907558432022
81-610-M	M/50	0/50	5907558432039
81-610-L	L/52	0/50	5907558432046
81-610-XL	XL/54	0/50	5907558432053
81-610-XXL	XXL/56	0/50	5907558432060



**NEO**  
TOOLS

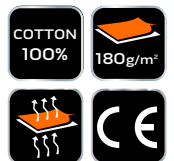

Ref.	Size	☒	EAN
81-615-S	S/48	0/50	5907558435344
81-615-M	M/50	0/50	5907558435351
81-615-L	L/52	0/50	5907558435368
81-615-XL	XL/54	0/50	5907558435375
81-615-XXL	XXL/56	0/50	5907558435382

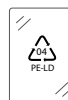

## Koszulka polo

Polo shirt / Polo-Shirt / Футболка-поло / Сорочка-поло / Pólóing / Camasa din tesatura / Tričko polo / Polokošeľa / Majica z onratnikom / Marškiniai „Polo“ / Polo krekls / Polosärk / Блузка поло / Polo majica / Polo majica / Κοτομάνικη μπλούζα πόλο / Camiseta polo Polo / Camisa pólo / Chemise polo / Polo shirt

**NEO**  
TOOLS



Ref.	Size	☒	EAN
81-606-S	S/48	0/40	5907558439809
81-606-M	M/50	0/40	5907558439816
81-606-L	L/52	0/40	5907558439823
81-606-XL	XL/54	0/40	5907558439830
81-606-XXL	XXL/56	0/40	5907558439847
81-606-XXXL	XXXL/58	0/40	5907558439854

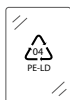

**NEO**  
TOOLS



Ref.	Size	☒	EAN
81-659-S	S/48	0/25	5907558467918
81-659-M	M/50	0/25	5907558467925
81-659-L	L/52	0/25	5907558467932
81-659-XL	XL/54	0/25	5907558467949
81-659-XXL	XXL/56	0/25	5907558467956
81-659-XXXL	XXXL/58	0/25	5907558467963

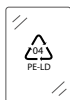

**NEO**  
TOOLS



Ref.	Size	☒	EAN
81-657-S	S/48	0/50	5907558481334
81-657-M	M/50	0/50	5907558481341
81-657-L	L/52	0/50	5907558481358
81-657-XL	XL/54	0/50	5907558481365
81-657-XXL	XXL/56	0/50	5907558481372
81-657-XXXL	XXXL/58	0/50	5907558481389

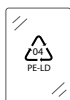

## Koszulka z długim rękawem

Longsleeve / Langarm-Shirt / Футболка с длинными рукавами / Сорочка з довгим рукавом / Hosszú ujjú ing / Cămașă cu mânecă lungă / Tričko s dlouhým rukávem / Tričko s dlhým rukávom / Srajca z dolgimi rokavi / Marškiniaius ilgomis rankovėmis / Krekls ar garām piedurknēm / Pikkade varrukatega säärk / Блузка с дълга ръкав / Majica dugih rukava / Košulja sa dugim rukavima / Μηλούζακι μακρομάνικο / Camisa de manga larga / Maglietta a manica lunga

**NEO**  
TOOLS

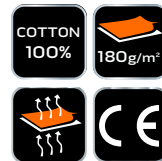

Ref.	Size	☒	EAN
81-619-S	S/48	0/40	5907558441604
81-619-M	M/50	0/40	5907558441611
81-619-L	L/52	0/40	5907558441628
81-619-XL	XL/54	0/40	5907558441635
81-619-XXL	XXL/56	0/40	5907558441642
81-619-XXXL	XXXL/58	0/40	5907558441659



## T-shirt ostrzegawczy

High visibility T-shirt / T-Shirt / Футболка сигнальная / Футболка / Láthatósági póló / T-shirt / Tričko / Tričko / Majica / Apatiniai marškinėliai - T / T-krekls / T-särk / Тульшоп / T-shirt / Majica kratkih rukava / Κοτομάνικη μπλούζα / Camiseta / T-Shirt alta visibilità / Camisola / T-shirt / T-shirt

**NEO**  
TOOLS

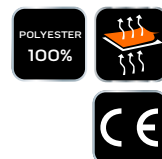

Ref.	Size	☒	EAN
81-730-S	S/48	0/50	5907558429381
81-730-M	M/50	0/50	5907558429398
81-730-L	L/52	0/50	5907558429404
81-730-XL	XL/56	0/50	5907558429411
81-730-XXL	XXL/58	0/50	5907558429428

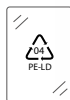

**NEO**  
TOOLS

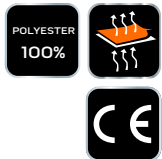

Ref.	Size	☒	EAN
81-731-S	S/48	0/50	5907558429435
81-731-M	M/50	0/50	5907558429442
81-731-L	L/52	0/50	5907558429459
81-731-XL	XL/56	0/50	5907558429466
81-731-XXL	XXL/58	0/50	5907558429473



**NEO**  
TOOLS

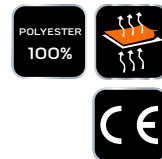

Ref.	Size	☒	EAN
81-732-S	S/48	0/50	5907558429923
81-732-M	M/50	0/50	5907558429930
81-732-L	L/52	0/50	5907558429947
81-732-XL	XL/56	0/50	5907558429954
81-732-XXL	XXL/58	0/50	5907558429961

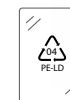

## Kamizelka ostrzegawcza

Warning jacket / Warnweste / Жилет светоотражающий / Жилет світловідбивний / Biztonsági mellény / Jacheta reflectorizanta / Vystržná vesta / Reflexná vesta / Opozorilni brezrokavnik / Apsauginė liemenė / Drošības veste / Hoiatusvest / Елек сигнален / Prsluk / Prsluk / Σακάκι με χρώμα προειδοποίησης / Chaleco de seguridad / Giubbotto di avvertimento / Colete de advertência / Gilet d'avertissement / Waarschuwingsvest

NEO  
TOOLS



Ref.	Size	☒	EAN
81-735-L	L/52	0/100	5907558471038
81-735-XL	XL/54	0/100	5907558471045
81-735-XXL	XXL/56	0/100	5907558471052

## Szelki odblaskowe

Reflective harness / Reflektierendes Gurtzeug / Светоотражающие ремни / Світловідбиваючий джсцям / Fényvisszaverő hám / Harnasament reflectorizant / Reflexní postroj / Reflexný postroj / Odsevni pasovi / Atspindintys diržai / Atstarojošās siksnas / Peegeldav rakmed / Светлоотрабателни колане / Reflektirajući pojasi / Рефлективни појас / Ανακλαστικός μίνας / Arnês reflectante / Imbracatura riflettente / Arnês reflector / Harnas réfléchissant / Reflektierend harnas

NEO  
TOOLS



Ref.	☒	EAN
81-736	0/60	5907558483116

## Bezrękaownik roboczy

Work body warmer / Arbeitsweste / Жилет робочий / Безрукавка робоча / Mellény fényvisszaverő / Vesta de lucru / Pracovní vesta / Pracovní vesta / Delovni brezrokavnik / Darbinė liemenė / Darba jaka bez piedurknēm / Töövest / Работен елек / Radni prsluk / Radnički prsluk / Гилеко ергасіас / Chaleco de trabajo / Gilet da lavoro doppio uso / Blusa de trabalho sem mangas / Gilet de travail

NEO  
TOOLS



NEO  
TOOLS

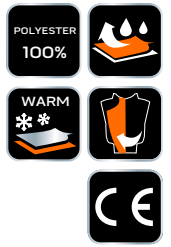

Ref.	Size	☒	EAN
81-533-S	S/48	0/10	5907558434743
81-533-M	M/50	0/10	5907558434750
81-533-L	L/52	0/10	5907558434767
81-533-XL	XL/54	0/10	5907558434774
81-533-XXL	XXL/56	0/10	5907558434781



NEO  
TOOLS



NEO  
TOOLS



Ref.	Size	☒	EAN
81-530-S	S/48	0/20	5907558427011
81-530-M	M/50	0/20	5907558427028
81-530-L	L/52	0/20	5907558427035
81-530-XL	XL/56	0/20	5907558427042
81-530-XXL	XXL/58	0/20	5907558427059



NEO  
TOOLS

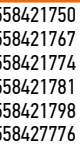
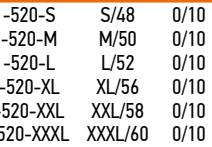

NEO  
TOOLS



Ref.	Size	☒	EAN
81-532-S	S/48	0/20	5907558427882
81-532-M	M/50	0/20	5907558427899
81-532-L	L/52	0/20	5907558427905
81-532-XL	XL/56	0/20	5907558427912
81-532-XXL	XXL/58	0/20	5907558427929
81-532-XXXL	XXXL/60	0/20	5907558427936



## Kamizelka robocza

Working vest / Arbeitsweste / Жилет рабочий / Жилетка робоча / Munkamellény / Vesta de lucru / Pracovní vesta / Pracovná vesta / Delovni brezrokavnik / Darbinė liemenė / Darba veste / Töövest / Работна жилетка / Radni prsluk / Radna košulja / Γιλέκο εργασίας / Chaleco de trabajo / Gilet da lavoro / Colete de trabalho / Gilet de travail



**NEO**  
TOOLS

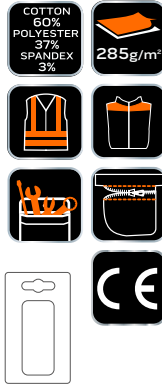

Ref.	Size	☒	EAN
81-268-S	S/48	0/10	5907558451931
81-268-M	M/50	0/10	5907558451948
81-268-L	L/52	0/10	5907558451955
81-268-XL	XL/54	0/10	5907558451962
81-268-XXL	XXL/56	0/10	5907558451979
81-268-XXXL	XXXL/58	0/10	5907558451986

**NEO**  
TOOLS



Ref.	Size	☒	EAN
81-260-S	S/48	0/10	5907558419320
81-260-M	M/50	0/10	5907558419320
81-260-L	L/52	0/10	5907558419344
81-260-XL	XL/56	0/10	5907558419351
81-260-XXL	XXL/58	0/10	5907558419368

## Koszula flanelowa

Flannel shirt / Flannelhemd / Фланелевая рубашка / Сорочка фланелева / Flanel ing / Cămașă de flanelă / Flanelová košile / Flanelová košela / Flanelasta srajica / Flaneliniai marškiniai / Flanelja kreklis / Flannelsärk / Фланелена риза / Košulja od flanela / Flanelska košulja / Φανελένιο πουκάμισο / Camisa de franela / Camicia di flanelia / Camisa de flanela / Chemise en flanelle

**NEO**  
TOOLS



Ref.	Size	☒	EAN
81-540-S	S/48	0/36	5907558432244
81-540-M	M/50	0/36	5907558432251
81-540-L	L/52	0/36	5907558432268
81-540-XL	XL/54	0/36	5907558432275
81-540-XXL	XXL/56	0/36	5907558432282



**NEO**  
TOOLS



Ref.	Size	☒	EAN
81-541-S	S/48	0/36	5907558432299
81-541-M	M/50	0/36	5907558432305
81-541-L	L/52	0/36	5907558432312
81-541-XL	XL/54	0/36	5907558432329
81-541-XXL	XXL/56	0/36	5907558432336



## Koszula robocza

Work shirt / Arbeitshemd / Рабочая рубашка / Рбоча сорочка / Munka ing / Cămașă de lucru / Pracovní košile / Pracovná košela / Delovna majica / Darbo marškiniai / Darba kreklis / Töösärk / Работна риза / Radna košulja / Радна мајица / εργασία πουκάμισο / Camisa de trabajo / Camicia da lavoro / Camisa de trabalho / Chemise de travail / Werk shirt

**NEO**  
TOOLS

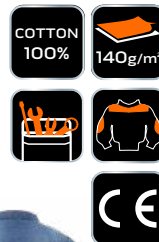

Ref.	Size	☒	EAN
81-549-S	S/48	0/30	5907558439625
81-549-M	M/50	0/30	5907558439632
81-549-L	L/52	0/30	5907558439649
81-549-XL	XL/54	0/30	5907558439656
81-549-XXL	XXL/56	0/30	5907558439663
81-549-XXXL	XXXL/58	0/30	5907558439670



## Koszulka termoaktywna

Thermal long sleeve / Thermo-Funktionsunterwäsche Hemd langarm / Термоактивная блуза / Футболка з довгим рукавом термоактивна / Thermo alöltözet felső / Cămașă termoactivă / Termoaktivni tričko / Termo tričko / Termo majica / Termo marškinėliai / Termoveļas kreklis / Termoaktiivne alussärk / Термоактивна блуза / Termoaktivna majica / Termoaktivna košulja / Λαοθερμική μπλούζα / Camiseta termoactiva / Maglia termica / Camisola térmica / Chemise thermoactive / Thermoactiveve shirt

**NEO**  
TOOLS

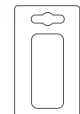

Ref.	Size	⊠	EAN
81-660-S/M	S/48 / M/50	0/60	5907558431964
81-660-L/XL	L/52 / XL/54	0/60	5907558431971
81-660-XXL/XXXL	XXL/56 / XXXL/58	0/60	5907558431988

**NEO**  
TOOLS

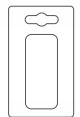

Ref.	Size	⊠	EAN
81-661-S/M	S/48 / M/50	0/50	5907558448900
81-661-L/XL	L/52 / XL/54	0/50	5907558448917
81-661-XXL/XXXL	XXL/56 / XXXL/58	0/50	5907558431971

**NEO**  
TOOLS

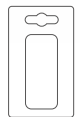

Ref.	Size	⊠	EAN
81-662-S/M	S/48 / M/50	0/60	5907558463392
81-662-L/XL	L/52 / XL/54	0/60	5907558463408
81-662-XXL/XXXL	XXL/56 / XXXL/58	0/60	5907558463415

**NEO**  
TOOLS

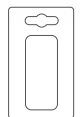

Ref.	Size	⊠	EAN
81-663-S/M	S/48 / M/50	0/60	5907558463422
81-663-L/XL	L/52 / XL/54	0/60	5907558463439
81-663-XXL/XXXL	XXL/56 / XXXL/58	0/60	5907558463446

## Kalesony termoaktywne

Thermal leggings / Thermo-Funktionsunterwäsche Hose / Термоактивные кальсоны / Кальсоны термоактивни / Thermo alöltözet alsó / Izmene thermoactive / Termoaktivni kalhoty (spodky) / Termo spodné nohavice / Termo spodnje hlače / Termo kelhēs / Termoveļas bikses / Termoaktiivsed pīkad aluspiiksid / Термоактивен клн / Termoaktivne duge gaće / Termoaktivne pantalone / Λαοθερμικό κολάν / Mallas termoactivas / Calzamaglia termica / Calças justas térmicas / Caleçon thermoactif / Thermoactiveve broek

**NEO**  
TOOLS

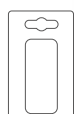

Ref.	Size	⊠	EAN
81-670-S/M	S/48 / M/50	0/60	5907558431995
81-670-L/XL	L/52 / XL/54	0/60	5907558432008
81-670-XXL/XXXL	XXL/56 / XXXL/58	0/60	5907558432015

**NEO**  
TOOLS

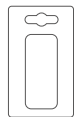

Ref.	Size	⊠	EAN
81-671-S/M	S/48 / M/50	0/50	5907558448931
81-671-L/XL	L/52 / XL/54	0/50	5907558448948
81-671-XXL/XXXL	XXL/56 / XXXL/58	0/50	5907558448955

**NEO**  
TOOLS

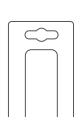

Ref.	Size	⊠	EAN
81-672-S/M	S/48 / M/50	0/60	5907558463453
81-672-L/XL	L/52 / XL/54	0/60	5907558463460
81-672-XXL/XXXL	XXL/56 / XXXL/58	0/60	5907558463477

**NEO**  
TOOLS

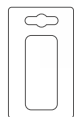
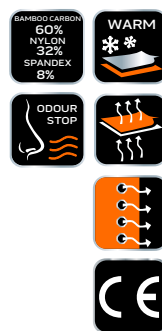

Ref.	Size	⊠	EAN
81-673-S/M	S/48 / M/50	0/60	5907558463484
81-673-L/XL	L/52 / XL/54	0/60	5907558463491
81-673-XXL/XXXL	XXL/56 / XXXL/58	0/60	5907558463507



## Czapka

Cap / Mütze / Шапка / Шапка / Sapka / Čaciulă / Čepice / Čiapka / Kapa / Kepurë / Müts / Шанка / Kapa / Kapa / Kapelo τύπου τζοκέυ / Gorra / Cappello / Gorro / Casquette / Muts

**NEO**  
TOOLS



**NEO**  
TOOLS



Ref.	Info	EAN
81-624	0/10	5907558450811



Ref.	Info	Info	EAN
81-622	320 g/m²	0/200	5907558428315
81-623	320 g/m², fleece	0/200	5907558428322

## Czapka z latarką

Cap with flashlight / Mütze mit Stirnlampe / Бейсболка с фонариком / Шапка з ліхтарем / Sapka lámpával / Čaciulă cu lanternă / Čepice s baterkou / Čiapka s baterkou / Kapa z lučko / Kepurë su žibintuveliu / Čepure ar luktur / Lambiga müt / Шапка с фенерче / Kapa sa svjetiljkom / Kapa s lampom / Kapelo τύπου τζοκέυ με φακό / Gorra con linterna / Cappello con torcia elettrica / Gorro con lanterna / Casquette avec torche

**NEO**  
TOOLS

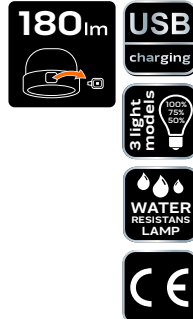

Ref.	Info	EAN
81-621	12/120	5907558428308

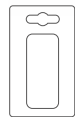

**NEO**  
TOOLS



81-632



81-631



81-630



Ref.	Info	EAN
81-630	0/100	5907558460179
81-631	0/100	5907558460186
81-632	0/100	5907558460193

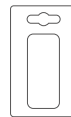

## Czapka z daszkiem

Work cap / Schildmütze / Бейсболка рабочая / Бейсболка рабочая / Láthatósági sapka / Sapka cu cozoroc / Pracovní kšiltovka / Čiapka so šiltom, pracovná / Delovna kapa s šiltom / Kepurë su snapelii / Darba cepure ar pagu / Nokaga töömüts / Рабочна шапка с козырка / Radna kapa / Radnička kapa / Kapelo εργασίας τύπου μπέιζμπολ / Gorra de trabajo / Cappello / Boné de trabalho / Casquette de travail à visière

**NEO**  
TOOLS

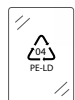

Ref.	Info	EAN
81-626	50/100	5907558442489

**NEO**  
TOOLS

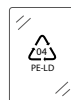

Ref.	Info	Info	EAN
81-793		25/100	5907558429909
81-794		25/100	5907558429916

**NEO**  
TOOLS



Ref.	Info	EAN
81-620	15/60	5907558407624

**NEO**  
TOOLS

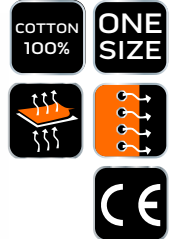

Ref.	Info	Info	EAN
81-625		25/100	5907558453669



## Komin

Tube scarf / Schlauchschal / Шарф-труба / Трубка шарф / Cső sál / Eşarfa de tub / Trubice šátek / Trubičkový sál / Cevni šal / Vamzdžio skara / Caurules šalle / Torusall / Τρῆβεν σαν / Cijevni šal / Тубе сан / Κασκόλ σωλήνα / Bufanda de tubo / Sciarpa a tubo / Lenço de tubo / Écharpe tube

**NEO**  
TOOLS

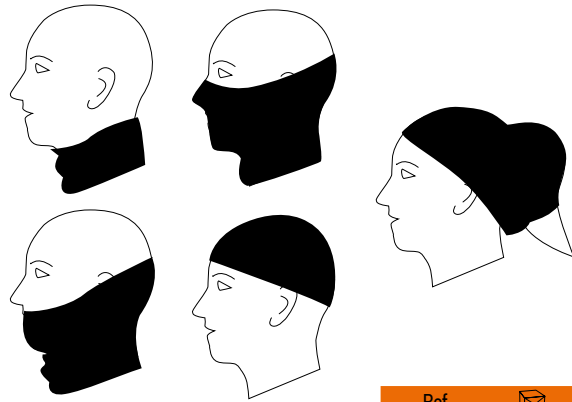

POLYESTER  
92%  
ELASTAN  
8%

ONE  
SIZE

5  
in 1

WARM

Ref. 81-628 EAN 5907558450828

## Póľbuty robocze

Safety shoes / Arbeitshalschuhe / Полуботинки рабочие / Півчеревики робочі / Munkcipő / Pantofi de lucru / Pracovní obuv / Pracovné poltopánky / Nizki delovni čevlji / Darbo pusbačiai / Darba puszabaki / Töökingad / Работни обувки ниски (половинни) / Radne cipele / Poluduboke radne cipele / Нїміпота ервасіас / Botas de seguridad / Scarpa da lavoro / Sapatos de trabalho / Souliers de sécurité / Werkschoenen



**NEO**  
TOOLS



Ref.	Size	Size [cm]	☒	EAN
82-530-36	36	24	0/10	5907558437393
82-530-37	37	24.7	0/10	5907558437409
82-530-38	38	25.3	0/10	5907558437416
82-530-39	39	26	0/10	5907558437423
82-530-40	40	26.7	0/10	5907558437430
82-530-41	41	27.3	0/10	5907558437447

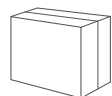

## Trzewiki robocze

Safety boots / Arbeitsschuhe / Ботинки рабочие / Черевинки робочі / Munkabakancs / Bocanci de lucru / Kotničková pracovní obuv / Pracovné topánky / Visoki delovni čevlji / Darbo batai / Darba zābaki / Töösaapad / Работни обувки високи / Radne visoke cipele / Radne cipele / Мпотаки ервасіас / Botas de seguridad altas / Scarpa alta da lavoro / Botas de trabalho / Chaussures de sécurité / Hoge werkschoenen



**NEO**  
TOOLS



Ref.	Size	Size [cm]	☒	EAN
82-540-36	36	24	0/10	5907558437454
82-540-37	37	24.7	0/10	5907558437461
82-540-38	38	25.3	0/10	5907558437478
82-540-39	39	26	0/10	5907558437485
82-540-40	40	26.7	0/10	5907558437492
82-540-41	41	27.3	0/10	5907558437508

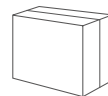

## Póľbuty robocze

Safety shoes / Arbeitshalschuhe / Полуботинки рабочие / Півчеревики робочі / Munkcipő / Pantofi de lucru / Pracovní obuv / Pracovné poltopánky / Nizki delovni čevlji / Darbo pusbačiai / Darba puszabaki / Töökingad / Работни обувки ниски (половинни) / Radne cipele / Poluduboke radne cipele / Нїміпота ервасіас / Botas de seguridad / Scarpa da lavoro / Sapatos de trabalho / Souliers de sécurité / Werkschoenen



**NEO**  
TOOLS



Ref.	Size	Size [cm]	☒	EAN
82-150-39	39	26	0/10	5907558438086
82-150-40	40	26.7	0/10	5907558438093
82-150-41	41	27.3	0/10	5907558438109
82-150-42	42	28	0/10	5907558438116
82-150-43	43	28.7	0/10	5907558438123
82-150-44	44	29.3	0/10	5907558438130
82-150-45	45	30	0/10	5907558438147
82-150-46	46	30.7	0/10	5907558438154
82-150-47	47	31.3	0/10	5907558438161

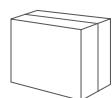

**NEO**  
TOOLS



Ref.	Size	Size [cm]	☒	EAN
82-159-39	39	26	0/10	5907558470062
82-159-40	40	26.7	0/10	5907558470079
82-159-41	41	27.3	0/10	5907558470086
82-159-42	42	28	0/10	5907558470093
82-159-43	43	28.7	0/10	5907558470109
82-159-44	44	29.3	0/10	5907558470116
82-159-45	45	30	0/10	5907558470123
82-159-46	46	30.7	0/10	5907558470130
82-159-47	47	31.3	0/10	5907558470147

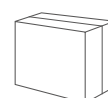

## Póľbuty robocze

Safety shoes / Arbeitshalschuhe / Пубуботинки робочие / Пивчеревици робочи / Мункасирб / Pantofi de lucru / Pracovni obuv / Pracovne poltoprany / Nizki delovni cjevli / Darbo pusbačiai / Darba puszabaki / Töökngad / Работни обувки ниски (половинки) / Radne cipele / Poluduboke radne cipele / Нийтмота еруагас / Botas de seguridad / Scarpa da lavoro / Sapatos de trabalho / Souliers de sécurité / Werkschoenen



Ref.	Size	Size [cm]	☒	EAN
82-156-36	36	24	0/10	5907558442991
82-156-37	37	24.7	0/10	5907558443004
82-156-38	38	25.3	0/10	5907558443011
82-156-39	39	26	0/10	5907558443028
82-156-40	40	26.7	0/10	5907558443301
82-156-41	41	27.3	0/10	5907558443318
82-156-42	42	28	0/10	5907558443325
82-156-43	43	28.7	0/10	5907558443332
82-156-44	44	29.3	0/10	5907558443349
82-156-45	45	30	0/10	5907558443356
82-156-46	46	30.7	0/10	5907558443363
82-156-47	47	31.3	0/10	5907558443370

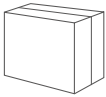

Ref.	Size	Size [cm]	☒	EAN
82-030	39	26	0/10	5907558415117
82-031	40	26.7	0/10	5907558415124
82-032	41	27.3	0/10	5907558415131
82-033	42	28	0/10	5907558415148
82-034	43	28.7	0/10	5907558415155
82-035	44	29.3	0/10	5907558415162
82-036	45	30	0/10	5907558415179
82-037	46	30.7	0/10	5907558415186
82-038	47	31.3	0/10	5907558421026

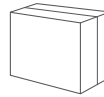

Ref.	Size	Size [cm]	☒	EAN
82-010	39	26	0/10	5907558412604
82-011	40	26.7	0/10	5907558414530
82-012	41	27.3	0/10	5907558414974
82-013	42	28	0/10	5907558414981
82-014	43	28.7	0/10	5907558414998
82-015	44	29.3	0/10	5907558415001
82-016	45	30	0/10	5907558415018
82-017	46	30.7	0/10	5907558415025
82-018	47	31.3	0/10	5907558421002

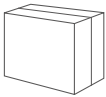

Ref.	Size	Size [cm]	☒	EAN
82-157-39	39	26	0/10	5907558453270
82-157-40	40	26.7	0/10	5907558453287
82-157-41	41	27.3	0/10	5907558453294
82-157-42	42	28	0/10	5907558453300
82-157-43	43	28.7	0/10	5907558453317
82-157-44	44	29.3	0/10	5907558453324
82-157-45	45	30	0/10	5907558453331
82-157-46	46	30.7	0/10	5907558453348
82-157-47	47	31.3	0/10	5907558453355

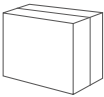

Ref.	Size	Size [cm]	☒	EAN
82-158-39	39	26	0/10	5907558465419
82-158-40	40	26.7	0/10	5907558465426
82-158-41	41	27.3	0/10	5907558465433
82-158-42	42	28	0/10	5907558465440
82-158-43	43	28.7	0/10	5907558465457
82-158-44	44	29.3	0/10	5907558465464
82-158-45	45	30	0/10	5907558465471
82-158-46	46	30.7	0/10	5907558465488
82-158-47	47	31.3	0/10	5907558465495

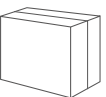

Ref.	Size	Size [cm]	☒	EAN
82-155-39	39	26	0/10	5907558442908
82-155-40	40	26.7	0/10	5907558442915
82-155-41	41	27.3	0/10	5907558442922
82-155-42	42	28	0/10	5907558442939
82-155-43	43	28.7	0/10	5907558442946
82-155-44	44	29.3	0/10	5907558442953
82-155-45	45	30	0/10	5907558442960
82-155-46	46	30.7	0/10	5907558442977
82-155-47	47	31.3	0/10	5907558442984

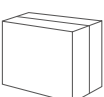



## Póľbuty robocze

Safety shoes / Arbeitshalschuhe / Полуботинки робочие / Півчеревики робочі / Мункасірб / Pantofi de lucru / Pracovní obuv / Pracovné poltopánky / Nizki delovni čevlji / Darbo pusbačiai / Darba puszabaki / Töökingad / Работни обувки ниски (половинки) / Radne cipele / Poluduboke radne cipele / Низи́нота ерваа́с / Botas de seguridad / Scarpa da lavoro / Sapatos de trabalho / Souliers de sécurité / Werkschoenen



NEO TOOLS



Ref.	Size	Size [cm]	☒	EAN
82-090	39	26	0/10	5907558426748
82-091	40	26.7	0/10	5907558426755
82-092	41	27.3	0/10	5907558426762
82-093	42	28	0/10	5907558426779
82-094	43	28.7	0/10	5907558426786
82-095	44	29.3	0/10	5907558426793
82-096	45	30	0/10	5907558426809
82-097	46	30.7	0/10	5907558426816
82-098	47	31.3	0/10	5907558426823

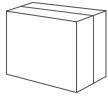

NEO TOOLS



Ref.	Size	Size [cm]	☒	EAN
82-100	39	26	0/10	5907558426830
82-101	40	26.7	0/10	5907558426847
82-102	41	27.3	0/10	5907558426854
82-103	42	28	0/10	5907558426861
82-104	43	28.7	0/10	5907558426878
82-105	44	29.3	0/10	5907558426885
82-106	45	30	0/10	5907558426892
82-107	46	30.7	0/10	5907558426908
82-108	47	31.3	0/10	5907558426915

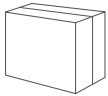

NEO TOOLS



Ref.	Size	Size [cm]	☒	EAN
82-160-39	39	26	0/10	5907558483970
82-160-40	40	26.7	0/10	5907558483987
82-160-41	41	27.3	0/10	5907558483994
82-160-42	42	28	0/10	5907558484007
82-160-43	43	28.7	0/10	5907558484014
82-160-44	44	29.3	0/10	5907558484021
82-160-45	45	30	0/10	5907558484038
82-160-46	46	30.7	0/10	5907558484045
82-160-47	47	31.3	0/10	5907558484052

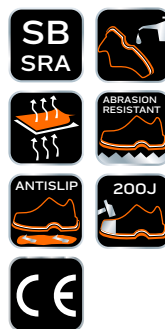
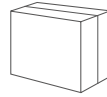

NEO TOOLS



Ref.	Size	Size [cm]	☒	EAN
82-110	39	26	0/10	5907558426922
82-111	40	26.7	0/10	5907558426939
82-112	41	27.3	0/10	5907558426946
82-113	42	28	0/10	5907558426953
82-114	43	28.7	0/10	5907558426960
82-115	44	29.3	0/10	5907558426977
82-116	45	30	0/10	5907558426984
82-117	46	30.7	0/10	5907558426991
82-118	47	31.3	0/10	5907558427004

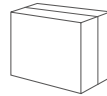

## Trzewiki robocze

Safety boots / Arbeitsschuhe / Ботинки робочие / Черевики робочі / Мункабаканс / Boscanci de lucru / Kotníková pracovní obuv / Pracovné topánky / Visoki delovni čevlji / Darbo batai / Darba zābaki / Töösaapad / Работни обувки високи / Radne visoke cipele / Radne cipele / Многа́нка ерваа́с / Botas de seguridad altas / Scarpa alta da lavoro / Botas de trabalho / Chaussures de sécurité / Hoge werkschoenen



NEO TOOLS



Ref.	Size	Size [cm]	☒	EAN
82-170-39	39	26	0/10	5907558483703
82-170-40	40	26.7	0/10	5907558483710
82-170-41	41	27.3	0/10	5907558483727
82-170-42	42	28	0/10	5907558483734
82-170-43	43	28.7	0/10	5907558483741
82-170-44	44	29.3	0/10	5907558483758
82-170-45	45	30	0/10	5907558483765
82-170-46	46	30.7	0/10	5907558483772
82-170-47	47	31.3	0/10	5907558483789

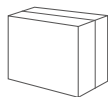

NEO TOOLS



Ref.	Size	Size [cm]	☒	EAN
82-175-39	39	26	0/10	5907558483796
82-175-40	40	26.7	0/10	5907558483802
82-175-41	41	27.3	0/10	5907558483819
82-175-42	42	28	0/10	5907558483826
82-175-43	43	28.7	0/10	5907558483833
82-175-44	44	29.3	0/10	5907558483840
82-175-45	45	30	0/10	5907558483857
82-175-46	46	30.7	0/10	5907558483864
82-175-47	47	31.3	0/10	5907558483871

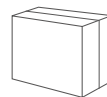

## Trzewiki robocze

Safety boots / Arbeitsschuhe / Ботинки рабочие / Черевяки робочі / Munkabakancs / Vocanci de lucru / Kotníková pracovní obuv / Pracovné topánky / Visoki delovni čevlji / Darbo batai / Darba zābaki / Töösaapad / Работну обувку високу / Radne visoke cipele / Radne cipele / Μπoτάκια εργαίας / Botas de seguridad altas / Scarpa alta da lavoro / Botas de trabalho / Chaussures de sécurité / Hoge werkschoenen



NEO TOOLS



Ref.	Size	Size [cm]	☒	EAN
82-120	39	26	0/10	5907558428698
82-121	40	26.7	0/10	5907558428704
82-122	41	27.3	0/10	5907558428711
82-123	42	28	0/10	5907558428728
82-124	43	28.7	0/10	5907558428735
82-125	44	29.3	0/10	5907558428742
82-126	45	30	0/10	5907558428759
82-127	46	30.7	0/10	5907558428766
82-128	47	31.3	0/10	5907558428773

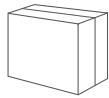

NEO TOOLS



Ref.	Size	Size [cm]	☒	EAN
82-151-39	39	26	0/10	5907558437997
82-151-40	40	26.7	0/10	5907558438000
82-151-41	41	27.3	0/10	5907558438017
82-151-42	42	28	0/10	5907558438024
82-151-43	43	28.7	0/10	5907558438031
82-151-44	44	29.3	0/10	5907558438048
82-151-45	45	30	0/10	5907558438055
82-151-46	46	30.7	0/10	5907558438062
82-151-47	47	31.3	0/10	5907558438079

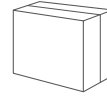

NEO TOOLS



Ref.	Size	Size [cm]	☒	EAN
82-166-39	39	26	0/10	5907558484151
82-166-40	40	26.7	0/10	5907558484168
82-166-41	41	27.3	0/10	5907558484175
82-166-42	42	28	0/10	5907558484182
82-166-43	43	28.7	0/10	5907558484199
82-166-44	44	29.3	0/10	5907558484205
82-166-45	45	30	0/10	5907558484212
82-166-46	46	30.7	0/10	5907558484229
82-166-47	47	31.3	0/10	5907558484236

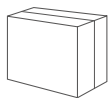

NEO TOOLS



Ref.	Size	Size [cm]	☒	EAN
82-040	39	26	0/10	5907558415193
82-041	40	26.7	0/10	5907558415209
82-042	41	27.3	0/10	5907558415216
82-043	42	28	0/10	5907558415223
82-044	43	28.7	0/10	5907558415230
82-045	44	29.3	0/10	5907558415247
82-046	45	30	0/10	5907558415254
82-047	46	30.7	0/10	5907558415261
82-048	47	31.3	0/10	5907558421033

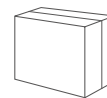

NEO TOOLS



Ref.	Size	Size [cm]	☒	EAN
82-020	39	26	0/10	5907558415032
82-021	40	26.7	0/10	5907558415049
82-022	41	27.3	0/10	5907558415056
82-023	42	28	0/10	5907558415063
82-024	43	28.7	0/10	5907558415070
82-025	44	29.3	0/10	5907558415087
82-026	45	30	0/10	5907558415094
82-027	46	30.7	0/10	5907558415100
82-028	47	31.3	0/10	5907558421019

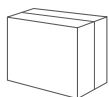

NEO TOOLS



Ref.	Size	Size [cm]	☒	EAN
82-140	39	26	0/10	5907558434446
82-141	40	26.7	0/10	5907558434453
82-142	41	27.3	0/10	5907558434460
82-143	42	28	0/10	5907558434477
82-144	43	28.7	0/10	5907558434484
82-145	44	29.3	0/10	5907558434491
82-146	45	30	0/10	5907558434507
82-147	46	30.7	0/10	5907558434514
82-148	47	31.3	0/10	5907558434521

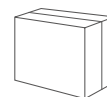

## Trzewiki robocze

Safety boots / Arbeitsschuhe / Ботинки рабочие / Черевини робочі / Munkabakancs / Boscanci de lucru / Kotlíková pracovná obuv / Pracovné topánky / Visoki delovni čevlji / Darbo batai / Darba zābaki / Töösaapad / Работни обувки високи / Radne visoke cipele / Radne cipele / Μητάκια εργασίας / Botas de seguridad altas / Scarpa alta da lavoro / Botas de trabalho / Chaussures de sécurité / Hoge werkschoenen

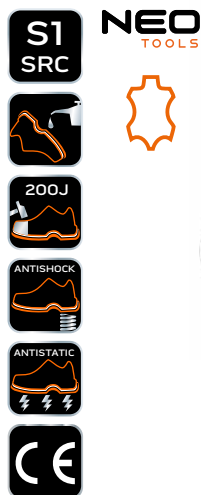

Ref.	Size	Size [cm]	☒	EAN
82-165-39	39	26	0/10	5907558484069
82-165-40	40	26.7	0/10	5907558484076
82-165-41	41	27.3	0/10	5907558484083
82-165-42	42	28	0/10	5907558484090
82-165-43	43	28.7	0/10	5907558484106
82-165-44	44	29.3	0/10	5907558484113
82-165-45	45	30	0/10	5907558484120
82-165-46	46	30.7	0/10	5907558484137
82-165-47	47	31.3	0/10	5907558484144

## Sandaly robocze

Working sandals / Arbeitssandale / Рабочие сандалы / Sandale de lucru / Робочі стандарти / Munkaszandál / Pracovní sandály / Pracovné sandále / Delovni sandali / Darbo sandalai / Darba sandales / Töösandaliid / Работни сандали / Radne sandale / Radne sandale / Σανδάλια εργασίας / Sandalias de trabajo / Sandali da lavoro / Sandálias de proteção / Sandales de travail / Werksandalen



Ref.	Size	Size [cm]	☒	EAN
82-079-39	39	26	0/10	5907558469974
82-079-40	40	26.7	0/10	5907558469981
82-079-41	41	27.3	0/10	5907558469998
82-079-42	42	28	0/10	5907558470000
82-079-43	43	28.7	0/10	5907558470017
82-079-44	44	29.3	0/10	5907558470024
82-079-45	45	30	0/10	5907558470031
82-079-46	46	30.7	0/10	5907558470048
82-079-47	47	31.3	0/10	5907558470055

## Sandaly robocze

Working sandals / Arbeitssandale / Рабочие сандалы / Sandale de lucru / Робочі стандарти / Munkaszandál / Pracovní sandály / Pracovné sandále / Delovni sandali / Darbo sandalai / Darba sandales / Töösandaliid / Работни сандали / Radne sandale / Radne sandale / Σανδάλια εργασίας / Sandalias de trabajo / Sandali da lavoro / Sandálias de proteção / Sandales de travail / Werksandalen



Ref.	Size	Size [cm]	☒	EAN
82-070-39	39	26	0/10	5907558440812
82-070-40	40	26.7	0/10	5907558440829
82-070-41	41	27.3	0/10	5907558440836
82-070-42	42	28	0/10	5907558440843
82-070-43	43	28.7	0/10	5907558440850
82-070-44	44	29.3	0/10	5907558440867
82-070-45	45	30	0/10	5907558440874
82-070-46	46	30.7	0/10	5907558440881
82-070-47	47	31.3	0/10	5907558440898



Ref.	Size	Size [cm]	☒	EAN
82-080-39	39	26	0/10	5907558440935
82-080-40	40	26.7	0/10	5907558440942
82-080-41	41	27.3	0/10	5907558440959
82-080-42	42	28	0/10	5907558440966
82-080-43	43	28.7	0/10	5907558440973
82-080-44	44	29.3	0/10	5907558440980
82-080-45	45	30	0/10	5907558440997
82-080-46	46	30.7	0/10	5907558441000
82-080-47	47	31.3	0/10	5907558441017

## Półbuty robocze

Safety shoes / Arbeitshalbschuhe / Полуботинки рабочие / Півчеревини робочі / Munkcipő / Pantafji de lucru / Pracovní obuv / Pracovné poltopánky / Nizki delovni čevlji / Darbo pusbačiai / Darba puszābaki / Töökingad / Работни обувки ниски (половинки) / Radne cipele / Poluduboke radne cipele / Нїжнїята ергасїас / Botas de seguridad / Scarpa da lavoro / Sapatos de trabalho / Souliers de sécurité / Werkschoenen



Ref.	Size	Size [cm]	☒	EAN
82-740-39	39	26	0/10	5907558437812
82-740-40	40	26.7	0/10	5907558437829
82-740-41	41	27.3	0/10	5907558437836
82-740-42	42	28	0/10	5907558437843
82-740-43	43	28.7	0/10	5907558437850
82-740-44	44	29.3	0/10	5907558437867
82-740-45	45	30	0/10	5907558437874
82-740-46	46	30.7	0/10	5907558437881
82-740-47	47	31.3	0/10	5907558437898



Ref.	Size	Size [cm]	☒	EAN
82-760-36	36	24	0/10	5907558437577
82-760-37	37	24.7	0/10	5907558437584
82-760-38	38	25.3	0/10	5907558437591
82-760-39	39	26	0/10	5907558437607
82-760-40	40	26.7	0/10	5907558437614
82-760-41	41	27.3	0/10	5907558437621
82-760-42	42	28	0/10	5907558437638
82-760-43	43	28.7	0/10	5907558437645
82-760-44	44	29.3	0/10	5907558437652
82-760-45	45	30	0/10	5907558437669
82-760-46	46	30.7	0/10	5907558437676
82-760-47	47	31.3	0/10	5907558437683



## Półbuty robocze

Safety shoes / Arbeitshabschuhe / Полуботинки рабочие / Півчеревики робочі / Munkacipő / Pantofi de lucru / Pracovní obuv / Pracovné poltopánky / Nizki delovni čevlji / Darbo pusbačiai / Darba puszabaki / Töökingad / Работни обувки ниски (половинки) / Radne cipele / Poluduboke radne cipele / Ημίμπατα εργασιές / Botas de seguridad / Scarpa da lavoro / Sapatos de trabalho / Souliers de sécurité / Werkschoenen



NEO TOOLS



Ref.	Size	Size [cm]	☒	EAN
82-700	39	26	0/10	5907558430073
82-701	40	26.7	0/10	5907558430080
82-702	41	27.3	0/10	5907558430097
82-703	42	28	0/10	5907558430103
82-704	43	28.7	0/10	5907558430110
82-705	44	29.3	0/10	5907558430127
82-706	45	30	0/10	5907558430134
82-707	46	30.7	0/10	5907558430141
82-708	47	31.3	0/10	5907558430158

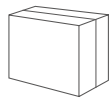

NEO TOOLS



Ref.	Size	Size [cm]	☒	EAN
82-730	39	26	0/10	5907558430639
82-731	40	26.7	0/10	5907558430646
82-732	41	27.3	0/10	5907558430653
82-733	42	28	0/10	5907558430660
82-734	43	28.7	0/10	5907558430677
82-735	44	29.3	0/10	5907558430684
82-736	45	30	0/10	5907558430691
82-737	46	30.7	0/10	5907558430707
82-738	47	31.3	0/10	5907558429213

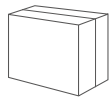

NEO TOOLS



Ref.	Size	Size [cm]	☒	EAN
82-710	39	26	0/10	5907558430165
82-711	40	26.7	0/10	5907558430172
82-712	41	27.3	0/10	5907558430189
82-713	42	28	0/10	5907558430196
82-714	43	28.7	0/10	5907558430202
82-715	44	29.3	0/10	5907558430219
82-716	45	30	0/10	5907558430226
82-717	46	30.7	0/10	5907558430233
82-718	47	31.3	0/10	5907558430240

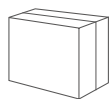

## Sandaly robocze

Working sandals / Arbeitssandale / Рабочие сандалы / Sandale de lucru / Робочі стандарти / Munkasandál / Pracovní sandály / Pracovné sandále / Delovni sandali / Darbo sandalai / Darba sandales / Töösandaalid / Работни сандалы / Radne sandale / Radne sandale / Σανδάλια εργασιές / Sandalias de trabajo / Sandali da lavoro / Sandálias de proteção / Sandales de travail / Werksandalen



NEO TOOLS



Ref.	Size	Size [cm]	☒	EAN
82-720	39	26	0/10	5907558430257
82-721	40	26.7	0/10	5907558430264
82-722	41	27.3	0/10	5907558430271
82-723	42	28	0/10	5907558430288
82-724	43	28.7	0/10	5907558430295
82-725	44	29.3	0/10	5907558430301
82-726	45	30	0/10	5907558430318
82-727	46	30.7	0/10	5907558430325
82-728	47	31.3	0/10	5907558430332

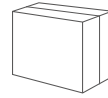

## Trzewiki robocze

Safety boots / Arbeitsschuhe / Ботинки рабочие / Черевики робочі / Munkabakancs / Bocanci de lucru / Kotníková pracovní obuv / Pracovné topánky / Visoki delovni čevlji / Darbo batai / Darba zăbaki / Töösaapad / Работни обувки високи / Radne visoke cipele / Radne cipele / Μηροτάκια εργασιές / Botas de seguridad altas / Scarpa alta da lavoro / Botas de trabalho / Chaussures de sécurité / Hoge werkschoenen



NEO TOOLS



Ref.	Size	Size [cm]	☒	EAN
82-750-39	39	26	0/10	5907558437904
82-750-40	40	26.7	0/10	5907558437911
82-750-41	41	27.3	0/10	5907558437928
82-750-42	42	28	0/10	5907558437935
82-750-43	43	28.7	0/10	5907558437942
82-750-44	44	29.3	0/10	5907558437959
82-750-45	45	30	0/10	5907558437966
82-750-46	46	30.7	0/10	5907558437973
82-750-47	47	31.3	0/10	5907558437980

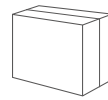

NEO TOOLS



Ref.	Size	Size [cm]	☒	EAN
82-770-36	36	24	0/10	5907558437690
82-770-37	37	24.7	0/10	5907558437706
82-770-38	38	25.3	0/10	5907558437713
82-770-39	39	26	0/10	5907558437720
82-770-40	40	26.7	0/10	5907558437737
82-770-41	41	27.3	0/10	5907558437744
82-770-42	42	28	0/10	5907558437751
82-770-43	43	28.7	0/10	5907558437768
82-770-44	44	29.3	0/10	5907558437775
82-770-45	45	30	0/10	5907558437782
82-770-46	46	30.7	0/10	5907558437799
82-770-47	47	31.3	0/10	5907558437805

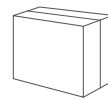

## Kalosze

Rubber boots / Gummistiefel / Γαλοσι / Чоботу / Gumicsizma / Cizme cauciuc / Holinky / Gumáky / Galoše / Guminniai batai / Galošas / Kummikud / Gumene čizme / čizme za kišu / Уелунатоу / Γαλότες / Stivali in gomma / Botas de agua / Botas de chuva / Bottes en caoutchouc / Regenlaarzen /

**NEO**  
TOOLS



Ref.	Size	Size [cm]	☒	EAN
82-900-40	40	26.7	0/6	5907558485745
82-900-41	41	27.3	0/6	5907558485752
82-900-42	42	28	0/6	5907558485769
82-900-43	43	28.7	0/6	5907558485776
82-900-44	44	29.3	0/6	5907558485783
82-900-45	45	30	0/6	5907558485790
82-900-46	46	30.7	0/6	5907558485806
82-900-47	47	31.3	0/6	5907558485813

**NEO**  
TOOLS



Ref.	Size	Size [cm]	☒	EAN
82-901-40	40	26.7	0/5	5907558485820
82-901-41	41	27.3	0/5	5907558485837
82-901-42	42	28	0/5	5907558485844
82-901-43	43	28.7	0/5	5907558485851
82-901-44	44	29.3	0/5	5907558485868
82-901-45	45	30	0/5	5907558485875
82-901-46	46	30.7	0/5	5907558485882

## Śniegowce

Snow boots / Schneestiefel / Зимние сапоги / Снігові чоботу / Нόταπόσό / Βοτσάνι de zapada / Boty do sněhu / Topánky do snehu / Snež škornji / Sniego batai / Sniega zábaki / Lumesaapad / Обувки за снег / Čizme za snijeg / Чизме за снег / Μπότες χιονοί / Botas de nieve / Scarponcini anti neve / Snow Botas / Bottes de neige / Sneeuwlaarzen



**NEO**  
TOOLS



Ref.	Size	Size [cm]	☒	EAN
82-131	40	26.3	0/10	5907558428483
82-132	41	26.9	0/10	5907558428421
82-133	42	27.6	0/10	5907558428438
82-134	43	28.3	0/10	5907558428445
82-135	44	28.9	0/10	5907558428452
82-136	45	29.6	0/10	5907558428469
82-137	46	30.3	0/10	5907558428476

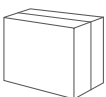

## Skarpety robocze

Working socks / Arbeitssocke / Рабочие носки / Шкарпетка робоча / Munkazokni / Šošetá de lucru / Pracovní ponožka / Pracovné ponožky / Delovna nogavica / Darbinės kojines / Darba zeķes basic / Töösokid / Рабочие чоран / Radne čarape / Radna čarapa / Κάλτα εργαίας / Calzetin de trabajo / Calza da lavoro / Meias de trabalho / Chaussette de travail / Werksok

**NEO TOOLS**

COTTON 67%  
POLYESTER 30%  
ELASTAN 3%

SOFT



OEKO-TEX®  
STANDARD 100  
FW 0004 IW  
Zašláhe na oděvním štítku  
www.oeko-tex.com

**NEO TOOLS**

COTTON 67%  
POLYESTER 30%  
ELASTAN 3%

SOFT



OEKO-TEX®  
STANDARD 100  
FW 0004 IW  
Zašláhe na oděvním štítku  
www.oeko-tex.com

**NEO TOOLS**

COTTON 67%  
POLYESTER 30%  
ELASTAN 3%

SOFT



OEKO-TEX®  
STANDARD 100  
FW 0004 IW  
Zašláhe na oděvním štítku  
www.oeko-tex.com

**NEO TOOLS**

COTTON 45%  
COOLMAX 23%  
POLYESTER 22%  
POLYAMID 6%  
SPANDEX 4%

ODOUR STOP

SOFT



OEKO-TEX®  
STANDARD 100  
FW 0004 IW  
Zašláhe na oděvním štítku  
www.oeko-tex.com

Ref.	Size	⊠	EAN
82-350	39 - 42	1/60	5907558444605
82-351	43 - 46	1/60	5907558444612

Ref.	Size	⊠	EAN
82-355	39 - 42	1/60	5907558444629
82-356	43 - 46	1/60	5907558444636

Ref.	Size	⊠	EAN
82-360	39 - 42	0/20	5907558444643
82-361	43 - 46	0/20	5907558444650

Ref.	Size	⊠	EAN
82-365	39 - 42	0/20	5907558463576
82-366	43 - 46	0/20	5907558463583

## Wkładka do butów

Shoe insert / Einlegesohle / Стелька для обуви / Устілка до черевуки / Talpbatét / Branté de încălțăminte / Vložka do obuvi / Vložka do topánok / Vložek za čevlje / Batų vidpadis / Aravu ieliktnis / Sisetalad / Вложка за обувки / Uložak za cipele / Uložak za obući / Πλάτος παπουτσιών / Plantilla para zapatos / Soletta per scarpe / Palmilha / Insert de chaussure / Inlegzool

**NEO TOOLS**



ANTISEPTIC

SOFT

ODOUR STOP

Ref.	Info	⊠	EAN
82-300	1 pcs	0/300	5907558431438

**NEO TOOLS**

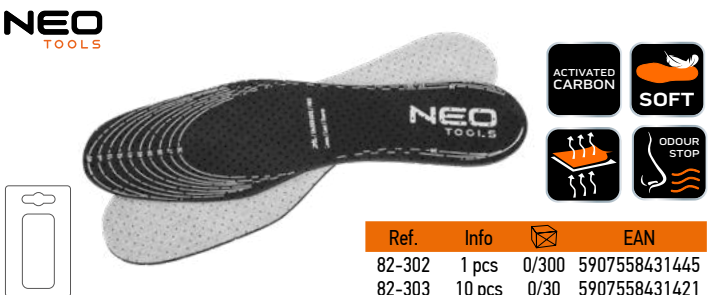

ACTIVATED CARBON

SOFT

ODOUR STOP

Ref.	Info	⊠	EAN
82-302	1 pcs	0/300	5907558431445
82-303	10 pcs	0/30	5907558431421

**NEO TOOLS**



WARM

SOFT

Ref.	Size	⊠	EAN
82-310	38-39	0/200	5907558430523
82-311	40-41	0/200	5907558430530
82-312	42-43	0/200	5907558430547
82-313	44-45	0/200	5907558430554
82-314	46-47	0/200	5907558430561

**NEO TOOLS**

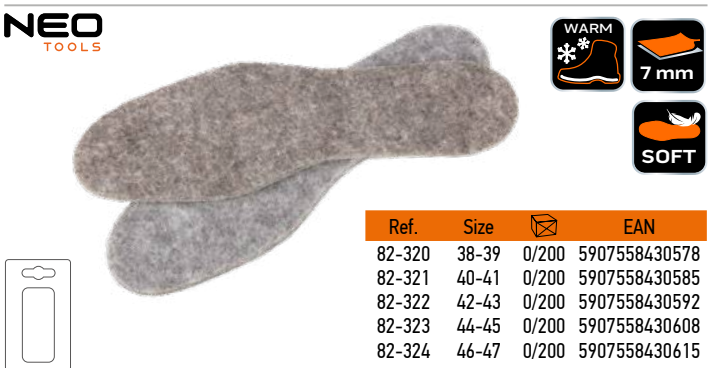

WARM

7 mm

SOFT

Ref.	Size	⊠	EAN
82-320	38-39	0/200	5907558430578
82-321	40-41	0/200	5907558430585
82-322	42-43	0/200	5907558430592
82-323	44-45	0/200	5907558430608
82-324	46-47	0/200	5907558430615

## Półmaska silikonowa

Silicon mask / Silikon-Halbmaske / Силиконова полумаска / Πίωμα σιλικόνα / Szilikon félmaszk / Semimasca cu silicon / Silikonová polomaska / Silikonový respirátor / Silikoniska polmaska / Silikoninė puskauke / Silikona pusmaska / Silikonist respirator / Силиконова полумаска / Silikoniska polumaska / Silikoniska polmaska / Μάσκα μισού προσώπου από σιλικόνη / Media máscara de silicona / Maschera di protezione / Semi-máscara em silicone / Demi-masque silicone

**NEO TOOLS**



CE

Ref.	⊠	EAN
97-350	0/60	5907558407730

## Pochłaniacz

Cartridge / Maskenfilter / Фильтрующий патрон A1 / Фільтр / Szűrő / Absorbant / Pohlcovač / Pohlcovač / Absorbent / Filtras / Absorbētājs / Filter / Adsorber / Apsorber / Prigušivač / Αναλκτακτικό φίλτρο A1 / Filtro / Cartuccia / Filtro / Absorbeur

**NEO TOOLS**



A1 NR for 97-350

CE

Ref.	⊠	EAN
97-360	50/200	5907558407747

**NEO TOOLS**



ABEK1 NR for 97-350

CE

Ref.	⊠	EAN
97-362	50/200	5907558409130

## Filtr

Filter / Filter / Фільтр / Фільтр / Szűrő / Filtru / Filtr / Filter / Filter / Filtras / Filtras / Filter / Филтър / Filter / Filtri za prašinu / Φίλτρο / Filtro / Filtro per mascherina / Filtro / Filtre / Filter

**NEO TOOLS**



P3 R for 97-350

CE

Ref.	⊠	EAN
97-361	50/200	5907558408058



## Półmaska przeciwyłowa

Dust half-mask / Staubschutzmaske / Респиратор противопылевой / Респиратор захисний протипилевої / Pormaszk / Mască mică protecție praf / Polomaska protiprašná / Respirátor protiprachový / Zaščitna maska / Puskauke nuo dulkių / Aizsargmaska / Tolmuvastane poolmask / Маска противопылевого / Zaštitna maska / Zaštitna maska / Ημιμασκα προσώπου / προστασίας από σκόνη / Máscara para polvo / Semimaschera contro polvere / Máscara contra pó / Demi-masque anti-poussière / Stof half-masker

**NEO**  
TOOLS

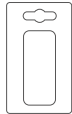

Ref.	Info	☒	EAN
97-336	x5	0/144	5907558455175
97-336-20	x20	0/54	5907558455182

**NEO**  
TOOLS



Ref.	Info	☒	EAN
97-337	x5	0/144	5907558455199
97-337-20	x20	0/54	5907558455205

**NEO**  
TOOLS

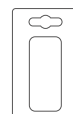

Ref.	Info	☒	EAN
97-338	x5	0/80	5907558455212
97-338-20	x20	0/18	5907558455229

**NEO**  
TOOLS

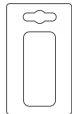

Ref.	☒	EAN
97-300	10/120	5907558407686

**NEO**  
TOOLS

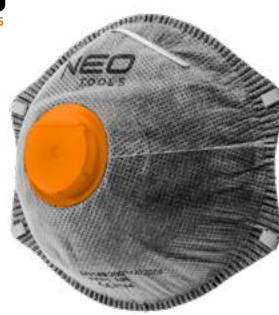

Ref.	☒	EAN
97-301	10/120	5907558407693

**NEO**  
TOOLS

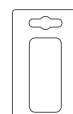

Ref.	☒	EAN
97-311	10/100	5907558407723

**NEO**  
TOOLS

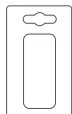

Ref.	☒	EAN
97-321	10/80	5907558421811

**T TOPEX**

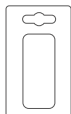

Ref.	☒	EAN
82S131	10/120	5902062821317

**T TOPEX**

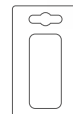

Ref.	☒	EAN
82S132	20/120	5902062821324

**T TOPEX**

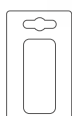

Ref.	☒	EAN
82S133	20/80	5902062200143

**T TOPEX**

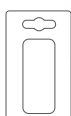

Ref.	☒	EAN
82S137	0/100	5902062994165

**T TOPEX**

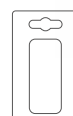

Ref.	☒	EAN
82S138	0/100	5902062994189



## Okulary ochrone

Safety goggles / Schutzbrille / Очки защитные / Окуляри протиоскопні / Védőszemüveg / Ochelari protecție / Ochranné brýle / Ochranné okuliare / Zaščitna očala / Apsauginiai akiniai / Aizsargbrilles / Kaitseprillid / Очла предпазни / Zaštitne naočale / Zastitne naočari / Γαυλιά προστασίας / Gafas protectoras / Occhiali di sicurezza / Óculos de proteção / Lunettes de protection / Beschermingsbril

**NEO**  
TOOLS



Ref. 97-505 EAN 5907558483147



Ref. 97-506 EAN 5907558483154



Ref. 97-507 EAN 5907558483161

**NEO**  
TOOLS



Ref. 97-508 EAN 50/200 5907558443806

**NEO**  
TOOLS



Ref. 97-502 EAN 50/200 5907558443776

**NEO**  
TOOLS



Ref. 97-503 EAN 12/120 5907558443783

**NEO**  
TOOLS



Ref. 97-504 EAN 12/120 5907558443790

**NEO**  
TOOLS



Ref. 97-500 EAN 6/72 5907558406887

**NEO**  
TOOLS



Ref. 97-501 EAN 6/72 5907558406894

**NEO**  
TOOLS



Ref. 97-510 EAN 12/300 5907558443820

**TOP TOOLS**



Ref. 82S101 EAN 20/200 5902062821010

## Gogle spawalnicze

Welding goggles / Augenschutzbrillen für Schweißer / Сварочные очки / Окуляри зварника / Hegesztőszemüveg / Ochelari de sudor / Svářečské brýle / Zváračské okuliare / Očala za varjenje / Akiniai suvirintojams / Metināšanas brilles / Kevitusprillid / Очла за заваряване / gogle za zavaranje / Naočare za varjenje / Γαυλιά ασφαλείας για συγκόλληση / Gafas de soldador / Occhiali per saldatura / Óculos de proteção para soldar / Lunettes google de soudure / Lasbril

**TOPEX**



Ref. 82S105 EAN 12/120 5902062208682





## Gogle ochrone

Protective goggles / Augenschutzbrillen / Защитные очки / Окуляри захисні / Védőszemüveg / Ochelari de protecție / Ochranné brýle / Ochranné okuliare / Zaščitna očala / Apsauginiai akiniai / Aizsargbrilles / Kaitseprillid / Защитни очила / Zaštitne gogle / Zaštitne naočare / Προστατευτικά γυαλιά / Gafas protectoras / Occhiali protettivi / Óculos de proteção / Lunettes google de protection / Veiligheidsbril

**NEO**  
TOOLS



chemical  
PROOF

BI120  
m/s

optical  
class 1

CE

Ref. 97-512    20/120    EAN 5907558443837



**NEO**  
TOOLS



ANTI  
FOG

optical  
class 1

BI120  
m/s

CE

Ref. 97-513    10/60    EAN 5907558443752



**NEO**  
TOOLS



optical  
class 1

BI120  
m/s

CE

Ref. 97-511    10/100    EAN 5907558443769



**NEO**  
TOOLS



ANTI  
FOG

BI120  
m/s

optical  
class 1

CE

Ref. 97-514    0/100    EAN 5907558472080

**TOP TOOLS**



CE

Ref. 82S102    0/100    EAN 5902062821027

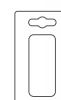

## Kask ochronny

Safety helmet / Schutzhelm / Каска защитная / Каска захисна / Védősisak / Cască protecție / Ochranná prilba / Bezpečnostná helma / Zaščitna čelada / Apsauginis šalmas / Aizsargķivere / Kaitsekiiver / Каска / Kaciga / Κράνος προστατευτικό / Casco de protección, amarillo / Caschetto / Capacete de protecção / Casque de protection / Veiligheidshelm

**NEO**  
TOOLS

Class 0

54-61  
cm

CE  
0161



Ref.	Color	QTY	EAN
97-200	Yellow	35/105	5907558467345
97-201	White	35/105	5907558467352
97-202	Blue	35/105	5907558467369
97-203	Green	35/105	5907558467376
97-204	Red	35/105	5907558467383
97-205	Orange	35/105	5907558467390

**NEO**  
TOOLS

ABS

52-64  
cm

CE  
2797



Ref.	Color	QTY	EAN
97-220	Yellow	0/25	5907558485936
97-221	White	0/25	5907558485943
97-222	Blue	0/25	5907558485950
97-223	Green	0/25	5907558485967
97-224	Red	0/25	5907558485974
97-225	Orange	0/25	5907558485981

**NEO**  
TOOLS

ABS

51-63  
cm

CE  
0161



Ref.	Color	QTY	EAN
97-210	Yellow	0/15	5907558483635
97-211	White	0/15	5907558483642



## Czapka z daszkami

Work cap / Schildmütze / Βεϊσβολκα работча / Βεϊσβολκα робоча / Láthatósági sapka / Sapca cuazoroc / Pracovní kšiltovka / Čiapka so šiltom, pracovná / Delovna kapa s šiltom / Kepure su snapelu / Darba cepure ar pagu / Nokaga töömüts / Работна шапка с нозирка / Radna kapa / Radnička kapa / Καπέλο εργασίας τύπου μπέιζμπολ / Gorra de trabajo / Cappello / Boné de trabalho / Casquette de travail à visière

NEO  
TOOLS



100%  
COTTON



Ref. EAN  
97-590 0/50 5907558415728

## Zestaw asekuracyjny z pasem biodrowym i amortyzatorem

Fall protection kit with a hip belt and shock absorber / Sicherheitsausrüstung Set mit Beckengurt und Stoßdämpfer / Страховочный комплект с поясным ремнем и амортизатором / Захисний захіб з поясним ременем / Biztosítókötél-készlet amortizátorral és derékövvel / Set de protecție cu centură de solduri și amortizor de șocuri / Bezpečnostní postrój s bederním pásem a tlumičem / Bezpečnostný postrój s bedrovým pásom a tlmičom / Varovalni komplet s trebušnim pasov, vzmeten / Saugos rinkinys su klubo diržu ir amortizatoriumi / Kritiena aizsardzības komplekts ar gurnu jostu un amortizatoru / Turvakomplekt puusavõõ ja amortisaatoriga / Комплект за безопасност с бедрен колан и амортисьор / Asekuracijski set z pojansom za kukove i amortizerom / Asekuracijski set sa pojansom za kukove i amortizerom / Σετ προστασίας από πτώση με ζώνη ισχίου και αμορτισέρ / Kit de arnés de seguridad con cinturón subabdominal y amortiguador / Kit anticaduta con imbracatura e ammortizzatore / Kit de arnés de segurança com cinto subabdominal e amortecedor / Kit de protection avec une ceinture de hanche et un amortisseur / Zekeringsset met heupgordel en demper

NEO  
TOOLS

PROUDLY  
MADE IN  
POLAND

•HARNES  
•2M SAFETY  
LINE  
•BAG

WITH  
SHOCK  
ABSORBER

UNIVERSAL  
SIZE  
M-XL



Ref. EAN  
97-102 0/12 5907558481693

## Zestaw asekuracyjny bez amortyzatora

Fall protection kit without shock absorber / Sicherheitsausrüstung Set ohne Stoßdämpfer / Страховочный комплект без амортизатора / Захисний захіб без амортизатора / Biztosítókötél-készlet amortizátor nélkül / Set de protecție fără amortizor de șocuri / Bezpečnostní postrój bez tlumiče / Bezpečnostný postrój bez tlmiča / Varovalni komplet, brez vzmetenja / Saugos rinkinys be amortizatoriaus / Kritiena aizsardzības komplekts bez amortizatora / Turvakomplekt ilma amortisaatorita / Комплект за безопасност без амортисьор / Asekuracijski set bez amortizera / Asekuracijski set bez amortizera / Σετ προστασίας από πτώση χωρίς αμορτισέρ / Kit de arnés de seguridad sin amortiguador / Kit anticaduta senza ammortizzatore / Kit de arnés de segurança sem amortecedor / Kit de protection sans amortisseur / Zekeringsset zonder demper

NEO  
TOOLS

PROUDLY  
MADE IN  
POLAND

•HARNES  
•2M SAFETY  
LINE  
•BAG

UNIVERSAL  
SIZE  
M-XL



Ref. EAN  
97-100 0/15 5907558481679

## Zestaw asekuracyjny z amortyzatorem

Fall protection kit with shock absorber / Sicherheitsausrüstung Set mit Stoßdämpfer / Страховочный комплект с амортизатором / Захисний захіб з амортизатором / Biztosítókötél-készlet amortizátorral / Set de protecție cu amortizor de șocuri / Bezpečnostní postrój s tlumičem / Bezpečnostný postrój s tlmičom / Varovalni komplet, vzmeten / Saugos rinkinys su amortizatoriumi / Kritiena aizsardzības komplekts ar amortizatoru / Turvakomplekt amortisaatoriga / Комплект за безопасност с амортисьор / Asekuracijski set s amortizerom / Asekuracijski set sa amortizerom / Σετ προστασίας από πτώση με αμορτισέρ / Kit de arnés de seguridad con amortiguador / Kit anticaduta con ammortizzatore / Kit de arnés de segurança com amortecedor / Kit de protection avec amortisseur / Zekeringsset met demper

NEO  
TOOLS

PROUDLY  
MADE IN  
POLAND

WITH  
SHOCK  
ABSORBER

•HARNES  
•2M SAFETY  
LINE  
•BAG

Up to  
100kg

UNIVERSAL  
SIZE  
M-XL

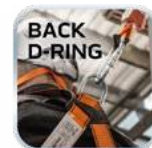

Ref. EAN  
97-101 0/15 5907558481686



## Nauszniki przeciwhałasowe

Earmuff / Gehörschutz / Наушники противошумные / Наушники захисні / Fültok / Placă de închidere ureche / Chráníče uší proti hluku / Chráníče sluchu / Štitniki za ušesa / Ausines / Klusinājāji-austīņas / Kõrvaklapid / Антшфон / Štitnik za uši-slušalice / Štitnik za uši / Αντιβουβικά καλλύματα αυτιών / Orejeras de protección auditiva / Cuffia di protezione / Protetores de orelhas contra barulho / Protège-oreilles anti-bruit / Lawaai gehoorbeschermers

**NEO**  
TOOLS



**SNR**  
27dB

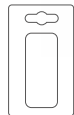

Ref. 97-560    Info 0/50    EAN 5907558443721

**NEO**  
TOOLS



**SNR**  
25dB

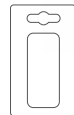

Ref. 97-561    Info 0/50    EAN 5907558443738

**NEO**  
TOOLS



**SNR**  
24dB

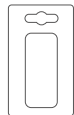

Ref. 97-562    Info 0/50    EAN 5907558443745

**NEO**  
TOOLS



**SNR**  
36dB

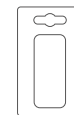

Ref. 97-565    Info 0/30    EAN 5907558466300

**NEO**  
TOOLS



**SNR**  
30dB

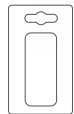

Ref. 97-563    Info 0/25    EAN 5907558453263

**NEO**  
TOOLS



**SNR**  
32dB

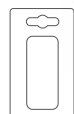

Ref. 97-564    Info 0/25    EAN 5907558466294

**NEO**  
TOOLS



COMPATIBLE WITH  
**NEO**  
TOOLS  
HELMETS

**SNR**  
29dB

Ref. 97-567    Info 0/50    EAN 5907558485998

## Wkładki przeciwhałasowe

Earplugs / Ohrstöpsel / Противошумные вкладыши / Бөрүкә ("бөрүкә") / Földugó pár / Antifoane / zátky do uší / Zátkové chráníče sluchu / Čepki za ušesa / Ausy kaištukai / Ausu aizbāžņi / Kõrvatropid / Антшфони, поставяни на ушете / Čepiči za uši / Čepovi za uši / Ωτασπιδες / Tapones para los oídos / Tappi per le orecchie / Tampões de ouvidos / Bouchons d'oreille / Oordopjes

**NEO**  
TOOLS

**x10** EN352

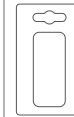

Ref.	Size	Info	Info	EAN
97-550	9/11	33dB	25/500	5907558419634

**NEO**  
TOOLS

**x10** EN352

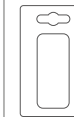

Ref.	Size	Info	Info	EAN
97-555	5/16	29dB	40/800	5907558419641

**NEO**  
TOOLS

**x1000** (500 pairs) **38** dB EN352



Ref.	Info	Info	EAN
97-552	38dB	0/20	5907558481648

**NEO**  
TOOLS

**38** dB **x1000** (500 pairs) EN352



Ref.	Info	Info	EAN
97-551	38dB	0/4	5907558481631



## Wkładki przeciwhałasowe

Earplugs / Ohrstöpsel / Противошумные вкладыши / Бөрүкә ("берүш") / Földugó pár / Antifoane / zátky do uší / Zátkové chrániče sluchu / Čepki za ušesa / Ausų kaištukai / Ausu aizbāžņi / Kõvatropid / Антифони, поставяни на ушите / Čepiči za uši / Čepovi za uši / Προσπίδες / Tapones para los oídos / Tappi per le orecchie / Tampões de ouvidos / Bouchons d'oreille / Oordopjes

**NEO**  
TOOLS

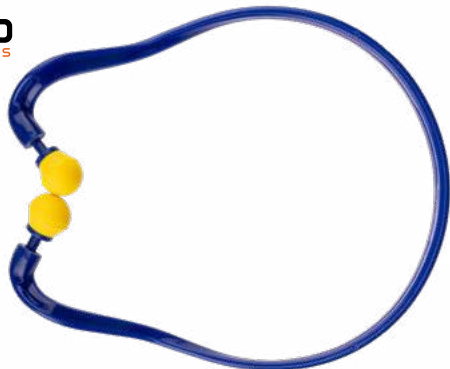

**29**  
dB

EN352

Ref. Info EAN  
97-553 29dB 15/300 5907558481655

**NEO**  
TOOLS



**32**  
dB

EN352

Ref. Info EAN  
97-554 29dB 30/600 5907558481662

## Nakolanniki ochrone

Knee protector / Knieschützer / Наколенники защитные / Щитки наколінні захисні / Térvédő zselés / Genunchiërä protectoare / Nákolenky / Chránič kolien / Ščitniki za kolena / Apsauga keliams / Ceļgalu aizsargi / Pāļvekaitse / Наколенки / Štitnik za koljena / Štitnik za kolena / Επιγονατίδες προστατευτικές / Rodilleras de protecció / Ginocchiere / Protecção de joelhos / Protège-genoux / Kniebescherming

**NEO**  
TOOLS



**x2**

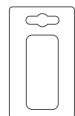

Ref. EAN  
97-536 6/24 5907558407679

**NEO**  
TOOLS



**x2**

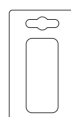

Ref. EAN  
97-535 6/24 5907558419627

**NEO**  
TOOLS



**TPR**

**x2**

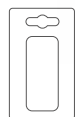

Ref. EAN  
97-537 6/12 5907558453645

**NEO**  
TOOLS



**x2**

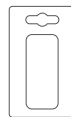

Ref. EAN  
97-538 6/24 5907558453652

**T TOPEX**

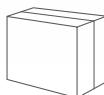

Ref. EAN  
82S162 0/10 5902062821621

**T TOPEX**

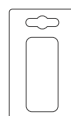

Ref. EAN  
82S160 0/20 5902062208248

**TOP TOOLS**

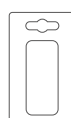

Ref. EAN  
82S161 9/36 5902062821614



## Wkładki piankowe na kolana

Knee foam pads / Knieeinlagen aus Schaumstoff / Вставки-наколенники из пеноматериала / Наколінники поліуретанові / Térdelő betét / Insertii de spuma pentru genunchi / Pěnové vložky kolen / Penové vložky na kolená / Penasti ščitniki za kolena / Apsauga keliams su putų pagalvėlimis / Putuplasta ieliktni celgaliam / Vahiplastist põlvekaitismed / Наколенники от пены / Pjenasti štitnik za koljeno / Jastučici od pene za kolena / Προσθαφαρισμένες επιγονατίδες από αφρώδες υλικό / Rodilleras de espuma / Ginocchiere / Almofada de espuma para joelho / Inserts de protection en mousse pour genoux / Schuimkniebescherming

NEO  
TOOLS

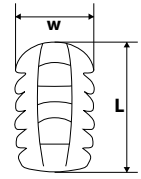

x2

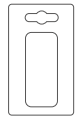

Ref.	W [mm]	L [mm]	☒	EAN
97-530	175	265	0/25	5907558419610

## Oszona przeciwdpryskowa

Face protection shield / Splitterschutz / Щиток противоосколочный / Щиток протиосколочный / Arcvédő / Ecran protecție față / Clona proti odpryskům / Ochranný štít / Štitnik za obraz / Apsauginis skydelis veidui / Pretlauskų aizsargmaska / Kaitsevisiir / Предназ. щит / Štitnik za lice / Štitnik za lice / Μάσκα κεφαλής προστασίας από θραύσματα / Mascara protectora facial / Visiera ribaltabile anti scheggia / Protecção / Protecteur anti-éclats / Bescherming tegen tegen slingerende deeltjes

NEO  
TOOLS



Ref.	☒	EAN
97-391	0/20	5907558468960

NEO  
TOOLS



Ref.	☒	EAN
97-392	0/40	5907558472073

TOPEX

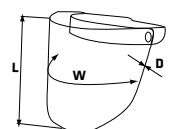

Ref.	L [mm]	W [mm]	D [mm]	☒	EAN
82S220	190	345	1	0/50	5902062994356

## Przyłbica spawalnicza

Welder's helmet / Schweißerschutzhelm / Шлем сварочный / Наска зварювальника / Hegesztősisak automatikus / Cască de sudor / Svářečská maska / Zváračská helma / Celada za varilca / Suvirintojo šalmas / Metinätāja maska / Keevituskiiver / Маска за електроужен / Maska za varioce / Maska za varioce / Κρανίο οξυγονοκολλητή / Mascara de soldadura con visera / Visiera per saldatura / Capacete de soldador / Casque de soudeur / Lashelm

GRAPHITE



DIN9-13



DIN11

MMA

MIG

MAG/CO<sup>2</sup>

TIG

PLASMA

EN379

Ref.	☒	EAN
56H820	0/1	5902062006974
56H822	0/1	5902062006981

## Oszona przeciwdpryskowa

Protection shield / Splitterschutz / Щиток противоосколочный / Щиток протиосколочный / Arcvédő / Ecran protecție / Clona proti odpryskům / Ochranný štít / Štitnik za obraz / Apsauginis skydelis veidui / Pretlauskų aizsargmaska / Kaitsevisiir / Предназ. щит / Štitnik za lice / Štitnik za lice / Μάσκα κεφαλής προστασίας από θραύσματα / Mascara protectora facial / Schermo di sostituzione per casco autoscurante / Protecção / Protecteur anti-éclats / Bescherming tegen tegen slingerende deeltjes

GRAPHITE

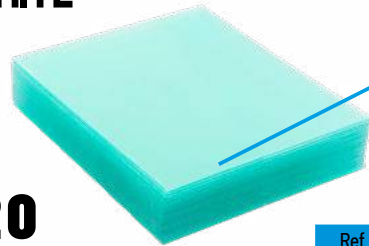

x20



Ref.	☒	EAN
56H824	20/280	5902062022325

TOPEX

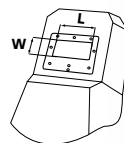

Ref.	L [mm]	W [mm]	☒	EAN
82S210	100	50	0/20	5902062994868
82S211	100	80	0/20	5902062994875

## Koc gaśniczy szklany

Fire blanket / Glas-Feuerlöschdecke / Стеклянное противопожарное одеяло / Сяняне протипажарнае пакрывалю / Üveg tűzvédelmi takaró / Páturá de foc din sticlă / Sklenená protipožární deka / Sklenená protipožariarna prikrývka / Steklena protipožarna odeja / Stiklinis priešgaisrinis apklotas / Stikla ugunsdrošā sega / Tuletõrjetekk / Стыклено противопожарна одеяло / Γυάλινη κουβέρτα φωτιάς / Manta ignífuga de vidrio / Coperta antincendio in vetro / Manta de fogo de vidro / Couverture de feu en verre / Glazen blusdeken

NEO  
TOOLS



1.2  
x  
1.8 m

Ref.	☒	EAN
97-674	0/20	5907558491395



## Rękawice robocze

Working gloves / Arbeitshandschuhe / Ручкави робоче / Руквици работчи / Munkakesztyű / Mänuși de lucru / Pracovní rukavice / Pracovné rukavice / Delovne rokavice / Darbo pirštinės / Darba cimdi / Töökindad / Ръкавици работни / Radne rukavice / Radne rukavice / Γάντια εργασίας / Guantes de trabajo / Guanti da lavoro / Luvas de trabalho / Gants de travail / Werkhandschoenen



Ref.	Size	⊠	EAN
97-640-8	8"	10/100	5907558447811
97-640-9	9"	10/100	5907558447828
97-640-10	10"	10/100	5907558447835

Ref.	Size	⊠	EAN
97-641-8	8"	10/100	5907558447842
97-641-9	9"	10/100	5907558447859
97-641-10	10"	10/100	5907558447866

Ref.	Size	⊠	EAN
97-617-8	8"	10/100	5907558448023
97-617-9	9"	10/100	5907558448030
97-617-10	10"	10/100	5907558448047



Ref.	Size	⊠	EAN
97-643-8	8"	10/100	5907558447903
97-643-9	9"	10/100	5907558447910
97-643-10	10"	10/100	5907558447927

Ref.	Size	⊠	EAN
97-616-8	8"	10/100	5907558447996
97-616-9	9"	10/100	5907558448009
97-616-10	10"	10/100	5907558448016

Ref.	Size	⊠	EAN
97-642-8	8"	10/100	5907558447873
97-642-9	9"	10/100	5907558447880
97-642-10	10"	10/100	5907558447897



Ref.	Size	⊠	EAN
97-630-8	8"	10/100	5907558448115
97-630-9	9"	10/100	5907558448122
97-630-10	10"	10/100	5907558448139

Ref.	Size	⊠	EAN
97-631-8	8"	10/100	5907558448146
97-631-9	9"	10/100	5907558448153
97-631-10	10"	10/100	5907558448160

Ref.	Size	⊠	EAN
97-609-8	8"	10/100	5907558447934
97-609-9	9"	10/100	5907558447941
97-609-10	10"	10/100	5907558447958



Ref.	Size	⊠	EAN
97-610-8	8"	10/100	5907558447965
97-610-9	9"	10/100	5907558447972
97-610-10	10"	10/100	5907558447989

Ref.	Size	⊠	EAN
97-620-8	8"	10/300	5907558448054
97-620-9	9"	10/300	5907558448061
97-620-10	10"	10/300	5907558448078

Ref.	Size	⊠	EAN
97-621-8	8"	10/100	5907558448085
97-621-9	9"	10/100	5907558448092
97-621-10	10"	10/100	5907558448108



## Rękawice robocze

Working gloves / Arbeitshandschuhe / Перчатки рабочие / Рукавици работчи / Munkakesztyű / Mănuși de lucru / Pracovní rukavice / Pracovné rukavice / Delovne rokavice / Darbo pirštines / Darba cimdi / Töökindad / Ръкавици работни / Radne rukavice / Radne rukavice / Γάντια εργασιών / Guantes de trabajo / Guanti da lavoro / Luvas de trabalho / Gants de travail / Werkhandschoenen



**NEO TOOLS** KAT II  
fluorescent  
3142X  
CE

Ref.	Size	⊠	EAN
97-611	10"	0/120	5907558421804



**NEO TOOLS** LATEX COATED  
KAT II  
2242X  
CE

Ref.	Size	⊠	EAN
97-612-8	8"	10/100	5907558484267
97-612-9	9"	10/100	5907558484274
97-612-10	10"	10/100	5907558484281



**NEO TOOLS** LATEX COATED  
KAT II  
X40  
4142X  
CE

Ref.	Size	⊠	EAN
97-613-8	8"	10/100	5907558484298
97-613-9	9"	10/100	5907558484304
97-613-10	10"	10/100	5907558484311



**NEO TOOLS** KAT II  
2121X  
CE

Ref.	Size	⊠	EAN
97-603	10"	12/120	5907558409147
97-604	8"	0/12	5907558407655



**NEO TOOLS** KAT II  
2121X  
CE

Ref.	Size	⊠	EAN
97-605	10"	0/96	5907558412901



**NEO TOOLS** KAT II  
2121X  
CE

Ref.	Size	⊠	EAN
97-606	10"	6/96	5907558412918



**NEO TOOLS** KAT II  
4243X  
CE

Ref.	Size	⊠	EAN
97-650	10.5"	0/120	5907558448177



**NEO TOOLS** KAT II  
4243X  
CE

Ref.	Size	⊠	EAN
97-651	10.5"	0/120	5907558448191



**NEO TOOLS** KAT II  
4333X  
CE

Ref.	Size	⊠	EAN
97-652	10.5"	0/120	5907558448184



**NEO TOOLS** KAT II  
2121X  
CE

Ref.	Size	⊠	EAN
97-655-8	8"	12/120	5907558455748
97-655-9	9"	12/120	5907558455755
97-655-10	10"	12/120	5907558455762



**NEO TOOLS** KAT II  
2121X  
CE

Ref.	Size	⊠	EAN
97-656-8	8"	12/120	5907558455779
97-656-9	9"	12/120	5907558455786
97-656-10	10"	12/120	5907558455793



**NEO TOOLS** KAT II  
2121X  
CE

Ref.	Size	⊠	EAN
97-657-8	8"	12/120	5907558455809
97-657-9	9"	12/120	5907558455816
97-657-10	10"	12/120	5907558455823



## Rękawice robocze

Working gloves / Arbeitshandschuhe / Перчатки рабочие / Рукавици работчи / Munkakesztyű / Mănuși de lucru / Pracovní rukavice / Pracovné rukavice / Delovne rokavice / Darbo pirštines / Darba cimdi / Töökindad / Ръкавици работни / Radne rukavice / Γάντια εργασιών / Guantes de trabajo / Guanti da lavoro / Luvas de trabalho / Gants de travail / Werkhandschoenen

**NEO TOOLS**



**KAT II**  
4132X  
CE

Ref.	Size	⊠	EAN
97-615	10"	12/120	5907558433982

**NEO TOOLS**



**KAT II**  
3123X  
CE

Ref.	Size	⊠	EAN
97-602	10,5"	12/96	5907558406825

**NEO TOOLS**



**LATEX FREE**  
**100% NITRILE**  
SILICONE FREE  
**POWDER FREE**  
x50 pcs by weight

Ref.	Size	⊠	EAN
97-690-M	M	10/10	5907558484489
97-690-L	L	10/10	5907558484496
97-690-XL	XL	50/10	5907558484502

**NEO TOOLS**



**KAT II**  
2111X  
EN607  
222232  
TYPE B  
CE

Ref.	Size	⊠	EAN
97-653	11"	12/120	5907558455830

**NEO TOOLS**



**POLYESTER LATEX COATED**  
**KAT I**  
CE

Ref.	Size	⊠	EAN
97-644-3	3"	0/100	5907558491463
97-644-4	4"	0/100	5907558491470
97-644-5	5"	0/100	5907558491487

**NEO TOOLS**



**LATEX FREE**  
**100% NITRILE**  
SILICONE FREE  
**POWDER FREE**  
x100 pcs by weight

Ref.	Size	⊠	EAN
97-691-M	M	100/10	5907558484519
97-691-L	L	100/10	5907558484526
97-691-XL	XL	100/10	5907558484533

**GRAPHITE**



**kat./cat.**  
2111X  
CE

Ref.	Size	⊠	EAN
97G100	10"	12/120	5902062092700

**TOPEX**



**KAT II**  
3121X  
CE

Ref.	Size	⊠	EAN
83S213	10"	12/60	5902062832139

**TOPEX**



**KAT II**  
4111X  
CE

Ref.	Size	⊠	EAN
83S201	10,5"	12/120	5902062200983

**TOPEX**



**KAT II**  
4111X  
CE

Ref.	Size	⊠	EAN
83S202	10,5"	12/240	5902062230034

**TOP TOOLS**



**KAT I**  
CE

Ref.	Size	⊠	EAN
83S203	9"	12/600	5902062993502





# Pasek

Belt / Gürtel / Ремень / Ремінь / Öv / Curea / opasek / Opasok / Pašček / Dirželis įrankiams / Josta / Rihm / Колан / Pojas / Kaiš / Ζώνη / Cinturón / Cintura / Riem

**NEO**  
TOOLS

COTTON 100% ONE SIZE 130 cm

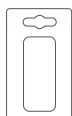

Ref.	L [cm]	☒	EAN
81-900	130	0/160	5907558431148

**NEO**  
TOOLS

COTTON 100% ONE SIZE 130 cm

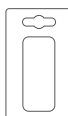

Ref.	L [cm]	☒	EAN
81-901	130	0/150	5907558462319





# **BUDOWLANE**

**BUILDING БУДІВНИЦТВО**



# Młotek ciesielski

Carpenter's hammer / Zimmererhammer / Молоток шиферный / Молоток плотничий / Léckalapács / Ciocan de dulgher / Tesařské kladívko / Kladivo pokrývačské / Tesarsko kladivo / Plaktukas dailidei / Āmurs jumīka / Puusepahaamer / Чук кози крак / Špicasti čekić / Cekić / Σφιρί ξυλουργού / Martillo de carpintero / Martello da meccanico / Martelo p. Madeira / Martelet de charpentier / Timmermanshamer

**NEO**  
TOOLS



**NEO**  
TOOLS

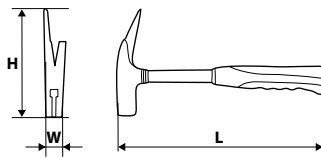

Ref.	m [g]	H [mm]	L [mm]	W [mm]	⊠	EAN
25-101	300	124	285	21,5	6/24	5907558448269
25-102	600	155	320	27	6/24	5907558448276

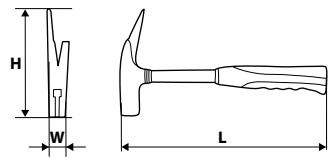

Ref.	m [g]	H [mm]	L [mm]	W [mm]	⊠	EAN
25-131	600	170	340	29	6/24	5907558448337

**TOPEX**



**TOPEX**



Ref.	L [mm]	H [mm]	W [mm]	m [g]	⊠	EAN
02A855	335	175	28	600	6/24	5902062503886

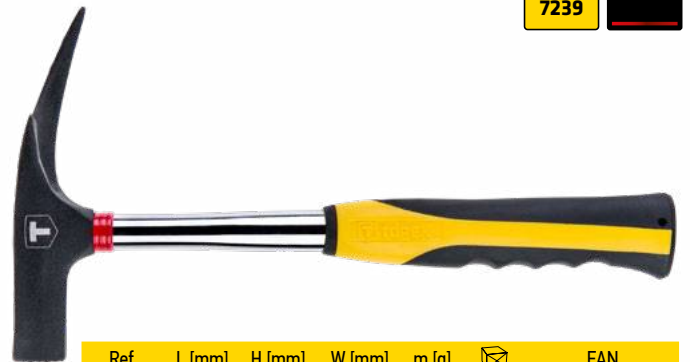

Ref.	L [mm]	H [mm]	W [mm]	m [g]	⊠	EAN
02A140	320	175	28	600	6/24	5902062031600

**TOPEX**



**TOP TOOLS**



Ref.	L [mm]	H [mm]	W [mm]	m [g]	⊠	EAN
02A160	318	175	27	600	6/24	5902062030689

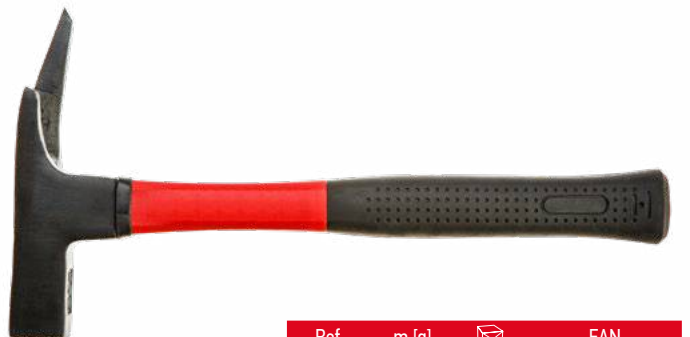

Ref.	m [g]	⊠	EAN
02A912	600	6/24	5902062012562

**TOP TOOLS**



Ref.	m [g]	⊠	EAN
02A180	500	6/24	5902062030139



## Młotek stolarski

Claw hammer / Tischlerhammer / Молоток плотничий / Молоток столярский / Szeghúzókalapács / Ciocan tâmplar / Truhlářské kladívko / Kladivo stolárske / Tesarsko kladivo / Plaktukas staliui / Āmurs galdnieka / Sörghammer / Чук ножи крак / Stolarski čekić / Cekić / Συρίφι ξυλουργού / Martillo de carpintero / Martello ad artiglio / Martelo p. madeira / Martelet de menuisier / Tanghamer

NEO  
TOOLS

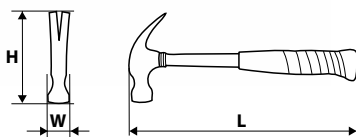

Ref.	m [g]	H [mm]	L [mm]	W [mm]	☒	EAN
25-103	450	130	320	30	6/24	5907558448283
25-104	600	135	320	30	6/24	5907558448290

NEO  
TOOLS

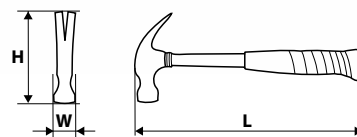

Ref.	m [g]	H [mm]	L [mm]	W [mm]	☒	EAN
25-132	450	135	345	29	6/24	5907558448344

TOPEX



Ref.	L [mm]	H [mm]	W [mm]	m [g]	☒	EAN
02A850	335	10	29,5	450	6/24	5902062503862

TOPEX



Ref.	L [mm]	H [mm]	W [mm]	m [g]	☒	EAN
02A706	332	127	28	450	6/24	5902062030962

TOP TOOLS



Ref.	m [g]	☒	EAN
02A708	450	6/36	5902062030122

TOP TOOLS



Ref.	m [g]	☒	EAN
02A911	450	6/36	5902062012555

## Młotek murarski

Masonry hammer / Maurerhammer / Молоток-кирочка / Молоток каменщика / Kőműves kalapács / Ciocan zidărie / Zednické kladívko / Kladivo murárske / Zidarsko kladivo / Plaktukas mūrīninkui / Āmurs mūrnieka / Miiirivasar / Чук / Zidarski čekić / Cekić / Συρίφι κτίστη / Piqueta de albañil / Martello da muratore / Martelo p. Alvenaria / Martelet de maçons / Metselaarshamer

NEO  
TOOLS

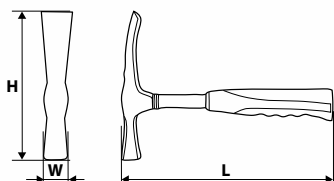
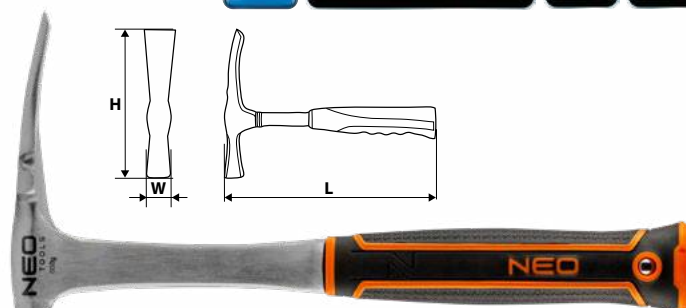

Ref.	m [g]	H [mm]	L [mm]	W [mm]	☒	EAN
25-105	600	190	317	25	6/24	5907558448306

NEO  
TOOLS

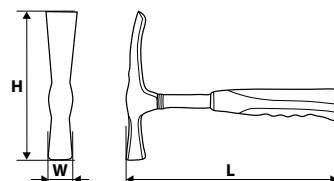
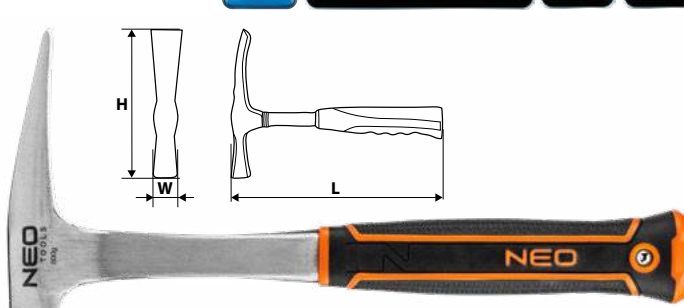

Ref.	m [g]	H [mm]	L [mm]	W [mm]	☒	EAN
25-106	600	167	314	22	6/24	5907558448313



# Młotek murarski

Masonry hammer / Maurerhammer / Молоток-кирочка / Молоток каменщика / Kőműves kalapács / Ciocan zidărie / Zednické kladívko / Kladivo murárske / Zidarsko kladivo / Plaktukas mūrīnkui / Āmurs mūrnieka / Mūrīnvasar / Чук / Zidarski čekić / Cekić / Σφύρι κτίστη / Piqueta de albañil / Martello da muratore / Martelo p. Alvenaria / Martelet de maçons / Metselaarshamer

**NEO**  
TOOLS



**TOPEX**

**DIN 5108**

**HARDENED**



Ref.	m [g]	H [mm]	L [mm]	W [mm]	⊠	EAN
25-133	600	165	343	27	6/24	5907558448351



Ref.	L [mm]	H [mm]	W [mm]	m [g]	⊠	EAN
02A625	288	200	26	600	6/24	5902062031617

**TOPEX**

**DIN 5108**

**HARDENED**



Ref.	L [mm]	H [mm]	W [mm]	m [g]	⊠	EAN
02A635	280	200	26	600	6/24	5902062030696

**TOPEX**

**DIN 5108**

**HARDENED**



Ref.	L [mm]	H [mm]	W [mm]	m [g]	⊠	EAN
02A655	283	160	24	600	6/24	5902062031037

**TOPEX**



Ref.	L [mm]	H [mm]	W [mm]	m [g]	⊠	EAN
02A675	320	200	23	700	0/5	5902062032041

**TOP TOOLS**



Ref.	m [g]	⊠	EAN
02A645	500	6/24	5902062030146

**TOP TOOLS**



Ref.	m [g]	⊠	EAN
02A665	500	6/24	5902062030153

**TOP TOOLS**

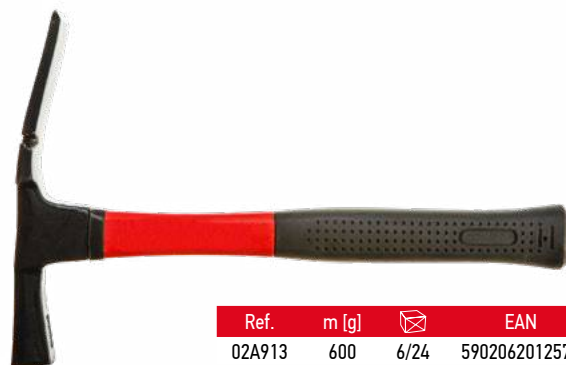

Ref.	m [g]	⊠	EAN
02A913	600	6/24	5902062012579



## Młotek kamieniarski

Stonning hammer / Steinmetzhammer / Молоток-кулачок / Куянка / Kalapács / Ciocan de piatră / Akmenskaldažio plaktukas / Akmens apdares āturs / Mürseravasas / Каменарски чук / Zidarski čekić / Zidarski čekić / Ξιλόφραση / Martillo de cantero / Mazzetta da muratore / Martelo p. Pedras / Martelet à taille de pierres / Steenhamer

NEO  
TOOLS

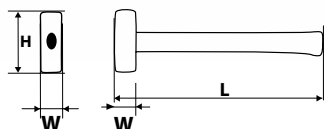

Ref.	m [g]	H [mm]	L [mm]	W [mm]	⊠	EAN
25-107	1500	100	200	40	4/8	5907558448320

NEO  
TOOLS



Ref.	m [g]	H [mm]	L [mm]	W [mm]	⊠	EAN
25-161	4000	173	868	63	0/4	5907558448498
25-162	6000	193	877	73	0/2	5907558448504

TOP TOOLS



Ref.	m [g]	⊠	EAN
02A910	1250	6/12	5902062012548

## Młotek dwuobuchowy

Stoning hammer / Zweibahniger Hammer / Молоток двусторонний / Молоток двосторонний / Kalapács falbontó / Ciocan săpătură / Palička / Obkladačské kladivo / Kladivo macola / Plaktukas dvipusis / Vesperis / Kivihaamer / Чук / Čekić / Macola / Βαριονούλα / Maza / Mazzetta da muratore / Martelo de duas faces / Martelet à tête double / Uitdeukhamer

TOP TOOLS



Ref.	m [g]	⊠	EAN
02A010	1000	0/12	5902062030627
02A012	1250	0/12	5902062030320

## Młotek blacharski

Rubber mallet / Klempnerhammer / Молоток жестящика / Молоток гумовий, слюсарний / Gumikalapács / Ciocan de cauciuc / Klempršské kladívko / Kladivo gumové / Kleparsko kladivo / Skardininko plaktukas / Āmurs skārnieka / Kummihamer / Чук зумен / Gumeni čekić / Čekic / Ματσόλα / Maza de hojalatero / Martello di lattoniere / Martelo p. chapas / Martelet de tôlier / Plaathammer

NEO  
TOOLS

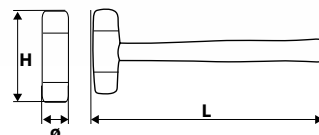
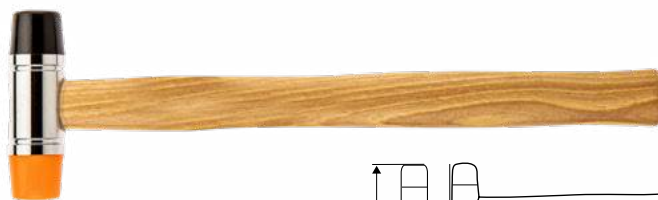

Ref.	m [g]	H [mm]	L [mm]	Ø [mm]	⊠	EAN
11-620	150	75	262	22	6/48	5907558436433
11-621	250	86	280	28	6/48	5907558436440

NEO  
TOOLS



Ref.	m [g]	H [mm]	L [mm]	Ø [mm]	⊠	EAN
11-625	225	80	295	25	6/36	5907558436488

NEO  
TOOLS



Ref.	⊠	EAN
11-640	0/4	5907558436617

TOP TOOLS



Ref.	W [mm]	⊠	EAN
02A330	35	0/40	5902062030368



## Młotek ślusarski

Machinist hammer / Schlosserhammer / Молоток столярный / Молоток слесарный / Kalarács / Zámečnické kladívko / Kladivo zámočnické / Ključavnicaarsko kladivo / Plaktukas šaltkalviui / Āmurs atslēdznieka / Lukksephaamer / Чук / Bravarški čekić / Cekic / Σιδηρή μεταλλοτεχνίτη / Martillo de cerrajero / Martello da meccanico / Martelo p. Fechos / Martelet de serrurier / Slijphamer

**NEO**  
TOOLS

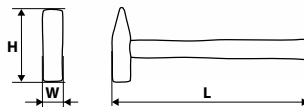

Ref.	m [g]	H [mm]	L [mm]	W [mm]	☒	EAN
25-143	300	100	295	22	6/24	5907558448368
25-144	400	110	295	25	6/24	5907558448375
25-145	500	115	325	27	6/24	5907558448382
25-146	800	130	355	32	6/12	5907558448399
25-147	1000	135	355	35	6/12	5907558448405
25-148	1500	140	410	42	4/8	5907558448412
25-149	2000	155	415	50	4/8	5907558448429

**NEO**  
TOOLS

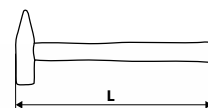
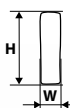

Ref.	m [g]	H [mm]	L [mm]	W [mm]	☒	EAN
25-010	100	258	82	17/12	0/10	5907558400410
25-012	200	280	95	20/12	0/10	5907558440164
25-013	300	300	105	23/12	0/10	5907558400427
25-014	400	310	110	25/12	0/10	5907558440171
25-015	500	315	118	29/6	0/10	5907558400434
25-018	800	345	130	35/6	0/10	5907558400441
25-020	1000	355	135	35/6	0/10	5907558400458
25-025	1500	378	145	42/6	0/6	5907558400465
25-030	2000	395	155	45/6	0/6	5907558400472

**NEO**  
TOOLS



Ref.	m [g]	H [mm]	L [mm]	W [mm]	☒	EAN
25-151	3000	162	865	56	0/6	5907558448436
25-152	4000	174	867	61	0/4	5907558448443
25-153	5000	185	875	67	0/4	5907558448450
25-154	6000	195	880	71	0/2	5907558448467
25-155	8000	207	887	77,5	0/2	5907558448474
25-157	10000	220	893	83	0/2	5907558448481

**T TOPEX**



Ref.	L [mm]	H [mm]	W [mm]	m [g]	☒	EAN
02A715	318	116	29	500	6/24	5902062031631

**T TOPEX**



**T TOPEX**



Ref.	L [mm]	H [mm]	W [mm]	m [g]	☒	EAN
02A832	275	93	19,5	200	6/24	5902062504326
02A833	295	105	23	300	6/24	5902062503817
02A835	320	122	27	500	6/24	5902062503824
02A838	350	130	33,5	800	6/18	5902062503831
02A840	355	135	37,5	1000	6/18	5902062503848

Ref.	L [mm]	H [mm]	W [mm]	m	☒	EAN
02A401	257	82	13	100g	12/72	5902062031433
02A402	285	95	18	200g	12/72	5902062032324
02A403	295	105	24	300g	6/48	5902062031457
02A405	313	117	28	500g	6/36	5902062031471
02A408	340	130	34	800g	6/24	5902062031488
02A410	354	135	37	1000g	4/24	5902062031495
02A415	378	145	43	1500g	6/12	5902062031501
02A420	395	155	45	2kg	4/12	5902062031518
02A530	597	158	55	3kg	0/4	5902062030269
02A540	695	170	63	4kg	0/4	5902062030276
02A550	797	180	70	5kg	0/2	5902062030283
02A560	800	197	70	6kg	0/2	5902062030290
02A580	898	205	80	8kg	0/2	5902062030306
02A511	898	230	85	10kg	0/2	5902062030313



## Młotek ślusarski

Machinist hammer / Schlosserhammer / Молоток столярный / Молоток слесарный / Kalarács / Zámečnické kladívko / Kladivo zámočnické / Kľučovníčarsko kladivo / Plaktukas šaltkalviui / Āmurs atslēdznieka / Lukksepaamer / Чук / Bravarški čekić / Cekić / Σφιρί μεταλλοτεχνίτη / Martillo de cerrajero / Martello da meccanico / Martelo p. Fechos / Martelet de serrurier / Slijphamer



Ref.	m [g]	☒	EAN
02A201	100	12/120	5902062030160
02A202	200	12/96	5902062030177
02A203	300	12/60	5902062030184
02A204	400	12/60	5902062030191
02A205	500	6/36	5902062030207
02A208	800	6/24	5902062030214
02A210	1000	6/18	5902062030221
02A215	1500	0/12	5902062030238
02A220	2000	0/12	5902062030245



Ref.	m [g]	☒	EAN
02A901	100	12/96	5902062012456
02A902	200	6/60	5902062012463
02A903	300	6/36	5902062012470
02A904	400	6/36	5902062012487
02A905	500	6/24	5902062012494
02A906	800	6/18	5902062012500
02A907	1000	6/18	5902062012517

## Młotek gumowy

Sörétes kalarács / Gummitammer / Киянка резиновая / Молоток резиновый / Gumikalarács / ciocan de cauciuc / Gumové kladívko / Kladivo gumové / Gumijasto kladivo / Skardininko plaktukas / Āmurs skārdnieka / Кумтиһаамер / Чук гүмен / Gumeni čekić / Cekić / Λασικένια ματσάλα / Maza de goma / Mazzuola in gomma / Martelo de borracha / Martelet en caoutchouc / Rubberen hamer

NEO TOOLS



HICKORY WOOD

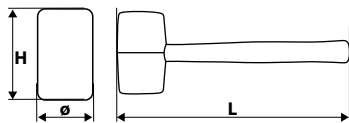

Ref.	m [g]	ø [mm]	H [mm]	L [mm]	☒	EAN
25-052	425	65	340	107	6/24	5907558409482
25-053	680	75	380	120	4/24	5907558409499
25-054	1200	90	380	130	6/12	5907558409405

NEO TOOLS

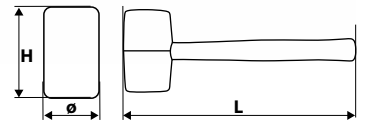
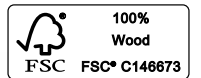

Ref.	m [g]	ø [mm]	H [mm]	L [mm]	☒	EAN
25-061	340	50	88	305	12/48	5907558440096
25-062	450	58	95	340	6/36	5907558440102
25-063	680	63	116	340	6/24	5907558440119
25-064	900	72	120	340	6/18	5907558440126

NEO TOOLS



Ref.	m [g]	ø [mm]	H [mm]	L [mm]	☒	EAN
25-067	450	58	97	338	6/36	5907558440133
25-068	680	63	116	338	6/24	5907558440140

TOPEX



Ref.	L [mm]	H [mm]	ø [mm]	m [g]	☒	EAN
02A343	305	88	50	340	12/48	5902062032201
02A344	340	95	58	450	6/36	5902062032218
02A345	337	116	63	680	6/24	5902062032225
02A347	338	120	72	900	6/18	5902062032232

TOPEX



Ref.	L [mm]	H [mm]	ø [mm]	m [g]	☒	EAN
02A354	338	97	58	450	6/36	5902062032270
02A355	337	116	63	680	6/24	5902062032287

TOPEX

HARDENED



Ref.	L [mm]	H [mm]	ø [mm]	m [g]	☒	EAN
02A305	325	96	65	450	6/36	5902062031402





## Młotek gumowy

Sörétes kalapács / Gummihammer / Киянка резиновая / Молоток резиновый / Gumikalapács / ciocan de cauciuc / Gumové kladívko / Kladivo gumové / Gumijasto kladivo / Skardininko plaktukas / Āmurs skārdnieka / Kummihamer / Чук зумен / Gumeni čekić / Čekić / Λαστιχένια ματσάλα / Maza de goma / Mazzuola in gomma / Martelo de borracha / Martelet en caoutchouc / Rubberen hamer



Ref.	m [g]	Ø [mm]	☒	EAN
02A310	225	40	0/50	5902062030979



Ref.	m [g]	Ø [mm]	☒	EAN
02A315	1250	90	0/12	5902062030351



Ref.	m [g]	Ø [mm]	☒	EAN
02A320	320	55	0/48	5902062030337
02A325	400	60	0/36	5902062030344

## Młotek drewniany

Wooden hammer / Holzhammer / Киянка деревянная / Молоток деревянный / Fakalapács / Ciocan din lemn / Dřevěné kladívko / Kladivo drevené hranaté / Kladivo / Medinis plaktukas / Āmurs koka / Puuhaamer / Чук дървен / Drveni čekić / Čekić / Ξύλινο σφυρί / Maza de madera / Martello in legno / Martelo de madeira / Martelet en bois / Houten hamer



Ref.	L [mm]	m [g]	☒	EAN
02A050	315	500	0/30	5902062205001

## Młotek z wymiennymi końcówkami

Hammer with exchangeable tips / Hammer mit auswechselbaren Oberteilen / Молоток со сменными наконечниками / Молоток зі змінними наконечниками / Cserélhető fejű kalapács / Ciocan cu capete schimbabile / Palička s výměnnými koncovkami / Kladivo s vymeniteľnými hrotmi / Kladivo z zamenljivimi konicami / Plaktukas su keičiamais antgaliais / Āmurs ar maiņas uzgaļiem / Vahetatavate otsakutega haamer / Чук със сменяеми накрайници / Čekić sa izmjenjivim nastavcima / Čekić za zamenskim delovima / Ματσάλα με εναλλάξιμα άκρα / Martillo con puntas intercambiables / Martello con punte intercambiabili / Martelo com pontas substituíveis / Marteau avec embouts interchangeables / Hemer met uitwisselbare eindstukken



Ref.	m [g]	ø [mm]	H [mm]	L [mm]	☒	EAN
11-634	250	28	114	437	6/24	5907558436570
11-636	660	45	150	430	4/8	5907558436594

## Młotek bezodrzutowy

Dead blow hammer / Hammer ohne Rückschlag / Молоток безинерционный / Молоток безінерційний / Visszarúgás-mentes kalapács / Ciocan fără recul / Kladivo bez zpětného nárazu / Kladívko s tlmením odrazu / Kladivo brez povratnega udarca / Plaktukas be atatranks / Bezinerces āmurs / Kummihamer / Безоткатен чук / Неповратні čekić / Bestrajni čekić / Ματσάλα / Martillo anti-rebote / Martello antirimbalo / Martelo / Martelet sans rebond / Vuisthamer

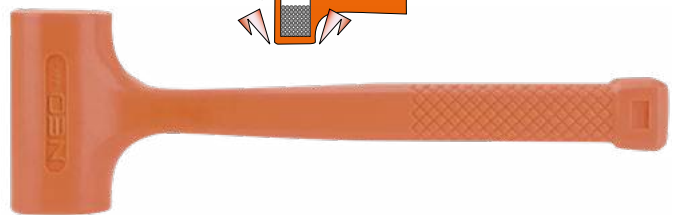
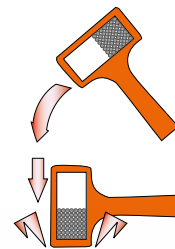

Ref.	m [g]	H [mm]	L [mm]	W [mm]	☒	EAN
25-071	840	324	100	50	6/24	5907558408935
25-072	940	338	100	53	6/18	5907558408942
25-073	1360	350	117	60	0/12	5907558408959



Ref.	L [mm]	Ø [mm]	☒	EAN
02A057	290	70	0/40	5902062205070



## Мłотек spawalniczy

Welding hammer / Schweißerhammer / Молоток сварочный / Молоток зварювальний / Salakverőkalapács / Ciocan lucrări sudare / Svářečské kladívko / Kladívko zváračské / Varilno kladivo / Plaktukas suvirintąjui / Āmurs metinātāja / Keevitushaamer / Чук за зварчуци / Čekić za varioce / Cekic / Σφυρί συγκολλητού / Martillo de soldador / Martello da saldatore / Martelo p. Soldagem / Martele de soudure / Lashamer

**TOPEX**

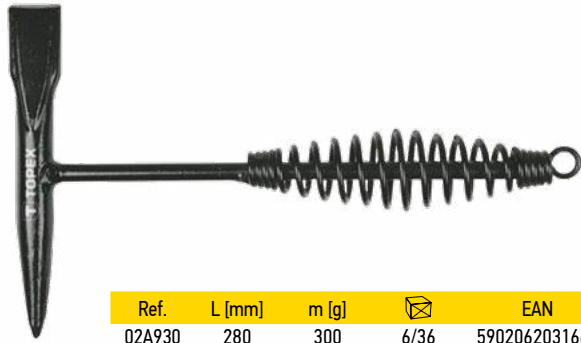

Ref.	L [mm]	m [g]	☒	EAN
02A930	280	300	6/36	5902062031662

## Trzonek do pilnika

File handle / Handgriff für Pfeile / Ружојатка для напильника / Хвостовик до напилька / Reszelőnyél / Måner de pilă / Násada pilníku / Stopka pilníka / Ročaj za pilo / Rankenélé dildei / Viles spals / Viilikäepide / Дръжка на пилата / Ručka za turpiju / Držac za turpije / Χερούλι ράσας / Mango para lima / Impugnatura per lima / Cabo p. Lima / Manche de lime / Handvat voor vijl

**TOPEX**



Ref.	L [mm]	☒	EAN
06A615	115	0/100	5902062948830
06A635	135	0/50	5902062948847

## Trzonek

Shank / Stiel / Ружојатка / Хвостовик / Kalapácsnyél / Måner / Násada / Tříň / Ročaj / Kotas / Spals / Vars / Цокъл / Držak / Drška, držalo / Χερούλι / Vástago / Manico per martello / Cabo / Manche / Handvat

**TOPEX**



Ref.	do młotka [kg]	L [mm]	☒	EAN
02A082	0,5	320	0/50	5902062031792
02A083	1,0	360	0/50	5902062031808
02A084	2,0	400	0/50	5902062031815
02A085	3,0	500	0/25	5902062031822
02A087	5,0 - 6,0	700	0/25	5902062031846
02A088	8,0	800	0/20	5902062031853
02A089	10,0	900	0/10	5902062031860

## Piła płatnica

Hand saw / Fuchsschwanzsäge / Пила-ножовка / Ножовка / Kézifűrés / Ferestrău manual / Pilka ocaska / Pilka ručná / Ročna žaga / Pjåklas medžiui / Ząjis kokam / Käsisaag / Τριων / Pila ručna / Testera rucna / Σεγάτα / Serrucho de carpintero / Segá a mano / Serra / Scie égoïne / Handzaag

**NEO TOOLS**



**EXTREME**



Ref.	L [mm]	TPI	☒	EAN
41-111	400	7	6/24	5907558451573
41-116	450	7	6/24	5907558451580

**NEO TOOLS**



**EXTREME**



Ref.	L [mm]	TPI	☒	EAN
41-131	400	7	6/24	5907558451528
41-136	450	7	6/24	5907558451535
41-141	500	7	6/24	5907558451542

**NEO TOOLS**



**EXTREME**



Ref.	L [mm]	TPI	☒	EAN
41-161	400	11	6/24	5907558451559
41-166	450	11	6/24	5907558451566

**TOPEX**



Ref.	L [mm]	☒	EAN
10A441	400	10/60	5902062103390
10A446	450	10/40	5902062103406
10A451	500	10/40	5902062103413



## Piła platnica

Hand saw / Fuchsschwanzsäge / Πύλα-νοήσοβκα / Ноҳшоёка / Kézifűrés / Ferestrău manual / Pilka oscaka / Pilka ručná / Ročna žaga / Pjūklas medžiui / Zāģis kokam / Käsisaag / Τριων / Pila ručna / Testera rucna / Σεγάτα / Serrucho de carpintero / Segá a mano / Serra / Scie égoïne / Handzaag

**TOPEX**



Ref.	L [mm]	☒	EAN
10A440	400	10/40	5902062647405
10A445	450	10/40	5902062647450
10A450	500	10/40	5902062647504
10A453	560	10/40	5902062104502

**TOPEX**



Ref.	L [mm]	☒	EAN
10A442	400	10/60	5902062104472
10A447	450	10/40	5902062104489
10A452	500	10/40	5902062104496

**TOP TOOLS**

**TPI 7**



Ref.	L [mm]	☒	EAN
10A540	400	10/50	5902062100887
10A545	450	10/40	5902062100894
10A550	500	10/40	5902062100900

**TOP TOOLS**

**TPI 6**



Ref.	L [mm]	☒	EAN
10A640	400	0/50	5902062101273
10A645	450	0/50	5902062101280

**TOP TOOLS**

**TPI 9**



Ref.	L [mm]	☒	EAN
10A504	400	0/50	5902062100856
10A505	450	0/50	5902062100863
10A506	500	0/50	5902062100870

## Piła japońska do cięcia dokładnego

Japanese precision cutting saw / Japansäge für feine Schnitte / Японская пила для точной резки / Японська пила для точної різки / Japán fűrész precíz vágáshoz / Fierăstrău japonez pentru tăiere fină / Japonská pila pro přesné řezy / Japonská pila na presné rezanie / Japonska žaga za natančno rezanje / Japoniškas tikslusis pjūklas / Japāņu zāģis precīzai griešanai / Jaapani saag täpissaagimiseks / Японски трион за фино рязане / Japonska pila za fino rezanje / Japonska testera za fino sečenje / Јапонско прѝони акрѝивоус копѝѝ / Sierra japonesa de corte fino con / Segá giapponese da taglio fine / Serra japonesa para cortes finos / Scie japońska pour coupe fine / Japane zaag voor fijne werkzaamheden

**NEO TOOLS**



Ref.	☒	EAN
44-610	6/48	5907558463699

**NEO TOOLS**



Ref.	☒	EAN
44-611	6/48	5907558463682

**NEO TOOLS**



Ref.	☒	EAN
44-612	6/48	5907558463675

**NEO TOOLS**



Ref.	☒	EAN
44-613	6/48	5907558463668



## Piła kątowa

Mitre saw / Winkelsäge / Угловой / Стусло / Gémvágó állványos / Ferestrău tăiere sub unghi / Úhlová pila / Píłka uhlová / Kotna žaga / Pjūklas kampams / Leņķa zāģis / Saag / Машинка за перази / Pila za sječenje pod kutom / Testera za secenje pod uglom / Φαλσοπίοιο / Sierra angular / Sega angolare di precisione / Serra de canto / Scie d'angle / Versteekzaag

NEO  
TOOLS

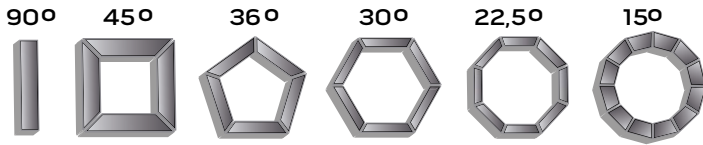

Ref.	L [mm]	☒	EAN
44-600	600	0/4	5907558408621

TOPEX



Ref.	L [mm]	☒	EAN
10A055	550	0/1	5902062100320

TOP TOOLS



Ref.	L [mm]	☒	EAN
10A035	550	0/4	5902062100795

## Piła do metalu

Hacksaw / Metallsäge / Ножовка по металлу / Ножовка по металлу / Fémfűrés / Ferestrău pentru metal / Pila na kov / Píłka na kov / Žaga za kovino / Metalo pjūklas / Zāģis metālam / Metallsaag / Τριον για μέταλλο / Pila za metal / Testera za metal / Πριόνι μετάλλου / Sierra para metal / Lama per sega ad arco / Serra para metal / Scie à métal / Zaag voor metaal

NEO  
TOOLS



Ref.	L [mm]	☒	EAN
43-300	300	6/36	5907558401387

NEO  
TOOLS



Ref.	L [mm]	☒	EAN
43-301	300	5/20	5907558447149

NEO  
TOOLS



Ref.	L [mm]	☒	EAN
43-302	300	1/24	5907558447156

NEO  
TOOLS



Ref.	L [mm]	☒	EAN
43-310	150	10/60	5907558447163



## Piła do metalu

Hacksaw / Metallsäge / Ножовка по металлу / Ножовка по металлу / Fémfűrész / Ferăstrău pentru metal / Pila na kov / Píla na kov / Žaga za kovino / Metalo pjūklas / Zągjis metālam / Metallisaag / Τριων σε μεταν / Pila za metal / Testera za metal / Πριόνι μετάλλου / Sierra para metal / Lama per sega ad arco / Serra para metal / Scie à métal / Zaag voor metaal

**TOPEX**



Ref.	L [mm]	☒	EAN
10A115	150	6/72	5902062631657

**TOPEX**



150 [mm]

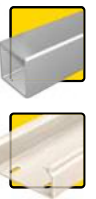

Ref.	L [mm]	☒	EAN
10A150	150	12/72	5902062032560

**TOPEX**



Ref.	L [mm]	☒	EAN
10A130	300	6/24	5902062102744

**TOPEX**



Ref.	L [mm]	☒	EAN
10A135	300	6/36	5902062100771

**TOPEX**



Ref.	L [mm]	☒	EAN
10A145	300	6/36	5902062103277

**TOPEX**



Ref.	L [mm]	☒	EAN
10A225	250-300	12/48	5902062100153

**TOPEX**

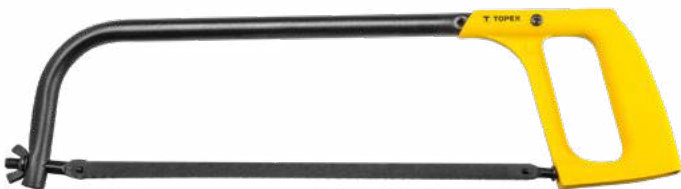

Ref.	☒	EAN
10A160	6/24	5902062032508

**TOP TOOLS**



Ref.	L [mm]	☒	EAN
10A230	300	12/48	5902062100146

**TOP TOOLS**



Ref.	L [mm]	☒	EAN
10A235	300	12/48	5902062100139



## Piła grzbietnica

Back saw / Rückensäge / Ножовка пасовочная / Ножовка пасовочна / Illesztőfűrész / Ferestrău / Piła hřbetovka / Piła čarovka / Lisičji rep / Pjūklas / Žāģis leņķiem / Kāsisaag / Трион пасовачен / Piła ręczna / Testera ręczna / Φαλκονπίοιο / Serrucho de costilla / Segá a dorso / Serra de costado / Scie à dos / Rugzaag

NEO  
TOOLS

**EXTREME** 

HARDENED  
STEEL

13  
TPI



Ref.	L [mm]	TPI	⊠	EAN
41-226	350	13	6/24	5907558455281



HARDENED

300  
[mm]

9TPI

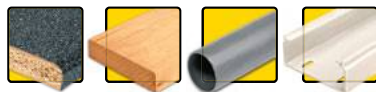



Ref.	⊠	EAN
10A710	0/12	5902062032485

**TOPEX**

HARDENED



Ref.	L [mm]	info	⊠	EAN
10A703	300	 9TPI	10/40	5902062101358
10A706	350	 13TPI	10/40	5902062103185

**TOP TOOLS**



Ref.	L [mm]	⊠	EAN
10A713	300	10/60	5902062100221

## Piła do płyt gipsowo-kartonowych

Wallboard saw / Säge für Gipskartonplatten / Ножовка по гипсокартону / Ножовка по гипсокартону / Gipskartonfűrész / Ferestrău pentru plăci gips carton / Piła na sádrokartón / Piła na sadrokartón / Žaga za plošče karton-gips / Pjūklas gipso kartono plokštėms / Žāģis ģipškartona plāksnēm / Kipsplaaidsaag / Трион за гипсово-картонени плочи / Piła za kartonsko-gipsane ploče / Testera za gipsano-kartonske ploče / Πρίονι γυψοσανίδας / Sierra para placas de yeso laminado / Segá per lastre in gesso / Serra p. chapas de gesso e papelão / Scie à planches de plâtre / Zaag voor gipskartonplaten

**TOPEX**

HARDENED

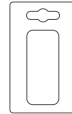

Ref.	L [mm]	⊠	EAN
10A717	150	12/72	5902062103161
10A719	250	12/72	5902062032522

**TOPEX**

HARDENED

150  
[mm]

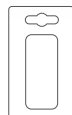

Ref.	L [mm]	⊠	EAN
10A717P	150	12/36	5902062032515

**TOP TOOLS**



Ref.	L [mm]	⊠	EAN
10A715	150	10/40	5902062646606

## Piła do płyt G/K i nóż do wełny mineralnej

Wallboard saw and mineral wool knife / Gipskartonsäge mit messer und Schneiden von Mineralwolle / Ножовка для гипсокартонных плит и нож для минеральной ваты / Ножовка по гипсокартону и нож для минеральной ваты / Gipskarton és üveggyapotfűrész / Ferestrău placă perete și cuțit pentru vată de sticlă / Piła na desky G/K a nůž na minerální vlnu / Piła na sadrokartón a nůž na minerálnu vlnu / Žaga za plošče iz gipsa/kartonu in rezilo za mineralno valno / Pjūklas gipso kartonui ir peilis mineralinei vatai / Žāģis ģipškartonam un minerālvates nazis / Seinaplaadi saag ja mineraalvillanuga / Трион и нож за минерална вата / Piła za gips karton i noż za mineralnu vunu / Testera za gips karton i nož za mineralnu vunu / Πρίον για πλακάκια G/K και κόπτης πετροβάμβακα / Serrucho para placas de yeso laminado y cuchillo para lana mineral / Segá per lastre in gesso e coltello per lana di roccia / Serra p. chapas G/K e faca para lâ mineral / Scie à planches de plâtre et couteau pour laine de verre /

**TOPEX**

STAINLESS  
STEEL

480  
[mm]  
335  
[mm]



x2



HARDENED

150  
[mm]



Ref.	⊠	EAN
10A725	0/24	5902062032546



## Nóż do wełny mineralnej

Knife for mineral wool / Messer zum Schneiden von Mineralwolle / Нож для минеральной ваты / Нож для минеральной ваты / Szigetelésanyagvágó kés / Cuiț pentru vată de sticlă / Nůž na minerální vlnu / Nůž na minerálnu vlnu / Reziło za mineralno volno / Peilis mineralinei vatai / Minerālvates nazis / Mineratvillanuga / Нож за минерална вата / Nož za mineralnu vunu / Nož za mineralnu vunu / Κόπτης πετροβάμβακα / Cuchillo para lana mineral / Coltello per lana di roccia / Couteau pour laine de verre / Mes voor mineral wool

**TOPEX**

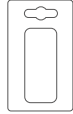

Ref.	L <sub>1</sub> [mm]	L <sub>2</sub> [mm]	⊠	EAN
17B900	480	335	10/60	5902062141156

## Piła do betonu komórkowego

Cellular concrete saw / Säge für Zellenbeton / Ножовка для пеноблоков / Ножовка по газобетону / Gázbetonfűrész / Ferăstrău pentru beton celular (BCA) / Pila na rórobeton / Pila na kotłrkový betón / Žaga za čelični beton / Pjūkļas akrytam betonui / Gāzbetonabetaņa zāģis / Saag kergbetooni saagimiseks / Τριων за клетъчен бетон / Pila za betonske blokice / Testera za čelijski beton / Πριόνι ελαφρού μπετό / Sierra para bloques de hormigón celular / Segá per cemento cellulare / Serra p. Betão / Scie pour béton poreux / Zaag voor celbetonblokken

**NEO TOOLS**

65 Mn HM



Ref.	L [mm]	T	⊠	EAN
41-201	800	23	6/12	5907558452952

**TOPEX**

HM

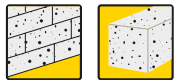

Ref.	L [mm]	⊠	EAN
10A760	600	0/12	5902062646170

**TOPEX**

HM 1,5mm



Ref.	L [mm]	⊠	EAN
10A761	600	6/12	5902062646187

## Piła otwornica

Compas saw / Stichsäge / Ножовка узкая / Сучкоріз / Lyukfűrész / Ferestrău de traforaj / Pila děrovka / Pila zlodejka / Ozka žaga / Pjūkļas angoms / Zaru zāģis / Sirkelsaag / Τριων οσοιτάρσκυ / Pila uska / Testera uska / Πριόνι για ξύλο / Serrucho de punta / Segá a punta / Serra p. recortes / Scie à guichet / Gatenzaag

**NEO TOOLS**

TÜV Rheinland CERTIFIED

300 mm

11 TPI

LASER

HARD POINT



Ref.	L [mm]	TPI	⊠	EAN
41-091	300	11	12/48	5907558407075

**TOPEX**

HARDENED

9TPI



Ref.	L [mm]	⊠	EAN
10A722	200	10/40	5902062032492
10A723	300	10/40	5902062101303

**TOP TOOLS**



Ref.	L [mm]	⊠	EAN
10A733	300	0/80	5902062100238

## Brzeszczot do metalu

Hacksaw blade / Metallsägeblatt / Полотно по металлу / Полотно ножикове / Fémfűrész lap / Píňzä ferăstrău / Ostří na kov / Pila na kov / Reziło za kovino / Geležite metalui / Žaga asmenis metalam / Rauasaeleht / Лист за ножовка / List Pile / List testere / Λάμα για σιδεροπρίονο / Hoja de sierra para metal / Lama per metalli / Lâmina p. metal / Lame de scie à métal / Lemmet voor metaal

**NEO TOOLS**

SK4 steel

150 mm

24 TPI

x5



Ref.	L [mm]	⊠	EAN
43-350	150	20/200	5907558462531

**NEO TOOLS**

300 mm

24 TPI

x5



Ref.	L [mm]	⊠	EAN
43-355	300	60/120	5907558462548



## Brzeczot do metalu

Hacksaw blade / Metallsägeblatt / Полотно по металлу / Полотно ножиковое / Fémfűrész lap / Pínză ferăstrău / Ostří na kov / Pilka na kov / Rezilo za kovino / Gelește metalui / Zăga asmenis metălám / Rauasaeleht / Лист за ножовка / List Pile / List testere / Λάμα για αιδροπρίοιο / Hoja de sierra para metal / Lama per metalli / Lâmina p. metal / Lame de scie à métal / Lemmet voor metaal

**TOPEX**

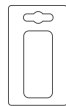

Ref.	L [mm]	W [mm]	⊠	EAN
10A330	300	12,5	50/500	5902062101655

**TOP TOOLS**

x12

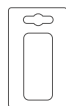

Ref.	L [mm]	W [mm]	⊠	EAN
10A339	300	12,5	12/96	5902062100160

## Brzeczot do metalu i drewna

Blade for metal and wood / Sägeblatt für Metall und Holz / Полотно по металлу и дереву / Полотно пильное по металлу и дереву / Fűrészlap fa-fém / Pânză de ferăstraie pentru metale și lemn / Pilový list na kov a dřevo / Čepele na kov a drevo / Žagni list za kovino in les / Pjūkluukas metalui ir medžiui / Metāla un koksnes zāģis / Saeleht metalli ja puidu saagimiseks / Ленту за метал и дървесина / Pile za metal i drvo / Sečiva za metal i drvo / Πριονόλαμα μετάλλου και ξύλου / Hoja de sierra para metal y madera / Lama per seghetto / Lâminas p. metal e madeira / Lames de scie à métal et à bois / Mesblad voor metaal en hout

**TOPEX**

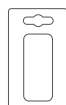

Ref.	L [mm]	W [mm]	N	⊠	EAN
10A337	300	25	x1	72/720	5902062638502
10A336	300	25	x5	1/50	5902062104557
10A337-72	300	25	x72	0/10	5902062104588

**TOPEX**

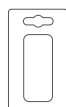

Ref.	L [mm]	⊠	EAN
10A065	550	50/200	5902062100344

## Uchwyt do brzeczotu

Hacksaw blade holder / Sägeblatthalterung / Держатель для полотна ножовки / Замискач до полотена ножиковових / Fémfűrész / Fixator pínză ferăstrău / Držák ostří / Držiak pilových plátok, kov/drevo / Vpenjalo za rezilo / Rankena asmenims / Zăga asmena turătăjs / Rauasaelehe hoidik / Ножовка / Držac Pile za metal-drvo / Drzac testere za metal / Λάμα για αιδροπρίοιο / Mango para hoja de sierra / Lama con impugnatura in plastica / Suporte do Lâmina / Monture à lame de scie / Mesbladhouder

**NEO TOOLS**

BI-MATERIAL HANDLE

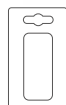

Ref.	L [mm]	⊠	EAN
43-320	300	0/100	5907558447170

**TOPEX**

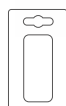

Ref.	L [mm]	⊠	EAN
10A214	300	0/70	5902062103383

**TOPEX**

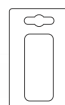

Ref.	L [mm]	W [mm]	info	N	⊠	EAN
10A335	300	25	dwustronny	x5	0/50	5902062100177
10A333	300	25	dwustronny	x24	0/50	5902062104540
10A332-72	300	25	dwustronny	x72	0/10	5902062104571

**TOP TOOLS**

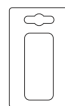

Ref.	L [mm]	W [mm]	⊠	EAN
10A310	300	25	36/720	5902062104625

## Brzeczot do piły kątovej

Mitre saw blade / Winkelsägeblatt / Полотно для углореза / Полотно до ступца / Fűrészlap gérvágóhoz / Lamă ferăstrău pentru tăiere sub unghi / Ostří do úhlové pily / Plátok pre píľku / Rezilni list za katno žago / Pjūkluukas kampų pjovimo pjūklui / Asmenis lenška zāģim / Saeleht / Pezere / List Pile za pilu pod kutom / List testere za testeru pod uglom / Λάμα για φαλτοπρίοιο / Hoja de sierra angular / Lama per sega angolare di precisione / Lâmina / Lame de scie pour scie d'angle / Lemmet voor verstekzaag

**NEO TOOLS**

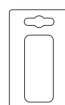

Ref.	L [mm]	⊠	EAN
44-618	600	0/100	5907558408638



**NEO TOOLS**



Ref.	L [mm]	⊠	EAN
43-321	300	20/100	5907558465358

**TOPEX**



Ref.	L [mm]	⊠	EAN
10A216	300	10/100	5902062032553





## Skrzynka uciosowa

Mitre box / Schneidschablone / Стычно / Стычно / Gérláda / Ímbinare 'inclinatá lemn / Pokosnice / Vodítko ukosové / Jeralni predalčnik / Lovelis kampams pjauti / Trafarete leŋka zágim / Nurgalóikuskast / Пассамен / Šablona za kutove / Ger / Φαλτσοκούι / Guia de sierra / Dima per cornici / Caixa / Boíte de coupe / Houten tist

**TOPEX**



Ref.	L [mm]	W [mm]	H [mm]	☒	EAN
10A803	300	65	45	0/25	5902062100412

**TOPEX**



Ref.	L [mm]	W [mm]	H [mm]	☒	EAN
10A822	220	45	55	0/70	5902062101365
10A824	240	55	70	0/50	5902062101020
10A827	280	85	85	0/30	5902062202000

**TOPEX**



Ref.	L [mm]	W [mm]	H [mm]	☒	EAN
10A840	212	42	44	0/40	5902062103031
10A842	233	53	56	0/30	5902062103048
10A843	250	65	60	0/30	5902062103208
10A844	295	80	70	0/30	5902062103055
10A846	320	120	75	0/18	5902062103062

**TOPEX**



Ref.	L [mm]	W [mm]	H [mm]	info	☒	EAN
10A848	320	120	75	z zaciskami	0/18	5902062103079

## Nożyce do prętów

Mini bolt cutter / Stabschere / Ножицы для проволоки / Ножицы для дроты / Csapszegvágó / Scule tăiere minişeruburi / Blokové nůžky / Strihač svorníkov / Škarje za žico / Mini žirkles armatūrai / Skrūvjkodis mini / Poldilóikur (váike) / Ножица за арматура / Škare za armaturu / Makaze za armaturu / Μίνι μπουλονκόφτης / Cortavarillas / Tronchese / Tesoura p. Vergas / Cisaille à fers plats / Scharen voor stangen

**NEO TOOLS**



Ref.	L [mm]	ø [mm]	☒	EAN
31-018	450	8	6/12	5907558400564
31-024	600	10	1/6	5907558400571
31-030	750	12	0/4	5907558400588
31-035	900	16	0/2	5907558400595

**NEO TOOLS**



Ref.	L [mm]	ø [mm]	☒	EAN
31-019	450	8	0/10	5907558406979
31-025	600	10	0/10	5907558406986

**TOPEX**

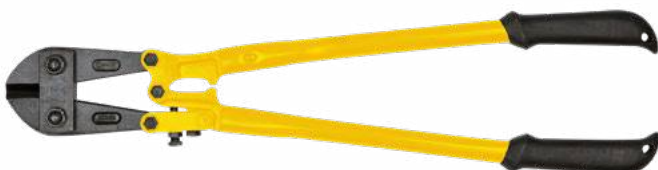

Ref.	L [mm]	Ø max. [mm]	☒	EAN
01A118	450	8	0/12	5902062011343
01A124	600	10	0/8	5902062011350
01A130	750	12	0/5	5902062011398
01A135	900	16	0/4	5902062011558

**TOPEX**



Ref.	L [mm]	Ø max. [mm]	☒	EAN
01A117	210	4	10/60	5902062011381

**TOP TOOLS**



Ref.	L [mm]	Ø max [mm]	☒	EAN
01A218	450	6	0/10	5902062010353
01A224	600	8	0/10	5902062010360



## Ноżyce do blachy

Tin snip / Blechscherer / Ножицы по жесту / Ножицы по листовому металлу / Lemezolló balos / Foarfecce täiere tablă / Nůžky na plech / Nožnice na plech / Škarje za pločevino / Žirklés skardai / Grieznes skārdam / Plekikäärid / Ножица за ламарина / Škare za lim / Makaze za lim / Ψαλίδι λαμαρίνας / Tijeras corta chapa / Cesoia / Tesoura para chapa / Cisaille coupe-tôle / Bliksharen

**NEO**  
TOOLS

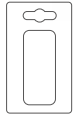

Ref.	typ/type/тип	L [mm]	☒	EAN
31-050	proste/straight/прямі	250	6/48	5907558400601
31-055	prawe/right/праві	250	6/48	5907558400618
31-060	lewe/left/ліві	250	6/48	5907558400625

**NEO**  
TOOLS



Material/Material/Матеріал

Stal/Steel/Сталь  
Stal hartowana HRC35/Hardened steel HRC35/  
Загартована сталь, HRC35  
Aluminium/Aluminium/Алюміній  
Miedz/Brass/Мідь  
Tworzywo sztuczne/Plastic/Пластик

Grubość cięcia/Cutting thickness/  
Товщина різання [mm]

0,6  
0,3  
1,0  
1,1  
5,0

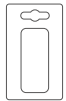

Ref.	L [mm]	☒	EAN
31-061	290	6/48	5907558409420

**NEO**  
TOOLS



**CrMo**  
steel

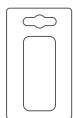

Ref.	typ/type/тип	L [mm]	☒	EAN
31-081	prawe/right/праві	260	6/36	5902062062994
31-083	prawe/right/праві	280	6/36	5902062063014
31-085	prawe/right/праві	300	6/24	5902062063038
31-082	lewe/left/ліві	260	6/24	5902062063007
31-084	lewe/left/ліві	280	6/24	5902062063021
31-086	lewe/left/ліві	300	6/24	5902062063045

**NEO**  
TOOLS



**TÜV Rheinland**  
CERTIFIED  
**CrMo**  
steel

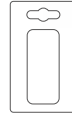

Ref.	typ/type/тип	L [mm]	☒	EAN
31-062	lewe/left/ліві	240	6/36	5907558409550
31-063	prawe/right/праві	240	6/36	5907558409567

**NEO**  
TOOLS



Material/Material/Матеріал

Stal/Steel/Сталь  
Stal hartowana HRC35/Hardened steel HRC35/  
Закаленна сталь HRC35  
Aluminium/Aluminium/Алюміній  
Miedz/Brass/Мідь  
Tworzywo sztuczne/Plastic/Пластмаса

Grubość cięcia/Cutting thickness/  
Товщина різання [mm]

0,9  
0,7  
1,0  
1,1  
5,0

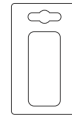

Ref.	L [mm]	☒	EAN
31-065	250	6/36	5907558407440

**T TOPEX**



**CrV**

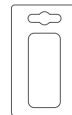

Ref.	L [mm]	info	☒	EAN
01A425	250	lewe/left/ліві	6/48	5902062180353
01A426	250	prawe/right/праві	6/48	5902062180360
01A427	250	proste/straight/прямі	6/48	5902062180377

**T TOPEX**

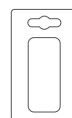

**DIN**  
6438

Ref.	L [mm]	☒	EAN
01A440	250	6/36	5902062180513



## Nożyce do blachy

Tin snip / Blechscherer / Ножницы по жесту / Ножницы по листовому металлу / Lemezöllő balos / Foarfeca tăiere tablă / Nůžky na plech / Nožnice na plech / Škarje za pločevino / Žirkles skardai / Grieznes skārdam / Plekikäärid / Ножница за ламаруна / Škare za lim / Makaze za lim / Ψαλίδι λαμαρίνας / Tijeras corta chapa / Cesoia / Tesoura para chapa / Cisaille coupe-tôle / Blikscharen

**TOPEX**

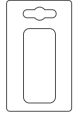

Ref.	L [mm]	⊠	EAN
01A445	300	6/24	5902062180728

**TOP TOOLS**

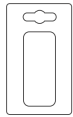

Ref.	L [mm]	info	⊠	EAN
01A552	260	stright	6/36	5902062180254
01A554	320	-	5/30	5902062180278

**TOP TOOLS**

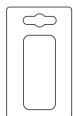

Ref.	L [mm]	info	⊠	EAN
01A998	250	left	10/50	5902062011725
01A999	250	right	10/50	5902062011732
01A997	250	stright	10/50	5902062010339

## Nożyce do wykładzin

Carpet scissors / Schere für Teppichböden / Ножницы для резки напольных покрытий / Ножницы для килимового покриття / Szőnyegvágó olló / Foarfeca pentru căptușeală / Nůžky na koberce / Nožnice na krytiny / Škarje za talne obloge / Žirkles kiliminei dangai / Škėres grėdas seguma griešanai / Vaibakäärid / Ножницы за монет / Škare za podne podloge / Makaze za oplatu / Ψαλίδι για τάπητες βαπέδου / Tijeras para moqueta / Forbici ad uncino / Tesoura para tapetes / Cisaille à moquette / Schaar voor tapijten

**NEO TOOLS**

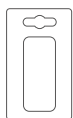

Ref.	L [mm]	D [mm]	⊠	EAN
63-901	255	3,5	12/48	5907558405262

## Çeği dekarskie

Seaming pliers / Zange für Dachdecker / Клеци / Кліци дахарські / Falcsfogó 180° / Clește de tinichigerie / Pokrývačské kleště / Pokrývačské kliešte / Krovské klešče / Replės stogdengijai / Jumika knaibles / Plekikäärid / Ножница за ламаруна / Klijesta za krovopokrivače / Krovna klešta / Τανάλια / Alicates de techador / Pinza piegatrice / Tenaz / Pince de couvreur / Nijptang

**NEO TOOLS**



Ref.	L [mm]	W [mm]	⊠	EAN
31-070	275	60	5/25	5907558410785

**NEO TOOLS**



Ref.	L [mm]	W [mm]	⊠	EAN
31-075	275	60	5/25	5907558410792

**NEO TOOLS**



Ref.	L [mm]	W [mm]	⊠	EAN
31-080	275	60	5/25	5907558410808

## Nożyce do cięć kątowych

Angle shears / Winkelschere / Ножницы для резки под углом / Ножницы для косого різання / Szögben vágó olló / Foarfeca pentru tăieri unghiulare / Nůžky pro stříhání pod úhlem / Nožnice na kolmé strihanie / Škarje za rezanje profilov / Kampinio pjovimo žirkles / Škėres lenkiskai griešanai / Kalakäärid / Ножница за рязане под ъгъл / Škare za kutno sječenje / Makaze za sečenje uglova / Ψαλίδι φάλτσου / Tijeras de inglete / Cesoie per taglio angolare / Tesoura de corte em ângulo / Ciseaux pour coupe angulaire / Hoekschaar

**NEO TOOLS**



Ref.	⊠	EAN
01-260	8/32	5907558482034



## Szczypce tynkarskie

Rabbit pincers / Putzange / Клещи для штукатурных работ / Щипцы тинькарські / Rabitz fogó / Clește tencuială / Kleště omítkářské / Kliešte armovacie / Klešče za betonske armature / Replés tinkuotojui / Knipstangas / Harilikud tangid / Клещи керпеден / Armiračka Klijesta / Armiračka klesta / Πένσες οικοδομών / Tenaza rusa / Tenaglia a torre / Pinças para estuque / Pince de plătrage / Stukadoorstang

**NEO**  
TOOLS

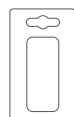

Ref.	L[mm]	⊠	EAN
01-160	250	6/48	5907558406047
01-162	300	6/36	5907558411744

**TOPEX**

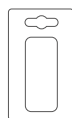

Ref.	L[mm]	⊠	EAN
32D541	250	6/60	5902062011534

**TOP TOOLS**



Ref.	L[mm]	⊠	EAN
32D141	250	6/60	5902062010674

## Imadło

Vice / Schraubstock / Тучку / Лецама / Satu / Menghinä / Svěrák / Zverák liatinový pevný / Primež / Spaustuvos / Kalts / Kruustangid / Меңгеме / Radionička stega / Mengele / Мэҥгевн / Tornillo de banco de precisión / Morsa girevole / Torno / Etau / Breekijzer

**NEO**  
TOOLS

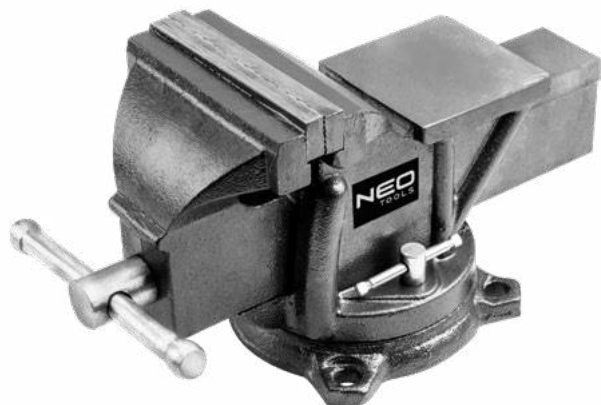

Ref.	W [mm]	Ra [mm]	⊠	EAN
35-010	100	108	0/2	5907558400762
35-012	125	124	0/2	5907558400779
35-015	150	147	0/1	5907558400786

**NEO**  
TOOLS

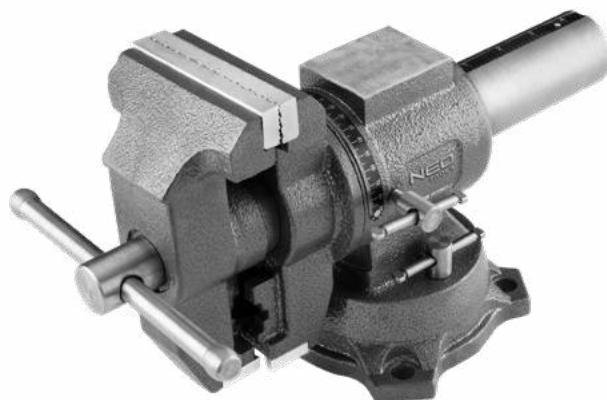

Ref.	W [mm]	Ra [mm]	⊠	EAN
35-030	100	100	0/1	5907558482683

**TOPEX**



Ref.	W [mm]	Ra [mm]	⊠	EAN
07A107	75	75	0/4	5902062043757
07A110	100	75	0/2	5902062040015
07A112	125	100	0/2	5902062040022
07A115	150	175	0/1	5902062040039
07A220	200	155	0/1	5902062997807

**TOPEX**

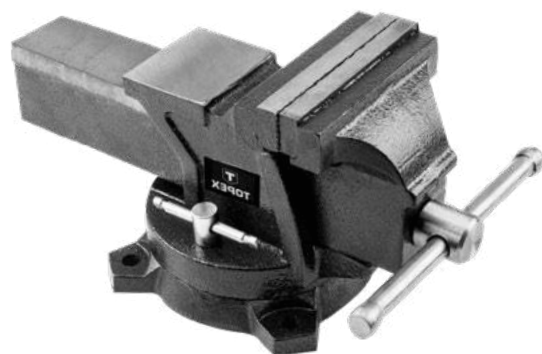

Ref.	W [mm]	Ra [mm]	⊠	EAN
07A210	100	75	0/2	5902062040046
07A212	125	105	0/2	5902062040053
07A215	150	140	0/1	5902062040060



## Imadło

Vice / Schraubstock / Tucku / Лещма / Satu / Menghinä / Svěrák / Zverák liatinový pevný / Primež / Spaustuvus / Kalts / Kruustangid / Межземе / Radionička stega / Mengersel / Mélyvevő / Tornillo de banco de precisión / Morsa girevole / Torno / Etau / Breekijzer

**NEO**  
TOOLS



Ref.	W [mm]	Ra [mm]	☒	EAN
35-026	70	53	0/24	5907558482690

**NEO**  
TOOLS

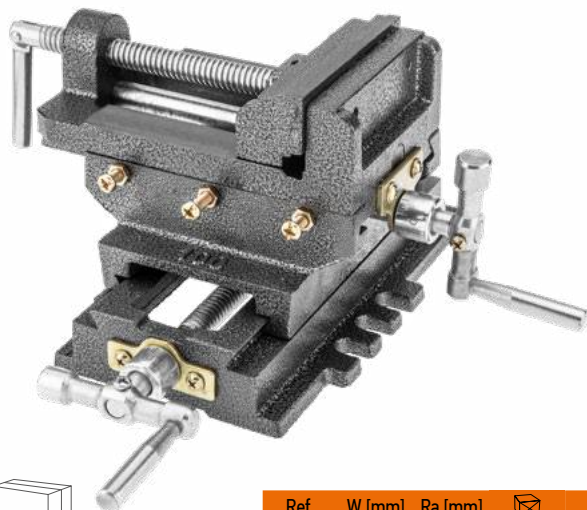

Ref.	W [mm]	Ra [mm]	☒	EAN
35-035	100	90	0/1	5907558482676

**NEO**  
TOOLS

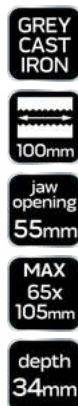
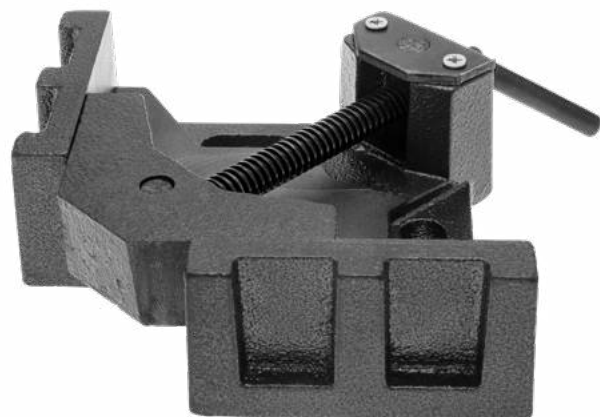

Ref.	W [mm]	Ra [mm]	☒	EAN
35-040	100	55	0/5	5907558482669

**TOPEX**



ALUMINIUM



Ref.	W [mm]	☒	EAN
07A307	57	0/18	5902062043863

**TOPEX**



ALUMINIUM



Ref.	W [mm]	Ra [mm]	☒	EAN
07A306	60	65	0/20	5902062043061

**TOPEX**



ALUMINIUM



Ref.	W [mm]	Ra [mm]	info	☒	EAN
07A310	100	95	możliwość mocowania do stołu	0/8	5902062043078

**TOP TOOLS**



Ref.	W [mm]	☒	EAN
07A206	60	0/10	5902062040077



## Przecinak

Chisel / Meißel / Зубило / Зубило / Laposvágó / Daltä / Sekáč / Sekáč / Dleto / Kírstukas / Cirtnis / Auguraud / Секач / Rezač / Σμίλη / Cortafrio / Scalpello / Cortador / Burin / Beitel

**NEO**  
TOOLS

**CrV**  
steel

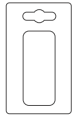

Ref.	L [mm]	W [mm]	☒	EAN
33-072	150	10	10/200	5907558413304
33-073	150	13	10/200	5907558413311
33-074	150	16	10/100	5907558413328

**NEO**  
TOOLS

**CrV**  
steel

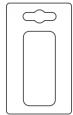

Ref.	L [mm]	ø [mm]	W [mm]	☒	EAN
33-081	300	18	22	6/24	5907558413144
33-082	300	18	35	6/24	5907558413151
33-083	300	18	50	6/24	5907558413168
33-084	300	20	75	6/24	5907558413175

## TOPEX



Ref.	L [mm]	W [mm]	ø [mm]	☒	EAN
03A136	300	23.5	16	0/24	5902062031075
03A139	300	27	19	0/24	5902062031525
03A149	400	27	19	0/20	5902062031532
03A159	500	27	19	0/15	5902062031556

## TOPEX

**CrV**  
steel



Ref.	L [mm]	ø [mm]	☒	EAN
03A170	300	19	6/36	5902062032072
03A171	300	25	6/24	5902062032089

## TOPEX

**CrV**  
steel



Ref.	L [mm]	W [mm]	☒	EAN
03A320	200	20	12/72	5902062272003
03A325	250	22.8	6/36	5902062272508

**TOP TOOLS**



Ref.	W [mm]	ø [mm]	☒	EAN
03A225	250	14	0/60	5902062030382
03A230	300	16	0/48	5902062030399
03A235	350	16	0/40	5902062030641

## Przebijak

Punch / Lochhammer / Зубило / Пробувач / Hegyvesdő / Preducea / Průbojník / Pribojník / Prebijač / Skyľmušys / Caurumsitis / Auguraud / Шило / Probijač / Probojac / Σμίλη / Puntero / Punzone con protezione / Saca-bocado / Perçoir / Puntslag

## TOPEX

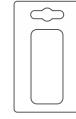

Ref.	L [mm]	ø [mm]	☒	EAN
03A169	400	19	0/20	5902062031563

## TOPEX

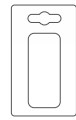

Ref.	L [mm]	ø [mm]	☒	EAN
03A180	300	19	4/24	5902062032096

**TOP TOOLS**



Ref.	W [mm]	ø [mm]	☒	EAN
03A245	250	14	0/60	5902062030405

## Wybijak

Pin punch / Austreiber / Зубило / Вибувач / Stiftkiütő / Matrijă de perforat / Vyrážeč / Vyrázač / Izbijač / Žymeklis (iškalimui) / Puansons / Auguraud / Избувач / Izbijač / Izbijač, prosekač / Σμίλη / Punzón / Punzone a punta / Chasse-goupille / Puntslag

**NEO**  
TOOLS

**CrV**  
steel

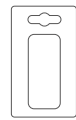

Ref.	L [mm]	ø [mm]	☒	EAN
33-066	150	3	100/200	5907558413250
33-067	150	4	100/200	5907558413267
33-068	150	5	100/200	5907558413274
33-069	150	6	100/200	5907558413281

## Punktak

Centre punch / Körner / Кернер / Кернер / Pontozó / Punctator / Důlčik / Razník / Točkaló / Žymeklis / Punktis / Augumárgisti / Керна / Ručni bušač / Obeleživač / Пóнта сáдpу / Punzón centrador / Punzone tondo / Punção / Pointeau / Doorslag

**NEO**  
TOOLS

**CrV**  
steel

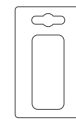

Ref.	L [mm]	ø [mm]	☒	EAN
33-063	120	6	10/200	5907558413229
33-064	120	8	10/200	5907558413236

## TOPEX

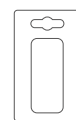

Ref.	L [mm]	ø [mm]	☒	EAN
03A441	100,0	6,3	25/100	5902062260147
03A442	127,5	9,4	25/100	5902062260383
03A445	152,0	12,7	25/100	5902062260123



## Zestaw wybijaaków i przecinaków

Pin punch and chisel set / Austreiber- und Meißel-Set / Набор пунсонов и зубил / Набор зубил / Vágókészlet / Set de poansoare și dălți / Sada vyrážačů a sekáčů / Súprava priebojníkov a sekačov / Komplet izbijačev in dlet / Kalimo kaltų ir kirstukų rinkinys / Ciljnu spiedņu un cirtņu komplekts / Tornide ja meislite komplekt / Комплект пунсонов и секачу / Set izbijača i rezača / Komplet izbijača i sekača / Σετ ζουμπάδων και σμιλών / Juego de punzones y cortadores / Punzoni e scalpelli / Kit de mnadris e cortadores / Jeu de chasse-goupilles et de burins / Set van puntslagen en knippers

NEO  
TOOLS

CrMo  
steel x5



Ref.	⊠	EAN
33-060	10/40	5907558407457

NEO  
TOOLS

CrV  
steel x6



Ref.	L [mm]	⊠	EAN
33-061	300	6/36	5907558413205

NEO  
TOOLS

CrV  
steel x12



Ref.	L [mm]	⊠	EAN
33-062	300	6/12	5907558413212

## Dobijaki do gwoździ

Nail punch set / Nageltreiber / Добойники для гвоздей / Пробивач для цвяхів, набір / Stiftkiiütő készlet / Set ciocane de găuri / Zatloukač hřebíků / Súprava priebojníkov / Žebřalník / Viniakalis / Punktstift naglām / Naelalõimiskomplekt / Замби / Probijači set / Probijac set / Ζουμπάς για καρφιά / Punzones para clavos / Punzoni per chiodi / Punção para cravar / Chasse-clous / Spijkerpons

TOPEX

x4



Ref.	Ø [mm]	⊠	EAN
03A440	0,8 - 3,2	12/72	5902062031396

## Lom

Wrecking bar / Brecheisen / Лом / Лом / Ládabontó / Rangő montare / Pácidlo / Pácidlo / Žebřalska babica / Laužtuvas / Lauznis / Kang / Косу крак / Poluga za čavle / Pajser / Λοστός / Palanca / Barra da demolição / Pé-de-cabra / Pied-de-biche / Breekijzer

NEO  
TOOLS



Ref.	L [mm]	⊠	EAN
29-040	460	1/5	5907558407327

NEO  
TOOLS



Ref.	L [mm]	Ø [mm]	⊠	EAN
29-041	400	16	0/5	5907558409529
29-061	600	19	0/5	5907558407310
29-091	900	19	5/5	5907558407327
29-092	1000	19	1/5	5907558409536

NEO  
TOOLS



Ref.	L [mm]	⊠	EAN
29-100	250	6/36	5907558463613

NEO  
TOOLS



Ref.	L [mm]	⊠	EAN
29-101	250	6/36	5907558463620

TOPEX



Ref.	L [mm]	Ø [mm]	⊠	EAN
04A130	300	21x10	0/20	5902062041302
04A140	400	21x11	0/20	5902062031068
04A160	600	29x16	0/10	5902062031129
04A175	750	30x16	0/10	5902062045041
04A190	900	30x16	0/10	5902062045058

TOPEX



Ref.	L [mm]	Ø [mm]	⊠	EAN
04A240	400	16	0/12	5902062045065
04A250	500	16	0/12	5902062045072
04A260	600	16	0/12	5902062030429
04A280	800	19	0/10	5902062031389
04A210	1000	18	0/10	5902062045089
04A212	1200	18	0/10	5902062045096



## Łom

Wrecking bar / Brecheisen / Лом / Лом / Ládabontó / Rangá montare / Páčidlo / Páčidlo / Žebljarska babica / Laužtuvas / Lauznis / Kang / Козу крак / Poluga za čavle / Pajser / Λοστός / Palanca / Barra da demolição / Pé-de-cabra / Pied-de-biche / Breekijzer

## TOPEX



Ref.	L [mm]	Ø [mm]	info	☒	EAN
04A312	1200	25	zėbrowany	0/1	5902062031280
04A315	1500	25	zėbrowany	0/1	5902062031297

## TOP TOOLS



Ref.	L [mm]	Ø [mm]	☒	EAN
04A234	400	13,5	0/12	5902062032331
04A236	600	13,5	0/12	5902062032348
04A239	900	15,5	0/12	5902062032355

## TOP TOOLS



Ref.	L [mm]	Ø [mm]	☒	EAN
04A230	300	13,5	0/30	5902062030481

## Wyciągacz do gwoździ

Wonder bar / Nadel-Auszieher / Гвоздодер / Цвяходер / Ládabontó / Dispozitiv de scos cuie / Ranga / Vytahovák hřebíků / Vytahovač klincov / Lomilka za žeblje / Viniatraukis / Naglu izvilcējs / Naelasōrg / Ключ козу крак / Izvlakač za čavle / Alatka za vađenje eksera / Προκοβήαλτης / Barra sacaclavos / Paranco a barra / Saca-pernos / Extracteur de clous / Spijkertrekker

## NEO TOOLS



Ref.	L [mm]	☒	EAN
29-030	380	0/5	5907558407310

## Pilniki do metalu

Steel file set / Metallfeilen / Напильники по металлу / Пилынок по металлу, набор / Reszelő készlet / Set tăietoare metal / Pilnik na kov / Súprava pilníkov / Konice za kovino / Dildés metalui / Vile metálam / Terasviilide komplekt / Пилу компл. / Турпија за метал set / Турпије за метал / Συλλογή λιμών για μέταλλο / Limas para metal / Set lime per metallo / Lima para metal / Lime à métal / Metaalvijlen

## NEO TOOLS



Ref.	L [mm]	☒	EAN
37-610	200	4/16	5907558407433

## Pilniki do metalu

Steel file set / Metallfeilen / Напильники по металлу / Пилынок по металлу, набор / Reszelő készlet / Set tăietoare metal / Pilnik na kov / Súprava pilníkov / Konice za kovino / Dildés metalui / Vile metálam / Terasviilide komplekt / Пилу компл. / Турпија за метал set / Турпије за метал / Συλλογή λιμών για μέταλλο / Limas para metal / Set lime per metallo / Lima para metal / Lime à métal / Metaalvijlen

## NEO TOOLS



Ref.	L [mm]	☒	EAN
37-022	200/2	10/80	5907558400847
37-122	200/2	10/80	5907558400939
37-222	200/2	10/80	5907558401028
37-322	200/2	10/80	5907558401110
37-422	200/2	10/80	5907558401202

## NEO TOOLS



Ref.	L [mm]	☒	EAN
37-605	200	4/16	5907558407426

## TOPEX



Ref.	L [mm]	info	☒	EAN
06A721	200/2	10/60	10/60	5902062101662
06A722	200/2	10/60	10/60	5902062101679
06A723	200/2	10/80	10/80	5902062101686
06A724	200/2	10/80	10/80	5902062101693
06A725	200/2	10/60	10/60	5902062101709

## TOPEX



Ref.	L [mm]	N	info	☒	EAN
06A130	200/2	x3	10/20	20/20	5902062102638
06A230	200/2	x3	10/20	10/20	5902062101099
06A250	200/2	x5	10/20	10/20	5902062101105

## TOP TOOLS



Ref.	L [mm]	☒	EAN
06A430	200	25/50	5902062100740





## Pilniki iglaki

Needle files / Igel-Pfeilen / Ηαδφύλυ / Ηανηλυκυ γοληαστυ / Túreszelő készlet / Mini-pile / Pilníky jehlové / Pilníky ihlové / Iglaste pile / Dildés, ylos / Adatvíles / Nöelviild / Велену нулу / Iglícaste turpije / Iglá turpije / Λίμες μονηλαμού / Limas de aguja / Set lime ad ago per metallo / Limas / Limes aiguilles / Naaldvijlen

### TOPEX



x6

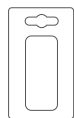

Ref.	L [mm]	Ø [mm]	☒	EAN
06A010	150	3	25/100	5902062610201

### TOPEX



x5

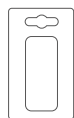

Ref.	L [mm]	Ø [mm]	☒	EAN
06A000	140	4,0	10/300	5902062103222

### TOPEX

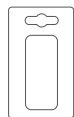

Ref.	L [mm]	Ø [mm]	info	☒	EAN
06A020	140	3	bez uchwyty	25/100	5902062610102
06A015	140	3	z uchwytem	25/100	5902062610157

### TOP TOOLS



x6

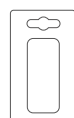

Ref.	☒	EAN
06A025	30/120	5902062100030

## Pilnik do drewna

Wood rasp / Holzfeile / Рашиуль по древу / Рашиуль / Faráspoly lapos / Raspel lemn / Pilník na drevo / Rašpla plochá / Konica za les / Dildés medžiui / Vile kokam / Puiduraspel / Пана / Турпија за дрво / Турпија за дрво / Ξύλινη ράσα / Lima para madera / Raspa per legno / Lima para madeira / Râpe à bois / Houtvijl

### NEO TOOLS

SUPER HARD  
T12  
steel

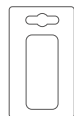

Ref.	L [mm]	☒	EAN
37-540	200	■	10/100 5907558401257
37-545	200	●	10/100 5907558401264
37-550	200	●	10/100 5907558401271

### NEO TOOLS

SUPER HARD  
T12  
steel

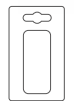

Ref.	L [mm]	☒	EAN
37-600	200	4/16	5907558407419

### TOPEX

T12

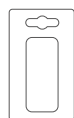

Ref.	L [mm]	info	☒	EAN
06A831	200	■	10/60	5902062101716
06A832	200	●	10/60	5902062101723
06A833	200	●	10/80	5902062101730

### TOPEX

x31

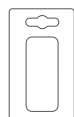

Ref.	L [mm]	☒	EAN
06A330	200	10/20	5902062101112

### TOP TOOLS

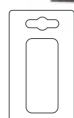

Ref.	L [mm]	☒	EAN
06A530	200	25/50	5902062100023



## Pilnik do ostrzenia łańcuchów

Chain sharpening file / Feile zum Kettenschärfen / Напильник для заточки цепи / Напильник для гостріння ланцюгів / Láncfűrészreszelő / Pile pentru ascuțirea lanțurilor / Pilník pro ostření pilových řetězů / Pilník na brúsenie reťazí / Brusilnik za verige / Pjūklų grandinių galandinimo dildė / Vřtle křezu asinžanai / Kettiteritusvillid / Пила за острене на вервцу / Турпија за оштрenje lanca / Турпије за оштрenje lanaca / Ακόνα αλυσίδας αλυσοπρίονου / Lima para afilar cadenas / Lima affilata per catena / Kettingvijl / Lima para afiar correntes

**TOPEX**

GCr15

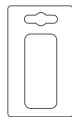

Ref.	L [mm]	Ø [mm]	☒	EAN
06A786	200	4,0	10/100	5902062103284
06A788	200	4,8	10/100	5902062103291

## Dłuta

Chisels / Beitel / Стамеску / Зубуна / Favésó készlet / Dalta / Dláta / Dláta / Dleta / Kaltai / Kalti / Peitlid / Дпема / Dlijeta / Dleta / Koniđia / Formones / Set scalpelli / Conjunto de Raspadores / Jeu de ciseaux / Beitels

**NEO TOOLS**



Ref.	☒	EAN
37-800	6/12	5907558485011

**NEO TOOLS**

x4

6 mm

12 mm

18 mm

24 mm

24 mm

24 mm

24 mm



Ref.	☒	EAN
37-900		5907558485110

**NEO TOOLS**



Ref.	W [mm]	☒	EAN
37-810	10	12/72	5907558485028
37-812	12	12/72	5907558485035
37-814	14	12/72	5907558485042
37-816	16	12/72	5907558485059
37-818	18	12/72	5907558485066
37-820	20	12/72	5907558485073
37-824	24	12/72	5907558485080
37-832	32	10/60	5907558485097
37-838	38	10/60	5907558485103

## Dłuta

Chisels / Beitel / Стамеску / Зубуна / Favésó készlet / Dalta / Dláta / Dláta / Dleta / Kaltai / Kalti / Peitlid / Дпема / Dlijeta / Dleta / Koniđia / Formones / Set scalpelli / Conjunto de Raspadores / Jeu de ciseaux / Beitels

**NEO TOOLS**

CrV steel



Ref.	W [mm]	☒	EAN
37-910	10		5907558485127
37-912	12		5907558485134
37-914	14		5907558485141
37-916	16		5907558485158
37-918	18		5907558485165
37-920	20		5907558485172
37-924	24		5907558485189
37-932	32		5907558485196

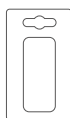

## Dłuta

Chisels / Beitel / Стамеску / Зубуна / Favésó készlet / Dalta / Dláta / Dláta / Dleta / Kaltai / Kalti / Peitlid / Дпема / Dlijeta / Dleta / Koniđia / Formones / Set scalpelli / Conjunto de Raspadores / Jeu de ciseaux / Beitels

**TOPEX**



Ref.	W [mm]	☒	EAN
09A106	6	12/120	5902062101129
09A108	8	12/120	5902062101136
09A110	10	12/120	5902062101143
09A112	12	12/120	5902062101150
09A114	14	12/120	5902062101167
09A115	15	0/120	5902062101174
09A116	16	12/120	5902062101181
09A118	18	12/96	5902062101198
09A120	20	12/96	5902062101204
09A122	22	12/72	5902062101211
09A125	25	12/72	5902062101228
09A132	32	12/72	5902062101235
09A138	38	0/48	5902062101242

**TOPEX**

CrV



Ref.	W [mm]	☒	EAN
09A410	10	6/48	5902062102959
09A412	12	6/48	5902062102966
09A414	14	6/48	5902062102973
09A416	16	6/48	5902062102980
09A420	20	6/48	5902062102997
09A425	25	6/48	5902062103000
09A432	32	6/48	5902062103017

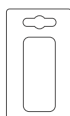

**TOPEX**

x4



Ref.	W [mm]	☒	EAN
09A310	6, 12, 18, 24	5/30	5902062102874

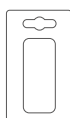

## Dłuta

Chisels / Beitel / Стамески / Зубуна / Favésó készlet / Dalta / Dláta / Dláta / Dleta / Kaltai / Kalti / Peitlid / Днена / Dlijeta / Dleta / Koničia / Formones / Set scalpelli / Conjunto de Raspadores / Jeu de ciseaux / Beitel

**TOP TOOLS**

x4

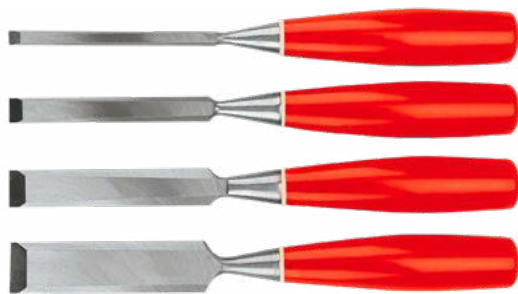

Ref.	W [mm]	☒	EAN
09A322	6, 12, 18, 24	0/40	5902062104434

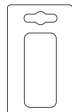

**TOP TOOLS**

x4



Ref.	W [mm]	☒	EAN
09A320	6, 12, 18, 24	0/36	5902062100092

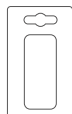

## Ścisk automatyczny

Quick clamp / Automatizkzwing / Струбцина автоматическая / Струбцина столярна / Kézi szorító / Clemă cu acțiune rapidă / Automatická svorka / Zvierka automatická / Avtomatska spona / Spaustuvas / Spiles automātiskās / Kiirklamber / Стяга / Stolarska stega / Stolarska stega / Σφιγκτήρας ελασπίου / Sargento automático / Morsetto rapido / Grampo automático / Serre-joint automatique / Automatische klemmen

**NEO TOOLS**

2 functions  
▶◀ / ▶◀  
HEAVY DUTY

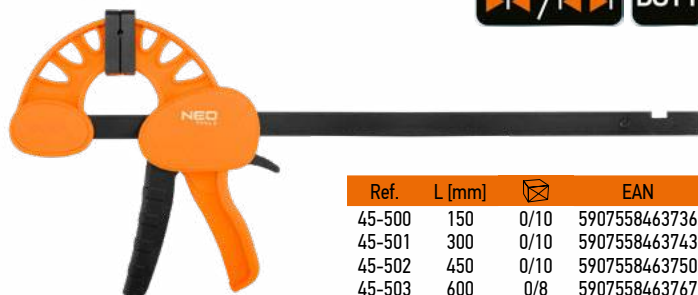

Ref.	L [mm]	☒	EAN
45-500	150	0/10	5907558463736
45-501	300	0/10	5907558463743
45-502	450	0/10	5907558463750
45-503	600	0/8	5907558463767
45-504	750	0/8	5907558463774
45-505	900	0/8	5907558463781

**TOPEX**



Ref.	L [mm]	W [mm]	☒	EAN
12A515	150	60	6/24	5902062125156
12A520	200	60	6/24	5902062125200
12A530	300	60	5/30	5902062125309
12A545	450	60	6/12	5902062125453
12A560	600	60	6/12	5902062125606
12A575	750	60	6/12	5902062125750
12A590	900	60	5/10	5902062125903

## Ścisk stolarski

F-clamp / Schraubzwinde / Струбцина столярная / Струбцина столярна / Gyorscsavaszorító / Clemă în forma F / Truhlářská svorka / Zvierka stolárska / Mizarska spona / Spaustuvas stalii / Spiles galdnieka / F-klamber / Стяга / Stolarska stega / Stolarska stega / Σφιγκτήρας ξυλουργού / Sargento / Morsetto a F / Grampo de marcenaria / Serre-joint de menuisier / Timmermansklemmen

**NEO TOOLS**



Ref.	L [mm]	W [mm]	☒	EAN
45-220	200	120	2/6	5907558435481
45-230	300	120	2/6	5907558435498
45-240	400	120	2/6	5907558435504

**NEO TOOLS**



ERGONOMIC  
bi-material  
handle

Ref.	L [mm]	W [mm]	☒	EAN
45-450	150	50	0/20	5902062062796
45-451	250	50	0/20	5902062062802
45-452	300	80	0/10	5902062062819
45-453	300	120	0/10	5902062062826
45-454	500	120	0/10	5902062062833
45-455	800	120	0/6	5902062062840
45-456	1000	120	0/6	5902062062857
45-457	1500	120	0/4	5902062062864

**TOPEX**

DIN  
5117

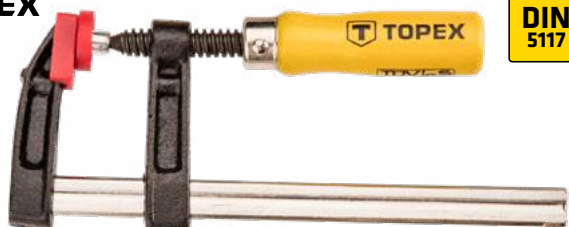

Ref.	L [mm]	W [mm]	☒	EAN
12A100	150	50	0/25	5902062102928
12A102	250	50	0/25	5902062102935
12A120	300	80	0/25	5902062102799
12A123	300	120	0/10	5902062102805
12A125	500	120	0/10	5902062102812
12A128	800	120	0/6	5902062102829
12A130	1000	120	0/6	5902062102836
12A135	1500	120	0/6	5902062102904

**TOP TOOLS**

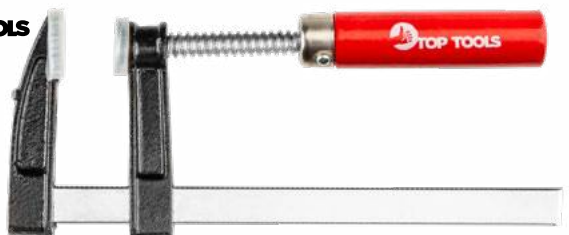

Ref.	L [mm]	W [mm]	info	☒	EAN
12A200	150	50		0/50	5902062100467
12A215	150	50	× 2	0/25	5902062100504
12A201	200	50		0/50	5902062100474
12A216	200	50	× 2	0/25	5902062100511
12A202	250	50		0/50	5902062100481
12A203	300	50		0/50	5902062100498
12A220	300	80		0/25	5902062100528
12A223	300	120		0/20	5902062100535
12A225	500	120		0/10	5902062100542
12A228	800	120		0/6	5902062100559



## Šcisk narožnikowy

Agle clamp / Winkelzwinge / Струбцина угловая / Струбцина нарижна / Sarokszorító / Clemă unghiulară / Rohová spojka / Zvierka rohová / Kotna spona / Gnybtai kampiniai / Spiles stūra / Nurgaklamber / Стяга ъглова / Kutna stega / Ugaona stega / Γωνιακός σφιγκτήρας / Tornillo de banco de esquina / Morsetto angolare / Grampo de canto / Serre-joint angulaire / Hoekklemmen

NEO  
TOOLS



Ref.	L [mm]	W [mm]	☒	EAN
45-490	95	70	0/20	5907558463712

NEO  
TOOLS



Ref.	L [mm]	W [mm]	☒	EAN
45-491	75	70	0/20	5907558463729

TOPEX



ALUMINIUM



Ref.	L [mm]	W [mm]	☒	EAN
12A300	65	70	0/14	5902062705259

TOP TOOLS



Ref.	L [mm]	W [mm]	☒	EAN
12A305	75	75	10/80	5902062101082

## Šcisk tašmowy

Belt clamp / Bandzwinge / Струбцина ленточная / Струбцина стрічкова / Parketta összehúzó / Sistem rulant cleme / Pásová svarka / Zvierka rámková / Jermenska spona / Spraustuvos juostinis / Spiles lentveida / Rihmaklamber / Стяга лентова / Stega rojas / Stega rojas / Σφιγκτήρας λωρίδας / Prensa de cinta / Morsetto a nastro / Grampo de fita / Serre-joint à bande / Bandklemmen

NEO  
TOOLS



Ref.	L [m]	W [mm]	☒	EAN
45-493	4	26	0/50	5907558463897

TOPEX

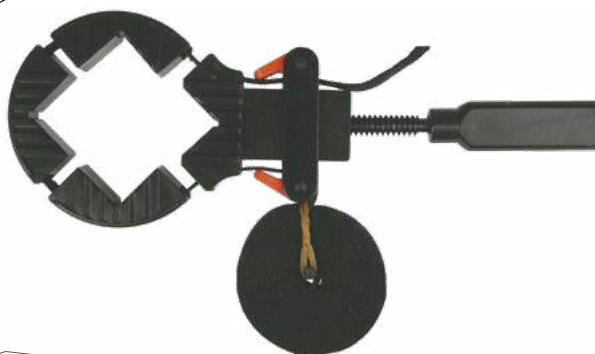

Ref.	L [m]	W [mm]	D [mm]	☒	EAN
12A340	4	25	1	0/20	5902062102300

TOPEX

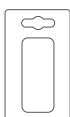
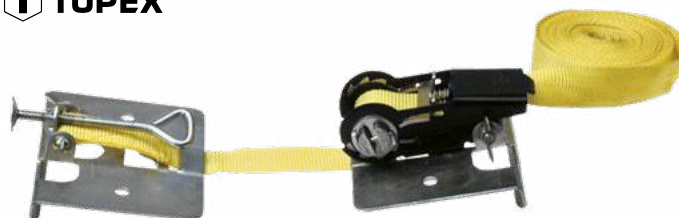

Ref.	L [m]	W [mm]	D [mm]	☒	EAN
12A350	5	25	1	10/20	5902062102898

## Šcisk nylonowy

Nylon quick clamp / Nylon-Schraubenzwinge / Струбцина нейлоновая / Струбцина нейлонова / Kézi szorító / Menghină de nylon / Svarka nylonová / Zvierka nylonová / Najlonska spona / Plastmasiniai sprauštai / Neilona spiles / Nailonpitskruvi / Наїлонова менгеме / Najlonska stezaljka / Najlonski stezači / Σφιγκτήρας πλαστικός / Prensa en "C" de nilón / Morsetto Nylon / Grampo de nylon / Serre-joint nylon / Nylon klemmen

TOPEX



Ref.	L [mm]	☒	EAN
12A380	50	24/144	5902062123800
12A382	75	8/48	5902062123824
12A384	100	8/48	5902062123848



## Ścisk sprężynowy

Spring clamp / Federzwinge / Зажим пружинный / Затискач пружинный / Szorítócsipesz / Borná elastică / Pružinová svorka / Zvierka / Natezna spona / Grybtaï spyruokliniai / Spiles / Vedrukklamber / Стяга / Stega / Stega special / Σφιγκτήρας ελατρίων / Sargento / Morsetto a scatto / Grampo de mola / Serre-joint à ressort / Veerklemmen

NEO  
TOOLS



HEAVY  
DUTY

Ref.	L [mm]	☒	EAN
45-520	50	0/60	5907558463798
45-521	65	0/100	5907558463804
45-522	75	0/48	5907558463811
45-523	100	0/50	5907558463828

NEO  
TOOLS



ERGONOMIC  
TPR  
HANDLE

Ref.	L [mm]	☒	EAN
45-530	75	100/400	5907558463835
45-531	100	40/240	5907558463842
45-532	150	20/120	5907558463859
45-533	220	20/80	5907558463866

TOP TOOLS



Ref.	L [mm]	☒	EAN
12A410	100	0/250	5902062102317
12A415	150	0/100	5902062102324
12A422	225	0/100	5902062102331

## Ściski modelarskie

G clamps / Klemmlänge / Трубцины / Трубцина мініатюрна / Sarokszorító / Menghine de modelari, tip G / Svorky modelářské / Modelárske zvierky / Modelarske spona / Spaustai modeliavimui / Modelēšanas spiles / G-pitskruid / Менгеме за моделципу / Rezbarske stezaljke / Modelarski stezači / Σφιγκτήρας μοντελισμού / Prensas en „C” / Morsetto angolare / Grampos p. Modelação / Serre-joint de modelage / G-klemmen

TOP TOOLS



x3

Ref.	L [mm]	☒	EAN
12A375	25, 50, 75	0/30	5902062102720

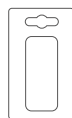

## Ścisk rurowy

Pipe clamp / Rohrklemme / Трубчатый зажим / Трубчатий затискач / Csöves szorító / Dispozitiv de presare pentru țevi / Trubková svorka / Růrková svorka / Objemka za cevi / Vamzdžio spaustukas / Caurules skava / Torukklamber / Сноба за тръби / Stezaljka za cijev / Стезалъна за цев / Σφιγκτήρας σωλήνα / Abrazadera de tubo / Morsetto a tubo / Braçadeira de tubo / Collier de serrage

UNIVERSAL  
LENGHT

LARGE  
CLAMPING  
SURFACE

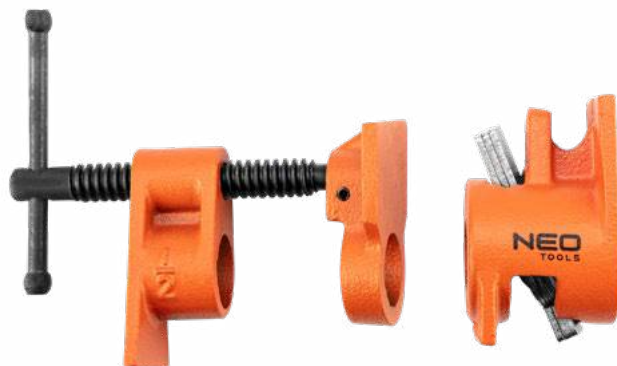

Ref.	Info	☒	EAN
45-495	1/2"	0/18	5907558463873
45-496	3/4"	0/18	5907558463880



# Kielnia

Brick trowel / Kelle / Кельма / Кельня / Sarokkanál / Mistrie / Zednická lžice / Kefňa murárska / Zidarska lopatica / Mentelè / Kelle / Müürikellu / Мучпура 200mm / Žlica zidarska / Mistrija zidarska / Мушті / Paleta de albañil / Cazuola / Colher de pedreiro / Truelle / Troffel

**NEO**  
TOOLS



Ref.	L [mm]	W [mm]	⊠	EAN
50-121	140	80	0/50	5907558438925

**NEO**  
TOOLS



Ref.	L [mm]	W [mm]	⊠	EAN
50-122	165	54	0/50	5907558438932
50-123	165	54	0/50	5907558438949

**NEO**  
TOOLS



Ref.	L [mm]	⊠	EAN
50-101	180	0/50	5907558438352
50-102	200	0/50	5907558438369

**NEO**  
TOOLS



Ref.	L [mm]	⊠	EAN
50-141	140	0/50	5907558438253
50-142	160	0/50	5907558438260
50-143	180	0/25	5907558438277

**NEO**  
TOOLS



Ref.	L [mm]	⊠	EAN
50-131	60	0/50	5907558438178
50-132	80	0/50	5907558438185
50-133	100	0/50	5907558438192
50-134	120	0/50	5907558438208

**NEO**  
TOOLS



Ref.	L [mm]	⊠	EAN
50-111	8	0/50	5907558438376
50-112	10	0/50	5907558438383
50-113	12	0/50	5907558438390

**NEO**  
TOOLS



Ref.	L [mm]	⊠	EAN
50-146	140	0/50	5907558438284
50-147	160	0/50	5907558438291
50-148	180	0/25	5907558438307

**NEO**  
TOOLS



Ref.	L [mm]	⊠	EAN
50-136	60	0/50	5907558438215
50-137	80	0/50	5907558438222
50-138	100	0/50	5907558438239
50-139	120	0/50	5907558438246

**NEO**  
TOOLS



Ref.	L [mm]	⊠	EAN
50-155	80	0/50	5907558438338
50-156	80	0/50	5907558438345



# Kielnia

Brick trowel / Kelle / Кельма / Кельня / Sarokkanál / Mistrie / Zednická lžice / Kefňa murárska / Zidarska lopatica / Mentelè / Kelle / Müürikellu / Мучпуя 200mm / Žlica zidarska / Mistrinja zidarska / Муотпи / Paleta de albañil / Cazzuola / Colher de pedreiro / Truelle / Troffel

**TOPEX**

STAINLESS  
STEEL



Ref.	L [mm]	W [mm]	⊠	EAN
13A100	180	180	6/60	5902062091918

**TOPEX**



Ref.	L [mm]	W [mm]	⊠	EAN
13A119	200	140	12/60	5902062092380

**TOPEX**



Ref.	L [mm]	W [mm]	⊠	EAN
13A800	160	80	0/30	5902062091635

**TOPEX**



Ref.	L [mm]	W [mm]	⊠	EAN
13A587	140	80	0/30	5902062048622
13A588	160	20	0/30	5902062048639

**TOPEX**



STAINLESS  
STEEL

Ref.	L [mm]	W [mm]	⊠	EAN
13A805	100	60	0/30	5902062091642
13A810	110	80	0/30	5902062091659

**TOPEX**

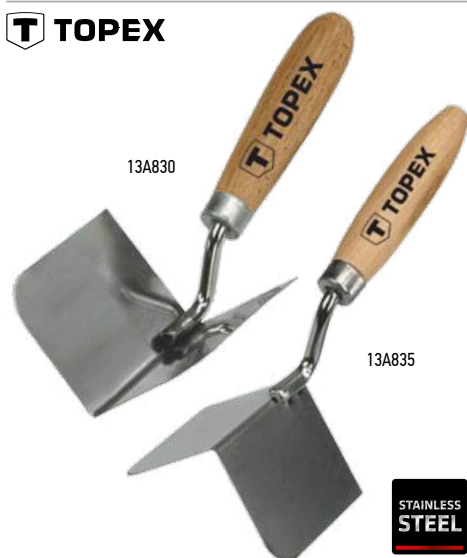

Ref.	L [mm]	W [mm]	⊠	EAN
13A830	80	60	0/50	5902062091697
13A835	80	60	0/50	5902062091703

**TOP TOOLS**



Ref.	L [mm]	⊠	EAN
13A102	200x175	0/120	5902062090447



## Paca

Float / Reibbrett / Терка / Терка / Acélsimító / Lopátičá / Hladitko / Hladitka nerez / Gladilna žlica / Glaistýklé / Rívdélis / Ujuk / Манамашка / Gleter / Perdaska / Трибілі / Talocha / Frattazzo / Desempenadeira / Taloche / Hoektraffel

**NEO**  
TOOLS



**PVC**

Ergonomic  
beechen handle

Ref.	L [mm]	W [mm]	☒	EAN
50-209	270	130	0/10	5907558438666

**NEO**  
TOOLS



**6 YEARS**  
GUARANTEE

STAINLESS  
steel

Ergonomic  
beechen handle

Ref.	L [mm]	W [mm]	☒	EAN
50-201	270	125	0/24	5907558438574

**NEO**  
TOOLS



**6 YEARS**  
GUARANTEE

STAINLESS  
steel

Ergonomic  
beechen handle

Ref.	L [mm]	W [mm]	☒	EAN
50-161	270	128	0/24	5907558438406

**NEO**  
TOOLS



**6 YEARS**  
GUARANTEE

STAINLESS  
steel

Ergonomic  
bi-material handle

Ref.	L [mm]	W [mm]	☒	EAN
50-166	270	128	0/24	5907558438444

**NEO**  
TOOLS



**6 YEARS**  
GUARANTEE

STAINLESS  
steel

Ergonomic  
bi-material handle

Ref.	L [mm]	W [mm]	☒	EAN
50-160	270	97x80	0/20	5907558438963

**NEO**  
TOOLS



**6 YEARS**  
GUARANTEE

STAINLESS  
steel

Ergonomic  
beechen handle

Ref.	L [mm]	W [mm]	☒	EAN
50-171	380	128	0/10	5907558438482
50-181	480	128	0/10	5907558438529
50-191	580	128	0/18	5907558438550
50-196	680	128	0/18	5907558438567

**TOPEX**



STAINLESS  
STEEL

Ref.	L [mm]	W [mm]	☒	EAN
13A228	280	130	0/30	5902062090478

**TOPEX**



**6 YEARS**  
GUARANTEE

Ref.	L [mm]	W [mm]	☒	EAN
08A115	210	105	0/30	5902062091154

**TOPEX**



Ref.	L [mm]	W [mm]	info	☒	EAN
13A340	260	130	gładka	0/24	5902062091093

**TOPEX**

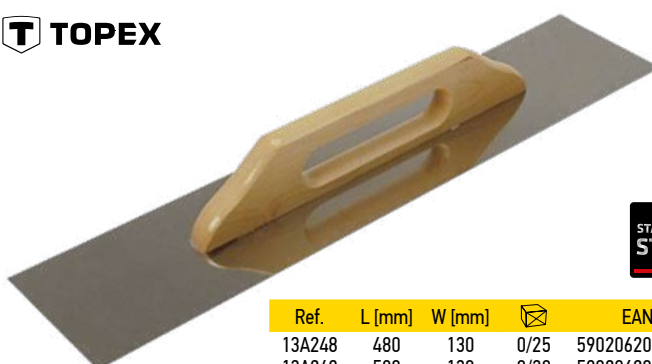

STAINLESS  
STEEL

Ref.	L [mm]	W [mm]	☒	EAN
13A248	480	130	0/25	5902062091086
13A249	580	130	0/30	5902062092250
13A250	680	130	0/30	5902062092267





## Paca z zębami

Serrated float / Reibebrett mit Zähnen / Терка с зубьями / Терка зубчаста / Acélsimító rozsdamentes / Drisčá cu dinți / Hladitko zub / Hladidlo so zubami / Gladilka z zobmi / Dantyta trintuvé / Rive ar zobiem / Hammaskellu / Назъбена маламашка / Zupčasti plovlak / Glačalica sa zubima / Σπάτουλα χτένα / Talocha con peine / Frattazzo / Desempenadeira com dentes / Taloché à dents / Plakspaan met vertanding

**NEO**  
TOOLS



**NEO**  
TOOLS



Ref.	L [mm]	W [mm]	a x b x c [mm]	☒	EAN
50-162	270	128	6 x 6 x 6	0/24	5907558438413
50-163	270	128	8 x 8 x 8	0/24	5907558438420
50-164	270	128	10 x 10 x 10	0/24	5907558438437

Ref.	L [mm]	W [mm]	a x b x c [mm]	☒	EAN
50-167	270	128	6 x 6 x 6	0/24	5907558438451
50-168	270	128	8 x 8 x 8	0/24	5907558438468
50-169	270	128	10 x 10 x 10	0/24	5907558438475

**NEO**  
TOOLS



**NEO**  
TOOLS

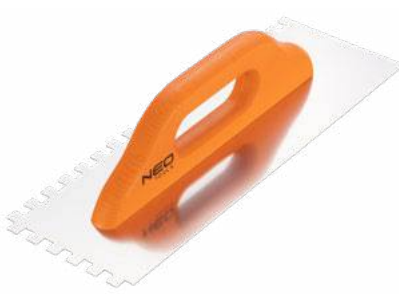

Ref.	L [mm]	W [mm]	a x b x c [mm]	☒	EAN
50-203	270	125	8 x 8 x 8	0/24	5907558438598
50-204	270	125	6 x 6 x 6	0/24	5907558438611
50-205	270	125	4 x 4 x 4	0/24	5907558438710
50-202	270	125	10 x 10 x 10	0/24	5907558438581

Ref.	L [mm]	W [mm]	a x b x c [mm]	☒	EAN
50-172	380	128	6 x 6 x 6	0/10	5907558438499
50-173	380	128	8 x 8 x 8	0/10	5907558438505
50-174	380	128	10 x 10 x 10	0/10	5907558438512
50-182	480	128	8 x 8 x 8	0/10	5907558438536
50-183	480	128	10 x 10 x 10	0/10	5907558438543

**T TOPEX**

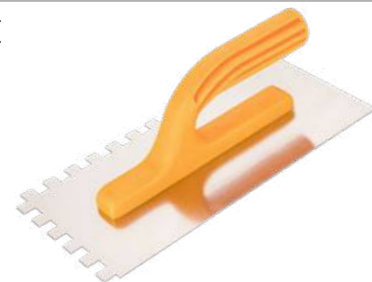

## Paca z gąbką

Float with sponge / Reibebrett mit Schwamm / Терка с губкой / Терка з губкою / Szivacsos simító / Drisčá cu burete / Hladitko s houbou / Hladidlo so špongiou / Gladilka z gobo / Trintuvé su kempine / Rive ar súkli / Käsnağa kellu / Маламашка с зъба / Plovak sa spužvom / Glačalica sa sunderom / Σπάτουλα φινιρίσματος με σπόγγο / Llana con esponja / Frattazzo / Desempenadeira com esponja / Taloché à éponge / Plakspaan met spons

Ref.	L [mm]	W [mm]	a x b x c [mm]	☒	EAN
13A284	280	130	4 x 4 x 4	0/30	5902062090485
13A286	280	130	6 x 6 x 6	10/30	5902062090492
13A288	280	130	8 x 8 x 8	0/30	5902062090508
13A290	280	130	10x10x10	0/30	5902062090515

**NEO**  
TOOLS



Ref.	L [mm]	W [mm]	float [mm]	☒	EAN
50-224	280	140	30	0/10	5907558438703

## Paca styropianowa

Polystyren float / Styroporreibbrett / Терка пенополистироловая / Терка полістирольна / Simító hungarocell / Lopičiča polistiren / Polystyrenové hladitko / Hladitko polystyrénové / Gladilna žlica za stiropor / Trintuvé glaištiv / Rīvdēlis putuplasta / Ujuk (poliüstireen) / Маламашка / Gladilo / Perdaska / Τριβίδι από πολυεστέρα / Talocha de polièstireno / Frattazzo / Desempenadeira de polièstireno extruído / Taloché polystyrène / Polystyren troffel

**NEO**  
TOOLS

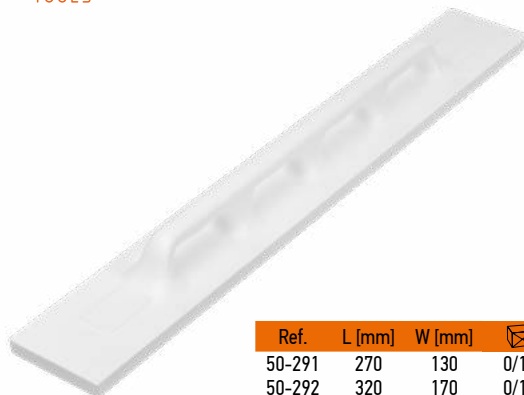

Ref.	L [mm]	W [mm]	☒	EAN
50-291	270	130	0/10	5907558438635
50-292	320	170	0/10	5907558438826
50-293	500	140	0/10	5907558438697
50-294	600	130	0/10	5907558438734
50-295	700	140	0/10	5907558438864

**NEO**  
TOOLS



Ref.	L [mm]	W [mm]	float [mm]	☒	EAN
50-226	280	140	25	0/10	5907558438840

**NEO**  
TOOLS



Ref.	L [mm]	W [mm]	float SMPX [mm]	☒	EAN
50-225	280	140	25	0/10	5907558438789



## Paca z gąbką hydrochlonna

Float with special sponge / Reibebrett mit Schramm wasseraufsaugend / Терка влазопоглощающей губкой / Тертка з гігроскопічною губкою / Műanyag simító / Driščă cu burete hidroabsorbant / Hladítko s hydroabsorbční houbou / Hladidlo hydro mlátan / Gladilka z vodovpojno gobo / Trintuvé su vanderj sugeriančia kempine / Rive ar mitrumu uszúcsóú sükli / Vettimava käsnağa kellu / Маламашка с влазопогльщаща гъба / Plovak s hidroklorom spružvom / Glačalica sa upijajućim sunderom / Σπάτουλα φινιρίματος με απορροφητικό σπόγγο / Talocha de plástico con esponja hidroabsorbente / Frattazzo / Desempenadeira com esponja absorvente / Taloché à éponge avide d'eau / Plakspraak met absorberende spons

NEO  
TOOLS



TOPEX



Ref.	L [mm]	W [mm]	float [mm]	☒	EAN
50-223	280	140	30	0/10	5907558438703

Ref.	L [mm]	W [mm]	☒	EAN
13A338	260	130	0/20	5902062092199

## Paca z gąbką gęstą

Float with dense sponge / Reibebrett mit Schramm dick / Терка с плотной губкой / Тертка зі щільною губкою / Műanyag simító / Driščă cu burete dens / Hladítko s hustou houbou / Hladidlo so špongiou husté / Gladilka z gosto gobo / Trintuvé su tankios tekstūros kempine / Rive ar blīvu sükli / Tiheda käsnağa kellu / Маламашка с гъста гъба / Plovak s gustom spružvom / Glačalica sa gustim sunderom / Σπάτουλα φινιρίματος με συμπαγή σπόγγο / Talocha de plástico con esponja densa / Frattazzo / Desempenadeira com esponja densa / Taloché à éponge dense / Plakspraak met dichte spons

NEO  
TOOLS



TOPEX



Ref.	L [mm]	W [mm]	float [mm]	☒	EAN
50-221	280	140	25	0/10	5907558438659

Ref.	L [mm]	W [mm]	info	☒	EAN
13A336	260	130	gąbka gęsta	0/20	5902062092182

## Paca z gąbką gumową

Float with rubber sponge / Reibebrett mit Gummischwamm / Терка с резиновой губкой / Тертка з гумовою губкою / Műanyag simító / Driščă cu burete de cauciuc / Hladítko s pryžovou houbou / Hladidlo so špongiou gumové / Gladilka z gumijasto gobo / Trintuvé su gumine kempine / Rive ar gumijas sükli / Kummikäsnağa kellu / Маламашка с гумена гъба / Plovak s gumenot spružvom / Glačalica sa gumenim sunderom / Σπάτουλα φινιρίματος με ελαστικό σπόγγο / Talocha de plástico con esponja de goma / Frattazzo / Desempenadeira com esponja de borracha / Taloché à éponge en caoutchouc / Plakspraak met rubberen spons

NEO  
TOOLS



TOPEX



Ref.	L [mm]	W [mm]	float [mm]	☒	EAN
50-222	280	140	18	0/10	5907558438673

Ref.	L [mm]	W [mm]	float [mm]	☒	EAN
13A342	260	120	18	0/20	5902062092304

## Paca z gąbką miękką

Float with soft sponge / Reibebrett mit Schramm weich / Терка с мягкой губкой / Тертка з м'якою губкою / Műanyag simító / Driščă cu burete moale / Hladítko s měkkou houbou / Hladidlo so špongiou jemné / Gladilka z mehko gobo / Trintuvé su minkšta kempine / Rive ar mīksto sükli / Pehme käsnağa kellu / Маламашка с мекка гъба / Plovak s mekom spružvom / Glačalica sa mekim sunderom / Σπάτουλα φινιρίματος με μαλακό σπόγγο / Llana con esponja dura / Frattazzo / Desempenadeira com esponja mole / Taloché à éponge molle / Plakspraak met zachte spons

TOPEX



Ref.	L [mm]	W [mm]	info	☒	EAN
13A334	260	130	gąbka miękka	0/20	5902062092175

## Paca z gąbką twardą

Float with hard sponge / Reibebrett mit Schramm hart / Терка с твердой губкой / Тертка з жорсткою губкою / Műanyag simító / Driščă cu burete dur / Hladítko s tvrdou houbou / Hladidlo so špongiou tvrdé / Gladilka s trdo gobo / Trintuvé su kieta kempine / Rive ar cietu sükli / Kōva käsnağa kellu / Маламашка с твърда гъба / Plovak s tvrdom spružvom / Glačalica sa tvrdim sunderom / Σπάτουλα φινιρίματος με σκληρό σπόγγο / Llana con esponja blanda / Frattazzo / Desempenadeira com esponja dura / Taloché à éponge dure / Plakspraak met harde spons

TOPEX



Ref.	L [mm]	W [mm]	info	☒	EAN
13A332	260	130	gąbka twarda	0/20	5902062092188



## Paca z gumą

Float with rubber / Reibebrett mit Gummi / Терка с резиновым покрытием / Тертка з гумою / Gumis simító / Drščica cu cauciuc / Hladitko s pryží / Hladidlo s gumou / Gladilka z gumo / Gumuota trintuvė / Rive ar gumiju / Kummiga kellu / Гумена маламашка / Plovak s gumot / Glačalica s gumot / Σπάτουλα φινιρίσματος με λάστιχο / Llana con goma / Frattazzo / Desempenadeira com borracha / Taloche à caoutchouc / Plakspaan met rubber

NEO  
TOOLS



Ref.	L [mm]	W [mm]	float [mm]	☒	EAN
50-232	280	140	4	0/10	5907558438796
50-231	280	140	8	0/10	5907558438628

## Paca z filcem

Float with felt / Reibebrett mit Filz / Терка с войлочным покрытием / Тертка з поєстю / Múanyag simító / Drščica cu pãslã / Hladitko s filcem / Hladidlo s filcom / Gladilka s filcem / Trintuvė su dirbtiniu veltniu / Rive ar tãbu / Fliisiga kellu / маламашка с филц / Plovak s filcom / Glačalica sa filcom / Σπάτουλα φινιρίσματος με κετσέ / Taloche con feltro / Frattazzo / Desempenadeira com feltro / Taloche à feutre / Plakspaan met vilt

NEO  
TOOLS



Ref.	L [mm]	W [mm]	float [mm]	☒	EAN
50-241	280	140	8	0/10	5907558438857

TOPEX



Ref.	L [mm]	W [mm]	grubość [mm]	info	☒	EAN
13A320	260	130	8	guma	0/14	5902062090539
13A321	260	130	4	guma	0/30	5902062208323

## Filc do pacy

Masonry felt / Filz für Reibebrett / Накладка войлочная для терки / Поєсть до тертки / Filc simítóhoz / Pãslã de drščicã / Plst' pro hladitko / Filc do hladidla / Filc za gladilko / Dirbtinis veltnis trintuvei / Sãkļa tãba / Fliis kellule / Филц за маламашка / Filc za plovak / Filc za rad / Σρώμα κετσέ για σπάτουλα φινιρίσματος / Feltro para llana / Feltro per frattazzo / Feltro para desempenadeira / Feutre pour taloche / Vilt voor truffel

NEO  
TOOLS



Ref.	L [mm]	W [mm]	float [mm]	☒	EAN
50-262	280	140	8	0/50	5907558438918

## Zestaw glazurniczy

Glazing kit / Set zum Fliesenverlegen / Набор плиточника / Набор до укладання нахлїв / Burkoló készlet / Garniturã de glazurare / Sada na obklady / Glazúrovacia súprava / Komplet za peçarje / Rinkinys plyteliu klijavimui / Fližu licēja komplekts / Plaatimiskomplekt / Комплект за гледжосване / Set za glazuru / Pribor za glaziranje / Σετ για τοποθέτηση πλακιδίων / Juego para colocar azulejos / Set piastrellista / Kit gp. Azulejos / Jeu d'outils de carrelage / Glazuurset

NEO  
TOOLS



NEO  
TOOLS



Ref.	☒	EAN
50-253	0/1	5907558438741

Ref.	☒	EAN
50-254	0/1	5907558465037



## Gąbka porowata

Porous sponge / Schwamm, porös / Губка пористая мягкая / Губка пориста / Szivacsokocsa / Burete poros / Pórovitá houba / Pórovitá špongia / Goba s porami / Koréta kempiné / Porainais süklis / Poorne käsn / Порцеста гъба / Spružna s porama / Šuprljikav sunder / Σπόγγος μαλακός πορώδης / Esponja con poros / Spugna soffice / Esponja com poros / Mousse poreuse / Poreus spons

**NEO**  
TOOLS



50-282



50-281

Ref.	L [mm]	W [mm]	H [mm]	info	☒	EAN
50-281	140	110	70	absorptive	0/100	5907558438819
50-282	165	100	60	soft	0/100	5907558438772

## Czerpak murarski

Masonry scoop / Mörtelöffel / Штукатурный ковш / Черпак мулярський / Κάτίνες σερπηλό / Canciocr / Zednická naberačka / Murárska naberačka / Zidarska zajemalka / Mürininko kaušas / Mürnieka kauss / Müürsepalup / Зидарско канче / Zidarska fangla / Zidarsko vedro / Δοχείο κοιμάματος με χειρολαβή / Recogedor para mortero / Vaschetta per muratore / Concha de pedreiro / Louche de maçon / Metselschep

**NEO**  
TOOLS



Ref.	ø [mm]	☒	EAN
50-252	170	0/50	5907558438642

**T TOPEX**



Ref.	ø [mm]	☒	EAN
13A890	160	0/50	5902062092502

## Ostrze wymienne do szpachli

Replaceable blade for scraper extreme / Сменный нож для скребка / Змінне лезо для скребка екстремального / Cserélhető penge az kaparóhoz / Spatulă înlocuibilă pentru racla extreme / Vyměnitelné ostří / Ostrie výmenné lichobežníkové / Nadomestno rezilo / Keičiamos geležtės / Naža asmeņi / Noaterad / Nozici za skalpel / Ανταλλακτικές λεπίδες / Hojas de repuesto para cúter / Lame di ricambio / Lâminas substituíveis / Lames de remplacement / Vervangmesbladen

**NEO**  
TOOLS

**EXTREME**



Ref.	for	W [mm]	☒	EAN
50-550	50-500	250	0/5	5907558453461
50-551	50-501	400	0/5	5907558453478
50-552	50-502	600	0/5	5907558453485
50-553	50-503	800	0/5	5907558453492
50-554	50-504	1000	0/5	5907558453508

## Szpachla

Scraper / Spachtel / Шпатель / Шерхебель / Festékkaparó / Ráztaore / Špachtle / Špachtla univerzálna / Strgalo / Glaistyklé / Špaktelis / Kaabits / Шпакля / Višenamjenska lopatica za kit / Spahtla / Σπάτουλα οδοντωτή / Espátula universal / Spatola / Betumadeira / Spatule / Plamuurmes

**NEO**  
TOOLS

**EXTREME**

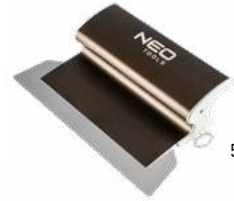

50-500



50-501



50-502

Ref.	W [mm]	☒	EAN
50-500	250	0/4	5907558453416
50-501	400	0/4	5907558453423
50-502	600	0/4	5907558453430
50-503	800	0/2	5907558453447
50-504	1000	0/2	5907558453454

## Uchwyt do szpachli EXTREME

Holder scraper EXTREME / Держатель скребка EXTREME / Τριμαχ σκρεβκα EXTREME / Tartó kaparó EXTREME / Rázvitor de suport EXTREME / Držák / Držiak / Zanka / Kijpa plaktukui / Josta ämuram / Ηααμριαας / Χαηφ / Držáč / Torbica za alat / Θήκη σφουριού / Portamartillo / Manico / Suporte / Manche / Houder

**NEO**  
TOOLS

**EXTREME**

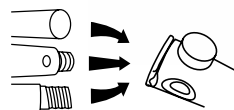

Ref.	for	☒	EAN
50-531	50-500	0/4	5907558484540



## Szpachla do sztablatury

Scraper / Gipsedelputzspachtel / Шпатель для венецианской штукатурки / Шерхебель / Felületsimító / Ráztaoare / Špachtle na benátskou omítku / Špachtla štúkatérska nerez / Strgalo / Glaistyklé / Špaktelis apmetumam / Kaabits / Шпакля / Fasadna Lopatica za kit / Strugac / Ξύστρα / Espátula para acabado de yeso / Spatola per finiture in gesso / Betumadeira / Spatule pour enduit de qualité / Plamuurmes voor pleisterwerk

**NEO**  
TOOLS



STAINLESS  
steel

Ref.	W [mm]	☒	EAN
50-304	350	0/25	5907558438727
50-305	450	0/25	5907558438680
50-306	600	0/20	5907558438758

**TOPEX**



STAINLESS  
STEEL

Ref.	W [mm]	☒	EAN
13A520	200	0/10	5902062091772
13A525	250	0/10	5902062091789
13A530	350	10/10	5902062091314
13A545	450	10/30	5902062091321
13A560	600	0/10	5902062091574

## Szpachla malarska

Scraper / Malerspachtel / Шпатель малярный / Шерхебель / Festékkaparó / Ráztaoare / Malířská špachtle / Špachtla maliarska / Strgalo / Glaistyklé / Špaktelis / Kaabits / Шпакля / Lopatica za kit / Spahtla / Σπάτουλα οδοντωτή / Espátula de pintor / Spatola da muro / Betumadeira p. Pintura / Spatule de peinture / Plamuurmes voor verfwerk

**NEO**  
TOOLS



STAINLESS  
steel

Ref.	W [mm]	☒	EAN
50-351	20	12/120	5902062062642
50-352	40	12/120	5902062062659
50-353	50	12/120	5902062062666
50-354	63	12/120	5902062062673
50-355	75	12/120	5902062062680
50-356	100	12/120	5902062062697
50-357	125	12/120	5902062062703
50-358	150	12/120	5902062062710
50-359	200	12/120	5902062062727
50-360	250	12/120	5902062062734

**TOPEX**



STAINLESS  
STEEL

Ref.	W [mm]	☒	EAN
18B604	40	12/120	5902062186041
18B605	50	12/120	5902062186058
18B606	63	12/120	5902062186065
18B607	75	12/120	5902062186072
18B610	100	12/120	5902062186102
18B612	125	12/120	5902062186126

**TOPEX**



Ref.	W [mm]	☒	EAN
18B218	61	12/240	5902062120885

**TOPEX**



Ref.	W [mm]	☒	EAN
18B204	40	12/240	5902062120731
18B206	60	12/240	5902062120748
18B208	80	12/240	5902062120687
18B210	100	12/144	5902062120694
18B212	125	12/144	5902062120984
18B215	150	12/144	5902062120717

**TOP TOOLS**



Ref.	W [mm]	☒	EAN
18B120	100	0/100	5902062181206

**TOP TOOLS**



Ref.	W [mm]	☒	EAN
18B303	30	12/240	5902062120014
18B304	40	12/240	5902062120021
18B305	50	12/240	5902062120038
18B306	60	12/240	5902062120045
18B308	80	12/240	5902062120052
18B310	100	12/240	5902062120069
18B312	125	12/144	5902062120403

**TOP TOOLS**



Ref.	W [mm]	N	☒	EAN
18B330	30 - 80	×3	12/72	5902062090669

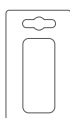

## Szpachle malarskie

Scraper set / Malerspachteln / Шпатели малярные / Шерхебели, набір / Gletteló készlet / Rázítóare set / Malířské špachtle / Špachtle maliarske set / Garnitura strgal / Glaistyklys / Špakteļu komplekts / Kaabitsakomplekt / Шпакли / Špachtle / Spachtla set / Συλλογή από σπάτουλες οδοντωτές / Espátula de pintor / Spatole giarponesi / Betumadeiras p. Pintura / Spatules de peinture / Verf-plamuurmessen

**TOPEX**

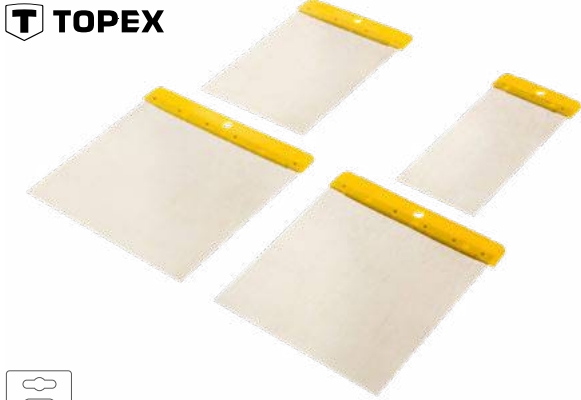

**x4**

**STAINLESS STEEL**

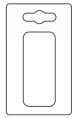

Ref.	W [mm]	⊠	EAN
18B436	50, 80, 100, 120	10/100	5902062121790

## Szpachelki do silikonu

Silicone spatula / Silikonspachtel / Шпатели для силикона / Шпадли по силикону / Szilikon glettvás / Spatule pentru silicon / Špachtle na silikon / Silikónové špachtle / Lopatica za silikon / Mentelės silikonui / Silikona špachtele / Silikonispaattid / Шпакли за силикон / Špachtle za silikon / Lopatice za silikon / Σπάτουλες για σιλίκονη / Espátulas para silicona / Spatole per silicone / Espátulas para silicone / Spatules en silicone / Spatel voor silicoon

**TOPEX**



**x4**

**TPR**

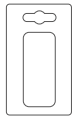

Ref.	⊠	EAN
16B472	0/100	5902062057334

## Zdzierak

Scraper / Vorfeile / Рубанок / Шерхебель / Ráspoly / Čužit de razuit / Rašpljovj hoblík / Rašpļa / Strgalo / Dildé / Évele / Raspel / Нож за груба обработка / Odbojnik / Rende / Πλάνη / Escofina / Spatola / Lima grossa / Råpe / Krabber

**NEO TOOLS**



**SK2 STEEL**

**HARDENED**

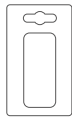

Ref.	W [mm]	⊠	EAN
50-257	140	10/60	5907558465167
50-258	250	10/40	5907558465174

## Ostrze do zdzieraka

Scraper blade / Schrupphobelklinge / Лезвие для рубанка-рашпиля / Лезо до шерхебеля / Ráspolybetét / Lamã racletã / Ostří do uběráku / Plátok náhradný / Rezilo za strgalo / Grandklio geležě / Asmenis skrãpim / Kaabitsa leht / Ρενδε / Ulošci za strugač / Ulošci za stugač / Λενίδα για ζίστρα / Hoja para escofina / Lama per pialla / Lámina p. lima grossa / Tranchant de råpe / Krabberblad

**NEO TOOLS**



**SK2 STEEL**

**HARDENED**

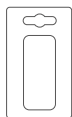

Ref.	W [mm]	⊠	EAN
50-267	140	40/200	5907558465181
50-268	250	40/200	5907558465198

**TOP TOOLS**



**x4**

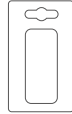

Ref.	W [mm]	N	⊠	EAN
18B437	50, 80, 100, 120	x4	0/240	5902062121806

## Zdzierak do styropianu

Scraper for polypropylene board / Vorfeile für geschäumtes Polystyrol / Рубанок / Тертка до пінопласту / Polisztírol csiszoló / Gletiera pentru razuit / Hoblík na polystyrén / Rašpļa na polystyrén / Strgalo za stiropor / Trintivé puty polistírolui / Évele / Vahtpalüsterooliraspel / Нож за груба обработка на стиреопор / Odbojnik za stiropor / Rende za stiropor / Πλάνη / Escofina para poliestireno / spatola per tavola in polipropilene / Lima grossa para poliestireno extruido / Råpe pour polystyrène / Krabber voor polystyreen

**NEO TOOLS**



**Ergonomic beechen handle**

Ref.	L [mm]	W [mm]	⊠	EAN
50-251	270	130	0/20	5907558438604

**TOPEX**



Ref.	L [mm]	W [mm]	⊠	EAN
13A360	270	130	0/15	5902062091710

## Tarnik aluminiowy do płyt G/K

Aluminium rasp file for plaster-cardboard panels / Aluminium-Raspel für G/K-Platten. / Алюминиевий рашпиль для гипсокартона / Алюминиевий рашпиль для гипсокартонных плит / Aluminium tömbreszelő GK lapokhoz / Rindea din aluminiu pentru plăci gips carton / Rašpļa na sadrokartonové desky / Hliníková rašpļa na sadrokartonové dosky. / Aluminijeva strgalo za mavčno-kartonske plošče / Alumininis gipso kartono plokščiu oblius-dildė / Aluminija vile gipskartona plākšņēm. / Alumiiniumist raspel kipsplaatidele. / Αλουμινεα ρασιπλια за гипсокартонени плоскости. / Aluminijska rašpica za OSB ploče / Renda od aluminija za OSB ploče / Pána alumiiniu για γυψοσανίδες / Raspador de aluminio para placas cartón yeso / Raspa in alluminio per pannelli in cartongesso / Raspador de aluminio para placas de gesso cartonado / Lime en aluminium pour plaques de plâtre G/K / Aluminium rasp voor G/K-platen

**NEO TOOLS**



**ALUMINIUM**

**140 mm**

50-421

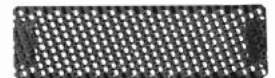

Ref.	⊠	EAN
50-420	10/60	5907558471571
50-421	20/200	5907558471588



## Blok ścierny

Sanding block / Schleifblock / Блок шлифовальный / Блок шліфувальний / Csiszolótuskó / şlefuitoare de obezi / Brusný blok / Držák brúsneho papiera / Brusni papir / Šlifavimo skremulys / Smilšpapira turētājs / Lihvimisklots / Шлаїер / Držač brusnog papira / Brusni papir u rolni / Τάκος λείανσης / Bloque abrasivo / Tampono per levigare / Redes abrasivas / Grilles abrasives / Schuurblok

NEO  
TOOLS



for  
135x  
115mm  
sanding sheets

114x  
55x  
38mm

Ref.	L [mm]	W [mm]	☒	EAN
50-260	114	55	12/96	5907558483345

## TOPEX



Ref.	L [mm]	W [mm]	☒	EAN
08A108	165	85	1/100	5902062206923
08A110	210	100	30/60	5902062206930

## Plótna ścierna

Abrasive cloths / Schleifleinen / Шлифовальные полотна / Полотна наждакові / Csiszolóvászon / Pânze abrazive / Brusná plátna / Brúsne plátna / Brusna platna / Šlifavimo popieriai / Šlipėšanas audekls / Lihvriie / Абразивни платна / Brusna platna / Abrazivna platna / Χαρτιά λείανσης / Lijas de tela / Tela abrasiva / Tecidos abrasivos / Toiles abrasives / Schuurtextielen

## TOPEX



x10

Ref.	L x W [mm]	K	☒	EAN
08A422	230 x 280	40	0/34	5902062211019
08A424	230 x 280	60	1/34	5902062211026
08A426	230 x 280	80	0/45	5902062211033
08A428	230 x 280	100	0/45	5902062211040
08A430	230 x 280	120	15/45	5902062211057
08A434	230 x 280	220	1/68	5902062211071

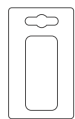

## Siatki ścierne

Abrasive grids / Schleifgitter / Шлифовальная сетка / Сітки наждакові / Csiszolórács / Plase abrazive / Brusne sítky / Brusna mrežka / Brusne mreže / Šlifavimo tinklėliai / Šlipėšanas tīkli / Lihvvörk / Абразивни мрежи / Brusne mreže / Abrazivne mreže / Πλέγμα λείανσης / Mallas de lijado / Carta abrasiva / Redes abrasivas / Grilles abrasives / Schuurmetten

## TOPEX

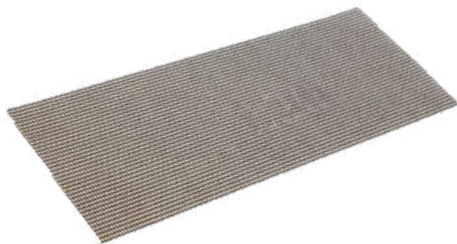

Ref.	L x W [mm]	K	N	☒	EAN
08A606	280 x 110	60	x5	0/420	5902062211491
08A608	280 x 110	80	x5	0/200	5902062211507
08A610	280 x 110	100	x5	0/500	5902062211514
08A612	280 x 110	120	x5	0/520	5902062211521
08A615	280 x 110	150	x5	0/560	5902062211538

## Uchwyt do prznoszenia płyt G/K

Carrying handle for plaster-cardboard / Tragegriff für die Handhabung von G/K / Держатель для переноски гипскартона / Тримач для перенесення гипскартонних плит / Tartó GK, lapok mozgatásához / Dispozitiv pentru transportat plăci gips carton / Držák pro přenášení sádrokartonových desek / Držák na prenášanie sadrokartónových dosiek / Držalo za prenašanje mavčno-kartonskih plošč / Gipso kartono plokščiu transportavimo laikiklis / Ğipşkartona plākšņu pārmēšāšanas rokturis / Käepide kipsplaatide kandmiseks / Дръжка за пренасяне на гипскартон / Drška za prenošenje OSB ploča / Drška za prenošenje ploča OSB / Λαβή μεταφοράς γυψοσανίδων / Porta placa yeso cartón / Maniglia per il trasporto di pannelli in cartongesso / Suporte de placa de gesso cartonado / Poignée de transport pour plaques de plâtre G/K / Handgreep voor het dragen van G/K-en

NEO  
TOOLS



up to  
80kg

MATERIAL  
ABS

Ref.	☒	EAN
50-400	6/24	5907558471557

## Dźwignia do podnoszenia płyt G/K

Lever for lifting plaster-cardboard panels / Hebel zum Anheben von G/K-Platten / Рычаг для подъема гипскартона / Ручна для піднімання гипскартонних плит / Emelőkar GK / Dispozitiv de ridicat plăci gips-carton / Páka na zvedání sádrokartonových desek / Páka na prenášanie sadrokartónových dosiek / Vzdov za dvigovanie mavčno-kartonskih plošč / Gipso kartono plokščiu keltuvas / Svira Ğipşkartona plākšņu / Kang kipsplaatide kandmiseks / Лост за повдигане на гипскартонени плоскости / Dizalo za podizanje OSB ploča / Dizalica za prenošenje ploča OSB / Μοχλός ανύψωσης γυψοσανίδας / Palanca para levantar placas cartón yeso / Leva per alzare pannelli in cartongesso / Alavanca para levantar placas de gesso cartonado / Levier pour soulever les plaques de plâtre G/K / Hendel voor het optillen van G/K-platen

NEO  
TOOLS



max lift  
38mm

up to  
100kg

Ref.	☒	EAN
50-410	12/24	5907558471564

## Wiadro

Bucket / Eimer / Ведро / Бідро / Festövödör / Čáldare / Kbelík / Vedro stavbárske / Vedro / Kibiras / Spainis / Ámber / Κοφα / Kanta / Kofa za malter / Κάδος / Cubo de obra / Mastello / Balde / Seau / Emmer

## TOPEX



Ref.	V max [l]	☒	EAN
13A700	10	0/1	5902062091550



## Wiadro budowlane

Bucket / Eimer für Bauzwecke / Ведро растворное / Відро будівельне / Habarcsvödör / Galeata pentru mortar/construcții / Stavební kbelík / Stavební vedierko / Zidarsko vedro / Kibiras / Būvniecības spainis / Ehitusämber / Кофа за приготвяне на разтвор / Zidarsko vjedro / Građevinska kofo / Κουβάς κονιάματος / Cubo de obra / Secchio / Balde industrial / Seau de chantier / Bouwemmer

**TOPEX**



Ref.	V max [l]	☒	EAN
13A703	12	0/1	5902062091567

## Kastra budowlana

Mortar container / Mörtelkasten / Емкость растворная / Корито будівельне / Habarcsláda / Contaner p/u seatur de construcție / Korba na maltu / Nádoba na maltu / Zidarska kanta / Statybinių karučiai / Celtniecības toveris / Мördinõu / Леген строителен / Mortaljka / Gipsarski kontejner / Σκάφη οικοδομής / Cubo para mortero / Contenitore per malta / Tanque para construção / Auge de construction / Mortelbak

**TOPEX**



Ref.	V max [l]	☒	EAN
13A760	65	0/1	5902062091185
13A780	90	0/1	5902062091192

**TOPEX**



Ref.	V max [l]	☒	EAN
13A712	12	0/1	5902062091161
13A720	20	0/1	5902062091178

**TOPEX**



Ref.	V max [l]	☒	EAN
13A716	16	0/1	5902062092427

## Sznurek murarski

Masonry line / Maurerschnur / Шнур разметочный каменщика / Шнур мулярський / Kőműveszsinór / Linie zidire / Zednický provázek / Šnúrka murárska / Zidarska vrv / Virvelé mūrīninkui / Mūrnieka aukla / Mūrīnõör / Канан зидарски / Zidarski konac / Zidarski kanap / Σκοινί οικοδόμου / Cuerda de albañil / Filo per muratore / Corda p. Alvenaria / Fil de maçons / Metselsnoer

**NEO TOOLS**



ø1.5 mm

Ref.	L [m]	☒	EAN
49-905	50	32/128	5907558440072
49-910	100	16/64	5907558440058

**NEO TOOLS**

ø0.9 mm



Ref.	L [m]	☒	EAN
49-920	100	25/100	5907558440065

## Sznurek

Rope / Schnur / Шнурок / Шнур / Spárga / Snur / Provázek / Šnúrka / Vrv / Raištelis / Auklija / Nõör / Въжел / Копорас / Копорас, uzica / Корбон / Cuerda / Spago / Corda / Fil

**NEO TOOLS**



1000 mb  
PP  
40 daN  
15cm  
1000 TEX  
+/- 3%

Ref.	L [m]	☒	EAN
49-931	1000	0/6	5907558465402

## Žytká murarska

Masonry line / Maurerleine / Лесна разметочная каменщика / Жылтка мулярський / Kőműveszsinór / Linie zidire / Zednická šnůra / Lanko murárske / Zidarska vrv / Valas mūrīninkui / Mūrnieka stieple / Mūrīnõör / Зидарско въже / Zidarski konac / Zidarski kanap / Λαστικέλιο λουράκι οικοδόμου / Hilo de nilón / Filo per muratore / Linha para construção / Fil de maçon / Metselknijlijn

**NEO TOOLS**

100 m ø1.0 mm



Ref.	L [m]	Ø [mm]	☒	EAN
49-915	100	1	20/240	5907558440089





## Kreda techniczna

Marking chalk / Kreide für technische Zwecke / Мел технический / Крѐйда технична / Jelölökrtá fehér / Credă tehnică / Technická křída / Technická krieda / Industrijska kreda / Pramoninė kreida / Tehniskais krīts / Tehniline kriit / Τεχνικη μέβευση / Tehnička kreda / Tehnička kreda / Κυμάλια τεχνική / Tiza técnica / Gesso da imbianchino / Giz técnica / Craie industrielle / Markeerkrijt

**NEO**  
TOOLS

x3

13x85  
mm

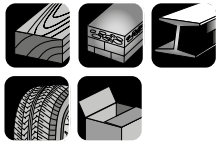
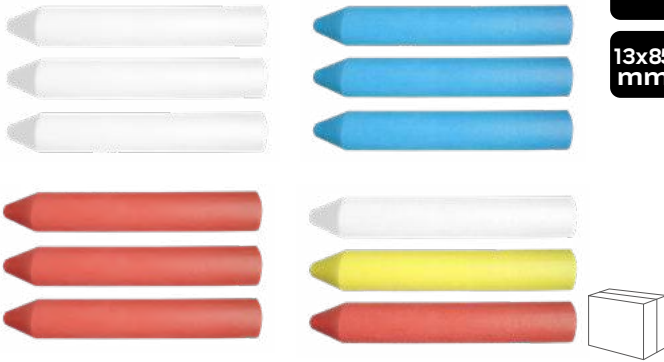

Ref.	color	⊠	EAN
13-950		12/240	5907558443936
13-954		0/240	5907558443943
13-956		0/240	5907558443950
13-968		0/240	5907558443967

**NEO**  
TOOLS

x12

120x12  
mm

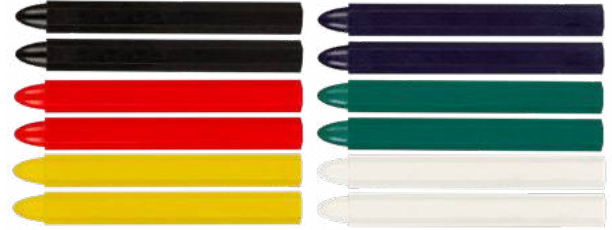

Ref.	color	⊠	EAN
13-961	color	0/50	5907558440072
13-962		0/50	5907558440058
13-963		0/50	59020622063526

## Kreda do trasowania

Chalk / Trassierkreide / Мел трассировочный / Крѐйда трасувальна / Porfesték / Creță / Křída / Farba / Kreda / Kreida žymėjimai / Krīts krīta līnijas / Kriit / Крѐда за чертулка / Prah za crtanje / Prah za obeležavanje / Κυμάλια για χάραξη / Polvo de trazado / Polvere tracciante / Giz p. traçar / Craie à tracer / Krijt

**T TOPEX**



Ref.	m [g]	color	⊠	EAN
30C616	115		10/100	5902062111869
30C617	115		10/100	5902062111876

## Ołówek murarski

Masonry pencil / Maurerstift / Карандаш каменщика / Олівець мулярський / Ácsceruza / Creion piatră / Zednická tužka / Ceruzka murárska / Zidarski svinčnik / Mürininko pieštukas / Zimulis galdnieka / Mürseapliats / Μονυε / Olovka za majstore / Olovka za majstore / Μολύβι λιθοδόμου / Lápiz de albañil / Matita da carpentiere / Lápiz p. Alvenaria / Crayon de maçons / Metselaarspotlood

**NEO**  
TOOLS

4H



Ref.	L [m]	⊠	EAN
13-801	240	72/1440	5907558443981

## Ołówek do szkła

Pencil for glass / Glasstift / Карандаш по стеклу / Олівець по склу / Ácsceruza / Creion sticlă / Tužka na sklo / Ceruzka sklenárska / Svinčnik za steklo / Pieštukas stiklui / Zimulis stiklam / Klaaspliats / Μονυε za steklo / Olovka za staklo / Olovka za staklo / Μολύβι ξυλοφυγού / Lápiz para vidrio / Matita per vetro / Lápiz para vidro / Crayon à verre / Glaspotlood

**NEO**  
TOOLS

R



Ref.	L [m]	⊠	EAN
13-802	240	72/1440	5907558443998

## Ołówek stolarski

Carpenter's pencil / Tischlerstift / Карандаш столярный / Олівець столярний / Ácsceruza / Creion lăcătuș montor / Tesařská tužka / Ceruzka stolárska / Tesarski svinčnik / Stalius pieštukas / Zimulis galdnieka / Puuseapliats / Μονυε / Olovka za majstore / Olovka za majstore / Μολύβι ξυλοφυγού / Lápiz de carpintero / Matita da carpentiere / Lápiz p. Madeira / Crayon de menuisier / Timmermanspotlood

**NEO**  
TOOLS

HB



Ref.	L [m]	⊠	EAN
13-800	240	72/1440	5907558443974

**TOP TOOLS**



Ref.	N	⊠	EAN
14A810	×1	144/1440	5902062104649
14A803	×3	100/300	5902062120861
14A812	×12	24/240	5902062121127
14A872	×72	5/40	5902062203014

## Ołówek techniczny czerwono-niebieski

Carpenter's pencil red and blue / Technischer Bleistift / Технический карандаш красно синий / Технічний олівець червоно-синій / Műszaki ceruza piros és kék / Set 12 creioane cu cap dublu, 2 culori / Tužka / Ceruzka / Svinčnik / Pieštukas / Pliats / Μονυε / Olovka / Olovka / Μολύβι / Lápiz / Matita / Lápiz / Crayon / Potlood

**NEO**  
TOOLS

x12

175  
mm



Ref.	L [m]	⊠	EAN
13-805	240	0/120	5907558443998

**TOP TOOLS**



Ref.	⊠	EAN
14A892	144/1440	5902062121035



## Ółówek stolarski / murarski automatyczny

Masonry Carpenters Automatic Pencil / Masonry Carpenters Automatic Pencil / Автоматический карандаш каменщика / Автоматический олоець муляра / Automatikus ácsceruza / Creion mecanic de timplarie / Tužka / Ceruzka / Svinčnici / Pieštukas / Žimulis / Pliats / Молюс / Olovka / Olovka / Μολύβι / Lápiz / Matita / Lápiz / Crayon / Potlood

NEO TOOLS

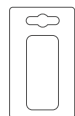

Ref.	⊠	EAN
13-810	25/250	5902062063441

NEO TOOLS

x6  
graphites

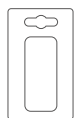

Ref.	⊠	EAN
13-815	20/100	5902062063458

NEO TOOLS



Ref.	⊠	EAN
13-816	0/100	5907558483352

## Grafit

Graphite / Графитум / Grafit / Grafit / Tuha / Grafit / Grafitas / Grafits / Grafiit / Графитум / Grafit / Grafit / Γραφίτης / Engrase / Grafite / Grafite / Graphite / Grafiet

NEO TOOLS



x5

Ref.	⊠	HB	⊠	EAN
13-820	□	HB	100/1000	5902062063465
13-821	■	HB	100/1000	5902062063472
13-822	■	2H	100/1000	5902062063489

## Temperówka do ołówek technicznych

Carpenters pencil sharpener / Точилка для технических карандашей / Точилка для технічних олівців / Ácsironhegyező / Ascuțitor pentru creioane de tâmplărie

NEO TOOLS



Ref.	⊠	EAN
13-830	40/400	5902062063496

## Marker permanentny

Permanent marker / Permanentmarker / Перманентный маркер / Перманентний маркер / Jelölőfilc mini / Marker permanent / Permanentní popisovač / Permanentní popisovač / Permanentni marker / Permanentinis markeris / Permanents markieris / Permanentmarker / Постоянен маркер / Permanentni marker / Trajnji marker / Ανεξίτηλος μαρκαδόρος / Marcador permanente / Marker permanente mini

TOPEX

x80



Ref.	⊠	EAN
14A895	80/1280	5902062008718

## Szczotka druciana

Wire brush / Drahtbürste / Щетка проволочная / Щітка по металу / Spidkefe / Perie metal / Drátěný kartáč / Keľa drôtená univerzálna / Žična krtčača / Vielinis šepetyš / Dräsu birste / Traathari / Четка мелена / Četka sa PVC drškou / Cetka / Συρμάτινη βούρσα / Cepillo de alambre / Spazzola metallica / Escova de arame / Brosse métallique / Draadborstel

NEO TOOLS

STEEL



Ref.	rows	⊠	EAN
39-010	4x16	10/100	5907558452624
39-012	3x19	12/36	5907558452693

NEO TOOLS

BRASS



Ref.	rows	⊠	EAN
39-030	4x16	10/100	5907558452631
39-032	3x19	12/36	5907558452709
39-031	5x11	12/72	5907558452662

NEO TOOLS

NYLON



Ref.	rows	⊠	EAN
39-011	5x11	12/72	5907558452655

NEO TOOLS

STAINLESS STEEL



Ref.	rows	⊠	EAN
39-050	4x16	10/100	5907558452648
39-052	3x19	12/36	5907558452716
39-051	5x11	12/72	5907558452679

NEO TOOLS

x3



STEEL

NYLON

BRASS

Ref.	rows	⊠	EAN
39-100	3x7	12/120	5907558452686



## Szczotka druciana

Wire brush / Drahtbürste / Щетка проволочная / Щетка по металлу / Spidkefe / Perie metal / Drátěný kartáč / Keľa drôtená univerzálna / Žična krtača / Vielinis šepetyš / Drāšu birste / Traathari / Четка телена / Četka sa PVC drškom / Četka / Συρμάτινη βούρτσα / Cepillo de alambre / Spazzola metallica / Escova de arame / Brosse métallique / Draadborstel

**TOPEX**



Ref.	L [mm]	☒	EAN
14A523	240	12/120	5902062120960

**TOPEX**



Ref.	rows	☒	EAN
14A614	4	12/120	5902062121677
14A615	5	12/120	5902062121684
14A616	6	12/120	5902062121691

**TOP TOOLS**



Ref.	rows	☒	EAN
14A604	4	12/72	5902062120083
14A605	5	12/72	5902062120090
14A606	6	12/72	5902062120106

**TOP TOOLS**



**x3**

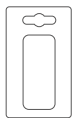

Ref.	L [mm]	☒	EAN
14A618	180	12/144	5902062202482
14A623	230	12/72	5902062202819

## Wycinaki do otworów

Hole punch set / Lochausschneidemaschine / Пробойники круглых отверстий / Кернер, набір / Börtvukasztó készlet / Set perforare găuri / Vykrajovačka do otvorů / Súprava vysekávačov / Gamitura prebijáčev / Pjovikljai ertméms / Caurumsitēju komplekts / Augustaja komplekt / Замби компл. / Probijači set / Zumbeset / Συρμίγιες / Sacabocados / Pinzoni per forare / Matriz de recortar / Bédanes à ouvertures / Gatenknippers

**TOPEX**



**x9**

Ref.	Ø [mm]	☒	EAN
03A490	3 - 12	0/20	5902062031761



## Szczotka ulicowa u uchwytem metalowym

Street broom with metal handle / Straßenbürste mit Metallgriff / Щетка уличная с металлической ручкой / Щетка вулична із металевею ручкою / Úttest seprű fém nyélrel / Perie de stradă cu mâner metalic / Poulčni kartáč s kovovou rukojetí / Metla na zametanie ulice s kovovou rukoväťou / Cestna krtača s kovinskim ročajem / Gatvės šepetyš su metaline rankena / Ielas birste ar metāla rokturi / Metallist käepidemega tänavahari / Улична метла с металната дръжка / Ulična četka s metalnom drškom / Ulična metla sa metalnom drškom / Βούρτσα δρόμου με μεταλλική λαβή / Escoba de carretera con soporte metálica / Spazzola da strada con manico in metallo / Vassoura de rua com cabo de metal / Brosse de rue avec manche métallique / Straatborstel met metalen handvat /

**NEO TOOLS**



**HEAVY DUTY**  
**METAL SOCKET**  
ø22mm

Ref.	L [cm]	☒	EAN
39-200	30	0/10	5907558468212
39-201	40	0/10	5907558468229
39-202	50	0/10	5907558468236
39-203	60	0/10	5907558468243
39-204	80	0/10	5907558468250

## Styl do szczotek

Broom handle / Bürstenhalter / Рукотка для щеток / Рукотка для щіток / Seprűnyél / Suport pentru perii / Držák štětky / Vlastnosti štetin / Ročaj za krtače / Šepećio kotas / Kāts birstēm / Harjajars / Държач за четки / Drška za četke / Drška za četke / Λαβή βούρτσας / Mango para escoba / Gamba per spazzoli / Cabo de vassoura / Manche pour brosse / Borstelstijl

**NEO TOOLS**

**ø22 mm**



Ref.	L [cm]	☒	EAN
39-250	120	0/25	5907558468267
39-251	150	0/25	5907558468274

## Ostrzałka do noży i nożyczek

Knife and scissor sharpener / Rasenmäher-Messerschärfer / Точилка для ножей и ножниц / Точилка для ножієв i ножиць / Élező késekhez és ollókhöz / Dispozitiv de ascuțit cuțite și foarfeci / Ostrič noži a nůžek / Brúsič na nože a nožnice / Brusilec nožev in škarij / Peilių ir žirklių galastuvas / Asināmais nažiem un šķērēm / Nugade ja kāiāride teritaja / Точило за ножове и ножници / Ostričica za noževe i škare / Ostričica za noževe i makaze / Ακονιστήρι μαχαιριών και ψαλιδιών / Afilador de cuchillos y tijeras / Affilatrice per coltelli e forbici / Afjador de faca e tesoura / Aiguiseur pour couteaux et ciseaux / Messenslijper

**NEO TOOLS**



**3 STEP SHARPENING**  
**REGULATED ANGLE**  
**ANTI-SLIP BOTTOM SURFACE**  
**SCISSOR SHARPENING**

Ref.	☒	EAN
56-050	6/48	5907558482638

**NEO TOOLS**



**2 STEP SHARPENING**  
**SCISSORS**  
**ANTI-SLIP BOTTOM SURFACE**  
**ANTI-SLIP GRIP**

Ref.	☒	EAN
56-053	6/48	5907558482645



## Ostrzałka do noży

Knife sharpener / Messerschärfer / Точилка для ножей / Точилка для ножиц / Élező késekhez / Dispositif de ascuțit cuțite / Ostržič noží / Brúsič na nože / Brusilec nožev / Peilių galštuvus / Asināmais nažiem / Nugade teritaja / Точило за ножове / Oštrilica za noževe / Oštrilica za noževe / Ακονιστήρι μαχαιριών / Afilador de cuchillos / Affilatrice per coltelli / Afjador de faca / Aiguiseur pour couteaux / Messenslijper

**NEO**  
TOOLS



Ref.	📦	EAN
56-054	12/96	5907558482652

## Strug

Plane / Hobel / Рубанок / Рубанок / Gyalu / Rindea / Hoblík / Hoblík / Oblič / Oblus / Èvele / Høövel / Ρειδε / Blanja / Strug / Πλάνι / Cepillo / Piiala / Garlopa / Rabot / Schaafmachine

**T TOPEX**



Ref.	L [mm]	W [mm]	W noża [mm]	📦	EAN
11A230	240	30	30	0/20	5902062100115

**T TOPEX**



Ref.	L [mm]	W [mm]	W noża [mm]	📦	EAN
11A314	200	55	40	0/25	5902062030894

**TOP TOOLS**



Ref.	L [mm]	W [mm]	📦	EAN
11A145	235	45	0/24	5902062100764

## Nóż do szkła

Glass cutter / Glasmesser / Στεκτοpez / Στεκτοpez / Üvegvágó / Cuțit sticlă / Nůž na sklo / Rezač na sklo / Nož za steklo / Peilis stiklui / Stiklgriezis / Klaasiõikur / Επμαз Topex / Nožič za staklo / Nozic za staklo / Κοπικό εργαλείο γυαλιού / Cuchillo cortador de vidrio / Coltello per vetro / Faca para vidro / Couteau à verre / Glasmes

**NEO**  
TOOLS

LIFETIME  
5000m

WOODEN  
HANDLE



Ref.	📦	EAN
56-820	0/240	5907558461688

**NEO**  
TOOLS

LIFETIME  
15000m

TUNGSTEN  
CARBIDE  
CUTTING  
WHEEL



Ref.	📦	EAN
56-821	0/240	5907558461671

**T TOPEX**



Ref.	📦	EAN
14A710	12/48	5902062501004

**Bohle**



Ref.	model	📦	EAN
320.0	Jobo	12/1200	5902062200037
100.0	Silberschnitt	12/600	4010122100003



## Przyssawka

Vacuum cup / Saugnäpfchen / Присоска / Присоска / Tapadókorong / Dispozitiv de aspiratie / Přisavka / Přisavka / Prisesek / Siurbtukas / Piesūceknis / Iminapp / Βεντούζα / Vakuum kapa / Sisaljka / Βεντούζα / Ventosa / Ventosa / Copo de sucção / Ventouse / Zuighouder

**NEO**  
TOOLS



Ref.	Fmax [kg]	☒	EAN
56-805	40	6/48	5907558465211

**NEO**  
TOOLS



Ref.	Fmax [kg]	☒	EAN
56-806	80	6/24	5907558465228

**NEO**  
TOOLS



Ref.	Fmax [kg]	☒	EAN
56-800	160	0/10	5907558454246

**NEO**  
TOOLS



Ref.	Fmax [kg]	☒	EAN
56-801	50	0/48	5907558461640

**NEO**  
TOOLS



Ref.	Fmax [kg]	☒	EAN
56-802	100	0/24	5907558461657

**NEO**  
TOOLS



Ref.	Fmax [kg]	☒	EAN
56-803	150	0/12	5907558461664

## Kobyłka warsztatowa

Axle stand / Werkbock / Стойка-козел / стелаж для майстерні / Mühely bak / Stand tip stativ de atelier / Dílenská koza / Dílenská koza / Štirinožno stojalo / Dirbtuvės stovas / Darbnīcas statnis / Töölus / Работно мазапе / Radni stalak za radionicu / Stalak za radionicu / Πάγκος εργασίας συνεργείου / Caballete de / Cavalletto da lavoro / Atelier Kobyłka / Bok

**NEO**  
TOOLS



Ref.	☒	EAN
84-145	0/1	5907558482621

**TOPEX**



Ref.	☒	EAN
79R187	0/4	5902062791870



## Stół warsztatowy

Work bench / Werkstattbank / Стол-верстак / Вертмак / Munkapad / Teigheia tímpláirie / Dilenský stůl / Stólik pracovný / Delavniška miza / Darbastalis / Darba galds / Tööpink / Работна маса / Stol radionički / Radni sto / Πάγκος εργαίας / Banco de trabajo / Tavolo da lavoro / Mesa de oficina / Etabli d'atelier / Werkplaatstafel

**TOPEX**



Ref.	W [mm]	L [mm]	H [mm]	☒	EAN
07A420	600	240	800	0/1	5902062160829

**TOP TOOLS**



Ref.	W [mm]	L [mm]	H [mm]	☒	EAN
07A415	640	560	780	0/1	5902062169471

## Podpora teleskopowa

Quick support / Teleskopstütze / Опора телескопическая / Опора телескопична / Támasztó / Suport telescopic / Teleskopová podpora / Podpera teleskopická "třetí ruka" / Stega / Teleskopinė atrama / Stute teleskopiska / Teleskoop-tugi / Подпора телескоп. / Teleskopski nastavak / Teleskopski nastavak / Βάση / Soporte telescópico / Supporto telescopico / Suporte telescópico / Support télescopique / Telescopische steun



Ref.	L [cm]	☒	EAN
35-430	100-290	4/8	5907558465310
35-431	75-125	4/8	5907558465327



Ref.	L [cm]	☒	EAN
35-432	115-290	0/4	5907558465334
35-433	50-115	0/4	5907558465341

## Pędzel płaski uniwersalny

Universal paintbrush / Allzweckpinsel / Кисть универсальная / Пензель универсальной / Ecset / Pensula universal / Univerzální štětec / Štetec univerzálny / Čopič univerzalni / Universalus šepetys / Universāla ota / Universaalpintsel / Универсална четка / Univerzalni kist / Univerzalna četkica / Πινέλο πολυπλών χρήσεων / Brocha universal / Pennello universale / Pincel universal / Pinceau universel / Universeel kwast

**TOPEX**

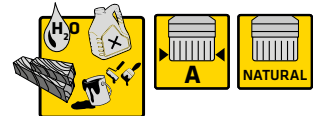

Ref.	A	☒	EAN
19B610	1"	12/600	5902062196101
19B615	1,5"	12/420	5902062196156
19B620	2"	12/240	5902062196200
19B625	2,5"	12/240	5902062196255
19B630	3"	12/180	5902062196309
19B640	4"	12/144	5902062196408

## Pędzel ławkowiec

Ceiling brush / Pinsel / Кисть-макловица / Пензель малярная / Mennyezet ecset / Pensulă de zugrav / Štětka obdélník / Štetka obdĺžniková / Čopič / Dažymo šepetėlis / Ota / Lakipintsel / Баданарка / Kist plosnati / Molerska četkica / Πινέλο βαφής / Brocha grande / Pennellesa / Pincel / Pinceau plat / Plafondkwast

**TOPEX**

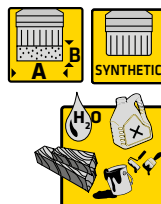

Ref.	A [mm]	B [mm]	☒	EAN
19B116	150	70	12/72	5902062191168
19B117	170	70	0/60	5902062191175
19B118	175	80	0/72	5902062191182

**TOPEX**

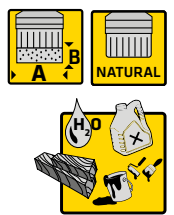

Ref.	A [mm]	B [mm]	☒	EAN
20B966	100	30	12/168	5902062005779
20B968	140	40	6/96	5902062005793
20B969	150	50	6/96	5902062005809



## Zestaw pędzli

Paint brush set / Malerpinsel / Кисти малярные / Пензли малярські, набір / Ecset készlet / Set perii vopsea / Malířské štětce / Štetec maliarsky set / Garnitura pleskarskih čopičev / Teptukai dažymui / Otu kompleks krāsošanai / Malpripintslite komplekt / Комплект четки / Set kistova / Cetka za krecenje / Πινέλα βαφής / Brochas de pintor / Pennelli da pittore / Pincéis para pintura / Pinceaux de peinture / Verfkwasten

### TOPEX

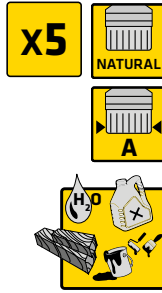

Ref.	A	☒	EAN
20B816	1"; 1.5"; 0; 2; 4	0/100	5902062006721

### TOPEX

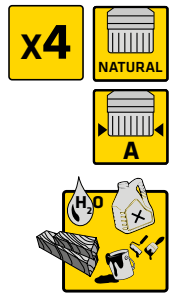

Ref.	A	☒	EAN
20B817	1"; 1.5"; 0; 4	0/100	5902062006738

## Rolka emulsiyjna

Roll for emulsion paints / Rolle, Emulsionfarbe / Роллик для водоэмульсионных красок / Роллик до емульсійних фарб / Festöhenger / Trafalet de emulsie / Emulzní váleček / Valček na emulzné farby / Valj za emulzije / Volelis emulsijos dažams / Rullītis emulsijai / Emulsioinrulli kate / Эмульсионна ролка / Valjak za emulzijske boje / Valjak za emulziju / Αναλλακτικός κύλινδρος ρολιού για πλαστικό χρώμα / Repuesto para rodillo para emulsión / Rullo per vernici ad emulsione / Rolo p. tintas de emulsão / Rouleau pour peinture émulsion / Roller voor emulsieverf

### TOPEX

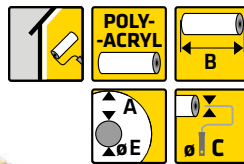

Ref.	A [mm]	B [mm]	C [mm]	E [mm]	☒	EAN
20B526	13	180	8	48	0/60	5902062006110

### TOPEX

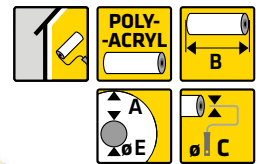

Ref.	A [mm]	B [mm]	C [mm]	E [mm]	☒	EAN
20B540	11	250	8	48	0/60	5902062006219

## Rolka fasadowa

Roll for emulsion paints / Rolle, Fassadenfarbe / Роллик фасадный / Роллик до фасадиє / Festöhenger / Trafalet de emulsie / Emulzní váleček / Valček na fasády / Valj za fasado / Volelis išorės dažymo darbam / Fasādes rullītis / Fassadairulli kate / Фасадна ролка / Valjak za fasadne boje / Valjak za fasadu / Αναλλακτικός κύλινδρος ρολιού πρόσοψης / Repuesto para rodillo para fachadas / Rullo per vernici ad emulsione / Rolo p. fachadas / Rouleau façade / Gevelroller

### TOPEX

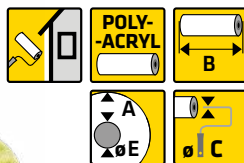

Ref.	A [mm]	B [mm]	C [mm]	E [mm]	☒	EAN
20B551	18	180	8	48	0/60	5902062006264

## Rolka olejna

Roll for oil paints / Rolle, Ölfarbe Mini / Роллик для масляных красок мини / Роллик до олійних фарб міні / Festöhenger / Trafalet de ulei / Olejový váleček mini / Valček na olejové farby / Valj za oljne barve / Volelis aliejiniams dažams / Rullītis eļļai / Mini-šlirulli kate / Блажсна ролка / Valjak za uljane boje / Valjak za ulje / Αναλλακτικός κύλινδρος μίνι ρολιού για λαδομπογιά / Repuesto para rodillo para pinturas al óleo / Rullo per vernici ad olio / Rolo p. tintas de óleo / Rouleau pour la peinture à l'huile / Roller voor olieverf

### TOPEX

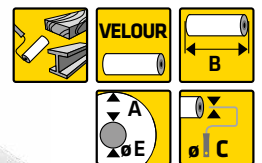

Ref.	A [mm]	B [mm]	C [mm]	E [mm]	☒	EAN
20B555	4	180	8	48	0/60	5902062006295

## Wałek emulsiyjny

Roller for emulsion paints / Welle, Emulsionfarbe / Валик для водоэмульсионных красок / Валик до емульсійних фарб / Festöhenger / Trafalet de emulsie / Emulzní váleček / Valček na emulzné farby / Valj za emulzije / Volelis emulsijos dažams / Veltnītis emulsijai / Emulsioinrull / Эмульсионен валик / Valjak - kotač za emulzijske boje / Valjak za emulziju / Ρολλό πρόσοψης / Rodillo para fachadas / Rullo con manico per vernici ad emulsione / Rolo p. tintas de emulsão / Rouleau pour peinture émulsion / Roller voor emulsieverf

### TOPEX

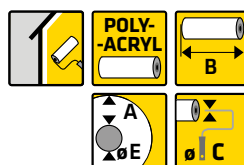

Ref.	A [mm]	B [mm]	C [mm]	E [mm]	☒	EAN
20B594	13	180	8	48	0/48	5902062005328

### TOPEX

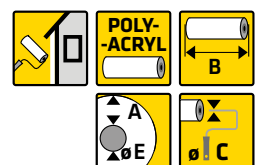

Ref.	A [mm]	B [mm]	C [mm]	E [mm]	☒	EAN
20B597	18	180	8	48	0/48	5902062005335



## Wałek olejny

Roller for oil paints / Welle, Ölfarbe / Валик для масляных красок / Валик до олійних фарб / Festöhenger / Trafalet de ulei / Olejový váleček / Valček na olejové farby / Valj za oljne barve / volelis, aliejiniams dažams / Veltnītis eļļai / Ölirull / Блажен валик / Valjak - kotača uljne boje / Valjak za ulje / Ρολλό για λαδομπογιά / Rodillo para pinturas al óleo / Rullo con manica per vernici ad olio / Rolo p. tintas de óleo / Rouleau pour la peinture à l'huile / Roller voor olieverf

**TOPEX**

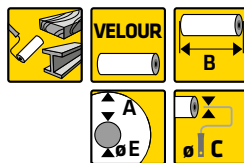

Ref.	A [mm]	B [mm]	C [mm]	E [mm]	☒	EAN
20B587	4	100	6	15	0/100	5902062006493

## Zestaw do tapetowania

Wallpapering kit / Tapetenset / Комплект для поклейки обоев / Набор для наклеивания шпалер / Tapétázókészlet / Set tapet / Tapetovacia sada / Tapetovacia sada / Kit de empapelado / Kit tappezzeria

**TOPEX**

x4



Ref.	☒	EAN
20B945	10/40	5902062508270

## Folia malarska

Covering sheet / Malerfolie / Пленка малярная / Пленка малярська / Takarófolia / Foie încheghere / Malířská fólie / Fólia zákryvacia LDPE / Zaščitna folija / Plévele dažyto darbams / Pléve krásotájam / Katterie / Покривен наїлон / Zaštitna folija / Zastitna folija / Φύλλα επικάλυψης / Plástico de protección para pintores / Telo coprente / Papel de plástico p. pintura / Film plastique de protection pour la peinture / Schilderfolie

**TOPEX**



Ref.	info	☒	EAN
23B145	0.02 mm, 4 x 5 m	0/20	5902062121660
23B175	0.007 mm, 4 x 5 m	0/50	5902062121653

## Uchwyty

Roller holder / Aufnahme für Wellen / Зажим для валиков / Тримач до валиків / Nyél festöhengerhez / Suport pentru rulouri / Držák na válečky / Objímka hriadelov / Ročaj za valje / Voleliu rankena / Veltna ietvere / Vällihoidik / Дръжка на фенерче / Drška za valjke / Hvat za valjke / Προσαρμογέας ρόουλων / Sujeción para rodillos / Impugnatura per rullo / Suporte de rolos / Manche à rouleaux / Houder voor rollers

**TOPEX**



Ref.	A [mm]	B [mm]	C [mm]	☒	EAN
20B640	180	200	8	0/48	5902062006592

## Zestaw malarski

Painter kit / Anstrich-Set / Набор маляра / Набор малярський / Festő készlet / Garnitură de vopsitorie / Malířská sada / Malárska súprava / Komplet za pleskarje / Kompletas dažytumi / Krāsotāja komplekts / Maalriekomplekt / Бояджійський комплект / Slikarski set / Pribor za slikanje / Σετ βαφεία / Juego de herramientas para pintar / Set di pittura per vernici ad emulsione / Kit p. pintura / Jeu d'outils de peinture / Verfset

**TOPEX**



Ref.	☒	EAN
20B806	0/15	5902062006653

## Kij teleskopowy

Telescopic pole / Teleskopstock / Штанга телескопическая / Ціпок телескопічний / Teleszkópos nyél / Suport telescopic / Teleskopová násada / Rukoväť teleskopická / Teleskopski ročaj / Teleskopine rankena / Pagarinātājs teleskopisks / Teleskooplatt / Дръжка телескоп. / Teleskopska ručka / Teleskopska rucka / Τηλεσκοπικός στύλος / Alargo telescópico / Manico telescópico / Pau telescópico / Tige télescopique / Teleskopisch houvast

**TOPEX**

25mm



Ref.	L [m]	☒	EAN
20B650	1 - 2	0/24	5902062005182

## Otwieracz puszek z farbą

Paint can opener / Farbosenöffner / Открывалка для банок с краской / Ключ для відкриття банок з фарбою / Festékdoboz nyitó / Deschizator de cutii cu vopsea / Otvárač na konzervy s farbami / Otvírák na plechovky s barvou / Odpiráč posod z barvo / Atidarytuvas dažų skardinėms / Krāsu bundžu atvērējs / Vārviurgjāvaja / Otvарачка за нутми с боя / Otvараč za spretnike s bojom / Otvараč za konzerve sa bojom / Ανοιχτήρι τελεκεδών μπαγιός / Abridor de latas de pintura / Apri latta / Abridor de latas de tinta / Ouvre-boîte peinture

**TOPEX**



Ref.	☒	EAN
20B671	100/300	5902062005281







# ПОМІАРОВЕ

## MEASURING ВИМІРЮВАННЯ



## Miara skládána

Wooden folding rule / Zollstock / Линејка складна / Линејка складна, дрвеняна / Famerce / Metru pliant lemn / Skládací metr / Meter skládaci / Zložljivi leseni meter / Medinis metras, sulankstomas / Metramērs saliekams / Kokkukäiv joonlaud / Метър / Drveni metar / Metar / Ξύλινο πλισσομένο μέτρο / Metro pieghevole de madera / Metro pieghevole in legno / Medidor dobrável / Mesure articulée / Vouwmeter

**NEO**  
TOOLS



MID

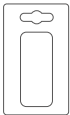

Ref.	L [m]	⊠	EAN
74-010	1	20/400	5907558400366
74-020	2	10/200	5907558400373

**TOPEX**

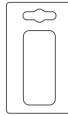

**TOP TOOLS**



Ref.	L [m]	color	⊠	EAN
26C005	1		0/200	5902062112422
26C006	2		0/284	5902062112439



Ref.	L [m]	W [mm]	⊠	EAN
26C011	1	16	24/240	5902062110015
26C012	2	16	12/120	5902062110022

## Miara zwišana

Pocket rule / Wickelmessband / Рулетка / Рулетка / Mérőszalag / Ruletă de măsurat / Měřidlo svinovací / Meter rolovací / Meter / Ruletë pënie / Mërlente rulete / Taskujoonlaud / Ponemka / Metar / Metar / Σπειρούμενη μετρητική ταινία / Flexómetro / Flessometro / Medidor enrolado / Mesure enroulée / Rolmaat

**NEO**  
TOOLS



MID

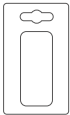

Ref.	L [m]	W [mm]	⊠	EAN
67-183	3	19	12/120	5907558425598
67-185	5	25	6/60	5907558425604
67-188	8	25	6/48	5907558425611

**NEO**  
TOOLS



MID

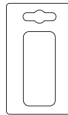

Ref.	L [m]	W [mm]	⊠	EAN
67-193	3	19	12/120	5907558425628
67-195	5	25	6/72	5907558425635
67-198	8	25	6/48	5907558425642

**NEO**  
TOOLS



MID

Compact size

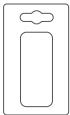

Ref.	L [m]	W [mm]	⊠	EAN
67-213	3	19	12/96	5907558425680
67-215	5	25	6/72	5907558425697
67-218	8	25	6/48	5907558425703

**NEO**  
TOOLS

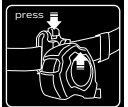

MID



**NEO**  
TOOLS



MID

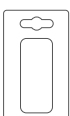

Ref.	L [m]	W [mm]	⊠	EAN
67-112	2	16	12/120	5907558400052
67-113	3	19	12/72	5907558400069
67-115	5	25	12/72	5907558400076
67-111	8	25	6/48	5907558400045

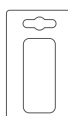

Ref.	L [m]	W [mm]	⊠	EAN
67-203	3	19	4/72	5907558425659
67-205	5	25	4/48	5907558425666
67-208	8	25	4/32	5907558425673



## Miara zwijana

Pocket rule / Wickelmessband / Рулетка / Рулетка / Mérőszalag / Rulētā de măsurat / Měřidlo svinovací / Meter rolovací / Meter / Rulētē plieninē / Mērlente rulete / Taskujoonlaud / Ponemka / Metar / Metar / Σπειρούμενη μετρητική ταινία / Flexómetro / Flessometro / Medidor enrolado / Mesure enroulée / Rolmaat

**TOPEX**

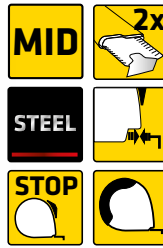

Ref.	L [m]	W [mm]	☒	EAN
27C302	2	16	10/100	5902062111760
27C303	3	16	10/100	5902062111777
27C305	5	19	10/100	5902062111784
27C308	8	25	6/48	5902062111791
27C310	10	25	6/48	5902062111807

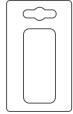

## Miara zwijana - brelok

Pocket rule - trinket / Wickelmessband / Рулетка / Рулетка кишенькова / Mini mérőszalag / Rulēta - brelok / Miara zwijana / Rolovací meter privesok / Žepni meter / Rulētē plieninē / Mērlenta / Taskujoonlaud / Metar privezak / Σπειρούμενη μετρητική ταινία / Flexómetro / Mini flessometro / Medidor enrolado / Mesure enroulée / Rolmaat - hangend

**TOPEX**

**x40**



Ref.	L [m]	☒	EAN
27C001	1	40/1200	5902062008725

**TOPEX**



Ref.	L [m]	W [mm]	☒	EAN
27C342	2	16	12/120	5902062273420
27C343	3	19	12/120	5902062273437
27C345	5	25	12/72	5902062273451
27C340	10	32	6/48	5902062273406



**TOPEX**



Ref.	L [m]	W [mm]	☒	EAN
27C383	3	16	12/120	5902062273833
27C385	5	19	6/72	5902062273857
27C387	7,5	25	6/48	5902062273871

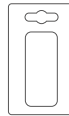

**TOP TOOLS**



Ref.	L [m]	W [mm]	☒	EAN
27C123	3	16	10/100	5902062112309
27C124	5	19	10/100	5902062112316

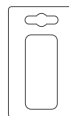

**TOP TOOLS**



Ref.	L [m]	W [mm]	☒	EAN
27C233	3	12,5	12/120	5902062111227
27C235	5	16	12/120	5902062111234

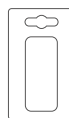

**TOP TOOLS**



Ref.	L [m]	W [mm]	☒	EAN
27C313	3	16	10/120	5902062273130
27C315	5	19	10/120	5902062273154
27C318	7,5	25	6/60	5902062273185

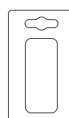

## Taśma miernicza

Measuring tape / Messband / Измерительная лента / Стричка мірна / Mérőszalag / Ruleť / Měřicí páska / Meracia páska / Merilni trak / Metras / Měrle / Měřidulint / Мерна лента / Traka za mjerenje / Traka za merenje / Метропалія / Cinta larga / Rotella metrica / Fita de medição / Ruban de mesure / Meetband

**NEO**  
TOOLS

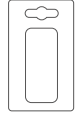

Ref.	L [m]	W [mm]	Box	EAN
68-030	30	13	10/20	5907558406696



**NEO**  
TOOLS



Ref.	L [m]	W [mm]	Box	EAN
68-050	50	13	0/20	5907558406702



**NEO**  
TOOLS

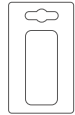

Ref.	L [m]	W [mm]	Box	EAN
68-120	20	9,5	12/48	5907558406719
68-130	30	9,5	12/48	5907558406726



**NEO**  
TOOLS



Ref.	L [m]	W [mm]	Box	EAN
68-150	50	13	20/20	5907558406733



**NEO**  
TOOLS

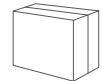

Ref.	L [m]	W [mm]	Box	EAN
68-151	50	10	5/10	5907558471748



**NEO**  
TOOLS



Ref.	L [m]	W [mm]	Box	EAN
68-051	50	13	5/20	5907558471755



**TOPEX**



Ref.	L [m]	W [mm]	Box	EAN
28C412	20	12,5	4/40	5902062112149
28C413	30	12,5	5/40	5902062112156



**TOPEX**

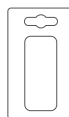

Ref.	L [m]	W [mm]	Box	EAN
28C533	30	13	0/10	5902062285331



**TOPEX**

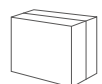

Ref.	L [m]	W [mm]	Box	EAN
28C551	100	13	0/10	5902062111975



**TOP TOOLS**



Ref.	L [m]	W [mm]	Box	EAN
28C512	20	12,5	0/64	5902062285126
28C513	30	12,5	10/40	5902062285133



## Taśma miernicza

Measuring tape / Messband / Измерительная лента / Strička merna / Mérőszalag / Ruler / Měřicí páska / Meracia páska / Merilni trak / Metras / Mērlente / Mõõdulint / Мерна лента / Traka za mjerenje / Traka za merenje / Μετρωτάνια / Cinta larga / Rotella metrica / Fita de medição / Ruban de mesure / Meetband



Ref.	L [m]	W [mm]	⊠	EAN
28C534	50	10	0/16	5902062285348

## Poziomnica

Sprit level / Richtwaage / Уровень / Рівень / Vízérték / Nivel spring / Vodováha / Vodováha / Libela / Gulsčiukas aliumininis / Limeņrādis / Lood / Нивелуп / Libela / Libela / Αλφάδι / Nivel / Livella / Nivel / Nivelle / Staand waterpas



Ref.	L [cm]	⊠	EAN
71-200	60	0/20	5907558455250

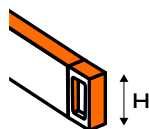

Ref.	L [cm]	H [mm]	⊠	EAN
71-112	60	65	0/30	5907558442366
71-113	80	65	0/20	5907558442373
71-114	100	65	0/20	5907558442380
71-116	150	65	0/10	5907558442397

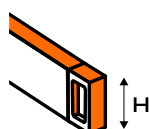

Ref.	L [cm]	H [mm]	⊠	EAN
71-122	61	60	10/50	5907558471717
71-123	61	80	10/30	5907558471724
71-124	61	100	0/30	5907558471731

## Poziomnica

Sprit level / Richtwaage / Уровень / Рівень / Vízérték / Nivel spring / Vodováha / Vodováha / Libela / Gulsčiukas aliumininis / Limeņrādis / Lood / Нивелуп / Libela / Libela / Αλφάδι / Nivel / Livella / Nivel / Nivelle / Staand waterpas

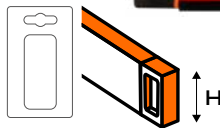

Ref.	L [cm]	H [mm]	⊠	EAN
71-001	25	44	10/60	5907558442175

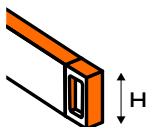

Ref.	L [cm]	H [mm]	⊠	EAN
71-030	20	56	0/30	5907558410433

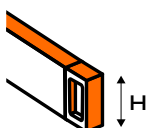

Ref.	L [cm]	H [mm]	⊠	EAN
71-061	40	50	10/60	5907558414967
71-062	60	50	10/60	5907558415971
71-063	80	50	10/40	5907558415988
71-064	100	50	10/60	5907558415995
71-065	120	50	10/20	5907558416008
71-066	150	50	0/10	5907558416015
71-067	200	50	0/10	5907558416022

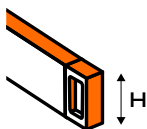

Ref.	L [cm]	H [mm]	⊠	EAN
71-081	40	51	0/40	5907558442182
71-082	60	51	0/40	5907558442199
71-083	80	51	0/40	5907558442205
71-084	100	51	0/30	5907558442212
71-085	120	51	0/20	5907558442229
71-086	150	51	0/10	5907558442236
71-087	200	51	0/10	5907558442243



Ref.	L [cm]	H [mm]	W [mm]	⊠	EAN
29C301	40	50	20	0/50	5902062293015
29C302	60	50	20	0/50	5902062293022
29C303	80	50	20	0/50	5902062293039
29C304	100	50	20	0/20	5902062293046
29C305	120	50	20	0/20	5902062293053

## Poziomnica

Sprit level / Richtwaage / Уровень / Рівень / Vízmeríték / Nivel spring / Vodováha / Vodováha / Libela / Gulsčiukas alumininis / Līmeņrādis / Lood / Høvelup / Libela / Libela / Αλφάδι / Nivel / Livella / Nivel / Nivelle / Staand waterpas

**TOPEX**



Ref.	L [cm]	H [mm]	W [mm]	☒	EAN
29C501	40	49	19	0/25	4008027040012
29C502	60	49	19	0/25	4008027040029
29C503	80	49	19	0/25	4008027040036
29C504	100	49	19	0/25	4008027040043
29C505	120	49	19	0/25	4008027040050
29C506	150	49	19	0/20	4008027040067
29C507	200	49	19	0/10	4008027040074

**TOPEX**



Ref.	L [cm]	H [mm]	W [mm]	☒	EAN
29C894	23	40	12	12/120	5902062880024

**TOP TOOLS**



Ref.	L [cm]	☒	EAN
29C893	23	24/144	5902062111623

**TOPEX**



Ref.	L [cm]	H [mm]	W [mm]	☒	EAN
29C601	40	53	24	0/25	5902062995032
29C602	60	53	24	0/25	5902062112064
29C603	80	53	24	0/25	5902062112071
29C604	100	53	24	0/25	5902062112088
29C605	120	53	24	0/25	5902062112095
29C606	150	53	24	0/20	5902062112101
29C607	200	53	24	0/10	5902062112118

**TOP TOOLS**



Ref.	L [cm]	☒	EAN
29C401	40	0/60	5902062111388
29C402	60	0/60	5902062111395
29C403	80	0/60	5902062111401
29C404	100	0/60	5902062111418

## Łata murarska

Traversing rule / Richtscheit / Правило строительное / Рейки мулярські / Ōlesléc / Dreptar (calapod) / Zednická lat' / Lata murárska / Zidarska letev / Liniuotė mūrininkui / Mūrnieka trapece / Joonlaud / Маслар / Specjalna libela / Specjalna libela / Μετρητής κλίσης / Reglón de albañil / Stadia / Remendo de pintura / Latte de maçons / Metselaarssabel

**NEO TOOLS**



Ref.	L [cm]	H [mm]	W [mm]	☒	EAN
72-523	200	100	17	0/10	5907558465235
72-524	250	100	17	0/10	5907558465242
72-525	300	100	17	0/10	5907558465259

**NEO TOOLS**



Ref.	L [cm]	H [mm]	W [mm]	☒	EAN
72-543	200	100	17	0/10	5907558481730
72-544	250	100	17	0/10	5907558481747
72-545	300	100	17	0/10	5907558481754

## Łata tynkarska

Trapezoid floating rule / Anschlaglatte / Правило штукатурное / Рейки тинькарські / Kardeczni / Rāzātoare trapezoidală / Strhovací lat' na omítku / Lata lichobežníková / Zidarska letev / Liniuotė tinkavimo darbams / Armetēja trapece / Trapetsikujuline joonlaud / Маслар / Specjalna libela / Specjalna libela / Τραπεζοειδής μετρητής υποδιαστολής / Reglón de yesero / Stadia trapezoidale / Remendo de estuque / Latte de plâtrage / Stukadoorssabel

**NEO TOOLS**



Ref.	L [cm]	H [mm]	W [mm]	☒	EAN
72-553	200	94	17	0/10	5907558465266
72-554	250	94	17	0/10	5907558465273



## Poziomnica do słupków

Post level / Wasserwaage für Pfähle / Уровень складной магнитный с шарниром / Рівень складний магнітний з шарніром / Dszlopvizmértek / Nivelă pentru montante / Sloupková vodováha / Sĺpriková vodováha / Libela za drogove / Kampinis gulsčiukas / Saliekamais magnēta līmeņrādis ar šarnīru / Postilood / Либела за стълбове / Libela za stubove / Μαγνητικό αλφάδι σωλήνων / Nivel para postes / Livella di controllo, mobile / Nivel / Nivelle à poteaux / Palenwaterpas

**TOPEX**

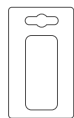

Ref.	info	☒	EAN
29C897	15-180°	0/100	5902062880154

## Poziomnica wodna

Water level / Wasserwaage / Гидроуровень / Рівень водяний / Vízmérték / Nivelă cu apă / Vodováha / Vodováha / Vodna libela / Vandens gulsčiukas / Ūdens līmeņrādis / Vesilood / Воден нивелер / Vodena libela / Libela vodena / Υδραυλικό αλφάδι / Nivel de agua / Livella ad acqua / Nivel de água / Nivelte à eau / Waterpas

**TOPEX**

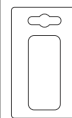

Ref.	L [m]	☒	EAN
29C871	15	0/10	5902062111982
29C872	20	0/10	5902062111999
29C873	25	0/10	5902062112002

## Poziomnica laserowa

Laser level / Laserwasserwaage / Лазерный прибор / Рівень лазерний / Lézerszintező / Nivelă cu laser / Laserová vodováha / Laserová vodováha / Laserska libela / Lazerinis lygio matuoklis / Lāzera līmeņrādis / Laserlood / Лазерна нибела / Laserska libela / Laserska libela / Αλφάδι λέιζερ / Nivel laser / Livella laser auto-livellante / Nivel de laser / Nivelte à laser / Laser waterpas

**TOPEX**

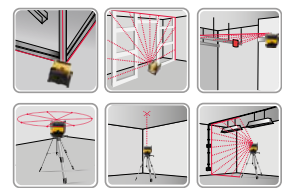

Ref.	dokładność [mm/m]	zasięg [m]	m [g]	☒	EAN
29C908	+/- 0,5	30	4,5	0/4	5902062299086

**TOP TOOLS**

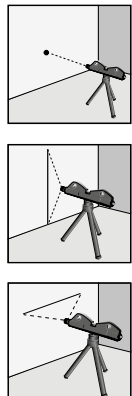

Ref.	☒	EAN
29C902	10/40	5902062889027

**TOPEX**

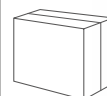
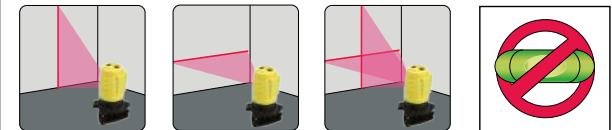

Ref.	dokładność [mm/m]	zasięg [m]	m [g]	☒	EAN
29C909	+/- 0,5	10	3,5	0/4	5902062299093



## Laser krzyżowy

Cross line laser / Kreuzlaser / Перекрестный лазер / Лазер із перехресними променями / Keresztlaser / Laser în cruce / Křížový laser / Křížový laser / Křížni laser / Kryžminis lazeris / Krustveida lāzera nivelieris / Ristlaser / Лазер с крѣтосани линии / Křížni laser / Krstasti laser / Λείζερ σταυρού / Nivel laser de líneas en cruz / Livella laser a croce / Laser de linhas cruzadas / Laser en croix / Kruislaser

**NEO**  
TOOLS



Ref. 75-100 | EAN 0/12 5907558433999

**NEO**  
TOOLS



Ref. 75-106 | EAN 0/12 5907558433960

**NEO**  
TOOLS



Ref. 75-101 | EAN 0/12 5907558434002

**NEO**  
TOOLS



Ref. 75-107 | EAN 0/12 5907558439939

## Laser płaszczynowy

Plane levelling laser / Oberflächenlaser / Лазерный построитель плоскостей / Лазер площинний / Vonallézer / Nivelă cu laser / Laser na měření rovnosti / Povrchový laser / Nivelirmi laser / Linijinis lazeris / Rotācijas lāzera nivelieris / Pinnalaser / Линеен лазер / Linijski laser / Površinski laser / Γραμμικό λέιζερ 3 επιπέδων / Nivel laser de líneas / Livella laser orizzontale / Laser linear / Laser plan / Vlaklaser

**NEO**  
TOOLS



Ref. 75-104 | EAN 0/8 5907558454406

**NEO**  
TOOLS



Ref. 75-109 | EAN 0/8 5907558454413

**NEO**  
TOOLS



Ref. 75-103 | EAN 0/12 5907558439953

**NEO**  
TOOLS



Ref. 75-108 | EAN 0/12 5907558442403





## Laser płaszczyznowy

Plane levelling laser / Oberflächenlaser / Лазерный построитель плоскостей / Лазер площинний / Vonallézer / Nivelă cu laser / Laser na měření rovnosti / Povrchový laser / Nivelirni laser / Linijinis lazeris / Rotācijas lāzera nivelieris / Pinnalaser / Линеен лазер / Linijski laser / Površinski laser / Γραμμικό λέιζερ 3 επιπέδων / Nivel laser de líneas / Livella laser orizzontale / Laser linear / Laser plan / Vlaklaser

NEO TOOLS



Ref. 75-102 | EAN 5907558433999

## Statyw

Stand / Gestell / Штатив / Штатив / Állvány / Statív / Statív / Statív / Statív / Stovas / Statīvs / Statiiv / Статив / Stativ / Βραχίονας στήριξης / Soporte / Supporto a colonna / Suporte / Bâti / Steun

NEO TOOLS



Ref. 75-110 | EAN 5907558434026

## Statyw rozporowy

Expansion pole / Expansions-Stativ / Распорный штатив / Штатив розпирний / Födémtámasz / Stativ expansiv / Rozpěrný stativ / Rozkladací statív / Stojalo / Išskleidžiamas trikojis / Teleskopiskais statīvs / Laiendatav stativ / Τελεσκοπική стойνα / Teleskopski stativ / Rasklopivo postolje / Πτυσσόμενο τρίποδο / Tripode con cangrejo / Puntella ad espansione / Tripé de expansão / Trépied entretoise / Klemstatief

NEO TOOLS

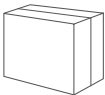

Ref. 75-113 | EAN 5907558439946

NEO TOOLS



Ref. 75-115 | EAN 5907558454468

## Dalmierz laserowy

Laser distance meter / Laser-Entfernungsmesser / Лазерный дальномер / Далекомір лазерний / Lézeres távolságmérő / Telemetru cu laser / Laserový dálkoměr / Laserový dialkometer / Laserski daljinomer / Lazerinis tolimatis / Lāzera tālmēris / Laserlood / Лазерен далекомер / Laserski daljinomer / Laserski daljinomer / Αποστάσιομετρο λέιζερ / Τελέμετρο laser / Distanziometro laser / Medidor de distància a laser / Télémètre à laser / Laser Afstandsmeter

NEO TOOLS

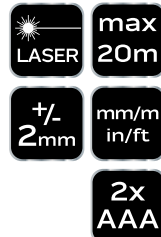
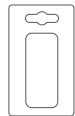

Ref. 75-202 | EAN 5907558431858

NEO TOOLS

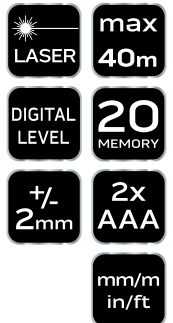
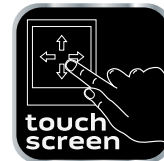
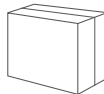

Ref. 75-203 | EAN 5907558431865

NEO TOOLS

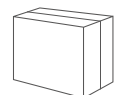

Ref. 75-204 | Ra [m] 60 | EAN 5907558463316  
Ref. 75-206 | Ra [m] 100 | EAN 5907558463323

## Odległościomierz ultradźwiękowy

Distancer / Entfernungsmesser / Дальномер / Далекомір / Ultrahangos távolságmérő / Telemetru / Dálkoměr / Dialkometer ultrazvukový / Merilec oddaljenosti / Nuotolio matuoklis / Attāluma mēritājs / Mõõdik / Далекомер / Distancer / Daljinomer / Μετρητής αποστάσεων / Medidor ultrasonidos / Misuratore di distanza / Medidor de distância / Télémètre / Afstandsmeter

TOPEX



Ref. 31C902 | L [mm] 127 | W [mm] 55 | Ra [m] 0,4 - 18 | dokt. [%] 0,5 | EAN 5902062319029



## Okulary wzmacniające widoczność lasera

Laser view enhancing glasses / Очки для улучшения видимости лазера / Окуляри для поліпшення видимости лазера / Piros lézer láthatóságát növelő szemüveg / Ochelari de mărire vizibilitate laser / Okuliare zlepšujúce viditeľnosť lasera / Brjle / Okuliare / Očala / Akiniai / Brilles / Prillid / Очила / Naočale / Naočare / Γαυλά / Gafas / Occhiali per potenziamento visibilità laser / Óculos / Lunettes / Bril

NEO  
TOOLS

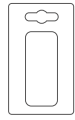

Ref. EAN  
75-120 6/120 5907558454420

NEO  
TOOLS

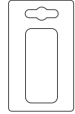

Ref. EAN  
75-121 6/120 5907558454437

## Tarcza celownicza do laserów

Target plate for lasers / Zielfafel für Laser / мишень для лазера / Цільова пластина для лазерів / Célzó tárcsa lézerhez / Placă țintă pentru lasere / Cielová doska pre lasery / Cílová deska pro lasery / Ciljna plošča za laserje / Tikslinė plokštelė lazeriams / Mērķa plāksne lāzēriem / Laserite sihtplaat / Мишень за лазеру / Ciljna ploča za lasere / Цільна плоча за ласере / Πλάτο προορισμού για λέιζερ / Placa de destino para láseres / Piastra bersaglio per laser / Placa-alvo para lasers / Plaque cible pour lasers / Richtplaat voor lasers

NEO  
TOOLS



Ref. EAN  
75-130 10/300 5907558454444



Ref. EAN  
75-131 10/300 5907558454451

## Pirometr, przyrząd do szacowania temperatury

Pyrometer, device for measuring temperature / Pyrometer, Instrument zur Temperaturschätzung / Пирометр, прибор для оценки температуры / Пирометр для оценки температуры / Pirométer, készülék hőmérséklet becslésére / Pirometru, instrument pentru estimare a temperaturii / Pyrometr, přístroj pro odhad teploty / Pyrometer, přístroj na meranie teploty / Pirometer, instrument za merjenje temperature / Pirometas, nuotolinio temperatūros matavimo prietaisas / Pirometrs, instruments temperatūras noteikšanai / Püromeeter, temperatuuri hindamise seade / Пирометър, инструмент за оценка на температурата / Pirometar, uređaj za procjenu temperature / Pirometar, instrument za procenu temperature / Πυρόμετρο, όργανο μέτρησης θερμοκρασίας / Pirómetro, instrumento para la estimación de temperatura / Pirometro, strumento di stima della temperatura / Pirómetro, ferramenta estimadora de temperatura / Pyromètre, instrument d'estimation de la température / Pyrometer, Instrument voor temperatuurschatting

NEO  
TOOLS



Ref. EAN  
75-275 0/80 5907558481761

NEO  
TOOLS



Ref. EAN  
75-276 0/60 5907558481778

## Przyrząd do szacowania temperatury

Temperature estimator / Instrument zur Temperaturschätzung / Прибор для оценки температуры / Прилад для оценки температуры / Készülék hőmérsékletbecslésre / Instrument pentru estimarea temperaturii / Přístroj pro odhad teploty / Přístroj na meranie teploty / Instrument za merjenje temperature / Temperatūros įvertinimo prietaisas / Temperatūras novērtēšanas instruments / Temperatuuri hindamise seade / Устройство за оценка на температурата / Uređaj za procjenu temperature / Instrument za procenu temperature / Όργανο μέτρησης θερμοκρασίας / Herramienta para la estimación de temperatura / Strumento di stima della temperatura / Ferramenta estimadora de temperatura / Appareil d'évaluation température / Instrument voor temperatuurschatting

NEO  
TOOLS



Ref. EAN  
75-270 0/50 5907558455267

## Drogomierz

Measuring wheel / Wegstreckenmesser / Мерное дорожное колесо / Одометр / Mérőkerék digitális / Roată de măsurat distanțe reale / Trasmòr / Meracie koliesko / Merilno kolo / Kello matuokle / Čela měritenis / Lābisoidumtōdīk / Одометър / Ciklometar / Putomer / Τροχός μέτρησης αποστάσεων / Odómetro / Rotella di misurazione / Roda de medição / Odometre (roue de mesure) / Meetwiel

TOPEX

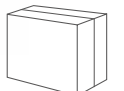

Ref. Ra [m] dokt. [%] EAN  
31C800 0,1 - 9999 0,5 0/4 5902062318008



## Wykrywacz z wyświetlaczem

Detector with display / Detektor mit Display / Детектор с дисплеем / Детектор з дисплеєм / Detektor kijelzővel / Detektor cu afişaj / Detektor s displejem / Detektor s displejom / Detektor z zaslonom / Detektorius su ekranu / Detektors ar displeju / Näidikuga detektor / Детектор с дисплеєм / Detektor s prikazom / Детектор са дисплејем / Ανιχνευτής με οθόνη / Detector con pantalla / Rivelatore con display / Detector com display / Détecteur avec affichage / Detector met display

NEO  
TOOLS

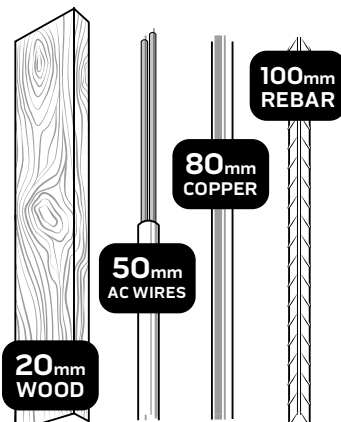

Ref. 75-250    0/40    EAN 5907558455243

## Detektor

Detector / Detektor / Детектор / Детектор / Detector / Detector / Detektor / Detektor / Detektor / Detektor / lešiklikis / Detektors / Detektor / Детектор / Detektor / Detektor / Ανιχνευτής / Detector / Rivelatore tubi/cavi elettrici/metallo / Detektor / Détecteur / Detector

TOPEX



Ref. 94W120    12/24    EAN 5902062941206

## Pion murarski

Plumb bob / Senklot / Отвес каменщика / Висок мулярський / Fügőgövs / Pírhie echilibrare / Olovnice / Olovnica / Svinčnica / Svambalas mūrīnīku / Atsvars celtniecības / Nöörlood / Отвес / Visak / Visak / Βαρίδι ήμάτος στάβρης / Plomada de albañil / Bulbo / Tubo vertical de construção / Fil à plomb de maçons / Schietlood

TOPEX

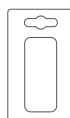

Ref. 30C643    m [g] 275    6/48    EAN 5902062110923

## Cyrkiel ślusarki

Divider / Zirkel / Циркуль / Циркуль слюсарный / Körzö / Compas pentru lăcătuş / Zámečnické kružítko / Zámečnické kružítko / Šestilo / Skriestuvas šaltkalviui / Atslēdznieka cirkulis / Lukksepasirkel / Шлюсерску нрзен / Bravarski šestar / Bravarski šestar / Διαβήτης / Compás de trazado / Compasso / Compasso p. serralharia / Compas de serrurier / Steekpasser

TOPEX

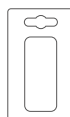

Ref. 31C701    L [mm] 210    L1 [mm] 150    Ra [mm] 0 - 160    65°    10/100    EAN 5902062317018

## Rysik traserski

Scriber / Trassierstift / Штихель трассировочный / Штихель трасувальний / Rajztű / Daltä / Nádrh / Rysovací ihla / Pisalo / Brežiklis / Krīta līnija / Märknöel / Чертилка / Griff / Igla za obeležavanje / Εργαλείο χάραξης / Punta de trazar / Tracciatore / Riscador para trazar / Pointe à tracer / Kraasnaald

TOPEX

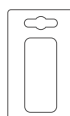
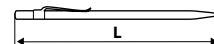

Ref. 31C703    L [mm] 150    0/300    EAN 5902062317032

## Sznurek traserski

Chalk line / Trassierschnur / Шнур трассировочный / Шнур трасувальний / Kicsarózsínór / Linie bătută cu cretă / Trasovací šňůra / Šnúrka značkovacia / Prah za označevanje / Virvë žymėjimui / Krīta līnija / Kriidimoor / Чертилка / Konac gradjevinski / Prah za obeležavanje / Σκοινί χάραξης / Cordón de trazar / Filo per peolvere tracciante / Corda p. Trazar / Fil à tracer / Metselsnoer

TOPEX



Ref. 30C630    L [m] 30    30/60    EAN 5902062306302

TOP TOOLS



Ref. 30C615    L [m] 15    0/90    EAN 5902062111852

TOP TOOLS



Ref. 30C614    L [m] 30    0/180    EAN 5902062110978



## Swmiarka

Caliper / Messschieber / Штангенциркуль / Штангенциркуль / Tolóméró / Suport / Posuvné měřítko / Meradlo posuvné / Pomíčno merilo / Slankmatis / Bīdmērs / Mōōtesirkeļ / Шублер / Pomíčno mjerilo / Pomíčno merilo / Αναλογικό παχύμετρο / Calibre / Calibro / Calibrador de corrediça / Pied à coulisse / Schuifmaat

**NEO**  
TOOLS

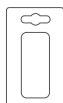
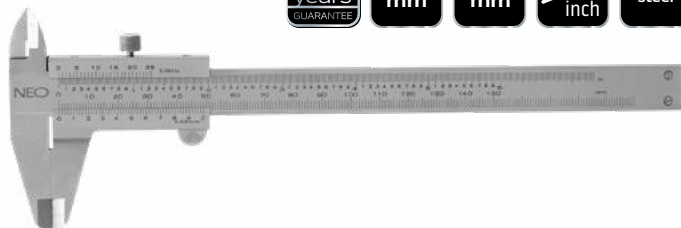

Ref.	L [mm]	Ra [mm]	⊠	EAN
75-000	234	0-150	10/10	5907558406757

**NEO**  
TOOLS

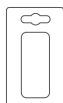

Ref.	L [mm]	Ra [mm]	⊠	EAN
75-011	237	0-150	5/25	5907558408614

**TOPEX**



Ref.	L [mm]	Ra [mm]	dokł. [mm]	⊠	EAN
31C625	290	0-200	0,02	0/50	5902062316257

**TOPEX**



Ref.	L [mm]	Ra [mm]	dokł. [mm]	⊠	EAN
31C628	235	0-150	0,02	0/50	5902062111302

**TOP TOOLS**

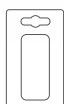

Ref.	L [mm]	⊠	EAN
31C621	150	25/100	5902062112392

**NEO**  
TOOLS

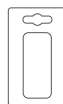

Ref.	L [mm]	Ra [mm]	⊠	EAN
75-001	230	0-150	5/25	5907558409468

**TOPEX**

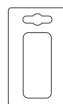

Ref.	L [mm]	Ra [mm]	dokł. [mm]	⊠	EAN
31C615	230	0-150	0,05	10/40	5902062110435
31C616	230	0-200	0,05	5/50	5902062316165

**TOPEX**



Ref.	L [mm]	Ra [mm]	dokł. [mm]	⊠	EAN
31C627	230	0-150	0,02	0/30	5902062111296

**Mikrometr**

Micrometer / Mikrometer / Микрометр / Микрометр / Microméter / Micrometru / Mikrometr / Mikrometer / Mikrometer / Mikrometros / Mikrometr / Mikromeeter / Микрометър / Mikrometer / Mikrometar / Mikrometar / Mikrometro / Micrómetro / Micrometro / Micrómetro / Micromètre / Micrometer

**TOPEX**



Ref.	L [mm]	Ra [mm]	dokł. [mm]	⊠	EAN
31C629	135	0-25	0,01	0/50	5902062111319



## Linijka kątowa

Angular ruler / Winkellineal / Угловая линейка / Кутова лінійка / Derékszög / Riglő unghiuară / Úhlové pravítko / Uhlové pravítko / Kotno ravnilo / Kampinē liniuotē / Leņķa lineāls / Nurk-joonlaud / Ёглова линия / Kutno ravnilo / Ugaoni lenjir / Γωνιακό χάρακα / Regla de ángulo / Righello ad angolo retto / Règua angular / Règle angulaire / Hoekliniaal

NEO TOOLS

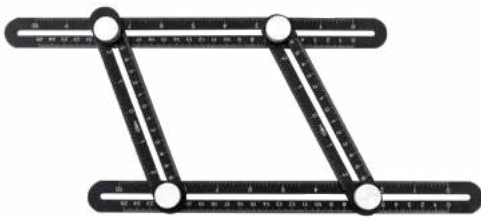

AL

cm/inch

4-sided

Ref. EAN  
72-350 10/60 5907558458787

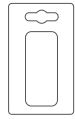

NEO TOOLS



AL

cm/inch

6-sided

2.5/4/4.5 cm

Ref. EAN  
72-351 10/60 5907558458794

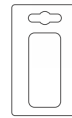

## TOPEX

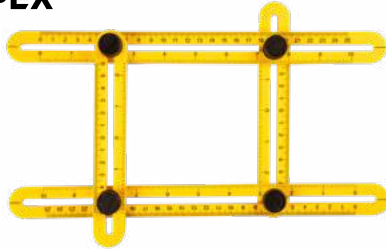

PP

HOLDUP

MULTI FUNCTION



Ref. EAN  
16B476 0/90 5902062057372

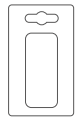

## Przymiar liniowy

Steel rule / Lineal / Линейка / Лінійка стальна / Acélvonalzó / Metru de oțel / Měřidlo / Lineál nerezový / Ravnilo / Liniuotē iš nerūdijančio plieno / Lineāls / Terasjoonlaud / Линия / Ravnilo / Lenjir / Μετροταινία / Regla de medición / Riga lineare / Calibre para cordas / Réglet / Meetlat

NEO TOOLS



AL

300 mm

1:100  
1:200

1:300  
1:400

1:500  
1:600

Ref. L [mm] EAN  
72-205 300 20/160 5907558458732

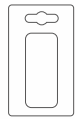

NEO TOOLS

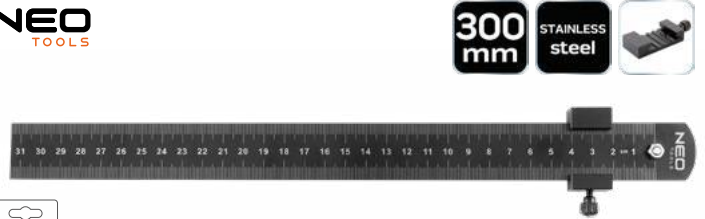

300 mm

STAINLESS steel



Ref. L [mm] EAN  
72-200 300 20/80 5907558458725

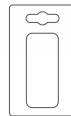

NEO TOOLS



STAINLESS STEEL

Ref.	L [mm]		EAN
72-213	300	12/300	5907558471793
72-215	500	12/120	5907558471809
72-217	750	12/120	5907558471816
72-210	1000	12/96	5907558471823



## TOPEX



Ref. L [mm] EAN  
30C217 750 10/50 5902062111180

## Κάτωνник

Square / Winkel / Угольник / Коси́нецъ / Ácsderékszög / Colțar / Úhelník / Uholník / Kotno ravnilo / Kampainis Leņķis / Vinkel / Ёгломер / Kutnik / Ugaonik / Γώνιοματς / Escuadra de techo / Profilato a l / Cantoneira / Cornière / Winkelhaak

NEO TOOLS

STEEL

DIN 875/2

PRECISION



Ref.	L [mm]		EAN
72-021	100 x 70	0/100	5907558447187
72-022	150 x 100	0/50	5907558447194
72-023	200 x 130	0/25	5907558447200
72-024	250 x 160	0/25	5907558447217
72-025	300 x 200	0/10	5907558447224

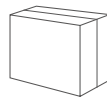

NEO TOOLS

STEEL

DIN 875/2

PRECISION



Ref.	L [mm]		EAN
72-031	100 x 70	0/100	5907558447262
72-032	150 x 100	0/50	5907558447279
72-033	200 x 130	0/20	5907558447286
72-034	250 x 160	0/25	5907558447293
72-035	300 x 200	0/10	5907558447309

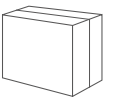

# Kątownik

Square / Winkel / Угольник / Коси́нець / Ácsderékszög / Colțar / Úhelník / Uholník / Kotno ravnilo / Καμπαινίς Λεπίς / Winkel / Ёгломер / Kutnik / Ugaonik / Γυώμονας / Escuadra de techo / Profilato a l / Cantoneira / Cornière / Winkelhaak

**NEO**  
TOOLS

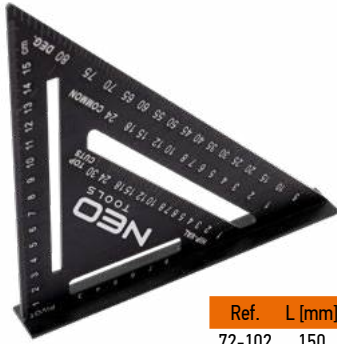

**AL**

**150 mm**

45°  
90°

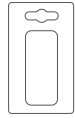

Ref.	L [mm]	⊠	EAN
72-102	150	10/80	5907558458749

**NEO**  
TOOLS



**AL**

**WITH RULER**

**150 mm**

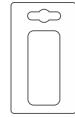

Ref.	L [mm]	⊠	EAN
72-105	150	4/24	5907558458756

**NEO**  
TOOLS



**STAINLESS steel**

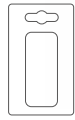

Ref.	⊠	EAN
72-109	5/40	5907558458756

**NEO**  
TOOLS

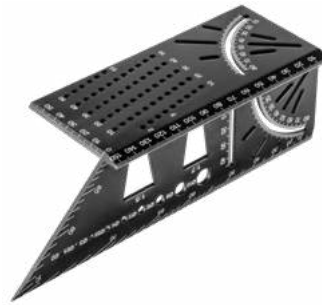

**AL**

**PRECISION**

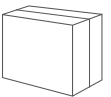

Ref.	⊠	EAN
72-115	0/60	5907558447408

**NEO**  
TOOLS



**300 mm**



Ref.	L [mm]	⊠	EAN
72-120	300	10/30	5907558447378

**NEO**  
TOOLS

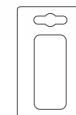
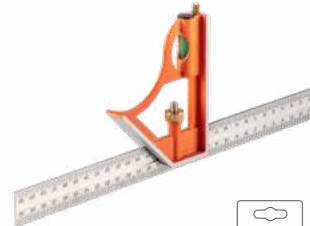

Ref.	L [mm]	⊠	EAN
72-125	300	10/60	5907558447385
72-126	600	10/60	5907558447392

**NEO**  
TOOLS



**AL**

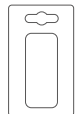

Ref.	L [mm]	⊠	EAN
72-127	300	10/40	5907558458770

**NEO**  
TOOLS



**600x400 mm**

Ref.	L [mm]	W [mm]	⊠	EAN
72-130	600	400	6/24	5902062303264

**NEO**  
TOOLS

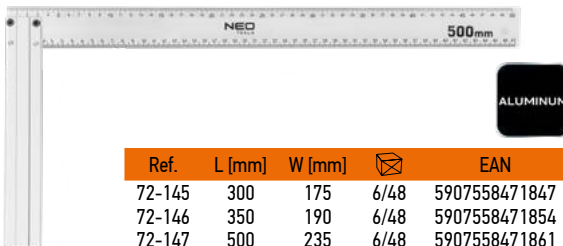

**ALUMINUM**

Ref.	L [mm]	W [mm]	⊠	EAN
72-145	300	175	6/48	5907558471847
72-146	350	190	6/48	5907558471854
72-147	500	235	6/48	5907558471861

**TOP TOOLS**

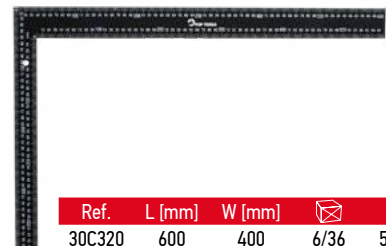

Ref.	L [mm]	W [mm]	⊠	EAN
30C320	600	400	6/36	5902062303202

**TOP TOOLS**

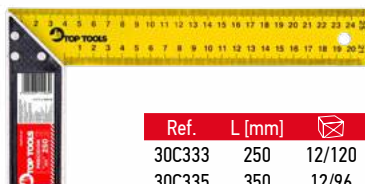

Ref.	L [mm]	⊠	EAN
30C333	250	12/120	5902062110930
30C335	350	12/96	5902062110718

**TOP TOOLS**



Ref.	L [mm]	⊠	EAN
30C330	200	20/200	5902062110916



## Kątomierz

Protractor / Winkelmesser / Угломер / Транспортир / Szögmérő / Echer réglabil / Úhloňer / Uhlomer / Kotomer / Kampainis / Leņķmērs / Nurgamōdāik / Ёгломер / Kutomjer / Uglomer / Μοιρογνωμόνιο / Escuadra / Squadra regolabile in alluminio / Transferidor regulável / Rapporteur / Gradenboog

**NEO**  
TOOLS

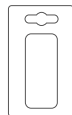

Ref.	Angle	L [mm]	L <sub>1</sub> [mm]	⊠	EAN
72-320	180°	200	100	0/200	5907558471830

**TOPEX**

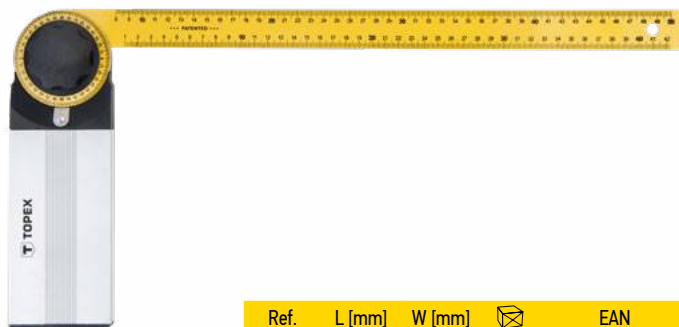

Ref.	L [mm]	W [mm]	⊠	EAN
30C343	350	210	0/10	5902062111883
30C345	500	240	0/10	5902062111890
30C347	750	340	0/10	5902062111906

**TOPEX**

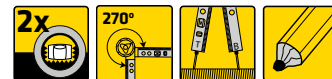

Ref.	L [mm]	W [mm]	⊠	EAN
30C321	500	500	0/10	5902062111883

## Cyfrowy miernik kąta

Digital angle gauge / Digitaler Winkelmesser / Электронный угломер / Цифровий кутомір / Digitális szögmérő / Dispozitiv de măsurare unghi digital / Digitalni úhloňer / Digitalny uholník / Digitalni meritnik kotov / Skaitmeninis kampjo matuoklis / Digitalāis leņķa mērlājs / Digitaalne nurgamōdāik / Цифров ёгломер / Digitalni kutomjer / Digitalni merač ugla / Ψηφιακός μετρητής γωνιών / Medidor digital de ángulo / Misuratore d'angolo digitale / Medidor digital de ángulos / Compteur d'angle numérique / Digitale hoekmeter

**NEO**  
TOOLS



Ref.	⊠	EAN
72-300	10/50	5907558455236





# TRANSPORT

TRANSPORTATION ТРАНСПОРТ



## System modułowy I

Modular system / Modulares System / Модульная система / Модульна система / Moduláris rendszer / Sistem modular / Modulární systém / Modulový systém / Modularni sistem / Moduline sistema / Modulu sistēma / Modulaarne süsteem / Модулна система / Modularni sustav / Модуларни систем / Αρθρωτό σύστημα / Sistema modular / Sistema modulare / Sistema modular / Système modulaire / Modulair systeem

**NEO**  
TOOLS

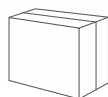
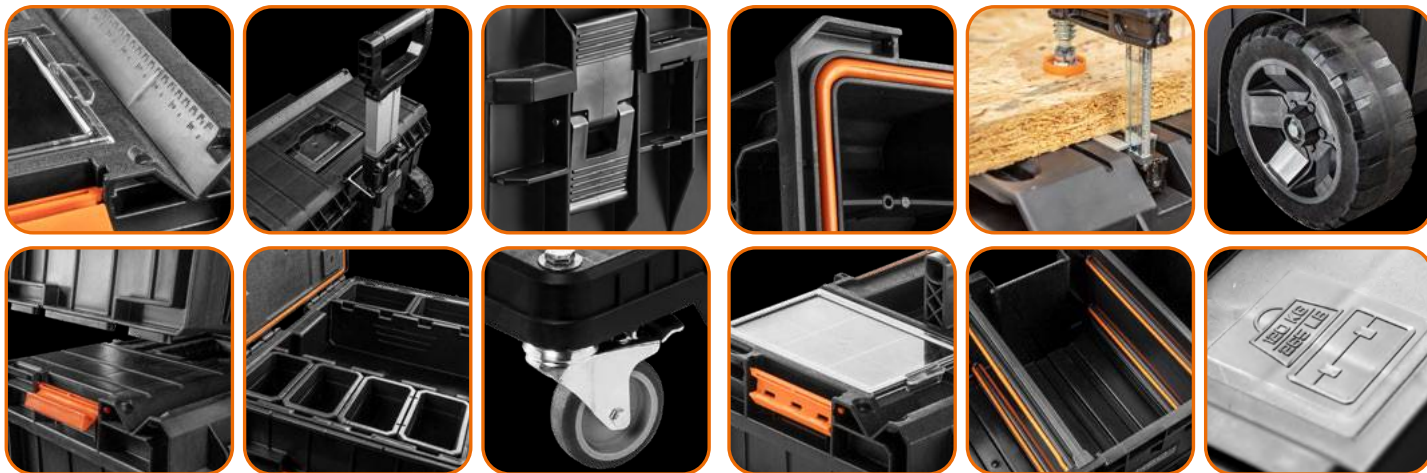

Ref.	L[mm]	W[mm]	H[mm]	☒	EAN
84-259	745	510	1020	0/1	5907558431674

## Adapter modułowy do systemu I & II

Modular adapter for I & II system / Modularer Adapter für I & II System / Модульный адаптер для системы I и II / Модульний адаптер для системи I & II / Moduláris adapter az I és II rendszerhez / Adaptor modular pentru sistemul I & II / Modulární adaptér pro systém I a II / Modulárny adaptér pre systém I a II / Modularni adapter za sistema I in II / Ir II sistemas modulinis adapteris / Modulārais adapteris I un II sistēmāi / Модулен адаптер за система I и II / Αρθρωτός προσαρμογέας για το σύστημα I & II / Adaptador modular para el sistema I y II / Adattatore modulare per sistema I e II / Adaptador modular para sistemas I & II / Adaptateur modulaire pour le système I & II / Modulaire adapter voor I & II systeem



Ref.	L[mm]	W[mm]	H[mm]	☒	EAN
84-281	600	345	74	0/1	5907558485233



## System modułowy I

Modular system / Modulares System / Модульная система / Модульна система / Moduláris rendszer / Sistem modular / Modulární systém / Modulový systém / Modularni sistem / Moduline sistema / Modulu sistema / Modulaarne süsteem / Модулна система / Modularni sustav / Модуларни систем / Αρθρωτό σύστημα / Sistema modular / Sistema modulare / Sistema modular / Système modulaire / Modulair systeem

**NEO**  
TOOLS



Ref.	L[mm]	W[mm]	H[mm]	☒	EAN
84-276	585	460	765	0/1	5907558443608



Ref.	L[mm]	W[mm]	H[mm]	☒	EAN
84-278	585	460	765	0/1	5907558443622



Ref.	L[mm]	W[mm]	H[mm]	☒	EAN
84-266	585	460	765	0/1	5907558433968



Ref.	L[mm]	W[mm]	H[mm]	☒	EAN
84-257	585	385	422	0/1	5907558431650



Ref.	L[mm]	W[mm]	H[mm]	☒	EAN
84-256	585	385	322	0/1	5907558431643



Ref.	L[mm]	W[mm]	H[mm]	☒	EAN
84-255	585	385	190	0/1	5907558431636



Ref.	L[mm]	W[mm]	H[mm]	☒	EAN
84-269	450	260	224	0/1	5907558443592



Ref.	L[mm]	W[mm]	H[mm]	☒	EAN
84-267	576	259	237	0/1	5907558433975



Ref.	L[mm]	W[mm]	H[mm]	☒	EAN
84-350				0/1	5907558459708



Ref.	L[mm]	W[mm]	H[mm]	☒	EAN
84-268	585	385	131	0/1	5907558443585



Ref.	L[mm]	W[mm]	H[mm]	☒	EAN
84-286	264	364	77	1/1	5907558446470



Ref.	L[mm]	W[mm]	H[mm]	☒	EAN
84-287	531	379	77	1/120	5907558446487



## System modułowy II

Modular system / Modulares System / Модульная система / Модульна система / Moduláris rendszer / Sistem modular / Modulární systém / Modulový systém / Modularni sistem / Modulnè sistema / Modulu sistēma / Modulaarne süsteem / Модулна система / Modularni sustav / Модуларни систем / Αρθρωτό σύστημα / Sistema modular / Sistema modulare / Sistema modular / Système modulaire / Modulair systeem

**NEO**  
TOOLS



Ref.	L[mm]	W[mm]	H[mm]	☒	EAN
84-066	530	380	690	1/1	5907558450118



Ref.	L[mm]	W[mm]	H[mm]	☒	EAN
84-061	530	310	225	1/1	5907558450064



Ref.	L[mm]	W[mm]	H[mm]	☒	EAN
84-064	530	295	195	1/1	5907558450095



Ref.	L[mm]	W[mm]	H[mm]	☒	EAN
84-062	530	380	690	0/1	5907558450071



Ref.	L[mm]	W[mm]	H[mm]	☒	EAN
84-060	530	310	130	1/1	5907558450057



Ref.	L[mm]	W[mm]	H[mm]	☒	EAN
84-065	257	182	65	1/1	5907558450101



## Skrzynka narzędziowa

Tool box / Werkzeugkasten / Ящик для инструмента / Скриня інструментальна / Szerszámláda / Cutie scule / Nářadová skříňka / Basa na náradie / Škatla za orodje / Įrankių dėžė / Instrumentu koferis / Tööriistakast / Куфар за инструменти / Kutija za alat / Kutija za alat / Εργαλειοθήκη / Caja de herramientas / Valigetta elettricista modulare / Caixa p. ferramentas / Caisse à outils / Gereedschapskist

**NEO**  
TOOLS

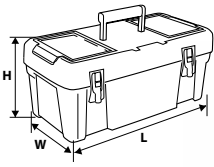

Ref.	L [mm]	W [mm]	H [mm]	☒	EAN
84-102	460	240	255	0/1	5907558409574
84-105	545	280	270	0/1	5907558408683

**NEO**  
TOOLS

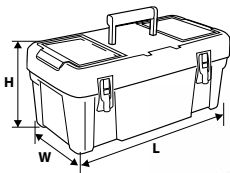

Ref.	L [mm]	W [mm]	H [mm]	☒	EAN
84-114	495	360	710	0/1	5907558439182

**NEO**  
TOOLS



**STEEL**

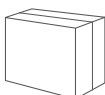
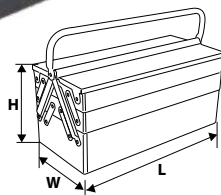

Ref.	L [mm]	W [mm]	H [mm]	m [kg]	☒	EAN
84-100	460	220	210	4,3	1/1	5907558409437
84-101	550	220	210	5	1/1	5907558409444

## Skrzynka narzędziowa na kołach

Tool box with wheels / Werkzeugkasten / Ящик для инструмента с колесами / Скриня інструментальна / Szerszámkocsi / Cutie scule / Nářadová skříňka / Basa na náradie / Škatla za orodje / Įrankių dėžė / Instrumentu koferis / Tööriistakast / Куфар за инструменти / Kutija za alat / Kutija za alat / Εργαλειοθήκη / Caja de herramientas / Carrello porta utensili / Caixa p. ferramentas / Caisse à outils / Gereedschapskist

**NEO**  
TOOLS

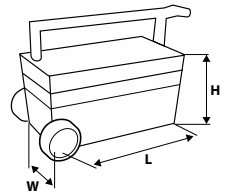

Ref.	L [mm]	W [mm]	H [mm]	☒	EAN
84-116	680	400	355	0/1	5907558421699

## Warsztat mobilny

Mobile workshop / Werkzeugkasten / Мобильная мастерская / Скриня інструментальна / Szerszámkocsi / Cutie scule / Nářadová skříňka / Basa na náradie / Škatla za orodje / Įrankių dėžė / Instrumentu koferis / Tööriistakast / Куфар за инструменти / Kutija za alat / Kutija za alat / Εργαλειοθήκη / Caja de herramientas / Carrello porta utensili / Caixa p. ferramentas / Caisse à outils / Gereedschapskist

**NEO**  
TOOLS

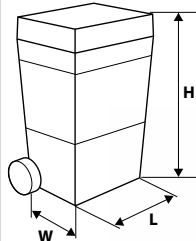

Ref.	L [mm]	W [mm]	H [mm]	☒	EAN
84-115	495	360	710	0/1	5907558421682



## Skrzynka narzędziowa

Tool box / Werkzeugkasten / Ящик для инструмента / Скриня інструментальна / Szerszámláda / Cutie scule / Nářadová skříňka / Basa na náradie / Škatla za orodje / Įrankių dėžė / Instrumentu koferis / Tööriistakast / Купар за инструменти / Kutija za alat / Kutija za alat / Εργαλειοθήκη / Caja de herramientas / Valigetta elettrica modulare / Caixa p. ferramentas / Caisse à outils / Gereedschapskist

**T** TOPEX

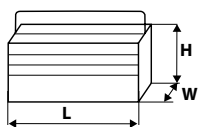

Ref.	L [cm]	W [cm]	H [cm]	📦 [kg]	📦	EAN
79R100	40	20	21	3,4	0/1	5902062200396
79R101	55	20	21	4,4	0/1	5902062200402

**T** TOPEX

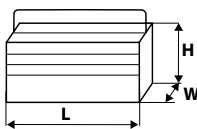

Ref.	L [cm]	W [cm]	H [cm]	📦 [kg]	📦	EAN
79R102	55	20	27	5,5	0/1	5902062200419

**T** TOPEX

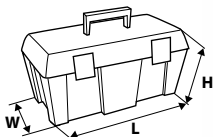

Ref.	["]	L [cm]	W [cm]	H [cm]	📦	EAN
79R129	25	60	29	33	0/1	5902062791290

**T** TOPEX

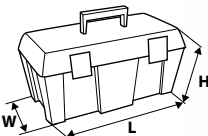

Ref.	["]	L [cm]	W [cm]	H [cm]	📦	EAN
79R120	12	29	14	15	0/1	5902062791207
79R121	16	38	17	17	0/1	5902062791214
79R122	18	44	22	22	0/1	5902062791221

**T** TOPEX

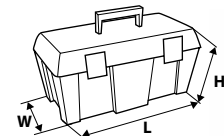

Ref.	["]	L [cm]	W [cm]	H [cm]	📦	EAN
79R123	12	29	14	15	0/1	5902062791238
79R124	16	38	17	17	0/1	5902062791245
79R125	18	44	22	22	0/1	5902062791252

**T** TOPEX

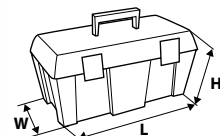

Ref.	L [cm]	W [cm]	H [cm]	📦	EAN
79R131	37,4	18,9	19,8	0/1	5902062997661

## Walizka

Case / Koffer / Чемоданчик / Скриня/валіза / Szerszámostáska / Geantă / Kufřík / Kufřík / Kovček / Lagaminas / Čemodáns / Kohver / Купарче / Kofer / Kofer / Βαλιτάκι / Maletin / Casseta in alluminio / Mala / Valise / Koffer

**T** TOPEX

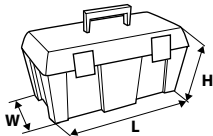

Ref.	L [cm]	W [cm]	H [cm]	📦	EAN
79R132	46,2	24,2	25,6	0/1	5902062997678
79R133	54,7	27,1	27,8	0/1	5902062997685

**T** TOPEX

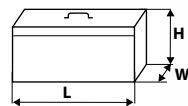

Ref.	L [cm]	W [cm]	H [cm]	📦 [kg]	📦	EAN
79R220	45	15	32	2,4	0/4	5902062792204



## Organizer

Organizer / Organizer / Организаёр / Организаёр / Szortimenter / Organizer / Organizér / Organizér plast. na spoj. materiál / Škatla za orodje / Systeineris / Sikumkaste / Säilituskast / Организаёр / Kutija za alat / Kutija za alat / Organizer / Organizador / Organiser / Agenda / Organiseur / Organizer



12 wymiowych pojemników  
12 removable containers  
12 съёмные контейнеры



Antyustrząsowe narożniki  
Anti-shake corners  
Антивибрационные углы



Poliwęglanowa pokrywa  
Polycarbonate cover  
Поликарбонатная крышка



Aluminiowe zapięcie  
Aluminum clasp  
Алюминиевая застёжка

**NEO**  
TOOLS



Ref.	info	📦	EAN
84-130	40 x 40 x 12 cm	0/1	5907558431216



8 wymiowych pojemników  
8 removable containers  
8 съёмные контейнеры

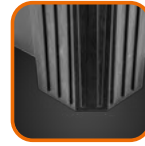

Antyustrząsowe narożniki  
Anti-shake corners  
Антивибрационные углы



Poliwęglanowa pokrywa  
Polycarbonate cover  
Поликарбонатная крышка



Aluminiowe zapięcie  
Aluminum clasp  
Алюминиевая застёжка

**NEO**  
TOOLS



Regulowane przegrody  
Adjustable dividers  
Регулируемые отсеки



Ref.	info	📦	EAN
84-131	39 x 60 x 11 cm	0/1	5907558431223

**NEO**  
TOOLS

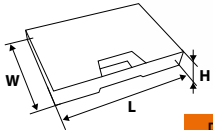

Ref.	L [mm]	W [mm]	H [mm]	📦	EAN
84-118	390	290	65	0/1	5907558439229
84-119	490	390	65	0/1	5907558439236

**TOPEX**

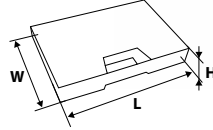

Ref.	L [cm]	W [cm]	H [cm]	📦	EAN
79R160	46	33	11	0/1	5902062791603

**TOPEX**



Ref.	L [cm]	W [cm]	H [cm]	📦	EAN
79R163	36	25	5,5	0/1	5902062791634

**TOPEX**

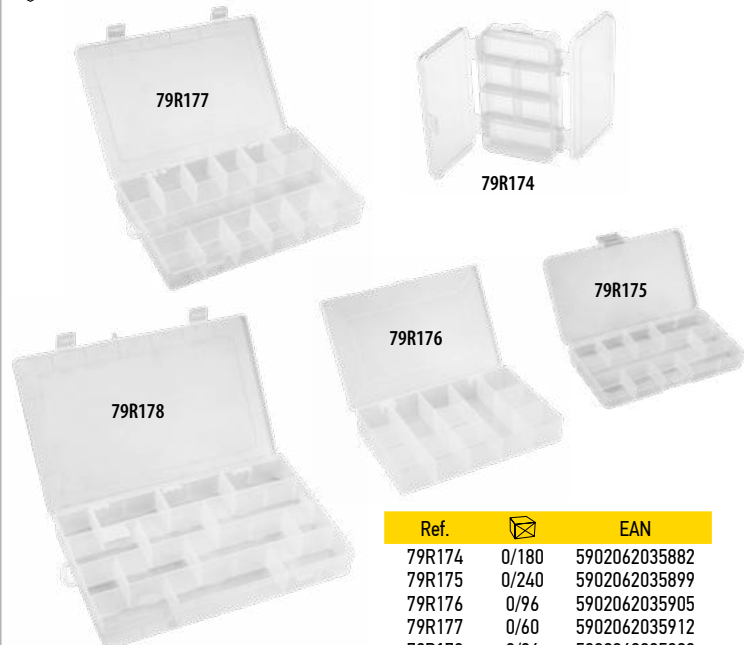

Ref.	📦	EAN
79R174	0/180	5902062035882
79R175	0/240	5902062035899
79R176	0/96	5902062035905
79R177	0/60	5902062035912
79R178	0/36	5902062035929



## Plecak monterski

Tool backpack / Monteurrucksack / Рюкзак монтерский / Рюкзак монтерський / Szerszámós hátizsák / Rucsac pentru mecanic / Batoh na náradí / Plecniak na náradie / Nahrbtnik za orodje / Montuotojo jrankiý kupriné / Instrumentu mugursoma / Tööriistade seljakott / Монтьорска раница / Rusak za montere / Monterski ranac / Σάκος εργαλείων / Mochila de montador / Zaino porta utensili / Mochila para ferramentas / Sac à dos porte-outils / Monteur rugzak

**NEO**  
TOOLS



POLYESTER  
600D

Ref. EAN  
84-304 0/6 5907558425833

## Plecak monterski na kořah

Tool backpack with wheels / Monteurrucksack mit Rädern / Рюкзак монтерский на колесах / Рюкзак монтерський на коліщатах / Szerszámós hátizsák / Rucsac pe roți pentru mecanic / Batoh na náradí na kolečkách / Plecniak na náradie na kolieskach / Nahrbtnik za orodje na kolesih / Montuotojo jrankiý kupriné su ratukais / Instrumentu mugursoma uz ritepiem / Tööriistade seljakott, ratastega / Монтьорска раница на кола / Rusak za montere s kotačima / Monterski ranac sa točkicama / Σάκος εργαλείων με ρόδες / Mochila de montador sobre ruedas / Trolley/zaino in tela / Mochila para ferramentas com rodas / Sac à dos porte-outils à roulettes / Monteur rugzak op wielen

**NEO**  
TOOLS



POLYESTER  
600D

Ref. EAN  
84-303 0/2 5907558425826

## Torba monterska

Tool bag / Monteurtasche / Сумка монтерская / Торба інструментальна / Szerszámtáska csődalakú fém fogantyúval / Geanta scule / Monterská brašna / Taška monterska kožená / Torba za orodje / Monterio krepšys / Instrumentu soma / Tööriistakott / Нуфар за инструменти / Torba za alat / Torba za alat / Σάκος για εργαλεία / Bolsa para herramientas / Borsa per meccanico / Saco p. montagem / Sac de monteur / Montagetas

**NEO**  
TOOLS



POLYESTER  
600D

Ref. EAN  
84-301 0/2 5907558425802

**NEO**  
TOOLS



POLYESTER  
600D

Ref. EAN  
84-308 0/4 5907558427745

**NEO**  
TOOLS



20"

NYLON  
600D

Ref. EAN  
84-300 0/4 5907558417258

**NEO**  
TOOLS



NYLON  
600D

Ref. EAN  
84-305 0/6 5907558417265



## Torba monterska

Tool bag / Monteurtasche / Сумка монтерская / Торба інструментальна / Szerszámtáska csőalakú fém fogantyúval / Geanta scule / Montérská brašna / Taška montérska kožená / Torba za orodje / Monterio krepšys / Instrumentu soma / Tööriistakott / Кудар за инструменти / Torba za alat / Torba za alat / Σάκος για εργαλεία / Bolsa para herramientas / Borsa per meccanico / Saco p. montagem / Sac de monte / Montagetas

**NEO**  
TOOLS



Ref.  EAN  
84-315 0/35 5907558428391



**T TOPEX**

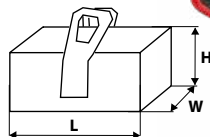

Ref. L [cm] W [cm] H [cm]  EAN  
79R440 41 23 23 0/4 5902062794406

**T TOPEX**

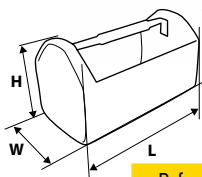

Ref. L [cm] W [cm] H [cm]  EAN  
79R444 42 22 24 0/4 5902062794444

**T TOPEX**

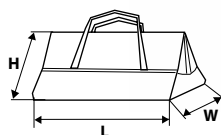

Ref. L [cm] W [cm] H [cm]  EAN  
79R441 46 30 33 0/12 5902062794413

**T TOPEX**

**HEAVY DUTY**



Ref.  EAN  
79R204 0/60 5902062036797





## Torba monterska na kołach

Tool bag with wheels / Monteurtasche / Монтерская сумка на колесах / Торба монтерська на коліщатах / Szerszámtáska / Geantă pe roți pentru mecanic. / Taška na nářadí na kolečkách / Taška na náradie na kolieskach / Torba za orodje na kolesih / Montuotojo krepšys su ratukais / Instrumentu soma uz ritepiem / Tööriistakott, ratastega / Монтьорска торба на колена / Torba za montere s kotačima / Monterska torba sa točkicama / Τσάντα εργαλείων με ρόδες / Bolsa de montador sobre ruedas / Trolley in tela / Bolsa para ferramentas com rodas / Sac porte-outils à roulettes / Monteurstas op wielen

**NEO**  
TOOLS



POLYESTER  
600D

Ref.	📦	EAN
84-302	0/2	5907558425819

**TOPEX**



Ref.	📦	EAN
79R449	0/5	5902062034151

## Stołek z torbą monterską

Chair with tool bag / Sitz mit Monteurtasche / Табурет складной с монтерской сумкой / Столик із монтерською торбою / Szerszámtáska szék funkcióval / Scăunăș cu geantă pentru mecanic / Skládací židle s taškou na nářadí / Stolik s taškou na náradie / Mizaica s torbo za orodje / Staliukas su montuotojo krepšiu / Taburete ar instrumentu somu / Tööriistakotiga laud / Табуретка с моньорска торба / Stolica s torbom za montere / Stolica sa monterskom torbom / Πτυσσόμενο ακαμνάκι με τσάντα εργαλείων / Silla con bolsa de montador / Seggiolino pieghevole con borsa / Banco com bolsa para ferramentas / Sac à outils avec siège pliant / Kruk met monteurstas

**NEO**  
TOOLS



POLYESTER  
600D

Ref.	📦	EAN
84-306	0/10	5907558425796

**TOPEX**



**HEAVY  
DUTY**

Ref.	📦	EAN
79R447	0/10	5902062034137

## Saszetka

Waist bag / Gürteltasche / Поясная сумка / Торба на паску / Övtáska / Borseta / Ledvinka / Ladvinka / Pasma torbica / Déklas / Jostas soma / Vöökott / Паласка / Pasma torbica / Torbica / Τσανάκι μέσης / Riñonera / Marsupio porta utensili / Bolsa / Sacoche porte-outils à ceinture

**NEO**  
TOOLS



Ref.	📦	EAN
84-311	0/70	5907558428377

## Kamizelka monterska

Tool jacket / Monteurstweste / Жилет монтажника / Жилетка з кишенями для інструмента / Szerszámtartó mellény / Įvelis protekcije pentru unelte / Montérská vesta / Vesta montérska / Jakna za orodje / Monterio liemenė / Montiera veste / Tööriistavest / Елек монтьорска / Prsluk za alat / Torba za alat / Σακάκι τεχνική / Chaleco portaherramientas / Gilet portoutensili / Colete para montagem / Gilet de monteur / Gereedschapsvest

**TOPEX**



Narzędzia nie są dołączone  
Tools are not included  
Продається без інструменту

Ref.	📦	EAN
79R255	0/30	5902062792556



## Pas do kabur

Plicer belt / Monteurriemen / Пояс монтерский / Pas dla instrumenty / Őv szerszámtáskákhoz / Bandă adezivă / Montérský pás / Opasok na náradie / Pas za orodje / Monterio diržas / Instrumentu josta / Liimimispressi lint / Колан за инструменту / Pojas za alat / Pojas torbica / Ζώνη μονταρίσματος / Cinturón para herramientas reforzado / Cintura / Cinto p. montagem / Ceinture de monteur / Montageriem

**NEO**  
TOOLS



PVC  
1680D

400  
g/m<sup>2</sup>

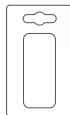

Ref.	📦	EAN
84-335	50/100	5907558421941

## Pas do kabur i kieszeni

Belt for holsters and pouches / Gurte mit Werkzeugtaschen / Пояс для инструмента / Pas dla ciplianja kabur i кишень / Őv szerszámtáskákhoz / Curea cu tocuri și buzunare / Pás na pouzdra a kapsy / Pás na puzdra a vrecká / Pas z žepi za orodje / Diržas deklėms ir kišenėms / Instrumentu sikсна / Rihm kabuuride ja taskute kinnitamiseks / Колан за кобура и джобовете / Pas za futrolu i džep / Kaiš za kaburu i džepove / Ζώνη εργαλείων / Cinturón para pistoleras y bolsas / Cintura per tasche per utensili / Cinto para estojos e bolso / Ceinture à gaines et poches / Riem voor holsters en zaken

**TOPEX**

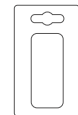

Ref.	L [cm]	📦	EAN
79R410	70 - 140	0/100	5902062794109

## Pas monterski

Plicer belt / Monteurriemen / Пояс монтерский / Pas dla instrumenty / Szerszámtáskás övvel / Bandă adezivă / Montérský pás / Opasok na náradie / Pas za orodje / Monterio diržas / Instrumentu josta / Liimimispressi lint / Колан за инструменту / Pojas za alat / Pojas torbica / Ζώνη μονταρίσματος / Cinturón para herramientas reforzado / Cintura porta utensili / Cinto p. montagem / Ceinture de monteur / Montageriem

**NEO**  
TOOLS

x12

PVC  
1680D

400  
g/m<sup>2</sup>

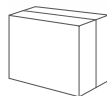

Ref.	📦	EAN
84-330	0/5	5907558415667

**TOPEX**

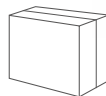

Ref.	L[cm]	📦 [kg]	📦	EAN
79R402	86 - 120	1,3	0/5	5902062794024

Narzędzia nie są dołączone  
Tools are not included  
Продається без інструменту

**TOPEX**



Ref.	L [cm]	📦	EAN
79R405	94 - 120	0/25	5902062794055

**TOP TOOLS**

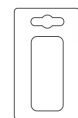

Ref.	📦	EAN
79R401	0/50	5902062207784

## Uchwyt na młotek

Hammer holder / Aufnahme für Hammer / Зажим для молотка / Тримач до молотка / Kalapács tartó / Suport pentru ciocan / Držák na kladívko / Upínadlo kladiva / Vpetje za kladivo / Plaktuko rankena / Āmura ietvere / Vasarahoidik / Дръжка на чук / Drška za čekić / Hvata za čekić / Προσαρμολογείσ αφυριού / Sujeción para martillo / Gancio per martello / Manche de martelet / Houder voor hamer

**NEO**  
TOOLS

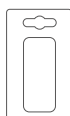

Ref.	📦	EAN
84-332	50/100	5907558415681

PVC  
1680D

400  
g/m<sup>2</sup>

**TOPEX**

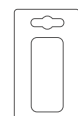

Ref.	📦	EAN
79R420	0/100	5902062794208

Narzędzia nie są dołączone  
Tools are not included  
Продається без інструменту



## Kieszonka na narzędzia

Tool pocket / Werkzeugtasche / Сумка для инструментов / Карман для инструмента / Szög és szerszámtartó / Buzunar pentru scule / Kapsa na nářadí / Vrecko na nářadí / Žep za orodja / Deklas įrankiams / Instrumentu somiņa / Тööriistatasku / Преградка за инструментти / Futrola za alate / Džep za alat / Τοάντα εργαλείων / Portaherramientas / Marsupio porta utensili / Bolso p. ferramentas / Poche à outils / Gereedschapszak

**NEO**  
TOOLS



x4

PVC  
1680D

400  
g/m<sup>2</sup>

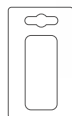

Ref. 84-333    0/50    EAN 5907558415698

**NEO**  
TOOLS



x8

PVC  
1680D

400  
g/m<sup>2</sup>

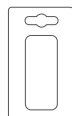

Ref. 84-334    20/40    EAN 5907558415704

**TOPEX**

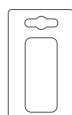

Narzędzia nie są dołączone  
Tools are not included  
Продается без инструмента

Ref. 79R431    0/50    EAN 5902062794314

**TOPEX**

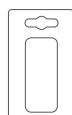

Narzędzia nie są dołączone  
Tools are not included  
Продается без инструмента

Ref. 79R432    0/40    EAN 5902062794321

**TOPEX**

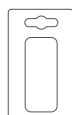

Narzędzia nie są dołączone  
Tools are not included  
Продается без инструмента

Ref. 79R430    0/50    EAN 5902062794307

**TOPEX**

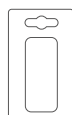

Narzędzia nie są dołączone  
Tools are not included  
Продается без инструмента

Ref. 79R421    0/100    EAN 5902062794215

## Kabura

Holster / Halfter / Кобура / Кобыра / Szerszámtartó övtáska / Carcasa / Kožené pouzdro / Púzdro na vřtačku / Torbica za orodja / Deklas / Instrumentu josta / Kabuur / Кальф за бормашина / Torbica za bušilicu / Torbica za alat / Πιστολιθήκη / Pistolera para herramientas eléctricas / Fondina per elettrotensili / Estajo / Gaine / Holster

**TOPEX**

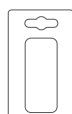

Narzędzia nie są dołączone  
Tools are not included  
Продается без инструмента

Ref. 79R415    0/12    EAN 485902062794154

**TOPEX**

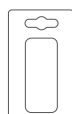

Narzędzia nie są dołączone  
Tools are not included  
Продается без инструмента

Ref. 79R416    0/100    EAN 5902062794161



## Materiałowe etui na narzędzia

Textile tool case / Werkzeugkoffer aus Stoff / Текстовые чехлы для инструментов / Текстильні чохли для інструментів / Textil szerszámtartó / Husă textilă pentru scule / Materiálové pouzdro na náradí / Materiálové pouzdro na náradie / Etui iz blaga za orodje / Medžaginis įrankių dėklas / Auduma arvalki instrumentiem / Kangas tööriistavutlar / Платнен налф за инструменти / Etui za alat / Kutije za alat / Υφασμάτινη θήκη εργαλείων / Estuche textil para las herramientas / Valigetta per utensili in tessuto / Estujo téxtil para as ferramentas / Trousse rangement des outils en tissu / Stoffen gereedschapsetui

**NEO**  
TOOLS



22  
POUCHES

UNIVERSAL

Ref. 09-890 0/40 EAN 5907558458923

## Stolek składany

Foldable stool / zusammenklappbarer Hocker / Табурет складной / Стільчик складаний / Összesukható sámlí / Taburet pliant / Skládací stolička / Skladací stolček / Zložljiva pručka / Sulankstoma kėdutė / Saliekamgalds / Kokkuradav laud / Съваема масичка / Sklopiva stolica / Stolic na rasklapanje / Πτυσσόμενο ακαμνάκι / Banco plegable / Tavolino pieghevole / Banco dobrável / Escabeau / Kantelbare kruk

**TOPEX**

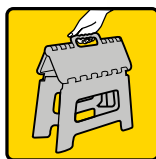

22  
cm

150  
kg

Ref. 79R319 0/12 EAN 5902062793188

## Perforacja narzędziowa

Tool wall / Werkzeuglochung / Панель перфорированная для инструментов / Панель інструментальна / Szerszámossal / Suport perete pentru unelte / Perforace pro uchycení držáků nářadí / Panel na náradie / Stenski regal / Sienele įrankiams / Instrumentu plaukts / Tööriistaalus / Перфорация на инструменти / Perforirani organizer za alate / Polica za alat / Τοίχος για εργαλεία / Tablero organizador para herramientas / Perforazione per attrezzi / Perfuração de ferramentas / Plaques perforées pour outils / Gereedschapswand

**NEO**  
TOOLS

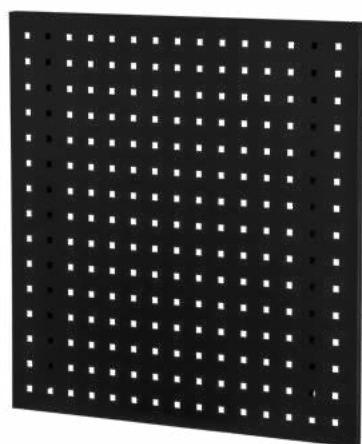

60 cm  
60 cm  
± 2 cm

steel  
thickness  
0.8  
mm

steel  
cold  
SPCC

includes  
WALL  
PLUGS

Ref. 84-500 H [mm] 600 W [mm] 600 D [mm] 20 0/1 EAN 5907558454253

**NEO**  
TOOLS

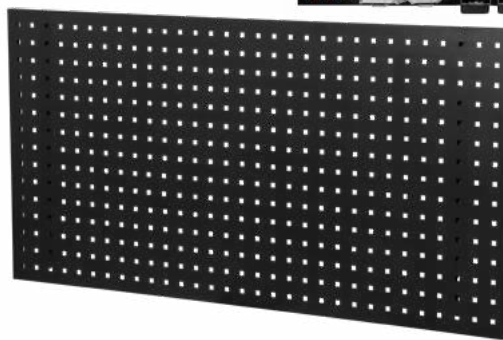

120 cm  
60 cm  
± 2 cm

steel  
thickness  
0.8  
mm

steel  
cold  
SPCC

includes  
WALL  
PLUGS

Ref. 84-501 H [mm] 600 W [mm] 1200 D [mm] 20 0/1 EAN 5907558454260

## Hak na pojemnik

Hooks / Hacken / Крюки / Гаки / Horgok / Cârlițe / Håky / Skoby / Kļjuke / Kabliai / Āķi / Haagid / Кукки / Kuke / Кукке / Γάντζοι / Ganchos / Ganci / Anzóis / Crochets / Haken

**NEO**  
TOOLS



steel  
cold  
SPCC

steel  
thickness  
1.0  
mm

10x6  
cm

Ref. 84-502 250/250 EAN 5907558454277

**NEO**  
TOOLS



steel  
cold  
SPCC

steel  
thickness  
1.0  
mm

13x6.5  
cm

Ref. 84-503 250/250 EAN 5907558454284

## Listwy magnetyczne

Magnetic tool holders / Magnetische Werkzeughalter / Держатели магнитных инструментов / Магнітні тримачі інструментів / Mágneses szerszámtartók / Suporturi de scule magnetice / Magnetické držáky nástrojů / Magnetické držáky nástrojov / Magnetna držala za orodje / Magnetinių įrankių laikikliai / Magnētisko instrumentu turētāji / Magnetiliste tööriistade hoidjad / Магнитни държачи за инструменти / Magnetski držači alata / Magneti držači alata / Μαγνητικά εργαλεία στήριξης / Portaherramientas magnéticas / Portautensili magnetici / Porta-ferramentas magnéticas / Porte-outils magnétiques / Magnetische gereedschapshouders

**NEO**  
TOOLS

x3



Ref. 84-144 6/12 EAN 5907558449006



## Pojemnik magazynowy

Store container / Magazinbehälter / Складской контейнер / Контейнер / Alkatrész tartó láda / Recipient de depozit / Skladovací boxy / Skladovacia nádoba / Predalnik / Skyrelis dėžutė / Naliktavu konteineris / Ηοιμαhυτι / Машинен контейнер / Spremnik za skladište / Kontejner za skladištenje / Δοχείο αποθήκευσης / Cubeta de almacenaje / Contenitore impilabile / Recipiente de armazém / Réceptient de magasin / Opslagcontainer

**TOPEX**



Ref.	L [cm]	W [cm]	H [cm]	☒	EAN
79R182	17	11,5	7,5	0/1	5902062791825
79R183	25	16	13	0/1	5902062791832
79R184	36	22,5	16,5	0/1	5902062791849

## Perforacja narzędziowa

Tool wall / Werkzeuglochung / Панель перфорированная для инструментов / Панель инструментальна / Szerszámartó fal / Scule perete / Perforace pro uchycení držáků nářadí / Panel na náradie / Stenski regal / Sienelė įrankiams / Instrumentu plaukts / Tööriistaalus / Перфорация на инструменти / Perforirani organizer za alate / Polica za alat / Τοίχος για εργαλεία / Tablero organizador para herramientas / Tavola organiser per utensili / Perforação de ferramentas / Plaques perforées pour outils / Gereedschapswand

**TOPEX**



Ref.	L [cm]	H [cm]	☒	EAN
79R186	80	50	0/9	5902062791863

## Haki

Hooks / Hacken / Крюки / Ганги / Horgok / Cârlige / Hákы / Skoby / Kljčke / Kabliai / Āķi / Haagid / Кукы / Kuke / Kuke / Гάντζοι / Ganchos / Ganci / Anzóis / Crochets / Haken

**NEO TOOLS**



Ref.	☒	EAN
84-142	6/12	5907558448986

**NEO TOOLS**

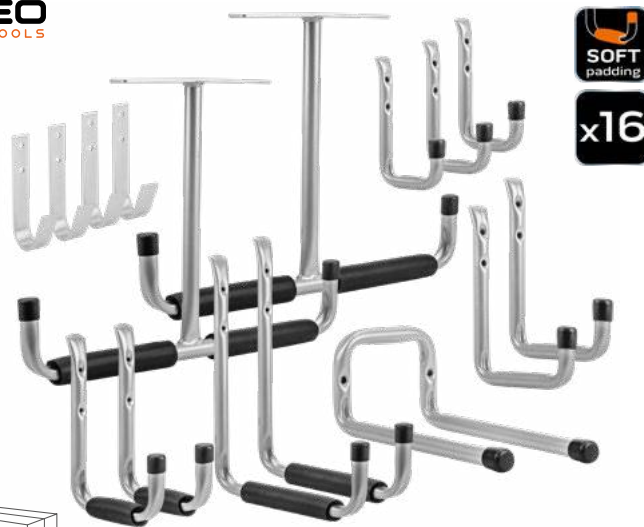

Ref.	☒	EAN
84-143	6/12	5907558448993

## Worki na odpady, mocne

Strong waste bags / Beutel für Abfall, fest / Мешки для отходов, прочные / Мішки для відходів, міцні / Szemetesszak / Saci p/t reziduri, rezistente / Pytle na odpad, silné / Vrečia na odpad, pevné / Vreče za odpadke, močne / Šiuokšlių maišai, stiprūs / Atkritumu maisi, izturīgi / Jäätmekotid, tugevad / Чувалы за отпадзцы, сільны / Vreče za odpad, čvrste / Kесе за отпад, јаке / Σάκοι αποβλήτων ανθεκτικοί / Bolsas de residuos, resistentes / Sacchi per rifiuti / Sacos para residuos, fortes / Sacs pour ordures, résistants, / Afvalzakken, sterk

**TOPEX**



**x10**

**SUPER STRONG**

Ref.	Q [l]	[µm]	☒	EAN
23B258	120	40	0/30	5902062009012
23B259	240	45	0/10	5902062009029

**TOPEX**

**x5**

**SUPER STRONG**



Ref.	Q [l]	[µm]	☒	EAN
23B257	80	100	0/15	5902062009005



## Wózek transportowy

Multipurpose trolley / Transportwagen / Тележка грузозавозная / Візок транспортувальний / Molnárkocsi / Cărucior de transport / Převravný vozík / Prepravný vozík / Transportni vozíček / Maišelis transportavimui / Ratiņi / Veokāru / Транспортна колица / Transportna kolica / Transportna kolica / Καρότσια μεταφοράς / Carretilla de transporte / Carrello di trasporto / Carrinho de transporte / Chariot de manutention / Transportwagen

**NEO**  
TOOLS

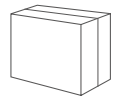

Ref. EAN  
84-405 0/1 5907558485509

**NEO**  
TOOLS

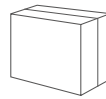

Ref. EAN  
84-402 0/1 5907558431612

**NEO**  
TOOLS

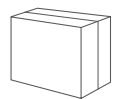

Ref. EAN  
84-401 0/1 5907558431605

**NEO**  
TOOLS

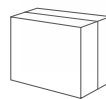

Ref. EAN  
84-403 0/1 5907558431629

**T TOPEX**

ALUMINIUM

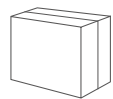
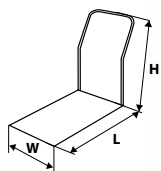

Ref. L [cm] W [cm] H [cm] max [kg] [kg] EAN  
79R300 50/70 42 65 150 7,5 0/1 5902062207746

**T TOPEX**

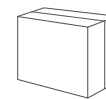
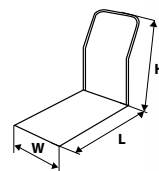

Ref. L [cm] W [cm] H [cm] max [kg] [kg] EAN  
79R301 72 47 82 150 8,9 0/1 5902062793010



## Wózek transportowy

Multipurpose trolley / Transportwagen / Тележка грузозная / Візок транспортувальний / Molnárkocsi / Cărucior de transport / Přepravný vozík / Prepravný vozík / Transportni voziček / Maišelis transportavimui / Ratiņi / Veokāru / Транспортна колица / Transportna kolica / Transportna kolica / Καρότσια μεταφοράς / Carretilla de transporte / Carrello di trasporto / Carrinho de transporte / Chariot de manutention / Transportwagen

**TOPEX**

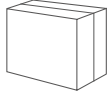

Ref.	L [cm]	W [cm]	max [kg]	[kg]	0/1	EAN
79R305	35	18,5	120	5,4	0/1	5902062042248

**TOPEX**

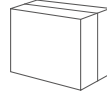

Ref.	L [cm]	W [cm]	max [kg]	[kg]	0/1	EAN
79R302	43	42	90	4,8	0/1	5902062810106

**TOPEX**



Ref.	max [kg]	[kg]	0/6	EAN
79R306	35	2,75	0/6	5902062042255

## Platforma transportowa

Transport platform / Транспортная платформа / Platforma de transport / Anyagmozgató kocsi / транспортна платформа / Dopravná plošina / Transportní plošina / Transportplattform / Transportna platforma / Transporta platforma / Transporta platforma / Transportdiplavorm / Транспортна платформа / Transportna platforma / Транспортна платформа / Πλατφόρμα μεταφοράς / Plataforma de transporte / Piattaforma di trasporto / Plataforma de transporte / Plateforme de transport / Transportplattform

**NEO TOOLS**

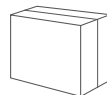

Ref.	capacity [kg]	0/6	EAN
84-141	200	0/6	5907558448979

## Ściągacze do bagażu

Luggage tie down straps / Герпäckbefestigung / Зажимные болты для багажа / Багажні пасу зумои / Csomagrögztű / Dispozitiv de scosbagaje / Stahovací pásy na zavazadla / Upínacie lano "panúk" / Elastične vrvi / Kroviniji tvirtinimo sprauštuvai / bagāžas saspieđejskrūves / Коортаџмитсад / Ремъци за багаж / skidači prtjag / Skidači za prtjag / Ιμάντες ασφάλισης αποσκευών / Correas elásticas para maletas / Cinghie elastiche per bagagli / Ponta de aperto de bagagem / Sangles de bagage / Trekkers voor bagage

**TOP TOOLS**



x12

Ref.	0/12	EAN
97X206	0/12	5902062972064

**TOP TOOLS**



x2

Ref.	L [cm]	0/6	EAN
97X198	80	72/144	5902062170170
97X199	100	40/120	5902062170187



## Таśма do багажу

Luggage strap / Герăкбанд / Лента для багажа / Стрїчка багажна / Rakotmányrögzítő / Bandă de bagaje / Popruh na zavazadla / Pás na náklady / Trak za prtljago / Krovinių tvirtinimo juosta / Bagāžas lente / Koormarihmad / Лента за багаж / Traka za prtljagu / Traka za prtljag / Ταβία αποσκευών / Cinta para maleta / Cinghie con cricchetto / Fita p. Bagagem / Bande à bagage / Bagageband

**NEO**  
TOOLS

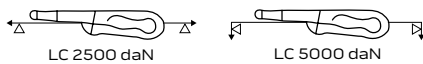

Ref.	KG	L [m]	W [mm]	☒	EAN
84-140	2500 / 5000	5	50	0/10	5907558448962

## TOPEX

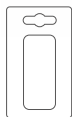

Ref.	L [m]	W [mm]	x N	☒ [kg]	☒	EAN
97X185	7,0	50	1	1,6	0/10	5902062971852
97X186	4,5	30	2	1,7	0/10	5902062971869

## TOPEX

x2

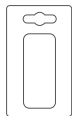

Ref.	L [m]	W [mm]	☒	EAN
97X183	2,5	25	0/80	5902062971838
97X184	5,0	25	0/50	5902062971845

## TOP TOOLS

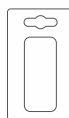

Ref.	L [m]	W [mm]	☒	EAN
97X192	6	50	0/24	5902062992000

## TOP TOOLS

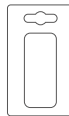

Ref.	L [m]	W [mm]	☒	EAN
97X195	5	25	0/36	5902062171344

## Plandeka

Taraulin / Plane / Брезентовая покрывка / Тент брезентовый / Takarórpunya / Prelatä / Plachta / Plachta zakryvacia / Cerada / Brezentas / Pärvalks / Present / Брезентово покрывало / Cerada / Cerada / Μουσαμάς / Lona / Telone impermeabile / Lona / Bäche / Doek

## TOPEX

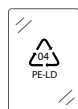

PE

70  
[g/m²]

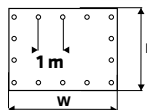

Ref.	L [m]	W [m]	☒	EAN
79R355	3	4	0/20	5902062793553
79R356	4	6	0/10	5902062793560
79R357	5	8	0/6	5902062793577

## TOPEX



PE

85  
[g/m²]



Ref.	L [m]	W [m]	☒	EAN
79R364	5	8	0/6	5902062793645
79R365	6	10	0/4	5902062793652
79R367	10	15	0/1	5902062793676

## TOP TOOLS



60  
g/m²

PE



Ref.	L [m]	W [m]	☒	EAN
79R351	3	4	0/20	5902062793515
79R352	4	6	0/10	5902062793522

## Ośłona przewodów

Cable tube / Kabelabdeckung / Οργαναίзер для проводов / Кабель-канал / Kábel csatorna / Aprtoare de cabluri / Trubice pro vedení kabelů / Kryt na kábale / Pokryvalo za kabel / Kabelij arsauga / Kabelu aizsegs / Juhtmekate / Спирала бандажна за кабелен снап / Fleksibilna zaštita kablova / Zaštita za kabl / Σπράλά οργανώσης καλωδίων / Espiral para cables / Tubo per cavo / Protecção de cabos / Protection range-câbles

## TOPEX

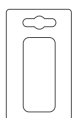

Ref.	L [mm]	Ø [mm]	☒	EAN
79R273	200	20	0/50	5902062004567
79R274	200	25	0/40	5902062004574
79R275	200	30	0/30	5902062004581







# ŁĄCZENIE

## JOINING З'ЄДНАННЯ



# Zszywacz

Stapler / Heftmaschine / Cmennep / Cmennep / Tűzőgép / Capsator / Sešivačka / Spunkovačka / Spenjač / Kabiamašis / Skavu pistole / Klammerdaja / Takep / Klamérica / Heftalica / Μηχανή συρραφής / Grapadora / Cucitrice / Máquina de pontear / Agrafeuse / Hechtmaschine

**NEO**  
TOOLS

ALUMINIUM  
BODY

4  
in 1

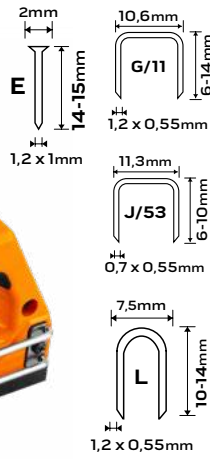
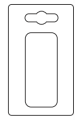

Ref. 16-030 EAN 6/12 5907558454680

**NEO**  
TOOLS

3  
in 1  
P+/-

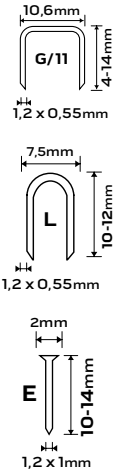
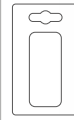

Ref. 16-031 EAN 6/24 5907558454697

**NEO**  
TOOLS

P+/-

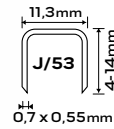
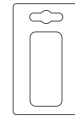

Ref. 16-032 EAN 6/24 5907558454703

**NEO**  
TOOLS

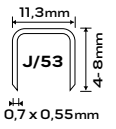
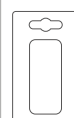

Ref. 16-033 EAN 6/24 5907558454710

**T TOPEX**

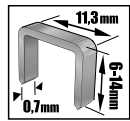

typ J

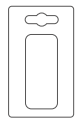

P+/-

J/53  
6-14mm

METAL  
BODY

Ref. 41E906 EAN 20/40 5902062031594

**T TOPEX**

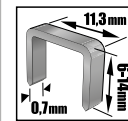

typ J

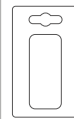

P+/-

J/53  
6-14mm

METAL  
BODY

Ref. 41E905 EAN 20/40 5902062030634

**T TOPEX**

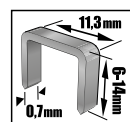

typ J

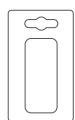

J/53  
6-8mm

METAL  
BODY

Ref. 41E903 EAN 20/40 5902062030580

**T TOPEX**

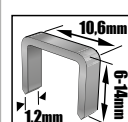

typ G

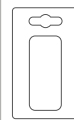

P+/-

G/11  
6-14mm

METAL  
BODY

Ref. 41E908 EAN 20/40 5902062419088



## Zszywacz

Stapler / Heftmaschine / Сменлер / Сменлер / Túzógép / Capsator / Sešivačka / Sponkovačka / Spenjač / Kabiamašis / Skavu pistole / Klammerdaja / Такер / Klamerica / Heftalica / Μηχανή συρραφής / Grapadora / Cucitrice / Máquina de pontear / Agrafeuse / Hechtmaschine

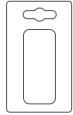

Ref.	Type J	☒	EAN
41E904	4 - 14 mm	10/40	5902062031228

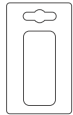

Ref.	Type J	☒	EAN
41E901	4 - 8 mm	15/60	5902062030016

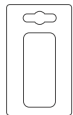

Ref.	Type J	☒	EAN
41E915	4 - 8 mm	5/15	5902062021069

## Rozszywacz

Staple remover / Klammerentferner / Антисменлер / Засіб для видалення скоб / Túzó eltávolító / Remover de capse / Odstraňovač sponiek / Odstraňovač sponiek / Odstranjivalec sponk / Susegimo vališkis / Skavu porēmšanas līdzeklis / Klambrite eemaldaja / Антисменлоб / Alat za ukljanjanje spajalica / Уклањанье снајамлица / Αφαιρέση συνβητρών / Quitagrapas / Levapunti / Removedor de grampos / Dégrafeur / Ontnieter /

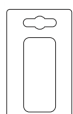

Ref.	☒	EAN
16-040	10/80	5907558454734

## Zszywacz młotkowy

Hammer stapler / Hammerhefter / Сменлер молотковый / Молоток сменлер / Kalapács tűzó / Capsator cu ciocan / Sešivačka kladiva / Sešivačka kladiva / Spenjalnik kladiva / Plaktuko segiklis / Āmura skavotājs / Klambripūstol haamri / Теллоб с чук / Hemer klamerica / Cekić heftalica / Συρραπτικό σφυρί / Grapadora de martillo / Cucitrice a martello / Grampeador de martelo / Agrafeuse à marteau / Hamer nietmachine

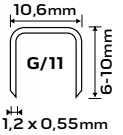
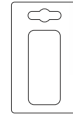

Ref.	☒	EAN
16-034	6/24	5907558454727

## Zszywki

Staples / Klammern / Скобы / Скобу / Túzókapocs / Capsator / Sešivací spony / Sponky / Sponke / Kabés / Skavas / Klambrič / Телъема / Municija za klamericu / Heftalica / Συρραπτήρες / Grapas / Punti metallici / Pontas / Agrafes / Hechters

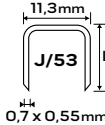
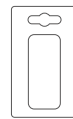
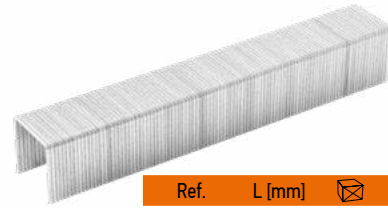

Ref.	L [mm]	☒	EAN
16-506	6	10/180	5907558401493
16-508	8	16/144	5907558401509
16-510	10	20/180	5907558401516
16-512	12	20/90	5907558401523
16-514	14	10/90	5907558401530

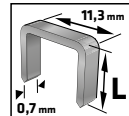

Ref.	L [mm]	N	☒	EAN
41E306	6	x1000	20/200	5902062030436
41E308	8	x1000	20/200	5902062030443
41E310	10	x1000	20/200	5902062202499
41E312	12	x1000	20/200	5902062202772
41E314	14	x1000	20/200	5902062202505

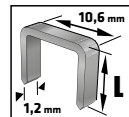

Ref.	L [mm]	N	☒	EAN
41E406	6	x1000	0/200	5902062414069
41E408	8	x1000	0/100	5902062414083
41E410	10	x1000	0/100	5902062414106
41E412	12	x1000	0/100	5902062414120
41E414	14	x1000	0/100	5902062414144

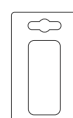

Ref.	Type	L [mm]	N	☒	EAN
41E006	J	6	x1000	50/300	5902062031310
41E008	J	8	x1000	50/200	5902062031327
41E010	J	10	x1000	45/180	5902062031334
41E012	J	12	x1000	30/180	5902062031341
41E014	J	14	x1000	30/150	5902062031358



## Pistolet klejowy

Glue gun / Leimpistole / Пистолет клеющій / Пистолет клеющій / Ragasztópisztoly / Pistol de lipit / Lepící pistole / Pištol lepiaca / Lepilna pištola / Ključ pistoletas / Limes pistole / Liimpistool / Пистолет за силикон / Pištolj za plastiku / Pistol za plastiku / Πιστόλι θερμοκόλλησης / Pistola surtidora de pegamento / Pistola incallitrice a caldo / Pistola p. Cola / Pistolet à colle / Liimpistol

**NEO**  
TOOLS



Ref. Ø [mm] ☒ EAN  
17-083 11,2 0/10 5907558462524

**NEO**  
TOOLS



Ref. Ø [mm] ☒ EAN  
17-084 8 10/30 5907558465655

**NEO**  
TOOLS



Ref. Ø [mm] ☒ EAN  
17-090 11,2 5907558465686

**NEO**  
TOOLS



Ref. Ø [mm] ☒ EAN  
17-095 8 24/48 5907558465642

**NEO**  
TOOLS



Ref. Ø [mm] ☒ EAN  
17-096 11,2 12/36 5907558465679

**NEO**  
TOOLS



Ref. Ø [mm] ☒ EAN  
17-097 11,2 12/36 5907558465693

**NEO**  
TOOLS



Ref. Ø [mm] ☒ EAN  
17-100 11,2 0/20 5907558465648

**TOPEX**



Ref. Ø [mm] ☒ EAN  
42E511 11,2 0/12 5902062425119



## Pistolet klejowy

Glue gun / Leimpistole / Пистолет клеєвий / Пистолет клеїловий / Ragasztópisztoly / Pistol de lipit / Lepící pistole / Pištol lepiaca / Lepilna pištola / Ključ pistoletas / Limes pistole / Liimpüstol / Пистолет за силикон / Pištolj za plastiku / Pistolj za plastiku / Πιστόλι θερμοκόλλησης / Pistola surtidora de pegamento / Pistola incallatrice a caldo / Pistola p. Cola / Pistolet à colle / Lijmpistool

**TOPEX**



**78**  
P<sub>max</sub>[W]  
**11**  
Ø [mm]  
CE

Ref.	P [W]	q [g/min]	⊠	EAN
42E501	25/78	12-18	10/40	5902062091130

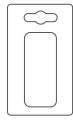

**TOPEX**



**10**  
P<sub>max</sub>[W]  
**8**  
Ø [mm]  
CE

Ref.	P [W]	q [g/min]	⊠	EAN
42E580	10	3	12/48	5902062013538

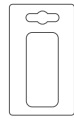

**TOPEX**



**200**  
P<sub>max</sub>[W]  
**11**  
Ø [mm]  
CE

Ref.	P [W]	q [g/min]	⊠	EAN
42E521	20/200	12	12/48	5902062425218

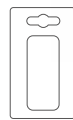

**TOPEX**



**200**  
P<sub>max</sub>[W]  
**11**  
Ø [mm]  
CE

Ref.	P [W]	q [g/min]	⊠	EAN
42E522	20/200	15	12/48	5902062425225

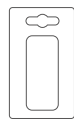

**TOP TOOLS**



Ø **11,2 mm**

CE

Ref.	Ø [mm]	q [g/min]	⊠	EAN
42E500	11,2	8 - 12	12/24	5902062130099

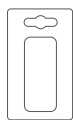

**TOP TOOLS**



Ø **8 mm**

CE

Ref.	Ø [mm]	q [g/min]	⊠	EAN
42E581	8	6 - 8	24/48	5902062130105



## Wkłady klejowe

Glue sticks / Leimpatronen / Стержни клеєвые / Стержни клеїлові / Ragasztópatron átlátszó fehér / Mandrină de lipit / Tyčinky lepidla / Tyčky lepiace / Lepilo v palicah / Ključ lazdeles / Limes stobriņi / Liimpulgad / Силикон на пръчки / PVC štariči / PVC štariči / Φυσίγια θερμοκόλλας / Cartuchos de pegamento / Sticks di colla / Cartuchos de colle / Lijmstift

**NEO**  
TOOLS

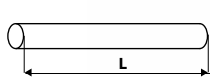

**11.2 mm**  
**300 mm**

Ref.	Ø [mm]	L [mm]	kg	⊠	EAN
17-154	11	300	2	0/12	5907558465112
17-155	11	300	5	0/1	5907558465129

**NEO**  
TOOLS



**x12**  
11,2 mm <250 mm>  
**300g** 180°C  
Icons: glue gun, glue stick, glue stick in gun, glue stick in box, glue stick in box

Ref.	Ø [mm]	L [mm]	N	color	⊠	EAN
17-172	11	250	x12	white	25/50	5907558465136
17-173	11	250	x12	black	0/50	5907558465143
17-113	11	250	x12	white	25/50	5907558465204



## Wkłady klejowe

Glue sticks / Leimpatronen / Стержни клеювые / Стружні клеюові / Ragasztópatron átlátszó fehér / Mandriná de lipit / Тужкы лепidla / Тужкы лепiace / Lepilo v palicah / Ključ lazdelés / Limes stobirni / Liimpulgad / Силунок на пръчки / PVC štápicí / PVC štápicí / Φουσίγια θερμακόλας / Cartuchos de pegamento / Sticks di colla / Cartuchos de cola / Cartouches de colle / Lijmstift

**NEO**  
TOOLS

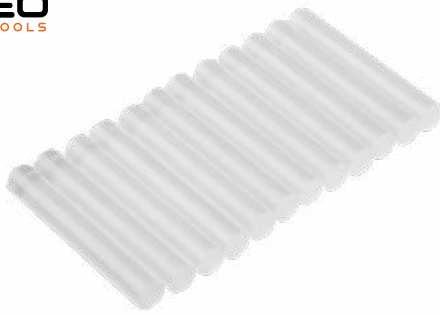

Ref.	Ø [mm]	L [mm]	N	color	⊠	EAN
17-180	8	250	x12			5907558465150

**TOPEX**

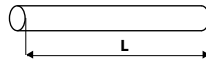

Ref.	Ø [mm]	L [mm]	N	color	⊠	kg	⊠	EAN
42E113	11	250	x12			0,300	0/50	5902062130402
42E171	11	250	x12			0,300	10/50	5902062130419
42E172	11	250	x12			0,300	0/50	5902062130426
42E173	11	250	x12			0,300	0/50	5902062130433

**TOPEX**

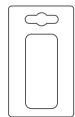
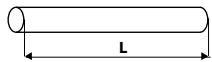

Ref.	Ø [mm]	L [mm]	N	color	⊠	EAN
42E180	8	100	x12			5902062013545

**TOPEX**

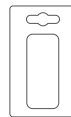
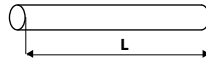

Ref.	Ø [mm]	L [mm]	color	⊠	EAN
42E181	8	100		100/200	5902062000057
42E182	8	100		100/200	5902062000064

**TOP TOOLS**

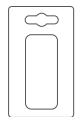
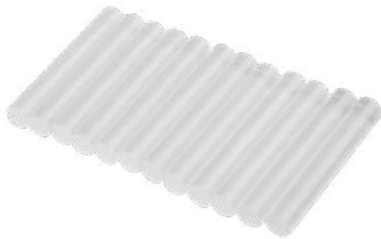

Ref.	Ø [mm]	L [mm]	N	color	-kg	⊠	EAN
42E081	8	50	x12		0,031	0/500	5902062130136
42E110	11,2	100	x6		0,060	0/200	5902062130204

**TOP TOOLS**



Ref.	Ø [mm]	L [mm]	N	color	-kg	⊠	EAN
42E151	11,2	200	x50		1,000	0/12	5902062130594
42E152	11,2	200	x100		2,000	0/8	5902062130587

## Nitownica

Riveter / Nietmaschine / Заклепочник / Клепальний інструмент / Popszegecszűző / Mašinà de nituit / Nytovačka / Kliešte nitovacie oceľové / Pištola za kovčenje / Kniediklis / Kniežu stangas / Needitangid/ Нутачка / Klijesta za zakovice / Pistolj za pop nitne / Нлч / Remachadora / Rivettatrice / Rebitadora / Riveuse / Klinknagelmachine

**NEO**  
TOOLS



	Ø 2,4/3,0/3,2/4,0/4,8/5,0 mm		Ø 2,4/3,0/3,2/4,0/4,8/5,0 mm
	Ø 2,4/3,0/3,2/4,0/4,8/5,0 mm		Ø 2,4/3,0/3,2/4,0 mm

Ref.	Ø [mm]	L [mm]	⊠	EAN
18-101	2,4/3,2/4,0/4,8	264	10/30	5907558400137

**NEO**  
TOOLS



	Ø 2,4/3,0/3,2/4,0/4,8/5,0 mm		Ø 2,4/3,0/3,2/4,0/4,8/5,0 mm
	Ø 2,4/3,0/3,2/4,0/4,8/5,0 mm		Ø 2,4/3,0/3,2/4,0/4,8/5,0 mm

Ref.	Ø [mm]	L [mm]	⊠	EAN
18-103	2,4/3,2/4,0/4,8	265	10/30	5907558405811

**NEO**  
TOOLS

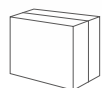

	Ø 2,4/3,0/3,2/4,0/4,8/5,0/6,0/6,4 mm		Ø 2,4/3,0/3,2/4,0/4,8/5,0/6,0/6,4 mm
	Ø 2,4/3,0/3,2/4,0/4,8/5,0/6,0/6,4 mm		Ø 2,4/3,0/3,2/4,0/4,8/5,0/6,0/6,4 mm

Ref.	Ø [mm]	L [mm]	m [kg]	⊠	EAN
18-106	3,2/4,0/4,8/6,0/6,4	480	1,95	0/10	5907558412246



# Nitownica

Riveter / Nietmaschine / Заклепочник / Клепальный инструмент / Popszegecszűz / Mašina de nituit / Nýtovačka / Kliešte nitovacie ocelové / Pištola za kovičenje / Kniediklis / Kniežu stangas / Needitangid/ Нитачка / Klijesta za zakovice / Pistolj za pop nitne / Нлџ / Remachadora / Rivettatrice / Rebitadora / Riveuse / Klinknagelmachine

**NEO**  
TOOLS



**NEO**  
TOOLS



Ø 2,4/3,0/3,2 mm



Ø 2,4/3,0/3,2/4,0/4,8/5,0 mm



Ø 2,4/3,0/3,2 mm



Ø 2,4 mm

Ref.	Ø [mm]	L [mm]	⊠	EAN
18-102	2,4/3,2/4,0/4,8	280	10/20	5907558400144



Ø 2,4/3,0/3,2/4,0/4,8 mm



Ø 2,4/3,0/3,2/4,0/4,8 mm



Ø 2,4/3,0/3,2/4,0/4,8 mm



Ø 2,4/3,0/3,2/4,0/4,8 mm

Ref.	Ø [mm]	L [mm]	m [kg]	⊠	EAN
18-107	2,4/3,2/4,0/4,8	275	0,75	6/24	5907558413564

**T TOPEX**



Ref.	L [mm]	⊠	EAN
43E707	250	10/40	5902062020666

**T TOPEX**



Ref.	L [mm]	⊠	EAN
43E701	260	0/24	5902062020079

**T TOPEX**



Ref.	L [mm]	⊠	EAN
43E712	270	0/24	5902062020260

**T TOPEX**

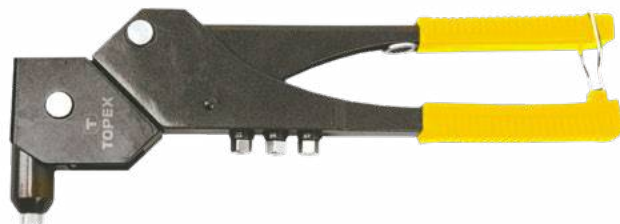

Ref.	L [mm]	⊠	EAN
43E713	300	0/24	5902062020246

**T TOPEX**



Ref.	L [mm]	m [kg]	⊠	EAN
43E780	535	1,3	0/10	5902062020130

**TOP TOOLS**



Ref.	Ø [mm]	L [mm]	⊠	EAN
43E703	2,4; 3,2; 4,0; 4,8	249	0/24	5902062020239



## Nity

Rivets / Nieten / Закленки / Кленки / Popszegecs / Şuruburi / Nýty / Nit hliníkový trhací / Kovice / Kniedés / Kniedes / Needid / Humose / Zakovice / Pop nitne / Ηλοι / Remaches / Rivetti / Rebites / Rivets / Klinknagels

**TOPEX**

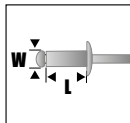

ALUMINIUM

Ref.	WxL [mm]	N				EAN
43E301	3,2 x 8	x50	x			0/400 5902062020154
43E302	3,2 x 10	x50	x			0/400 5902062020192
43E401	4,0 x 8	x50	x			0/200 5902062020161
43E402	4,0 x 10	x50	x			0/200 5902062020949
43E421	4,0 x 10	x800	x	x		0/20 5902062020987
43E403	4,0 x 12,5	x50	x			0/150 5902062020208
43E404	4,0 x 16	x50	x			0/150 5902062020284
43E405	4,0 x 18	x50	x			0/150 5902062020291
43E501	4,8 x 8	x50	x			0/150 5902062020178
43E502	4,8 x 10	x50	x			0/120 5902062020215
43E503	4,8 x 12,5	x50	x			0/120 5902062020956
43E504	4,8 x 14,5	x50	x			0/120 5902062020222
43E505	4,8 x 18	x50	x			0/100 5902062020307
43E507	4,8 x 23	x50	x			0/100 5902062020314
43E509	4,8 x 28	x50	x			0/90 5902062020321

## Nitownica do kołków rozporowych

Riveter for expansion pins / Nietpresse für Spreizdübel / Заклепочник для распорных дюбелей / Заклепочник / Tiplizőfogó / Presă de nituit / Nýtovačka pro rozprácní kolíky / Nitovačka na rozpretné nity / Kovičnik za zakrivanje klinov / Profiliju kniediklis / Pretbidna kniedētājs / Löötsaga needitangid / Нитовачка за распорни болтове / Alat za zakivanje tipli / Mašina za zakivanje klinova / Πριταναδόρος για κωνικές σπήνες / Remachadora para pasadores de espiga / Rivettatrice / Rebitadora para pinos / Riveuse pour chevilles expansibles / Klinknagelmachine voor uitzetpenen

**TOPEX**

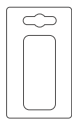

Ref.	L [mm]		EAN
43E790	255	12/36	5902062427908

4,0  
Ø [mm]

5,0  
Ø [mm]

6,0  
Ø [mm]

**TOPEX**

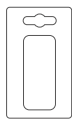

Ref.	L [mm]		EAN
43E791	170	12/24	5902062427915

3,0  
Ø [mm]

4,0  
Ø [mm]

5,0  
Ø [mm]

6,0  
Ø [mm]

## Nitownica na nitonakrętki

Nut riveter / Nietmaschine für Nietmuttern / Заклепочник для заклепочных гаек / Клепальный инструмент для мутр / Popszegecs húzó anyaszzegecs húzó / Maşină de nituit piuliţă / Nýtovačka nýtových šroubů / Kliešte nitovacie / Pištola za kovičenje / Kniediklis besisukantis / Kniežu stangas / Neetmutritangid / Ημπαύκη / Nitne zakovice / Pistolj za pop nitne / Πριταναδόρος για πριταίνα / Remachadora para remaches de rosca / Rivettatrice / Rebitadora p. Rebites e porcas / Riveuse à rivets à jaquette / Klinknagelmachine voor moer klinknagels

**TOPEX**

AL  
M3/M4/M5/  
M6/M8



Ref.		EAN
43E111	0/18	5902062064172

## Nitonakrętki

Nut rivets / Nietmuttern / Γαίηκι заклепочные / Кленки мутрови / Anyaszzegecs / Maşină de nituit piuliţă / Nýtové šrouby / Nitové matice / Kovice / Kniedés veržles / Kniežu stangas / Neetmutrid / Ημπαύκη / Nitne zakovice / Pistolj za pop nitne / Πριταίνα / Remache de rosca / Rivetti / Rebites e porcas / Rivets à jaquette / Moer klinknagel

**TOPEX**

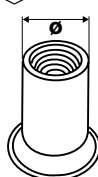

x20

ALUMINIUM

Ref.	Typ	Ø [mm]		EAN
43E133	M3	4,9	20/200	5902062064134
43E134	M4	5,9	20/200	5902062064141
43E135	M5	6,9	20/200	5902062064158
43E136	M6	8,9	20/200	5902062064165

## Szczypce do łączenia profili

Metal stud crimping tool / Profilverbindingsszange / Заклепочник прошивной для профилей / Клепальный инструмент / Peremezőfogó / Deşte p/u profiluri cu pereţi subţiri / Kliešte na spojování profilů / Kliešte nitovacie pre sadrokartónové profily / Klieše za spajanje profilov / Replés profíliams jungti / Stangas metala profíliem / Painutusnäpitsad poltidele / Ημπαύκη / Klijesta za zakovice / Klesta za zakivanje / Πένσα για συνένωση προφίλ / Tenazas para juntar perfíles / Utensile per perni metallici periferici / Pinças p. Juntar perfis / Pince à connecter des profilés / Tang voor profielen

**TOPEX**

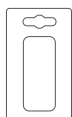

Ref.	L [mm]		EAN
43E100	350	5/20	5902062430007

**TOPEX**

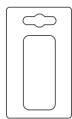

Ref.	L [mm]		EAN
43E101	260	6/24	5902062430014





## Szczypce do nitów

Eyelet pliers / Nietzange / Заклепочник / Щипци клепаљни / Szegecselőfogó szeg / Clește pentru capse / Nýtovací kleště / Kliešte na nity / Klešče za zakovice / Replės kniediklės / Kniedētājs / Needitangid / Клеуци за нитове / Kliješta za zakovice / Klešta za nitne / Πρισταναβόρος / Alicates para remaches / Pinza occhiellatrice / Pinças p. Rebites / Pince à rivets / Klingnagelstang



x100

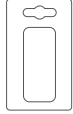

Ref.	L [mm]	☒	EAN
32D422	165	5/50	5902062010711

## Nity

Rivets / Nieten / Закленки / Кленки / Szegecs fogóhoz / Şuruburi / Nýty / Nit hliníkový trhací / Kovice / Kniedės / Kniedės / Needid / Humoos / Zakovice / Pop nitne / Ηλοι / Remaches / Occhielli / Rebites / Rivets / Klingnagels



x200

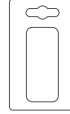

Ref.	info	☒	EAN
32D420	for 32D422	20/400	5902062324207

## Zestaw do lutowania

Soldering kit / LötKolben-Set / Набор для пайки / Набор до лютування / Forrasztófej / Garnitură de lipit cu aliaje / Sada pro pájení / Spájkovacia súprava / Komplet za spajkanje / Kompletas litavimui / Lodēšanas komplekts / Jootmiskomplekt / Комплект за запояване / Set za lemjenje / Pribor za lemjenje / Σετ συγκόλλησης / Equipo para soldar / Cannello / Kit p. Soldagem / Jeu de brasage / Soldeerset



2 kW  
1850 °C  
140 g/h  
1.5m



Ref.	P [kW]	☒	EAN
20-011	2	0/10	5907558455106



3-6 kW  
1850 °C  
210-430 g/h  
1.5m



Ref.	P [kW]	☒	EAN
20-012	3 - 6	0/10	5907558455113

## TOPEX



1.5m

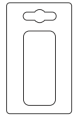

Ref.	T [°C]	q [g/h]	P [kW]	☒	EAN
44E110	1850	140	2	0/10	5902062441102

## TOPEX



1.5m

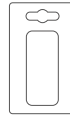

Ref.	T [°C]	q [g/h]	P [kW]	☒	EAN
44E111	1850	140	2	0/10	5902062441119

## Zestaw palników

Burners set / Brenner-Set / Набор зажигателей / Набор пальників / Forrasztó készlet / Set de suflaie / Sada hořáků / Súprava horákov / Komplet vžgalnikov / Deglikių kompleksas / Degļu komplekts / Pāletikomplekt / Комплект от горелки / Set grijača / Komplet gorionika / Σετ αναφλεκτήρων / Juego de sopletes / Kit per bruciatore a gas / Kit de Maçaricos / Jeu de chalumeaux / Set van branders

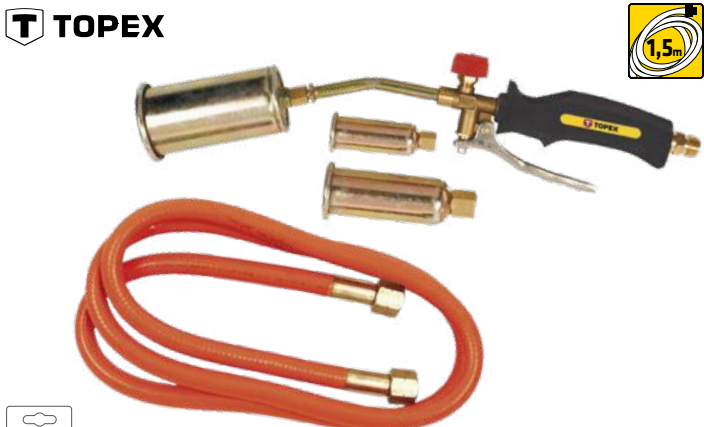

1.5m

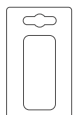

Ref.	T [°C]	q [g/h]	P [kW]	☒ [kg]	☒	EAN
44E115	1850	2000	19,5	0,9	0/6	5902062441157

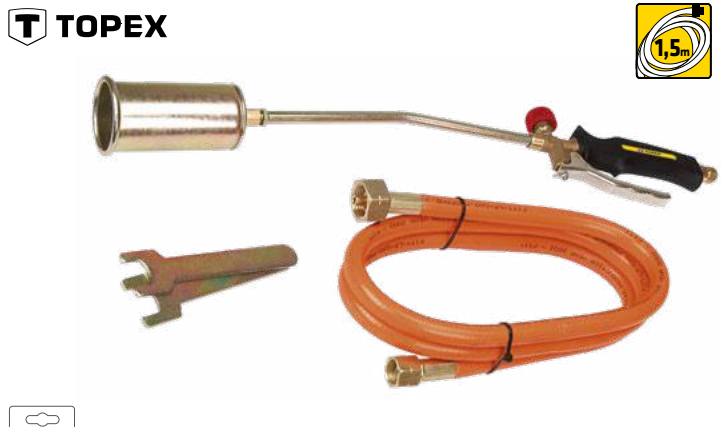

1.5m

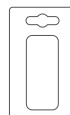

Ref.	T [°C]	q [g/h]	P [kW]	☒ [kg]	☒	EAN
44E120	1400	2000	28	1,1	0/10	5902062441201



## Zestaw palników

Burners set / Brenner-Set / Набор зажигателей / Набор паяльников / Forrasztó készlet / Set de suflaie / Sada hořáků / Súpava horákov / Komplet vžigalnikov / Degikliü kompletas / Deglu kompleks / Páletikomplekt / Комплект от горелки / Set grijača / Komplet gorionika / Σετ αναφλεκτήρων / Juego de sopletes / Kit per bruciatore a gas / Kit de Maçaricos / Jeu de chalumeaux / Set van branders

**TOPEX**



Ref.	T [°C]	q [g/h]	P [kW]	kg [kg]	kg [kg]	EAN
44E117	1850	max 2000	28	5,6	0/3	5902062441171

## Lutownica gazowa

Soldering torch / GaslötKolben / Газовый паяльник / Лютувальник газовий / Forrasztó készlet / Ciocan de lipit, cu gaz / Plynová páječka / Plynová spájkováčka / Plinski spajkalnik / Dujinis lituoklis / Gázes lodāmurs / Gaasjoetekolb / Газов паяльник / Plinska lemilica / Gasna lemilica / Καυνέτο / Soldadura a gas / Soldatore a gas / Soldador de gás / Fer à souder à gaz / Gassoldeerbout

**TOPEX**

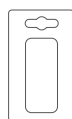

Ref.	T [°C]	q [g/h]	P [kW]	kg [kg]	kg [kg]	EAN
44E118	1850	140	2	1,1	0/6	5902062441188

## Zestaw dekarski

Roofwork kit / Dachdecker-Set / Набор кровельщика / Набор дахарський / Forrasztó készlet / Set de țiglărie / Pokrývačská sada / Pokrývačská súprava / Komplet za krovce / Kompletas stogdengiui / Jumika kompleks / Katusepanijakomplekt / Покривачески комплект / Krovopokrivači set / Krovni komplet / Σετ στεγαστή / Juego de herramientas de techador / Accessorio per coperture / Kit especial / Jeu d'outils de couvreur / Dakwerkset

**TOPEX**

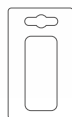
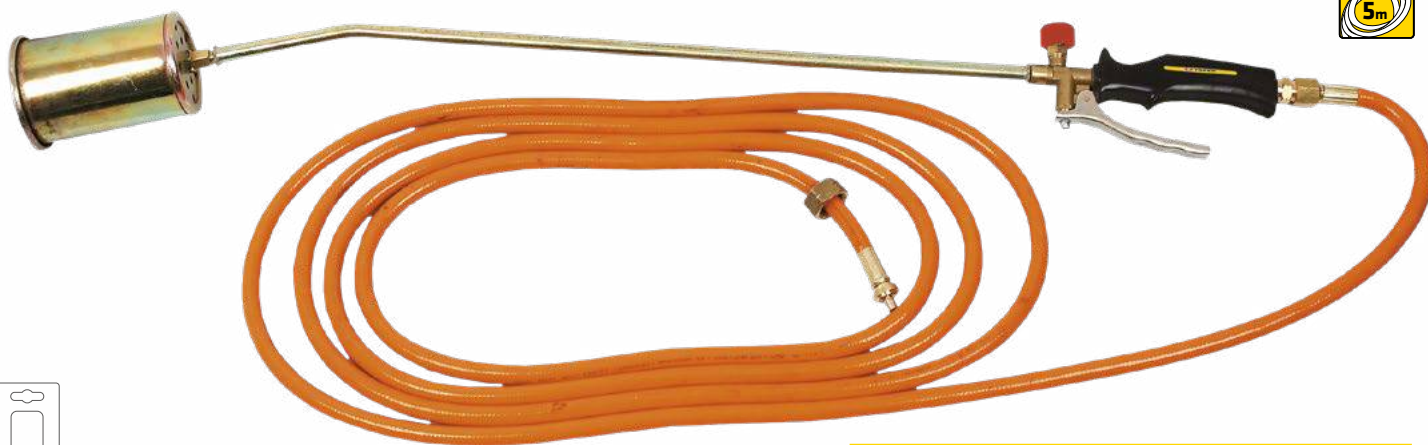

Ref.	T [°C]	q [g/h]	P [kW]	kg [kg]	kg [kg]	EAN
44E122	1850	4000	58	1,5	0/6	5902062441225

**TOPEX**

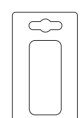
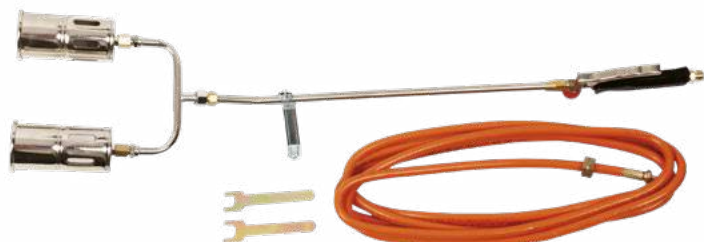

Ref.	T [°C]	q [g/h]	P [kW]	kg [kg]	kg [kg]	EAN
44E121	1850	7800	110	1,5	0/6	5902062441218

**TOPEX**

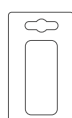

Ref.	T [°C]	q [g/h]	P [kW]	kg [kg]	kg [kg]	EAN
44E123	1850	6900	99	1,8	0/6	5902062441232



## Reduktor ciśnieniowy

Pressure reducer / Druckminderer / Редуктор давления / Редуктор тиску / Nyomásszabályzó / Reductor de presiune / Tlakový reduktor / Tlakový reduktor / Tlačni reduktor / Sleginis reduktorius / Spiediena reduktors / Röhreduktor / Редуктор на налягането / Reduktor pritiska / Reduktor pritiska / Μεωτήρας πίεσης / Reductor de presión / Riduttore di pressione / Redutor de tensão / Réducteur de pression / Drukreductiestuk

**NEO**  
TOOLS



Ref.	☒	EAN
20-130	0/6	5907558460247

## Redukcja do butli

Reduction for cylinder / Reduzierstück für Flasche / Редуктор для бутылки / Редуктор на балон / Hollandi gáspalackhoz / Reducție la butelie / Reducție na láhve / Adaptér na kartuše / Ventil za jeklenko / Dujų baliono reduktorius / Reduktors / Balloinireduktor / Редукция за бутылката / Redukcija za bocu / Smanjenje za cilindar / Μεωτήρας για बोξίο / Adaptador para botella / Adattatore / Redução p. Garrações / Réduction pour bouteille / Reductiestuk voor flessen

**T TOPEX**



Ref.	☒	EAN
44E139	0/50	5902062441393

## Wąż przyłączeniowy do gazu

Gas connecting hose / Gasumschalt Schlauch / Шланг газоподводящий / Шланг газовой / Gáztöltő hosszabító / Furtun de racord, pentru alimentare gaz / Připojná hadice na plyn / Připojná hadica na plyn / Priključna cev za plin / Prijungimo vamzdis, dujoms / Gāzes pievadšūtene / Gaasiühendusvoolik / Газопроводен маркуч / Priključno crijevo za plin / Priključno crevo za gas / Εύκαμτος σωλήνας παροχής αερίου / Manguera de conexión para gas / Tubo di connessione per gas / Mangueira de ligação p. Gás / Тувау flexible de raccordement à gaz / Verbindungslang voor gas

**NEO**  
TOOLS

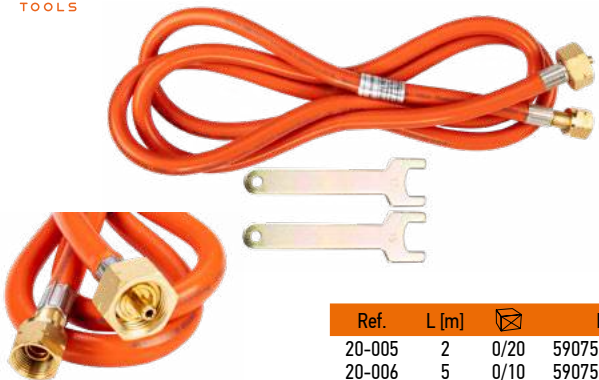

Ref.	L [m]	☒	EAN
20-005	2	0/20	5907558455083
20-006	5	0/10	5907558455090



## Lampa lutownicza

Liquid gas blow-lamp / Lötlampe / Лампа паяльная / Газ рідкий для лампи паяльної / Forrasztókészülék / Lampă sudat cu gaz lichid / Pájeci lamp / Pájkováčka plynová / Plinski gorilnik / Litavimo lempa / Lodalampa / Jootelamp (vedelgaas) / Лампа газова / Plinska lemilica / Gasna lemilica / Καυμένο υγραερίου / Lámpara de soldar a gas / Lampada per saldare / Lâmpada p. Soldar / Lampe à braser / Soldeerlamp

**NEO**  
TOOLS



Ref.	T [°C]	q [g/h]	P [kW]	☒	EAN
20-021	1350	87	1.2	0/12	5907558455151

**NEO**  
TOOLS



Ref.	info	T [°C]	q [g/h]	P [kW]	☒	EAN
20-022		1350	87	1.2	0/12	5907558455168
20-045	+ 4 x 20-033	1350	87	1.2	0/12	5907558488265

**T TOPEX**



44E141

44E143

Ref.	T [°C]	q [g/h]	P [kW]	☒	EAN
44E141	1350	180	1,9	0/14	5902062441430
44E143	1350	180	1,9	0/14	5902062021021

**T TOPEX**



Ref.	info	T [°C]	q [g/h]	P [kW]	☒	EAN
44E142	-	1350	180	1,9	0/14	5902062441416
44E148	+ 6 x 44E150	1350	180	1,9	0/8	5902062019257
44E154	+ 4 x 44E150	1350	180	1,9	0/10	5902062070203



## Nabój z gazem butan

Butane gas cartridge / Butan-Gas-Patrone / Баллон с газом бутан / Балончики (картриджи) з газом бутан / Tartály gázlámpához / Cartuş cu gaz butan / Kartuşe s plynem butan / Butánová kartuša / Jeklenka s plinom butan / Butano dujy balionas / Balons ar butāna gāzi / Butaan-gaasipadrin / Бутилка с газ бутан / Patrona sa butan plinom / Patrona sa butan gasom / Δοχείο με μείγμα βουτανίου / Cartucho de gas butano / Bombola di gas / Cartuxo com gás / Cartouche avec gaz butane / Butaan vervangcartridge

**NEO**  
TOOLS



Ref.	m [g]	⊠	EAN
20-030	227	4/28	5907558449655



**Butan**

EN417:  
2012

**NEO**  
TOOLS



Ref.	m [g]	⊠	EAN
20-033	190	0/48	5907558468939



**Butan**

EN417:  
2012

**NEO**  
TOOLS



Ref.	m [g]	⊠	EAN
20-036	500	0/12	5907558468946



**Butan**

EN417:  
2012

**T TOPEX**



Ref.	⊠	EAN
44E150	0/48	5902062004772

**190 g GAS STOP EN417: 2012**

## Palnik gazowy

Gas burner / Gasbrenner / Горелка газовая / Пальник газовой / Forrasztófej / Arzator de gaz / Plynový hořák / Horák / Plinski gorilnik / Dujinis degiklis / Gāzes deglis / Gaasipōleti / Нагрыйник за горелка / Nastavak za plamenik / Gasna lemilica / Καυστήρας υπραερίου / Soplete / Beccuccio / Maçarico de gás / Chalumeau à gaz / Gasbrander

**NEO**  
TOOLS



**PIEZO**

nozzle type  
EN 417

**GAS**

**1.3 kW**

**1300 °C**

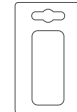

Ref.	info	T [°C]	P [kW]	⊠	EAN
20-025		1300	1.3	10/100	5907558449648
20-041	+ 20-030	1300	1.3	10/100	5907558486773
20-042	+ 2 x 20-030	1300	1.3	10/100	5907558465747

**NEO**  
TOOLS



**PIEZO**

nozzle type  
EN 417

**1.28 kW**

**1350 °C**

**GAS**

**AIR**

**SAFETY LOCK**

**360°**

Ref.	T [°C]	P [kW]	⊠	EAN
20-026	1350	1.28	10/60	5907558465365

## Mikropalnik

Microtorch / Mikrobrenner / Микрогорелка / Мініпальник / Forrasztókészülék piezos / Microinjector / Mikrohořák / Mikro rajkovačka / Gorilnik / Mikro degiklis / Lodlampa mini / Mikroleeklamp / Горелка микро / Mikro Plinska lemilica / Mikro gasna lemilica / Φλόγιστρο / Microsoplete / Micro bruciatore / Mikromaçarico / Micro-brûleur / Microbrander

**NEO**  
TOOLS



**1350°C**

**LIGHTER GAS**

**7,6g gas**

**PIEZO**

**26 min**

Ref.	⊠	EAN
19-904	0/40	5907558465716

**NEO**  
TOOLS



**1200°C**

**LIGHTER GAS**

**12,6g gas**

**PIEZO**

**38 min**

Ref.	⊠	EAN
19-905	0/40	5907558465723



## Mikropalnik

Microtorch / Mikrobrenner / Микрогорелка / Мініпаяльнік / Forrasztókészülék piezo / Microinjector / Mikrohořák / Mikro rajkovačka / Gorilnik / Mikro degiklis / Lodlampa mini / Mikroleeklamp / Горелка микро / Mikro Plinska lemilica / Mikro gasna lemilica / Φλόγιστρο / Microsoplete / Micro bruciatore / Mikromaçarico / Micro-brûleur / Microbrander

**NEO**  
TOOLS



Ref. EAN  
19-906 50/200 5907558465730

**T TOPEX**



Ref. T [°C] V [ml] EAN  
44E108 200-400 12 0/20 5902062441089

## Stacja lutownicza

Soldering station / Lötstation / Паяльная станция / Паяльна станция / Forrasztóállomás / Stație de lipit / Pájeci stanice / Spájkovacia stanica / Spajkalna postaja / Litavimo stotis / Lodēšanas stacija / Jootejaam / Станция за запояване / Postaja lemilice / Stanica lemilice / Σταθμός κόλλησης / Estación de soldadura / Stazione di saldatura / Estação de solda / Poste de soudure / Soldeerstation

**NEO**  
TOOLS



**NEO**  
TOOLS



Ref. EAN  
19-220 0/80 5907558468915

## Końcówki do lutownicy

Soldering tips / Lötspitzen / Наконечники для паяльника / Наконечники до лютувальника / Forrasztóhegyek / Capete pentru ciocan de lipit / Koncovky pro páječku / Nástavec spájkovačky / Konice za spajkalnik / Antgaliai lituokliui / Lodēšanas uzgaļi / Jootekolbi otsakud / Накраїниці за паяльника / Vrhovi za lemilicu / Nastavci za lemljenje / Μύτες κολλητηρίου / Boquillas para soldar / Inserti per saldatore / Ponteiros p. soldador / Embouts de fer à souder / Soldeereindstukken

**NEO**  
TOOLS



Ref. EAN  
19-225 0/500 5907558468922

## Lutownica oporowa

Soldering iron / WiderstandslötKolben / Паяльник контактный / Паяльнич / Forrasztórak / Ciocan de lipit / Odporová páječka / Pájkovačka hrotová odporová / Spajkalnik / Lituoklis / Lodāmsurs / Jootekolb / Паялник / Električna lemilica / Pistolj lemilica / Εμβόλο συγκολλησεων / Soldador / Saldatore elettrico / Soldador por resistència / Fer à souder à résistance / Weerstand soldeerbout

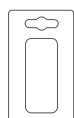
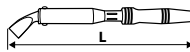
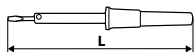

Ref. P [W] L [mm] EAN  
44E024 40 217 10/50 5902062172327  
44E026 60 237 10/50 5902062172334  
44E029 100 273 25/50 5902062020574

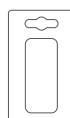

Ref. P [W] L [mm] EAN  
44E030 150 350 10/20 5902062440303  
44E031 200 355 10/20 5902062440310



## Lutownica transformatorowa

Soldering gun / Trafo-Lötkolben / Паяльник трансформаторный / Паяльный пистолет / Forrasztópisztoly / Ciocan de lipit / Pájecí stanice s transformátorem / Pájkováčka elektronická / Spajkalnik / Transformatorinis lituoklis / Lodāturis ar transformātoru / Jootepestol / Паяник / Pistólj lemilica / Pistólj lemilica / Ηλεκτρικό κολλητήρι με μετασχηματιστή / Pistola para soldar / Pistola per saldatura / Soldador por transformador / Fer à souder redresseur / Transformator soldeerbout

**NEO**  
TOOLS



Ref. 19-152 | EAN 5907558472059

**TOPEX**



Ref. 44E002 | P [W] 100 | EAN 5902062021045

**NEO**  
TOOLS



Ref. 19-151 | EAN 5907558464696

**TOPEX**



Ref. 44E005 | P [W] 150 | [kg] 1,5 | EAN 5902062671509

**NEO**  
TOOLS



Ref. 19-153 | EAN 5907558472066

**TOP TOOLS**



Ref. 44E000 | P [W] 100 | EAN 5902062020550

## Końcówki do lutownicy transformatorowej

Tips for soldering gun / Trafo-Lötkolbenendstücke / Наконечники на паяльник трансформаторный / Наконечники для паяльного пистолету / Pákcacsúcs / Canule ciocan de lipit / Koncovky do páječky s transf. / Hroty náhradné / Nastavki za spajkalnik / Transformatorinio lituoklio antgaliai / Uzgali lodāturam ar transformātoru / Jootepestoli otsikud / Накрайник за паяник / Nastavci za pistolj lemilicu / Nastavci za pistolj lemilicu / Μύτες ηλεκτρικού κολλητηριού με μετασχηματιστή / Puntas para pistola de soldar / Punte per pistola saldatrice / Punteiros p. soldador / Embouts de fer à souder redresseur / Eindstuk voor transformator solderen

**TOPEX**

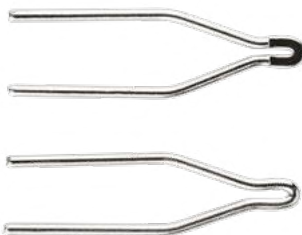

Ref.	info	N	⊠	EAN
44E004	for 44E005	3	0/1000	5902062440044
44E007	for 44E002	2	25/100	5902062440075

**TOP TOOLS**



Ref.	info	⊠	EAN
44E003	for 44E000	100/600	5902062020963



## Odsysacz cyny

Desoldering pump / Zinn-Absauger / Пистолет для снятия припоя / Циновідсмоктувач / Ónszívó / Dispozitiv de aspirarea cositorului / Odsavač cínu / Odsávač cínu / Odstranjevalec cina / Alavo siurblys / Lodalvas atsikrėnėjis / Tinaimur / Καλανα помпа / Sisaljka za kositar / Usisivač za kalaj / Αντλία αφαίρεσης κόλληρας / Dispositivo de aspiración de estaño / Pompa dissaldante / Máquina de remover estanho / Pompe à braser à l'étain / Tinafzuiger



**TOPEX**



Ref.	L [mm]	☒	EAN
44E006	190	100/200	5902062440068

## Spoiwo lutownicze

Solder wire / Lötlegierung / Присодочный паяльный материал / Люта / Forrasztóórn / Liant / Pojivo pro rájení / Spájka / Spajkalna žica / Litavimo medžiaga / Lodēšanas saistviela / Jootetäide / Припой / Spojinka za lemjenje / Vezivo za lemjenje / Kalái / Metal de aportación para soldadura / Filo per saldare / Solda / Liant de brasure / Soldeernaald

**TOPEX**



Ref.	Sn %	Ø [mm]	m [g]	topnik	☒	EAN
44E512	60	0,7	100	SW 26	0/190	5902062020680
44E514	60	1,0	100	SW 26	0/144	5902062020703
44E522	60	1,0	100	SW 26B	0/144	5902062020741
44E524	60	1,5	100	SW 26B	0/144	5902062020765
44E532	60	1,5	100	SW 21	0/144	5902062020789

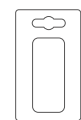

## Lut cynowy

Tin solder / Lötzin / Припой оловянный / Люта цинова / Forrasztóórn / Alij de lipit din cositor / Cínová rájka / Cín spajkovač / Tinol žica / Aliuminio lydmetalis / Lodalva / Tinajoodis / Тинол / Tinol žica / Tinol zica / Καλαί / Soldadura de estaño / Lega per saldatura di stagno / Solda / Soudure d'étain / Zink soldeernaald

**Cynel**  
unipress

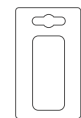

Ref.	Sn %	Cu %	Ø [mm]	m [g]	☒	EAN
44E742	97	3	2,5	100	0/180	5902062020802

**Cynel**  
unipress

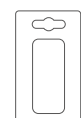

Ref.	Sn %	Ø [mm]	L [mm]	N	☒	EAN
44E517	60	7 x 7	250	1	0/210	5902062994974
44E519	60	7 x 7	250	3	0/70	5902062020727

## Kalafonia

Calophony / Kolophonium / Канифоль / Канифоль / Forrasztó gyanta / Colofoni (sacáz) / Kalafuna / Kolofónia / Kolofojnja / Kanifolija / Kolofojnjs / Vaik / Колофон / Kalafonija / Kolofojnium / Κολοφωνία πίσσα / Colofonia / Colofonia / Colophane / Colophonium

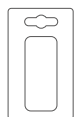

Ref.	m [mL/g]	☒	EAN
44E812	35	0/180	5902062020826

## Topnik

Paste flux / Flussmittel / Флюс / Паста-припой / Folyósítószér / Flux pastă / Tavnici přísady / Pasta na rájkovanie / Tinol žica / Litavimo pasta flusas / Lodpasta / Jootepasta / Паста за запояване / Tinol pasta / Tinol zica / Πάστα συγκόλλησης / Fundente: pasta / Fondente / Fundente / Décarpant / Flux

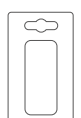

Ref.	m [mL/g]	☒	EAN
44E816	35	0/180	5902062020840

## Zestaw do lutowania

Soldering kit / LötKolben-Set / Набор для пайки / Набор до лютування / Forrasztószett / Garnitură de lipit cu aliaje / Sada pro rájení / Spájkovacia súprava / Komplet za spajkanje / Kompletas litavimui / Lodēšanas komplekts / Jootmiskomplekt / Комплект за запояване / Set za lemjenje / Pribor za lemjenje / Σετ συγκόλλησης / Equipo para solda / Completo per saldatura / Kit p. Soldagem / Jeu de brasage / Soldeerset

**Cynel**  
unipress

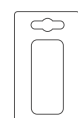

Ref.	☒	EAN
44E745	lut cynowy 97% Sn, 3% Cu, Ø 2,5mm, 100g + topnik 100g	0/120 5902062209436
44E731	lut cynowy 60% Sn, Ø 1,5mm, SW21, 100g + kalafonia 35ml	0/120 5902062209412

## Opaski zaciskowe

Band clips / Klemmschellen / Хомутки стяжные / Хомутки стяжні / Kábelkötégelő / Cleme conexiune / Hadicové pásky / Fixačné pásky / PVC vezice / Užspauđejas / Savilcēji / Rihmaklamber / PVC vezice / Κολλάρια αούφιξης / Fascette per cavi / Cintas p. gramppear / Bride de serrage / Klemmbanden

**NEO**  
TOOLS



Ref.	color	W [mm]	L [mm]	N	☒	EAN
01-600	■	2.5	100	100	0/250	5907558468007
01-601	□	2.5	200	100	0/250	5907558468014
01-602	■	2.5	200	100	0/250	5907558468021
01-603	■	3.6	300	100	0/125	5907558468038
01-604	□	3.6	300	100	0/125	5907558468045
01-605	□	2.5	100	100	0/250	5907558468052
01-606	■	3.6	200	100	0/200	5907558468069
01-607	□	4.8	200	75	0/200	5907558468076
01-608	■	4.8	200	75	0/200	5907558468083
01-609	□	4.8	300	75	0/150	5907558468090
01-610	■	4.8	300	75	0/150	5907558468106
01-611	□	4.8	370	75	0/100	5907558468113
01-612	■	4.8	370	75	0/100	5907558468120
01-613	■	7.6	500	75	0/50	5907558468137
01-614	□	7.6	500	75	0/50	5907558468144

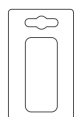

**TOP TOOLS**



Ref.	color	W [mm]	L [mm]	N	☒	EAN
44E956	■	2,5	100	x100	0/500	5902062449566
44E958	■	2,5	200	x100	0/400	5902062449580
44E960	■	3,6	300	x100	0/100	5902062449603
44E950	□	2,5	100	x100	0/500	5902062449504
44E952	□	2,5	200	x100	0/400	5902062449528
44E954	□	3,6	300	x100	0/125	5902062449542

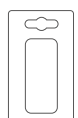



**ДЕКОРАТОРСКІЕ**  
DECORATING ОЗДОБЛЮВАННЯ





## Nóż z ostrzem łamanym

Snap-off blade knife / Messer m. gebrochener Klinge / Нож с отламывающимся лезвием / Ніж з ламаним лезом / Törhető pengés kés / Čužit lamě demontabilá / Nůž se zalomeným ostrím / Nožik lámací / Nož / Peilis su nulaužiamą geležte / Tapešu nazis / Kokkukäiva teraga nuga / Макетен нож / Skalpel / Skalpel / Koniči «snap Off» / Cúter / Taglierino con lama scorrevole / Faca com lâmina curvada / Couteau à lame cassable / Met met gebroken lemmet

**NEO**  
TOOLS

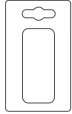

Ref.	W [mm]	📦	EAN
63-012	25	12/72	5907558443530

**NEO**  
TOOLS

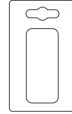

Ref.	W [mm]	📦	EAN
63-050	18	12/72	5907558420760

**NEO**  
TOOLS

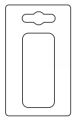

Ref.	W [mm]	📦	EAN
63-060	18	12/72	5907558420777

**NEO**  
TOOLS

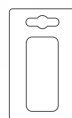

Ref.	W [mm]	📦	EAN
63-013	9	48/576	5907558484311

**NEO**  
TOOLS

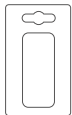

Ref.	W [mm]	📦	EAN
63-021	18	12/48	5907558410457

**NEO**  
TOOLS

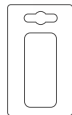

Ref.	W [mm]	📦	EAN
63-011	18	12/72	5907558410440

**NEO**  
TOOLS

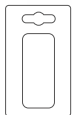

Ref.	W [mm]	📦	EAN
63-014	18	40/160	5907558484328

**TOPEX**

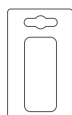

Ref.	W [mm]	D [mm]	📦	EAN
17B490	25	0,75	12/96	5902062141064

**TOPEX**

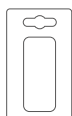

Ref.	N	W [mm]	D [mm]	📦	EAN
17B128	1	18	0,50	12/72	5902062140784
17B128Z	24	18	0,50	24/96	5902062997753

**TOPEX**

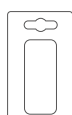
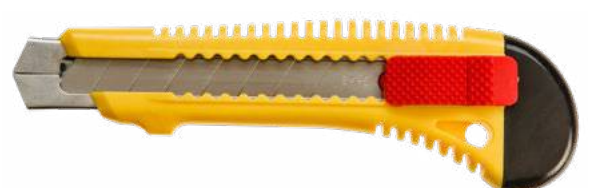

Ref.	W [mm]	D [mm]	📦	EAN
17B191	18	0,50	24/192	5902062009470



## Nóż z ostrzem łamanym

Snap-off blade knife / Messer m. gebrochener Klinge / Нож с отламывающимся лезвием / Ніж з ламаним лезом / Törhető pengés kés / Čužit lamä demontabilä / Nůž se zalomeným ostrím / Nožík lámací / Nož / Peilis su nulaužiama geležtė / Tapešu nazis / Kokkukäiva teraga nuga / Макетен нож / Skalpel / Skalpel / Копіт «snap Off» / Cúter / Taglierino con lama scorrevole / Faca com lâmina curvada / Couteau à lame cassable / Met met gebroken lemmet

**TOPEX**



Ref.	W [mm]	D [mm]	☒	EAN
17B168	18	0,50	12/144	5902062140883

**TOPEX**



Ref.	W [mm]	D [mm]	☒	EAN
17B103	18	0,50	12/72	5902062140975

**TOPEX**

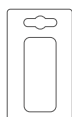

Ref.	W [mm]	D [mm]	☒	EAN
17B428	18	0,50	12/144	5902062140890

**TOP TOOLS**

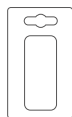

Ref.	W [mm]	☒	EAN
17B518	18	24/360	5902062140029

**TOP TOOLS**

**x3**

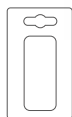

Ref.	N	☒	EAN
17B533	x3	24/288	5902062202017

**TOP TOOLS**



17B528



17B528-12

Ref.	W [mm]	N	☒	EAN
17B528	18	x1	50/200	5902062202789
17B528-12	18	x12	4/32	5902062196439

**TOP TOOLS**



Ref.	W [mm]	D [mm]	☒	EAN
17B328	18	0,50	25/150	5902062140524

**TOP TOOLS**

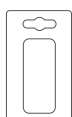

Ref.	☒	EAN
17B531	25/100	5902062002945



## Nóż z ostrzem trapezowym

Knife with utility blade / Messer mit Trapezklinge / Нож с трапециевидным лезвием / Нож з трапециевидним вістрям / Trapézpengés összecskukható kés / Cutter cu tăiş trapezoidal / Nůž s trapézovým ostrím / Nóż s trapézovou čepelou / Nož s trapézim rezilom / Peilis su trapezine geležte / Nazis ar trapezeida asmeni / Tragetsteraga nuga / Нож с трапецоидно острие / Nož s trapézastom ostricom / Nož sa trapézastom ostricom / Μαχαίρι με τραπεζοειδή ακμή / Cúter con hoja trapezoidal / Taglierino a lama fissa / Faca com Lâminas de trapézio / Couteau à lame trapézoïdale / Trapezium mes

NEO  
TOOLS



Ref.	⊠	EAN
63-700	6/48	5907558483932

NEO  
TOOLS



Ref.	W [mm]	⊠	EAN
63-702	18	0/80	5907558400212

## T TOPEX



Ref.	W [mm]	D [mm]	⊠	EAN
17B172	170	0,65	8/32	5902062140982

## T TOPEX



Ref.	W [mm]	D [mm]	⊠	EAN
17B160	175	0,65	6/36	5902062140913

## Nóż monterski

Fitter's knife / Monteurmesser / Нож монтерский / Нож монтерський / Bicska / Cutit pentru cabluri / Nůž montérský / Montérský nož / Montažni nož / Montuotojo peilis / Montiera nazis / Elektrikunuga / Монтаорски нож / Monterski nož / Monterski nož / Μαχαίρι ηλεκτρολόγου / Cuchillo recto para cables / Coltello a serramanico / Faca p. montagem / Couteau de monteur / Montagemes

NEO  
TOOLS



Ref.	L [mm]	⊠	EAN
63-015	180	30/300	5907558484335

## T TOPEX



Ref.	W [mm]	D [mm]	⊠	EAN
17B140	155	0,65	10/100	5902062140593

NEO  
TOOLS



Ref.	L [mm]	⊠	EAN
63-017	170	25/250	5907558484359

## Nóż uniwersalny

Knife / Universalmesser / Нож универсальный / Нож / Trapézpengés összecskukható kés / Cutit / Univerzální nůž / Nóż univerzálny / Nož / Universalus peilis / Nazis / Nuga / Ножче / Džepni nožić / Nož / Μαχαίρι γενικής χρήσης / Cuchillo universal / Taglierino a lama fissa / Faca universal / Couteau universel / Universele mes

NEO  
TOOLS

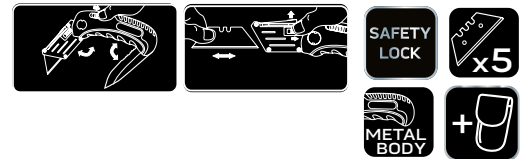

Ref.	⊠	EAN
63-710	6/48	5907558420791



## Nóż uniwersalny

Knife / Universalmesser / Нож универсальный / Нож / Bicska / Cutit / Univerzální nůž / Nóż uniweryalny / Nož / Universalus peilis / Nazis / Nuga / Ножиче / Džepni Nožić / Noz / Μαχαίρι γενικής χρήσης / Cuchillo universal / Coltello a serramanico / Faca universal / Couteau universel / Universele mes

**T TOPEX**

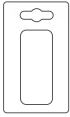

Ref.	L [mm]	⊠	EAN
98Z007	80	12/120	5902062140869

**T TOPEX**

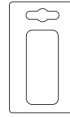

Ref.	L [mm]	⊠	EAN
98Z017	75	12/72	5902062140654

**T TOPEX**

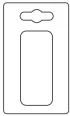

Ref.	L [mm]	⊠	EAN
98Z103	120	10/50	5902062981035

**T TOPEX**

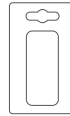

Ref.	L [mm]	⊠	EAN
98Z101	220	12/108	5902062981011

**T TOPEX**

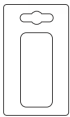

Ref.	L [mm]	⊠	EAN
98Z105	185	12/108	5902062981059

**T TOPEX**

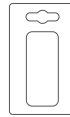

Ref.	L [mm]	⊠	EAN
98Z110	205	12/108	5902062981103

**T TOPEX**

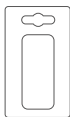
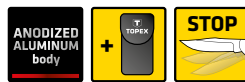

Ref.	L [mm]	⊠	EAN
98Z106	175	6/48	5902062012944

**T TOPEX**

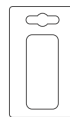

Ref.	L [mm]	⊠	EAN
98Z107	190	6/48	5902062012951



**TOP TOOLS**

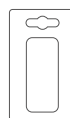

Ref.	L [mm]	⊠	EAN
98Z102	205	10/100	5902062981028



## Narzędzie wielofunkcyjne

Multipurpose tool / Allzweckwerkzeuge / Инструмент универсальный / Инструмент багатofункційний / Multiszerszám / Uneahta multifunctionala / Multifunkční nástroj / Viacfunkčné náradie / Večfunkcijsko orodje / Daugiafunkciniai įrankiai / Daudzfunkcionālie instrumenti / Multifunktsionaalne tööriist / Мультифункционален инструмент / Višenamjenski uređaj / Višefunkcionalne alatke / Πολυεργαλείο / Herramienta multiuso / Utensile multiuso / Aparelho multifunções / Outil multifonction / Multifunctioneel gereedschap

**TOPEX**



**9 in 1**

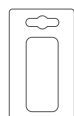

Ref.	⊠	EAN
98Z058	10/40	5902062012937

## Scyzoryk

Knife / Klappmesser / Нож перочинный / Нѳз / Zsebkés / cuřit / Kapesní nůž / Nůž / Nož / Peiliukas / Nazis / Nuga / Noz / Μαχαίρι γενικής χρήσης / Cortaplumas / Temperino / Canivete / Canif / Zakmes

**TOPEX**

**11 in 1**

STAINLESS STEEL

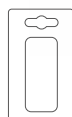

Ref.	⊠	EAN
98Z116	12/108	5902062981158

**TOP TOOLS**

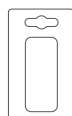
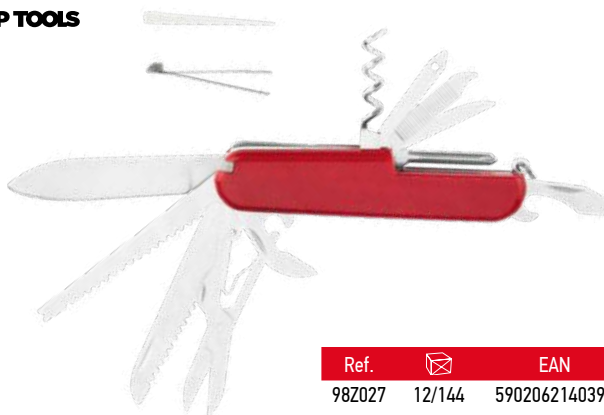

Ref.	⊠	EAN
98Z027	12/144	5902062140395

## Ostrza lamane

Snap off blades / Klängen, abbrechbar / Лезвия сменные отламывающиеся / Леза змінні, що обламуються / Törhető penge / Lame cutter / Odlamovací čepele / Odlamovacie čepele / Lomljiva rezila / Laužomi peiliukai / Maināmie nolaužāmie asmeņi / Vaibanoa terad / Отщипуващи се остриета / Lomljene oštrice / Lomljene oštrice / Αποσπώμενες κενίδες / Hojas segmentadas / Ricambio lame scorrevoli / Lāminas curvadas / Lames coupées / Gebogen bladen

**NEO TOOLS**

BLACK BLADE SK2 steel 25mm x10

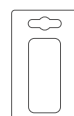

Ref.	L [mm]	⊠	EAN
64-012	9	10/120	5907558443547
64-013	18	10/120	5907558443554
64-014	25	10/120	5907558443561

**NEO TOOLS**

x10 18mm 0.5mm

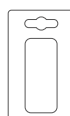

Ref.	W [mm]	⊠	EAN
64-010	18	10/300	5907558400229

**NEO TOOLS**

x10 TITANIUM blade PREMIUM 18mm 0.5mm

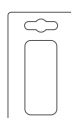

Ref.	W [mm]	⊠	EAN
64-020	18	10/300	5907558400236

**NEO TOOLS**

x10 9mm 0.4mm

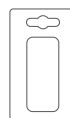

Ref.	W [mm]	⊠	EAN
64-210	9	10/300	5907558400243



## Ostrza lamane

Snap off blades / Klengen, abbrechbar / Лезвия сменные отламывающиеся / Леза змінні, що обламуються / Törhető penge / Lame cutter / Odlamovací čepele / Odlamovací čepele / Lomljiva rezila / Laužomi peiliukai / Maināmie nolaužamie asmeņi / Vaibanoa terad / Отчуждающ се остриета / Lomljene oštrice / Lomljene oštrice / Ανοσώμενες λεπίδες / Hojas segmentadas / Ricambio lame scorrevoli / Láminas curvadas / Lames coupées / Gebogen bladen

**NEO TOOLS** **x10** TITANIUM blade **0.4mm** **3-PHASE CUT** **64 HRC TITANIUM COATED**



Ref.	W [mm]	D [mm]	EAN
64-220	9	10/300	5907558400250

**TOPEX** **x10**



Ref.	W [mm]	D [mm]	EAN	
17B349	9	0,40	48/480	5902062140289
17B348	18	0,50	30/240	5902062140296

**TOPEX** **x5**



Ref.	W [mm]	D [mm]	EAN	
17B550	25	0,75	20/120	5902062141071

**TOP TOOLS** **x10**



Ref.	W [mm]	D [mm]	EAN	
17B548	18	0,50	20/240	5902062140494

## Ostrza trapezowe

Knife blades / Trapezklengen / Лезвия трапецеидальные / Леза ножови / Törhető penge / Cutt lamă / Lichoběžníkové ostří / Ostrie lichoběžníkové / Nadomestna rezila / Keičiamos geležtės / Naža asmeņi / Noaterad / Осмупе резервно / Nožiči za skalpel / Nozici za skalpel / Ανταλλακτικές λεπίδες / Hojas trapezoidales / Ricambio lame fisse / Láminas de trapézio / Tranchants trapézoïdaux / Trapezium mesbladen

**NEO TOOLS** **BLACK BLADE** **SK2 steel** **x10** **0.65mm**



Ref.	W [mm]	D [mm]	EAN
64-015		10/240	5907558443578

**NEO TOOLS** **x5** **0.65mm** **12mm**



Ref.	L [mm]	D [mm]	EAN
64-410	52	10/300	5907558400267

**NEO TOOLS** **x5** **0.65mm** **TITANIUM COATED**



Ref.	L [mm]	D [mm]	EAN
64-420	52	10/300	5907558400274

**TOPEX** **x5**



Ref.	L [mm]	D [mm]	EAN	
17B405	51	0,40	0/500	5902062140302

## Ostrza hakowe

Hook blades / Hackenklengen / Лезвия-крючки / Леза гаюки / Törhető penge / Lame secară pentru cutter / Háková čepele / Hákové čepele / Kľukasta rezila / Geležtē / Asmeņi-āķi / Konksterad / Остриета за куку / Kukaste oštrice / Kukasti noževi / Κοιλι τάντα / Hoja de gancho / Ricambio lame ad uncino / Láminas de anzol / Lames à crochets / Haakbladen

**NEO TOOLS** **x5** **0.6mm**



Ref.	EAN
64-610	10/300 5907558400281

**NEO TOOLS** **x5** **0.6mm** **TITANIUM COATED**



Ref.	EAN
64-620	10/300 5907558400298

**TOPEX** **x5**



Ref.	L [mm]	D [mm]	EAN	
17B2H5	51	0,65	60/600	5902062140739

## Gilotyna do paneli

Panel cutter / Guillotine für das Schneiden der Paneele / Панельный резак / Панельний різак / Lapvágó / Ghilotină pentru laminate / Rezačka panelů / Gilotina na rezanie panelov / Rezačka panelov / Skydo pjaustytuv / Paneļu griezējs / Paneelilõikur / Фреза за панел / Rezač ploča / Резач плоча / Κόφτης πάνελ / Taglierina per pannelli / Guilhotina para painéis / Guillotina para paneles / Coupe-panneau / Paneelsnijderas

**NEO TOOLS** **ALUMINUM BODY** **MAX WIDTH 210mm** **MAX THICKNESS 12mm** **HRC 49** **ZINC PLEATED** **HARDENED CARBON STEEL** **BI-MATERIAL HANDLE**



Ref.	L [mm]	EAN
56-010	210	0/4 5907558463705



# Maszynka do płytek ceramicznych

Tile cutting machine / Keramikfliesengerät / Плиткопес / Плиткоріз / Csempevágó / Aparat pentru taiat plăci ceramice / Řezací stroj na keramické obkládačky / Rezačka na keramické obkládačky / Stroj za keramične ploščice / Keramiinių plytelių pjaustyklė / Fižu zažigis / Plaidilõikur keraamilistele plaatidele / Машина за фаянсови плочки / Uredaj za keramičke pločice / Mašina za keramičke pločice / Κόπτης πλακιδίων / Cortador de azulejos / Macchina taglia piastrelle / Máquina para azulejos cerâmicos / Machine de coupe de carrelages céramiques / Tegelsnijder voor ceramiek

**NEO**  
TOOLS

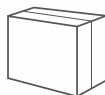

Ref.	L [mm]	☒	EAN
56-005	765	0/1	5907558408676

**T TOPEX**

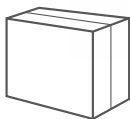

Ref.	L [mm]	W [mm]	☒	EAN
16B160	600	160	0/3	5902062220035

**T TOPEX**

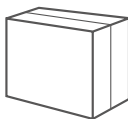

Ref.	L [mm]	W [mm]	☒	EAN
16B240	400	180	0/4	5902062091499
16B260	600	180	0/3	5902062091505

**T TOPEX**

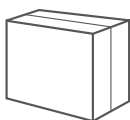
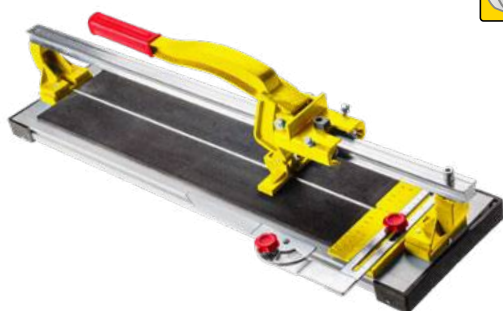

Ref.	L [mm]	☒	EAN
16B271	600	0/2	5902062092465
16B272	800	0/2	5902062092472
16B273	1000	0/2	5902062092489

**T TOPEX**

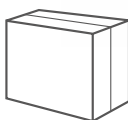

Ref.	L [mm]	☒	EAN
16B282	650	0/2	5902062000385

**TOP TOOLS**

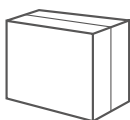

Ref.	L [mm]	W [mm]	☒	EAN
16B230	300	140	0/6	5902062091079

**TOP TOOLS**

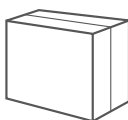

Ref.	L [mm]	W [mm]	☒	EAN
16B243	430	200	0/4	5902062090416
16B244	600	200	0/3	5902062092243



## Kółko tnące

Cutting wheel / Schneiderad / Нож запасной / Ролун різучий / Csempévágókerék / Rezerva cutter tevi / Řezné kolečko / Koliesko na rezanie / Rezilno kolo / Pjovimo ratukas / Griezējirullis / Ketasnuga / Режущо колесо / Rezni kotačić / Тоčак за rezanje / Ράουλο κοπής / Recambio rueda para cortatubos / Lama rotonda per taglia piastrelle / Roda cortante / Roue de coupage / Snijwiel

**NEO**  
TOOLS

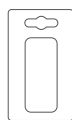

Ref.	ø [mm]	⊠	EAN
56-006	16	0/50	5907558409932

**T TOPEX**

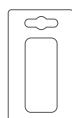

Ref.	L [mm]	Info	⊠	EAN
16B328	22x5x2	16B270 - 16B273	10/250	5902062092663
16B330	22x10.5x2	16B280 - 16B282	10/500	5902062092670

**T TOPEX**

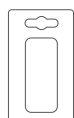

Ref.	Info	⊠	EAN
16B316	do 16B230	10/400	5902062091246
16B318	do 16B240; 16B260	10/400	5902062091253
16B322	do 16B140; 16B160	10/300	5902062091260
16B324	do 16B055-16B085; 16B050-16B080	0/50	5902062204011

## Wyciskacz do tub

Caulking gun / Auspresser für Tuben / Выжиматель / Топок для витиснання монтажноі піни / Kinyomópisztoly / Comprimator de tuburi / Aplikáční pistole na tuby / Vytlačáč túb / Pištola za tube / Hermetiko pistoletas / izspiedējs / Torutõmmits / Изтискивач за туби / Istiskivač za tube / Istiskivač za tube / Πιστόλι αλικόνης / Pistola para tubos / Pistola per cartucce / Espremedor para tubos / Pistolet pour tubes / Afdichtingspistool

**NEO**  
TOOLS



Ref.	V [ml]	L [mm]	⊠	EAN
61-005	310	254	0/12	5907558420838
61-006	600	389	0/12	5907558420845

**NEO**  
TOOLS



Ref.	L [mm]	⊠	EAN
61-001	240	0/24	5907558405842

**NEO**  
TOOLS



Ref.	L [mm]	⊠	EAN
61-002	240	0/12	5907558405859

**NEO**  
TOOLS

**HEAVY DUTY**



3 trzpienie wyciskające  
3 forcing pins  
3 отжимных штифта

Ref.	L [mm]	⊠	EAN
61-004	240	0/12	5907558420821

**T TOPEX**



21B330-1

Ref.	V [ml]	⊠	EAN
21B330	300	0/20	5902062213303
21B360	600	0/20	5902062213600
21B330-1	-	0/1000	5902062121783

**T TOPEX**

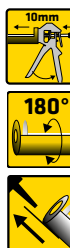

Ref.	⊠	EAN
21B336	0/20	5902062121097





## Wyciskacz do tub

Caulking gun / Auspresser für Tuben / Выжиматель / Толок для витискання монтажноі піни / Kinyomópisztoly / Comprimator de tuburi / Aplikáční pistole na tuby / Vytlačáč túb / Pištola za tube / Hermetiko pistoletas / izspiedējs / Torutõmmits / Изтискувач за тубу / Istiskivač za tube / Istiskivač za tube / Πιστόλι σιλικόνης / Pistola para tubos / Pistola per cartucce / Espremedor para tubos / Pistolet pour tubes / Afdichtingspistool

**TOPEX**



Ref. 21B235  
EAN 5902062120816  
0/20

**TOPEX**

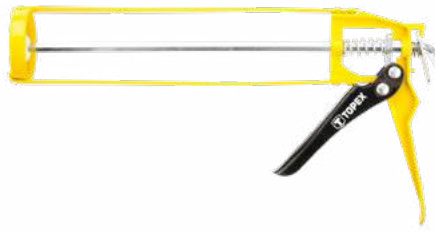
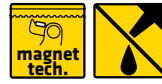

Ref. 21B245  
EAN 5902062120342  
0/24

**TOP TOOLS**



Ref. 21B131  
EAN 5902062120335  
0/24

## Pistolet do pianki

Foam gun / Schaum-Pistole / Пистолет для пены / Пистолет до монтажноі піни / Habpisztoly / Pistol de spumă / Pěnová pistole / Aplikáční pištol na penu / Pištola za peno / Montavimo putų pistoletas / Putu pistole / Vahupüstol / Пистолет за пѐна / Pištolj za rjenu / Pištolj za penu / Πιστόλι αφρού / Pistola surtidora de espuma / Pistola per schiuma / Pistola p. espuma / Pistolet à mousse / Schuimpistool

**NEO TOOLS**

PTFE adapter  
Переходник из PTFE



Ref. 61-011  
EAN 5907558409123  
0/12

**NEO TOOLS**

NICKEL PLATED



Ref. 61-012  
EAN 5907558412222  
0/20

**NEO TOOLS**



Ref. 61-013  
EAN 5902062009838  
0/20



**NEO TOOLS**



Ref. 61-014  
EAN 5902062009821  
0/20



**TOPEX**

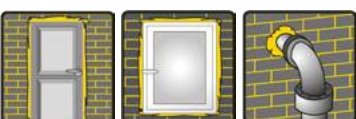

Ref. 21B501  
EAN 5902062215017  
0/20

**TOPEX**

PTFE adapter  
Переходник из PTFE

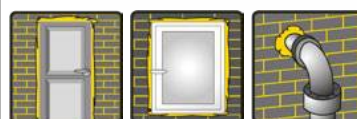

Ref. 21B504  
EAN 5902062215048  
0/20



## Pistolet do pianki

Foam gun / Schaum-Pistole / Пистолет для пены / Пистолет до монтажноі піни / Habpisztylo / Pistol de spumă / Pěnová pistole / Aplikáčnà pištoľ na penu / Pištoľ za peno / Montavimo putų pistoletas / Putu pistole / Vahupüstol / Пистолет за пјана / Pištoľj za pjenu / Pištoľj za penu / Πιστόλι αφρού / Pistola surtidora de espuma / Pistola per schiuma / Pistola p. espuma / Pistolet à mousse / Schuimpistool

**TOPEX**

**PTFE**

**TOP TOOLS**

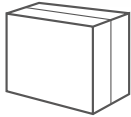
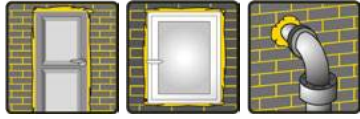

Ref.	📦	EAN
21B507	0/20	5902062009807

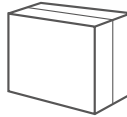

Ref.	📦	EAN
21B503	0/20	5902062215031

**TOP TOOLS**



Ref.	📦	EAN
21B510	0/100	5902062035714

**TOP TOOLS**

PTFE adapter  
Переходник из PTFE

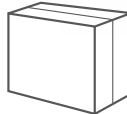

Ref.	📦	EAN
21B509	0/12	5902062011183

## Skrobak

Scraper / Kratzer / Скребок / Шерхебель / Ablakkaparó / Ráztaoare / Škrábák / Škrabka / Strgalo / Grandiklis / Skrāpis / Kaabits / шабър / Strugaljka / Spahtla / Ξύστρα / Rasqueta / Spatola / Rascador / Grattoir / Krabber

**TOPEX**

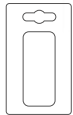

Ref.	L [mm]	W [mm]	📦	EAN
18B526	310	100	0/96	5902062092229

**TOPEX**

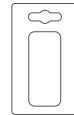

Ref.	L [mm]	📦	EAN
16B471	210	10/60	5902062092045

## Ostrza do skrobaka

Blades for scraper / Klingen für Schraber / Лезвия для скребка / Леза до скребка / Fugatisztőbetét / Lame pentru raziitor / Čepel na škrábku / Čepele do škrabky / Rezila za strgalo / Peililai gremžtukui / Skrāpja asmeņi / Kraabitsa terad / Остриета за шабър / Oštrice za nožić / Oštrice za strugač / Λάμες για ξύστρα / Hojas para rasqueta / Lame perraschietto / Lâminas p. Rascadora / Lames à grattoir / Krabberbladen

**TOPEX**

**x10**

**TOPEX**

**x2**

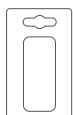

Ref.	L [mm]	📦	EAN
18B527	100	24/192	5902062092236

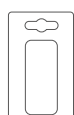

Ref.	📦	EAN
16B471-1	0/400	5902062092205



## Skrobak

Scraper / Kratzer / Скребок / Шерхбель / Ablakkararó / Ráztaoare / Škrabák / Škrabka / Strgalo / Grandiklis / Skrápis / Kaabits / шабёр / Strugaljka / Spahtla / Ξύστρα / Rasqueta / Spatola / Rascador / Grattoir / Krabber

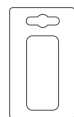

Ref.	L [mm]	W [mm]	⊠	EAN
18B550	145	51	120/360	5902062140326

## Szczypce do glazury

Tile cutting pliers / Fliesenzange / Клещи для плитки / Щипцы для плитки глазуrowаной / Παραγάφογ / Clește p/lu plăci de teracotă / Kleště na glazuru / Klešte rezacie a lámacie na obkladačky / Klešče za rezanje ploščic / Replés plyteléms / Knaibles flīzēm / Nāpītsad plaadi lōikamiseks / Клещи за фаянс / Klješta za sjećenje pločica / Klesta za secenje pločica / Σπάσης Πλακιδίων / Pinzas para azulejos / Pinza taglia piastrelle / Pinças p. azulejos / Pince à carrelage / Glazuurtang

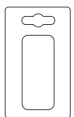

Ref.	L [mm]	⊠	EAN
16B440	200	6/36	5902062091482

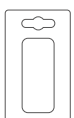

Ref.	L [mm]	⊠	EAN
16B441	200	5/50	5902062092212

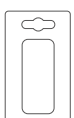

Ref.	L [mm]	⊠	EAN
16B430	210	0/60	5902062091277

## Nóż do glazury

Tile knife / Fliesenmesser / Нож для нафельной плитки / Нож для плитки / Kézi csempévágó / Čužit teracotă / Nůž na glazuru / Nůž na keramiku / Nož za ploščice / Peilis plyteléms / Nazis flīzēm / Pladinuga / Нож за фаянс / Nož za pločice / Noz za pločice / Κοπική λεπίδα για πλακίδια / Cuchillo cortador de azulejos / Coltello per piastrelle / Faca para azulejos / Couteau à carrelage / Glazuurmes

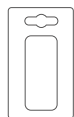

Ref.	L [mm]	⊠	EAN
16B420	170	0/50	5902062090232

## Wycinarka otworów w glazurze

Adjustable hole cutter / Fliesenstichsäge / Сверло для плитки / Викружальник регульований / Kōrkivágó csempéhez / Mecanism de reglare perforare găuri / Fréza na díry v glazuře / Vykrúžovák na obkladačky / Urezovalec lukenj v ploščice / Prietaisais ertmių pjovimui plytelėse / Saurumzāģis / Tellitav augulōikur / Буреля за фаянс / Podešavajúci Sječač / Sekas za rupe / Ρυθμιζόμενη Πένσα Πλακά / Sacabocado para azulejos / Fresa per piastrelle / Serra de contorno para azulejos / Découpeuse d'ouvertures dans le carrelage / Gatelknipper voor glazuur

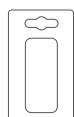
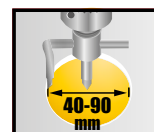

Ref.	Ø otworu [mm]	⊠	EAN
16B460	40-90	0/50	5902062090270

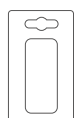
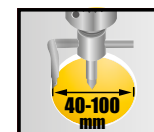

Ref.	Ø otworu [mm]	⊠	EAN
16B451	40-100	3/36	5902062091536

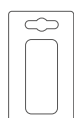

Ref.	Ø [mm]	⊠	EAN
16B450	10-50	6/36	5902062091475



## Kliny dystansowe

Tile wedges / Abstandskeile / Клинья / Клинци для плитки / Csempek / Pene acoperiş / Distanční klíny / Klin distančný / Distančni klini / Pleištai plytelėms / Distances çılıs / Plaadikiilud / Клинове / Klin za pločice / Klin za pločice / Στήρες αποστασιοποίησης / Cunha para azulejos / Distanziatori per piastrelle / Cunhas de distância / Cales d'entretoises / Abstandswiggen

NEO  
TOOLS

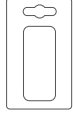

Ref.	W [mm]	N	☒	EAN
61-122	35	x50	0/100	5907558481556
61-123	28	x100	0/100	5907558481563

## Krzyżki dystansowe

Cross distancers / Abstandskreuze / Крестики / Хрестики дистанційні / Hézagolókerezst / Cruciułiti p/u distantã / Distančni křížky / Křížik distančný / Distančni křížci / Krzyżkiuki plytelėms / Flīžu krustiņi / Ristkiilud / Ограничител за фугу / Křížci / Křstici / Αποστασιοποιητές πλακιδίων / Crucetas separadoras para azulejos / Distanziatori per piastrelle a croce / Separador / Entretoises de croix / Abstandskruizen

NEO  
TOOLS

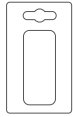

Ref.	W [mm]	N	☒	EAN
61-106	1	x200	0/100	5907558481396
61-107	1.5	x200	0/100	5907558481402
61-108	2	x200	0/100	5907558481419
61-109	3	x150	0/100	5907558481426
61-110	2.5	x150	0/100	5907558481433
61-111	4	x100	0/100	5907558481440
61-112	5	x100	0/100	5907558481457

NEO  
TOOLS

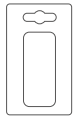
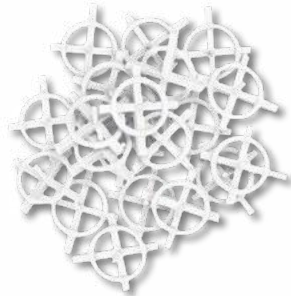

Ref.	W [mm]	N	☒	EAN
61-113	1	x100	0/100	5907558481464
61-114	1.5	x100	0/100	5907558481471
61-115	2	x100	0/100	5907558481488
61-116	3	x100	0/100	5907558481495
61-117	4	x100	0/100	5907558481501

NEO  
TOOLS

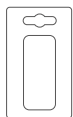
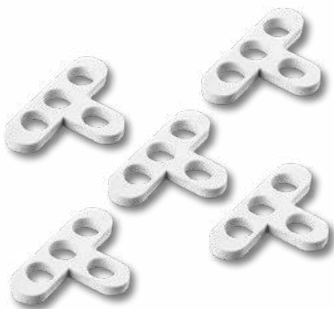

Ref.	W [mm]	N	☒	EAN
61-118	10	x30	0/100	5907558481518
61-119	8	x30	0/100	5907558481525
61-120	5	x50	0/100	5907558481532
61-121	6	x50	0/100	5907558481549

## Uchwyty magnetyczne do płytek

Magnetic tile holders / Magnetfliesenhalterungen / Держатели магнитные для плиток / Магниту для плитки / Mágneses csempe tartó / Dispozitiv magnetic fixare plăci / Magnetické držky na obkládačky / Úchytky magnetické na obkládačky / Magnetna držala za ploščice / Magnetinis plytelių laikiklis / Turētājs fizēm magnētisks / Magnetplaadihoidjad / Шнаперу за плочки / Magnetni Držac pločica / Magnetni držac pločica / Μαγνητική θήκη συγκράτησης για πλακίδια / Plaquitas magnéticas de sujeción para azulejos / Supporto magnetica per piastrelle / Suportes magnéticos p. azulejos / Porte-plaquettes magnétiques / Magnetische houders voor tegels

TOPEX



x4

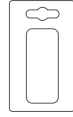

Ref.	☒	EAN
16B480	10/50	5902062202048

## Fugownica gumowa

Rubber spreader / Gummi-Fugengerät / Шпатель для фуговки / Шпаделя гумова / Fugázógumi / Spaciu pentru rosturi / Stěrka pryžová / Gumená stierka / Gumijasto orodje za fugiranje / Guminė glaistyklė, siulėms / Gumijas lāpstiņa špaktelēšanai / Kummist vuugilabidas / Гумирана мапуна за фугуване / Gumeni stroj za fugiranje / Uredaj za širenje gume / Σπάτουλα ελαστική / Esparcidor con lengüeta de goma / Spatola riempigiunto / Máquina de pôr junta de borracha / Taloché pour joints en caoutchouc / Rubberen voegpistool

TOPEX



Ref.	L [mm]	☒	EAN
13A620	200	10/300	5902062091383
13A630	300	10/180	5902062091390

## System poziomowania płytek

The system of quick tiles levelling / Fliesennivellierungssystem / Система для выравнивания плитки / Система вирівнювання нахлю / Lapszintező rendszer / Sistem de nivelare a plăcilor ceramice / Nivelacní systém pro obklady / Systém na vyrovnávání dlaždic / Sistem za niveliranje keramičnih ploščic / Plytelių lyginimo sistema / Flīžu līmeņošanas sistēma / Plaattide loodimise süsteem / Система за нивелување на плочки / Sustav za niveliranje ploča / Sistem za izravnavanje ploča / Σύστημα αλφριθμάτος πλακιδίων / Sistema para nivel baldosas / Sistema di livellamento per piastrelle / Sistema de nivelamento de ladrilhos / Système de mise à niveau de carreaux / Tegel nivelleer systeem

NEO  
TOOLS

x50

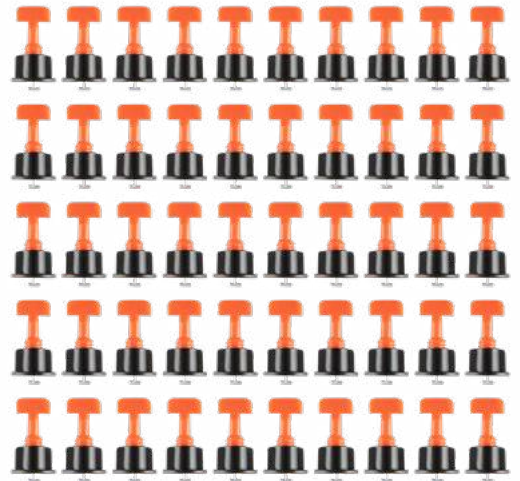

Ref.	N	☒	EAN
61-105	x50	0/40	5907558463590

NEO  
TOOLS



x200

x100

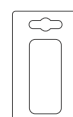

Ref.	W [mm]	N	☒	EAN
61-100	1.5	100+200	0/1	5907558454291
61-102	1	100+200	0/1	5907558458817



## Klipsy do poziomowania płytek

Clips for system of quick tiles levelling / Clips zur Fliesenivellierung / Зажимы для выравнивания плитки / Клипсы для выравнивания кахлю / Lapszintező klipszek / Cleme pentru nivelarea plăcilor / Spony pro nivelaci obkladů / Klipy na vyrovnávanie dlaždíc / Zagazde za keramične ploščice / Płyteļu lyginimo klipai / Fižu līmeņošanas ķīli / Plaatide loodimise klambriid / Скобы за нивелуране на плочки / Корџе за niveliranje ploča / Isecci za izravnavanje ploča / Σφιγκτήρες για αλφάδιασμα πλακιδίων / Elementos para nivelat baldosas / Clip per il livellamento di piastrelle / Clipses para nivelamento de ladrilhos / Attaches pour mise à niveau de carrelages / Klemmen voor het nivellieren van tegels

NEO  
TOOLS

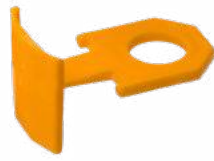

x 150



Ref.	W [mm]	N	☒	EAN
61-101	1.5	150	0/15	5907558454307
61-103	1	150	0/15	5907558458824

## Pistolet do systemu poziomowania

Tile leveling pier / Fliesenivellierzange / Пистолет для системы выравнивания / Пистолет для системи вирівнювання / Pisztyl szintező rendszerhez / Pistol pentru sistemul de nivelare / Pistole pro nivelační systém / Pistoľ na vyrovnávací systém / Kleščice za niveliranje ploščic / Pistoletas išlyginimo sistemat / Limeņošanas sistēmas pistole / Pistol tasandussüsteemi jaoks / Пистолет за система за нивелуране / Pistoľ za sústav niveliranja / Ταλάρα για σύστημα αλφάδοποίησης / Pistola para sistema de nivelación / Pistola per sistema di livellamento / Pistola para sistema de nivelamento / Pistolet pour système de nivellement / Pistol voor nivelleringsysteem

NEO  
TOOLS



Ref.	☒	EAN
61-104	20/40	5907558459715

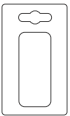

## Zestaw do silikonu 3 w 1

3 in 1 silicone kit / 3 in 1 Silikon-Kit / Набор силикона 3 в 1 / 3 az 1-ben szilikon készlet / Kit de silicon 3 în 1 / Silikonová sada 3 v 1 / Silikonová súprava 3 v 1 / Silikonski komplet 3 v 1 / Silikono rinkinys 3 viename / 3 in 1 silikona komplekts / Комплект силикон 3 в 1 / Kit de silicona 3 en 1 / Kit di silicone 3 in 1 / Kit de silicone 3 em 1 / Kit silicone 3 en 1 /

NEO  
TOOLS



Ref.	☒	EAN
56-014	25/100	5907558483659

## Wałek do odpowietrzenia wylewek

Deaeration roller / Welle zur Entlüftung von Fußböden / Валик изгольчатый для наливных полов / Валик голастий (для наливных поверхностей) / Tűskés henger / Rolă de evacuarea aerului/formatare sapa / Odvzdušňovací váleček / Valček na odvzdušňovanie / Valj za odzračevanje / Volelis nuorinimui / Adatu veltnītis / Βετοοιθιηυσrull / Иглен обезвъздушващ валик / Valjak za odzračivanje / Valjak za ventiliranje otvora / Ρολό αφαίρεσης φυσαλίδων / Rodillo anti-burbujas / Rullo frangibolle / Rolo para retirar ar / Rouleau à désaérer le mortier / Roller voor ontluftung van opstortingen

TOPEX

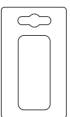

Ref.	L [mm]	wys. kolców [mm]	rodzaj	☒	EAN
20B801	250	14	drobny	0/15	5902062206077

## Mieszadło do zapraw

Mortar mixer / Mörtelrührer / Мешалка для растворов / Мішалка до чамуру будівельного / Festékkeverőszer / Mixer ciment / Mišaćka malty / Miesać na maltu / Mešalnik za barvo / Maišyklė skiediniui / Mikseris massām / Mördsjegisti / Бърналка / Mikser za boju / Mikser za boju / Αναδευτήρας κονιάματος / Varilla para mezclador de mortero / Pala per miscelare la malta / Misturador p. Argamassa / Agitateur à mortier / Mortelmixer

NEO  
TOOLS

M14

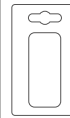

Ref.	L [mm]	☒	EAN
56-020	100	0/24	5907558440256
56-021	120	0/16	5907558440263

NEO  
TOOLS

SDS

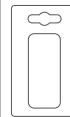

Ref.	L [mm]	☒	EAN
56-022	100	0/24	5907558440270
56-023	120	0/24	5907558440287

NEO  
TOOLS

HEX



Ref.	L [mm]	☒	EAN
56-024	80	0/60	5907558440294
56-025	100	0/30	5907558440300

## Mieszadło do gipsu

Plastering mixer / Gipsrührer / Мешалка для гипса / Мішалка до гіпсу / Festékkeverőszer / Mixer ghips / Mišaćka sádry / Miesać na sádrú / Mešalnik za gips / Maišyklė gipsui / Mikseris gipsim / Krohvisjegisti / Бърналка / Mikser za boju / Mikser za boju / Αναδευτήρας σβαντιάματος / Varilla para mezclador de yeso / Pala per miscelare il gesso / Misturador p. Gesso / Agitateur à plâtre / Gipsmixer

NEO  
TOOLS

HEX

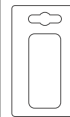

Ref.	L [mm]	☒	EAN
56-026	80	0/60	5907558440317
56-027	100	0/30	5907558440324



## Mieszadło do farb i klejów

Paint mixer / Rührer für Farben und Kleber / Мешалка для лакокрасочных материалов / Насадка до змішування фарб і клеїв / Festékkeverőszár / Agitator/mixer de vopsele și cleiuri / Michadlo na barvy a lepidla / Mieszadło na farbę a lepidlá / Mešalo za barve in lepila / Maišyklė dažams ir klijams / Krāsu un līmju maišītājs / Värvi- ja liimivispel / Бъркачка за боя и лепило / Mešalica za boje i ljepilo / Mešalica za farbú i lepak / Αναδευτήρας χρωμάτων και κόλλας / Varilla para mezclador de pintura y pegamento / Pala per miscelare vernice e colla / Misturador p. Tintas / Agitateur de peinture / Mixer voor verf en lijm

NEO  
TOOLS

HEX



Ref.	L [mm]	☒	EAN
56-028	80	0/40	5907558440331
56-029	100	0/20	5907558440348

## Таśма маларска

Masking tape / Malerband / Лента малярна / Стрічка мулярська / Krepp szalag / Bandă de mascare / Malířská páska / Páska krycía / Zaštitni trak / Juosta dažymo darbams / Limlenta krāsosānai / Maalriteip / Тиско хартиено / Креп трака / Трака / Ταΐνια κάλυψης / Cinta de pintor / Nastro maschera / Fita p. pintura / Bande de peinture / Verfband

TOPEX



Ref.	W [mm]	L [m]	☒	EAN
23B203	30	36	0/32	5902062121165
23B205	38	36	6/24	5902062232052
23B204	48	36	6/24	5902062121172

## Таśмы uszczelniające do rur

Pipe sealing tapes / Dichtungsbänder für Rohre / Набор лент тефлоновых уплотнительных / Стрічки ущільнювальні тефлонові для труб / Csőtömítő szalagok / Banda izolatoare / Těsnící pásky pro trubky / Pásky tesniace na rúry / Tesnilni trakovi za cevi / Sandarinimo juostos, vamzdžiams / Teflona blīvventas komplekts / Isolatsiooniint torudele / Уплътнителна лента за тръби / Трачна brtvila za cijevi / Pričvršne trake za cevi / Σετ στεγανοποιητικών ταϊνιών τεφлон / Cintas de calafateo / Nastri sigillanti per tubi / Fitas vedantes p. tubos / Bandes d'étanchéité pour tubes / Afdichtingsbanden voor buizen

NEO  
TOOLS



10m  
x  
12mm

0.075  
mm

Ref.	W [mm]	L [m]	N	☒	EAN
02-030	12	10	x5	100/200	5907558440355
02-031	12	10	x2	2/400	5907558440362

NEO  
TOOLS



15m  
x  
19mm

0.2  
mm

Ref.	W [mm]	L [m]	☒	EAN
02-032	19	15	10/400	5907558440379

## Таśма uniwersalna

Universal tape / Universalband / Лента универсальная / Стрічка універсальна / Ragasztószalag / Bandă universală / Univerzální páska / Páska lepiaca Univerzálna / Univerzalni trak / Univerzali juosta / Lenta universală / Univerzalteip / Тиско армурано / Univerzalna DUCT traka / Univerzalna traka / Ταΐνια γενικής χρήσης / Cinta universal reforzada DUCT TAPE / Nastro telato universale / Fita universal / Bande universelle / Universele band

TOPEX



Ref.	W [mm]	L [m]	☒	EAN
24B120	48	9	0/36	5902062241207

## Таśма двусторонна

Double sided tape / Band, beidseitig / Лента двухсторонняя / Стрічка клеїтка двобічна / Ragasztószalag kétoldalas / Bandă dublu adeziva/mochete / Oboustranná páska / Obojstranná páska / Dvostranski trak / Dvipusé juosta / Divpusēja līmente / Каһерpoolne teip / Двусторонна лента / Dvostrana traka / Dvostrana traka / Αυτοκόλλητη ταΐνια διπλής όψης / Cinta doble / Nastro biadesivo / Fita de dois lados / Bande double face / Dubbelzijdige band

TOPEX



Ref.	W [mm]	L [m]	☒	EAN
23B222	50	10	0/36	5902062232229
23B224	50	25	0/24	5902062232243

## Таśма naprawcza

Repair tape / Ремонтная лента / Ремонтна стрічка / Javítószalag / Repararea benzii / Páska opravná / Opravná páska

NEO  
TOOLS



48mm  
x  
20m

Ref.	W [mm]	L [m]	☒	EAN
56-040	48	20	0/24	5907558446463

## Таśма pakowa

Packing tape / Packband / Скотч упаковочный / Шліфмашинка стрічкова / Ragasztószalag / Bandă pentru ambalat / Balící páska / Baliaca páska / Trak za pakiranje / Pakavimo juosta / Lesaiņošanas lente / Pakkimesteip / Упаковочна лента / Traka za pakiranje / Traka za rakovanje / Κολλητική ταΐνια συσκευασίας / Cinta para embalar / Nastro da imballo / Fita especial / Bande d'emballage / Verpakkingsband

TOPEX



Ref.	W [mm]	L [m]	☒	EAN
24B121	48	35	6/36	5902062241214
24B122	48	35	0/36	5902062130655



## Taśma ostrzegawcza

Warning tape / Warnstreifen / Лента оградительная / Стрічка застережна / Jelölőszalag / Bandă de încălzire / Výstražná páska / Páska výstražná / Opozorilni trak / Ispėjamoji juosta / Drošības zonas lenta / Soojendusteip / Лента сигнальна / Traka za upozoravanje / Traka za upozoravanje / Αυτοκόλλητη Ταβία Προειδοποίησης Κινδύνου / Cinta de seguridad / Nastro segnaletico / Fita de advertência / Bande d'avertissement / Waarschuwingsband

**TOPEX**



Ref.	W [mm]	L [m]	☒	EAN
24B150	80	90	0/36	5902062241504

## Taśma izolacyjna

Insulating tape / Isolierband / Лента изоляционная / Стрічка ізоляційна / Szigetelőszalag / Banda izolatoare / Izolační páska / Páska izolačná / Izolacijski trak / Izolavimo juosta / Izolācijas lenta / Isoleerteip / Izolir traka / Ταβία μόνωσης / Nastro izolante / Fita de isolação / Bande isolante / Isolatieband

**NEO TOOLS**



Ref.	W [mm]	L [m]	kolor	☒	EAN
01-528	15	10		0/500	5907558439335
01-526	15	10	■	0/500	5907558439311

**TOP TOOLS**



Ref.	W [mm]	L [mm]	kolor	☒	EAN
24B108	19	10	■	0/500	5902062130143
24B111	19	10	□	0/500	5902062130167
24B113	50	10	■	0/200	5902062130150

**TOP TOOLS**



Ref.	W [mm]	L [mm]	☒	EAN
24B115	19	3	50/200	5902062130174

## Nóż modelarski, 3 ostrza

Precision knife, 3 blades / Messer, 3 Klängen für Modellbauzwecke / Нож моделіста, 3 лезвія / Ніж моделіста, 3 леза / Dekorkés készlet / Cuijt de modelat, 3 lame / Modelářský nůž, 3 břity / Modelársky nôž, 3 čepele / Modelarski nož, 3 rezila / Modelavimo peilis, 3 geležtės / Modelēšanas nazis, 3 asmeņi / Hobinuga, 3 tēra / Моделерски нож, 3 оструета / Rezbarski nož, 3 ostrice / Modelarski nož, 3 ostrice / Μαχαίρι μοντελισμού, 3 λεπίδες / Cuchillo de precisión, 3 hojas / Coltello di precisione / Faca de modelação / Couteau de modelage / Precisie mes, 3 lemmeten

**TOPEX**

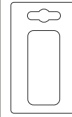

Ref.	L [mm]	☒	EAN
17B703	155	24/288	5902062141040

## Nóż modelarski, 16 ostrzy

Precision knife, 16 blades / Messer, 16 Klängen für Modellbauzwecke / Нож моделіста, 16 лезвіїв / Ніж моделіста, 16 лез / Dekorkés készlet / Cuijt de modelat, 16 lame / Modelářský nůž, 16 břity / Modelársky nôž, 16 čepele / Modelarski nož, 16 rezila / Modelavimo peilis, 16 geležtės / Modelēšanas nazis, 16 asmeņi / Hobinuga, 16 tēra / Моделерски нож, 16 оструета / Rezbarski nož, 16 ostrice / Modelarski nož, 16 ostrice / Μαχαίρι μοντελισμού, 16 λεπίδες / Cuchillo de precisión, 16 hojas / Coltello di precisione / Faca de modelação / Couteau de modelage / Precisie mes, 16 lemmeten

**TOP TOOLS**



x16

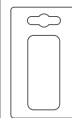

Ref.	N	☒	EAN
17B716	x16	0/100	5902062140333

## Osełka

Whetstone / Schleifstein / Брусоч точильный / Точила / Fenőkö / Piatră abrazivă / Brousek / Osla / Osla / Galastuvas / Galoda / Luisk / Брус / Brus / Brus / Πέτρα ακονίσματος / Taco de lijar / Pietra per affilare / Pedra de amolar / Pierre à aiguiser / Slijpsteen

**NEO TOOLS**



56-007

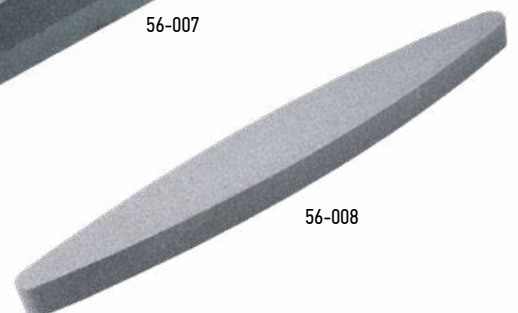

56-008

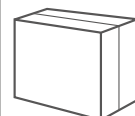

Ref.	W [mm]	L [mm]	H [mm]	gradacja	☒	EAN
56-007	50	150	25	K200/K100	25/50	5907558440232
56-008	35	230	13	K180	0/100	5907558440249



## Nożyczki

Scissors / Schere / Ножницы / Ножуци / Olló / Foarfeca / Nůžky / Nožnice / Škarje / Žirkles / Šķēres / Käärid / Ножуци / Škarice / Makaze / Ψαλίδι / Tijeras / forbice da elettricista / Tesoura / Ciseaux / Schaar

**NEO**  
TOOLS

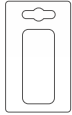

Ref.	L [mm]	☒	EAN
64-001	230	12/72	5907558485462

**TOPEX**

**STAINLESS STEEL**  
Hardened

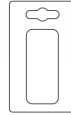

Ref.	L [mm]	☒	EAN
17B714	140	12/288	5902062177148
17B722	220	12/144	5902062177223

**TOPEX**

**STAINLESS STEEL**

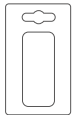

Ref.	L [mm]	☒	EAN
32D413	140	12/120	5902062007728

**TOP TOOLS**

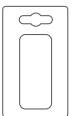

Ref.	W [mm]	☒	EAN
17B721	215	12/144	5902062200020

**TOP TOOLS**

**x3**

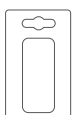

Ref.	W [mm]	W [mm]	W [mm]	☒	EAN
17B723	140	160	210	10/40	5902062141095





A mechanic in a dark grey uniform is working on the underside of a car. He is holding a flashlight in his right hand, illuminating the engine area. In the foreground, another person is holding a portable work light with two circular lamps, which is also illuminating the scene. The work light has orange handles and a black base. The background shows the complex metal parts of the car's engine and chassis.

# OŚWIETLENIE

WORKSHOP LIGHTING ОСВІТЛЕННЯ

# Latarka

Torch / Taschenlampe / Фонарик / Ліхтарик / Alumínium 2az1-ben zseblámpa/vizsgólámpa / Lanterna / Baterka / Lampa / Svetilka / Žibintuvelis / Lukturis / Pöleti / Фенерче / Baterijska / lampa / Lampa / Φακός / Linterna de mano / Torcia / Lanterna / Torche / Zaklamp

**NEO**  
TOOLS

3W 300 max lm	CREE XPE+COB LED	ALUMINIUM BODY	BATTERY Li-Ion 3.7V 2000mAh
3h charging	POCKET CLIP	small size	EDC compatible

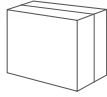

Ref. EAN  
99-034 50/100 5907558451443

ROTATING	USB charging	MAGNETIC
----------	-----------------	----------

**NEO**  
TOOLS

10W 1000 max lm	250 m	ZOOM	BATTERY Li-Ion 3.7V 2200mAh	OSRAM P9 LED
BATTERY INDICATOR	USB charging cable	IPX4	4.5h charging	

1st click:

100%  
min 3 h

+ 1st click:

40%  
max 7 h

+ 2nd click:

10%  
max 25 h

2nd click:  
**OFF**

click + hold:

**STROBE**

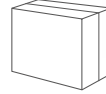

Ref. EAN  
99-035 20/40 5907558451450

**NEO**  
TOOLS

30W 3300 max lm	BATTERY Li-Ion 3.7V 4000mAh	OSRAM P9 LED	220 m
ALUMINIUM BODY	USB charging cable	6h charging	IPX4

1st click:  
 3% max 60 h

1st click:  
 10% max 10 h

1st click:  
 40% max 3 h

4th click: **OFF**  
press 2 seconds:  
 100%  
max 45 sec.

double click:  
 **STROBE**

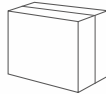

Ref. EAN  
99-037 20/40 5907558451474

**NEO**  
TOOLS

20W 1500 max lm	ALUMINIUM BODY	ZOOM	250 m	X6 AA	CREE XHP50.2 LED	3h work time
						IPX4

1st click: 100%

2nd click: **OFF**

3rd click: 20%

4th click: **OFF**

5th click: SOS  
strobe

light press: cycle modes



Ref. EAN  
99-036 4/24 5907558451467

**NEO**  
TOOLS

10W 800 max lm	BATTERY Li-Ion 3.7V 2000mAh	CREE T6+COB LED	USB charging cable	ALUMINIUM BODY
150 m	5h charging	IP20	small size	EDC compatible
				2in1

1st click:  
 100% max 5 h

2nd click:  
 50% max 10 h

3rd click:  
 SIDE 100% max 5 h

4th click:  
 SIDE STROBE

5th click: **OFF**

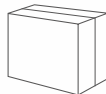

Ref. EAN  
99-033 0/50 5907558451436

**NEO**  
TOOLS

ZOOM	CREE XP-E2	3W max 200lm	waterproof IPX7 30min	X3 AAA	ALUMINIUM BODY
------	---------------	--------------------	-----------------------------	-----------	-------------------

100% 200lm  
⌚ 2h

50% 100lm  
⌚ 5h

stroboscope



Ref. EAN  
99-101 12/72 5907558425482



# Latarka

Torch / Taschenlampe / Фонарик / Ліхтарик / Aluminium 2az1-ben zseblámpa/vizsgálólámpa / Lanterna / Bateria / Lampa / Svetilka / Žibintüvelis / Lukturis / Pöleti / Фенерче / Baterijska / lampa / Lampa / Φακός / Linterna de mano / Torcia / Lanterna / Torche / Zaklamp

**NEO**  
TOOLS



- 10W 950m
- 500lm
- OSRAM LED
- BATTERY Li-ion 3.7V 4000mAh
- 4h charging
- 3h working
- USB C + cable
- 62.5x200mm
- ANODIZED FINISH
- IPX4

Ref. EAN  
99-070 4/24 5907558464948

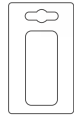

**NEO**  
TOOLS



- 10W 500LM
- SST20 LED
- 100m
- CHARGING TIME 3h
- 3.7V 800mAh Li-ion
- WORKING TIME 3h 130µA
- WORKING TIME 2h 500µA
- BATTERY INDICATOR
- ALUMINIUM BODY
- EDC
- IPX4

Ref. EAN  
99-074 10/40 5907558464986

**NEO**  
TOOLS



- 10W 1500LM
- SST40 LED
- 200m
- CHARGING TIME 4h
- 3.7V 4000mAh Li-ion
- BATTERY INDICATOR
- POCKET CLIP
- ALUMINIUM BODY
- IPX4
- WORKING TIME 2.5h 1500µA
- WORKING TIME 3h 900µA
- WORKING TIME 7h 350µA
- WORKING TIME 9h 200µA

Ref. EAN  
99-075 10/40 5907558464993

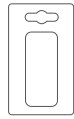

**NEO**  
TOOLS



- 20W 2000lm
- 180m
- CHN LED
- CAPACITY & CHARGING INDICATOR
- BATTERY Li-ion 3.7V 2200mAh
- USB C + cable
- POCKET CLIP
- 4h charging
- ALUMINIUM BODY
- ANODIZED FINISH
- IPX6

Ref. EAN  
99-067 6/48 5907558464917

**NEO**  
TOOLS



- 1st click:
- 50%
- 2nd click:
- 100%
- 3rd click:
- RED STROBE

- 4W 400 max lm
- x3 AA INCLUDED
- COB LED
- POCKET CLIP

Ref. EAN  
99-045 50/100 5907558452365

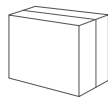

**NEO**  
TOOLS



- 3W 200 max lm
- COB LED
- ALUMINIUM BODY
- x3 AA
- IP20

Ref. EAN  
99-032 0/75 5907558451306

**NEO**  
TOOLS



- 100lm
- OSRAM P9 LED
- small size EDC compatible
- x1 AAA NOT INCLUDED
- 1h worktime
- 35m
- HEAD ROTATE on/off
- ALUMINIUM BODY
- ANODIZED FINISH
- 9g
- IPX4

Ref. EAN  
99-068 20/200 5907558464924

**NEO**  
TOOLS



- 2in1 4 LIGHT FUNCTIONS
- COB LED
- LASER
- 3w 90LM
- CHARGING TIME 30min
- WORKING TIME 40min
- 3.7V 120mAh Li-Pol
- RED LIGHT MODE
- ABS BODY
- 32.5mm x 32mm x 18mm
- 14g
- IPX4

Ref. EAN  
99-078 10/80 5907558465709



# Latarka czółowa

Headlamp / Stirnlampe / Фонарь налобный / Ліхтарик начільний / Fejlámpa / Lampă cap / Čelni baterka / Lampa čelová / Čelna svetilka / Žibintuvelis / Lukturītis uz pieres / Esilatern / Лампа за глава / Lampa za glavu / Rucna lamp / Φακός κεφαλής / Linterna de frente / Lampadina frontale / Lanterna de testa / Torche frontale / Hoofdzaklamp

**NEO**  
TOOLS

6W 600 max lm	90 m	CREE XPG3 LED	USB magnetic charging cable
small size EDC compatible	2h charging	BATTERY Li-ion 3.7V 700mAh	IPX4



- 1st click: 40% max 2 h
- 2nd click: 10% max 6 h
- 3rd click: OFF
- press 2 seconds: 100% max 40 sec.
- double click: STROBE

Ref. 99-027 EAN 10/80 5907558451252

**NEO**  
TOOLS

10W 1000 max lm	200 m	CREE L2 LED	USB charging cable
BATTERY Li-ion 3.7V 2000mAh	ALUMINIUM BODY	5h charging	IP20

- 1st click: 70% max 4 h
- 2nd click: 45% max 4 h
- 3rd click: 12% max 6 h
- long press: OFF
- press fast 2 times: 100% max 2.5 h
- + click 1: STROBE
- + click 2: SOS
- long press: OFF
- press 2 seconds: Red
- + click 1: STROBE
- + click 2: Blue
- long press: OFF



Ref. 99-028 EAN 0/50 5907558451269

**NEO**  
TOOLS

USB charging	10W 800 max lm	150 m	CREE XML T6 LED	ZOOM
IP20	BATTERY Li-ion 3.7V 1200mAh	4h charging		

- 1st click: 100% max 1.5 h
- 2nd click: 50% max 3 h
- 3rd click: STROBE
- 4th click: OFF



Ref. 99-026 EAN 56/112 5907558451245

**NEO**  
TOOLS

20W 2000 max lm	200 m	CREE XHP502 LED	USB charging cable	BATTERY Li-ion 3.7V 4000mAh
ALUMINIUM BODY			6h charging	IPX4

- 1st click: 40% max 5 h
- 2nd click: 15% max 9 h
- 3rd click: 3% max 60 h
- 4th click: OFF
- press 2 seconds: 100% max 40 sec.
- double click: STROBE



Ref. 99-029 EAN 10/40 5907558451276

**NEO**  
TOOLS

3W 180lm	COB LED	MOTION DETECTOR	BATTERY Li-ion 3.7V 500mAh	50 g
USB	ABS BODY	RED LIGHT MODE	1.5h charging	2.5h working
		CAP HOOK	IPX4	360°

- 1st click: 100%
- 2nd click: 40%
- 3rd click: RED
- 4th click: RED strobe
- long press: MOTION SENSOR



Ref. 99-069 EAN 6/48 5907558464931

**NEO**  
TOOLS

5 LIGHT FUNCTIONS	MOTION SENSOR	3W 250LM	XPE+ COB LED	ADJUSTABLE ANGLE	CAPHOOK	3.7V 1200mAh Li-ion
WORKING TIME 4h	BATTERY INDICATOR	RED LIGHT MODE	included USB	ABS+PC MATERIAL	CHARGING TIME 2.5h	



Ref. 99-073 EAN 25/50 5907558464979



## Latarka czółowa

Headlamp / Stirnlampe / Фонарь налобный / Лихтарик начільний / Fejlámpa / Lampă cap / Čelní baterka / Lampa čelová / Čelna svetilka / Žibintuvēlis / Lukturītis uz pieres / Esilatern / Лампа за глава / Lampa za glavu / Rucna lamp / Φακός κεφαλής / Linterna de frente / Lampadina frontale / Lanterna de testa / Torche frontale / Hoofdzaklamp

**NEO**  
TOOLS

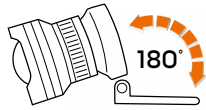

100% 400lm  
⌚ 2h

50% 200lm  
⌚ 5h

stroboscope

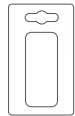

Ref. 99-200  
EAN 10/40 5907558425505

**NEO**  
TOOLS



100% 250lm  
⌚ 3h

50% 125lm  
⌚ 5h

stroboscope

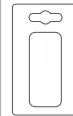

Ref. 99-201  
EAN 0/40 5907558425710

**T TOPEX**

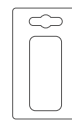
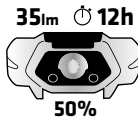
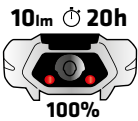
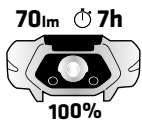

Ref. 94W390  
EAN 12/48 5902062024190

**T TOPEX**

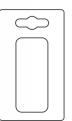

Ref. 94W391  
EAN 12/48 5902062055736

## Lampa biwakowa

Camping lamp / Campinglampe / Лампа для кемпінга / Кемпінг лампа / Кемпінглімпа / Lampă de camping / Camping lamp / Camping lamp / Svetilka za kampiranje / Stovyklavimo lempa / Kepinga lamp / Matkalamp / Лампа за къмпинг / Svjetiljka za kampiranje / Лампа за кампованье / Лампа кампінгук / Lámpara de camping / Lampada da campeggio / Lâmpada de acampamento / Lampe de camping / Camping lamp

**NEO**  
TOOLS



LAMP

TORCH



EMERGENCY  
RED LIGHT

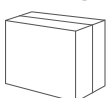

Ref. 99-030  
EAN 0/40 5907558451283

**NEO**  
TOOLS



3rd click:  
SIDE RED LIGHT  
max 7h

4rd click:  
SIDE RED STROBE

Ref. 99-031  
EAN 0/40 5907558451290



## Naświetlacz

Floodlight / Scheinwerfer / Прожектор / Прожектор / Diszkvilágítás / Proiector / Světlo / Svetlomet / Reflektor / Prožektorius / Floodlight / Floodlight / Прожектор / Reflektor / Φοοδοηχητ / Προβολέας / Luz de inundación / Proiettore / Floodlight / Projecteur / Schijnwerper

**NEO**  
TOOLS

10W  
750 max lm  
COB LED  
HANDLE/SUPPORT  
ABS  
IP20  
POWER BANK

- 1st click:  
100%
- 2nd click:  
50%
- 3rd click:  
STROBE
- 4th click: OFF



Zasilane 3xAA lub 2x18650  
Powered by 3xAA or 2x18650  
Работает на 3xAA или 2x18650

Ref. EAN  
99-038 0/40 5907558452297

**NEO**  
TOOLS

30W  
3000 max lm  
CHARGER INCLUDED  
SMD LED  
BATTERY Li-Ion 3.7V 8000mAh  
ABS + AL  
CAPACITY INDICATION  
POWER BANK  
USB C charger + cable  
4.5h charging  
ADJUSTABLE SUPPORT  
TRANSPORT HANDLE  
IP54  
210x180x55 mm

- 1st click:  
25% (750 lm)  
7-8 hrs
- 2nd click:  
50% (1500 lm)  
4 hrs
- 3rd click:  
100% (3000 lm)  
2 hrs
- 4th click: OFF



Ref. EAN  
99-064 0/10 5907558464887

**NEO**  
TOOLS

10W +3W  
750 +250 max lm  
CREE XPG LED  
HANDLE/SUPPORT  
POWER BANK  
BATTERY Li-Ion 3.7V 2600mAh  
ABS + TPR  
IP20  
USB charger + cable  
4.5h charging

- 1st click:  
Large LED  
100% max 2h
- 2nd click:  
Small LED  
100% max 5h
- 3rd click: OFF  
press 3 seconds:  
Both LEDs  
100% max 2min



Ref. EAN  
99-040 10/20 5907558452310

## Lampa warsztatowa

Workshop lamp / Werkstattlampe / Лампа переносная / Лампа переносна / Stekklámpa / Lampä atelier / Dilenskä lamp / Dielenská lamp / Delavniška svetilka / Lampa dirbtuvams / Pärnesjägamä lamp / Toökoja lamp / Лампа работна / Radna lamp / Radna lamp / Лампа εργαστηρίου / Lámpara de taller / Lampada da officina / Lâmpada de oficina / Lampe d'établi / Werkplaatslamp

**NEO**  
TOOLS

- 1st click:  
100%  
max 1.5 h
- 2nd click:  
50%  
max 3 h
- 3rd click:  
100%  
max 3 h
- 4th click: OFF
- press 2 seconds:  
RED LIGHT  
max 3 h
- + click 1:  
RED STROBE
- + click 2: OFF



3W  
200 max lm  
COB LED  
2in1 LAMP + TORCH  
BATTERY Li-Ion 3.7V 1200mAh  
FOLDING  
4h charging  
IP20  
USB charger + cable



Ref. EAN  
99-041 0/50 5907558452327

**NEO**  
TOOLS

- 1st click:  
100%  
max 2h
- 2nd click:  
30%  
max 7h
- 3rd click:  
OFF



FOLDABLE HOOK  
8W  
600 max lm  
SMD LED  
USB 5V/1A CHARGER INCLUDED  
BATTERY Li-Ion 3.7V 2200mAh  
IP54  
ABS  
4h charging  
IMPACT RATING IK08



FOLDABLE HOOK  
10W  
900 max lm  
SMD LED  
6500 K  
25000h work time  
IP54  
ABS  
LEDs x24  
363x50x50 mm  
IMPACT RATING IK08  
CRI Ra≥80  
CABLE 5m EU socket  
H05RN-F2 x1.0mm<sup>2</sup>  
230V 50Hz



Ref. EAN  
99-043 0/24 5907558452341  
99-044 0/16 5907558452358

**NEO**  
TOOLS

- 1st click:  
max 3.5 h
- 2nd click: OFF
- 3rd click:  
max 6 h
- 4th click: OFF



300 lm  
COB LED  
2in1 LAMP + TORCH  
x3 AA INCLUDED  
ABS

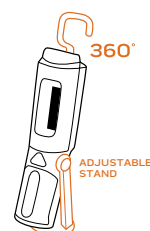

Ref. EAN  
99-042 0/24 5907558452334



## Lampa warsztatowa

Workshop lamp / Werkstattlampe / Лампа переносная / Лампа переносна / Steklámpa / Lampă atelier / Dílenská lampa / Díelenská lampa / Delavniška svetilka / Lampa dirbtuvėms / Pārnēsājāmā lampa / Töökoja lamp / Лампа работна / Radna lampa / Radna lampa / Λάμπα εργαστήριου / Lámpara de taller / Lampada da officina / Lámpada de oficina / Lampe d'établi / Werkplaatlamp

**NEO**  
TOOLS

- 2x 4.5W
- 2x350 lm
- 700 max lm
- 4000 K
- 2x BATTERY Li-ion 3.7V 2200mAh
- SMD LED
- 2h work time
- 2h charging
- CHARGER INCLUDED
- x6



Ref. EAN  
99-047 0/8 5907558452389

**NEO**  
TOOLS

- 10W
- 1000 max lm
- BATTERY Li-ion 3.7V 4000mAh
- SMD LED
- 3.5h work time
- 4.5h charging
- CHARGER INCLUDED
- x4

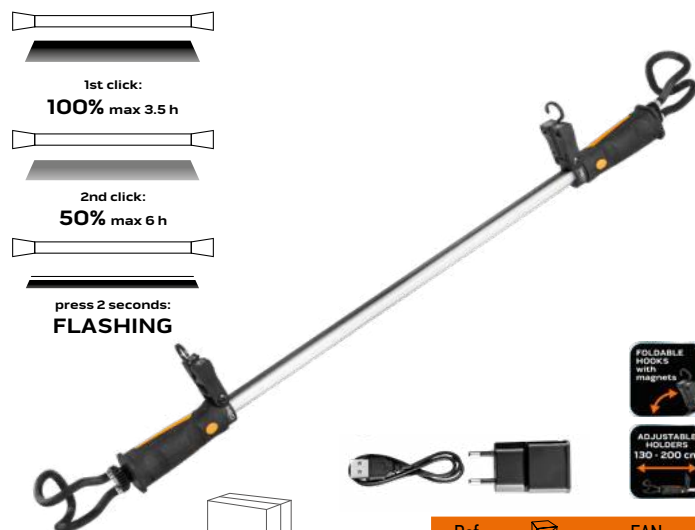

Ref. EAN  
99-048 1/4 5907558452396

**NEO**  
TOOLS

- CHARGER INCLUDED
- 2in1 lamp torch
- 5W+1W
- 500 lm
- COB LED
- CAPACITY INDICATION
- BATTERY Li-ion 3.7V 2600mAh
- HOOK
- MAGNETIC
- 3.5h charging
- 2-2.5h working
- ABS BODY
- DIMMING
- USB C charger + cable
- IP20
- 270x90x80 mm



Ref. EAN  
99-065 0/20 5907558464894

**NEO**  
TOOLS

- 6W
- 500lm
- COB LED
- BATTERY Li-ion 3.7V 2400mAh
- HOOK
- FOLDING CONSTRUCTION
- 3-4h charging
- max 4h (50%) working
- ABS BODY
- IP20
- 400x65x52 mm



Ref. EAN  
99-066 0/20 5907558464900

**NEO**  
TOOLS

- 2in1 LAMP + TORCH
- COB LED
- CHARGER INCLUDED
- cable included
- USB C
- DIMMING
- RED LIGHT MODE
- 360°
- CHARGING TIME 3h
- WORKING TIME 3h 3.5h LAMP TORCH
- 3.7V 2000mAh Li-ion
- BATTERY INDICATOR
- 10+5 W W
- 550+150 LM
- IP20



Ref. EAN  
99-071 10/20 5907558464955

**NEO**  
TOOLS

- 2in1 LAMP + TORCH
- COB LED
- POWERBANK
- cable included
- USB
- RED LIGHT MODE
- MOUNTING THREAD
- ADJUSTABLE STANDING BASE
- CHARGING TIME 3.5h
- WORKING TIME 3h 4h LAMP TORCH
- 3.7V 2000mAh Li-ion
- BATTERY INDICATOR
- 10+3 W W
- 500+150 LM
- IP20



Ref. EAN  
99-072 25/50 5907558464962



## Latarka inspekcyjna + laser + UV

Inspection lamp + laser + UV / Inspektionslampe + Laser + UV / Инспекционная лампа + лазер + УФ / Інспекційна лампа + лазер + УФ / Ellenőrző lámpa + lézer + UV / Lampa de inspectie + laser + UV / Inspekční lampa + laser + UV / Inšpekčná lampa + laser + UV / Inšpekcijska svetilka + laser + UV / Αρχιτεκτονική λάμπα + λέζερ + UV / Pārbaudes lampa + lāzers + UV / Kontrolllamp + laser + UV / Инспекционная лампа + лазер + UV / Inšpekcijska lampa + laser + UV / Inšpekcijska lampa + laser + UV / Λάμπα επιθεώρησης + λέιζερ + UV / Lámpara de inspección + láser + UV / Lampada di ispezione + laser + UV / Lámpada de inspeção + laser + UV / Lampe d'inspection + laser + UV / Inspectielamp + laser + UV

**NEO**  
TOOLS



Ref. EAN  
99-077 50/100 5907558465013

## Lampa + trójkąt ostrzegawczy

Lamp + warning triangle / Lampe + Warndreieck / Лампа + предупреждающий треугольник / Лампа + трикутник попередження / Lámpa + figyelmeztető háromszög / Lampă + triunghi de avertizare / Lampa + výstražný trojúhelník / Lampa + výstražný trojuholník / Svetilka + opozorilni trikotnik / Lampa + isprėjamasis trikampis / Lampa + brīdinājuma trīsstūris / Lamp + hoiatusnurk / Лампа + предупредителен триъгълник / Lampa + trokut upozorenja / Лампа + троугао упозорења / Λάμπα + προειδοποιητικό τρίγωνο / Lámpara + triángulo de advertencia / Lampada + triangolo di emergenza / Lámpada + triângulo de advertência / Lampe + triangle de présignalisation / Lamp + gevarendriehoek

**NEO**  
TOOLS



1st click:



2nd click:



3rd click:



4th click: OFF



Ref. EAN  
99-076 5/10 5907558465006

## Lampa warsztatowa

Workshop lamp / Werkstattlampe / Лампа переносная / Лампа переносна / Stekklampe / Lampă atelier / Dilenská lampa / Dielenská lampa / Delavniška svetilka / Lampa dirbtuvėms / Pārnēsājāmā lampa / Тоокоја лампа / Лампа работна / Radna lampa / Radna lampa / Λάμπα εργαστηρίου / Lámpara de taller / Lampada da officina / Lámpada de oficina / Lampe d'établi / Werkplaatlamp

**TOPEX**



Ref. EAN  
94W245 15/60 5902062942456

## Lampa z czujnikiem ruchu

Lamp with motion sensor / Лампа с датчиком движения / Lampă cu senzor de mișcare / Лампа тозгасэрэкелөвөл / Лампа з датчиком руху / Svetidlo so snímačom pohybu / Lampa se snimačom pohybu / Lampe mit Bewegungssensor / Svetilka s senzorjem gibanja / Lampa su judesio jutikliu / Lampa ar kustības sensoru / Liikumisanduriga lamp / Лампа със сензор за движение / Svjetiljka sa senzorom pokreta / Лампа са сензором покрета / Λάμπα με αισθητήρα κίνησης / Lámpara con sensor de movimiento / Lampada con sensore di movimento / Lámpada com sensor de movimento / Lampe avec détecteur de mouvement / Lamp met bewegingssensor

**NEO**  
TOOLS



Ref. P [W] [lm] EAN  
99-094 10 800 0/60 5907558469554  
99-049 30 2400 0/20 5907558452464  
99-050 50 5000 0/10 5907558452471





# Lampa

Lamp / Lampe / Лампа / Лампа / Lámpa / Lampă / Lampa / Lampa / Svetilka / Lampa / Lampa / Lamp / Лампа / Lampa / Lampa / Lámpa / Lampada / Lâmpada / Lampe / Lamp /

**NEO**  
TOOLS

<b>SMD LED</b>	<b>50W</b> 4500 max lm	<b>230V</b> 50Hz	<b>CABLE</b> 2m EU plug	<b>BEAM ANGLE</b> >120°	<b>6500 K</b>	<b>25000h</b> work time
<b>&lt;1.0s</b>	<b>ON/OFF</b> ≥15000	<b>CRI</b> Ra≥80	<b>PF&gt;0.9</b>	<b>-25°&lt;</b> <b>&gt;45°</b>	<b>NO DIMM</b>	<b>IP65</b>

**NEO**  
TOOLS

<b>SMD LED</b>	<b>230V</b> 50Hz	<b>30000h</b> work time	<b>6500 K</b>	<b>ALUMINIUM BODY</b>	<b>IP65</b>	<b>BEAM ANGLE</b> >100°
<b>CRI</b> Ra≥70	<b>&lt;0.5s</b>	<b>ON/OFF</b> ≥15000	<b>CABLE</b> 15cm	<b>NO DIMM</b>	<b>-40°&lt;</b> <b>&gt;50°</b>	<b>PF&gt;0.8</b>



Ref.	P [W]	[lm]	☒	EAN
99-063	50	4500	0/10	5907558452600



Ref.	P [W]	[lm]	☒	EAN
99-093	10	800	0/60	5907558469547
99-051	20	1600	0/40	5907558452488
99-052	30	2400	0/30	5907558452495
99-053	50	4000	0/20	5907558452501
99-054	100	8000	0/10	5907558452518



# Lampa

Lamp / Lampe / Лампа / Лампа / Lámpa / Lampă / Lampa / Lampa / Svetilka / Lempa / Lampa / Lamp / Лампа / Lampa / Lampa / Lámpa / Lámpara / Lampada / Lámpada / Lampe / Lamp

**NEO**  
TOOLS

100W	230V	SMD LED	6500 K	BEAM ANGLE >110°	-25° < >45°	ON/OFF ≥15000
8500 lm	50Hz					
25000h work time	CRI Ra ≥ 80	60% <1s	max 1.8m	NO DIMM	CABLE 3m	DF>0.9 IP65



Ref.	P [W]	[lm]	☒	EAN
99-095	100	8500	0/2	5907558469561

**NEO**  
TOOLS

SMD LED	H 1.8 m MAX	6500 K	25000h work time
230V 50Hz	BEAM ANGLE >120°	60% <1.0s	PF>0.9
CRI Ra ≥ 80	CABLE 3m EU plug	NO DIMM	-25° < >45°
ON/OFF ≥15000	IP65		



Ref.	P [W]	[lm]	☒	EAN
99-059	30	2700	0/4	5907558452563
99-060	50	4500	0/4	5907558452570

**NEO**  
TOOLS

2x100W	230V	SMD LED	6500 K	ON/OFF ≥15000	25000h work time
16400 lm	50Hz				
BEAM ANGLE >110°	-25° < >45°	CRI Ra ≥ 80	max 1.8m	CABLE 3m	60% <1s
NO DIMM	DF>0.9	ON/OFF switch	IP65		



Ref.	P [W]	[lm]	☒	EAN
99-096	200	8500	0/2	5907558469578

**NEO**  
TOOLS

230V 50Hz	SMD LED	H 1.8 m MAX	BEAM ANGLE >120°
6500 K	25000h work time	60% <1.0s	PF>0.9
-25° < >45°	NO DIMM	CRI Ra ≥ 80	CABLE 3m EU plug
ON/OFF ≥15000	IP65		



Ref.	P [W]	[lm]	☒	EAN
99-061	2x 30	5400	0/4	5907558452587
99-062	2x 50	9000	0/4	5907558452594



## Lampa fasadowa

Exterior wall lamp / Fassadenleuchte / Фасадный светильник / Фасадний світильник / Kültéri lámpa / Lampă de fațadă / Fasádní lampa / Fasádne svietidlo / Fasadna svetilka / Fasadinis šviestuvas / Fasádes lampa / Fassaadilamp / Фасадна лампа / Fasadna lampa / Fasadna lampa / Φαλακτικό πρόσφυσης / Lámpara de fachada / Lampada per facciate / Candeeiro de fachada / Lampe de façade / Gevellamp

**NEO**  
TOOLS



MAX  
15W  
LED

220 -  
240V  
50hz

STAINLESS  
STEEL

LIGHTBULB  
E27  
NOT INCLUDED

IP44

Ref.	H (mm)	☒	EAN
99-080	500	0/4	5907558465778
99-081	800	0/4	5907558465785



## Lampa fasadowa

Exterior wall lamp / Fassadenleuchte / Фасадный светильник / Фасадний світильник / Kültéri lámpa / Lampă de fațadă / Fasádní lampa / Fasádne svietidlo / Fasadna svetilka / Fasadinis šviestuvas / Fasádes lampa / Fassaadilamp / Фасадна лампа / Fasadna lampa / Fasadna lampa / Φαλακτικό πρόσφυσης / Lámpara de fachada / Lampada per facciate / Candeeiro de fachada / Lampe de façade / Gevellamp

**NEO**  
TOOLS

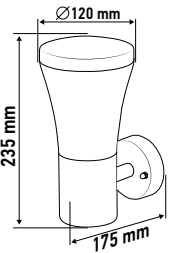

MAX  
15W  
LED

220 -  
240V  
50hz

STAINLESS  
STEEL

IP44

LIGHTBULB  
E27  
NOT INCLUDED

Ref.	☒	EAN
99-079	0/6	5907558465761

**NEO**  
TOOLS



LIGHTBULB  
G40  
NOT INCLUDED

LIGHTBULB  
2x G40  
NOT INCLUDED

MAX  
35W

220 -  
240V  
50hz

STAINLESS  
STEEL

IP44

LIGHTBULB  
NOT INCLUDED

Ref.	☒	EAN
99-082	0/24	5907558465792
99-083	0/24	5907558465808



## Lampa solarna

Solar lamp / Солнечная лампа / Lampă solară / Napelemes lámpa / Сонячна лампа / Solárna lampa / Solární lampa / Solarlampe / Solárna lampa / Saules lampa / Saules lampa / Pāikeselamp / Слънчева лампа / Solarna lampa / Соларна лампа / Ηλιακό λαμπτήρας / Lámpara solar / Lampada solare / Luminária solar / Lampe solaire / Zonne-lamp

**NEO**  
TOOLS



SOLAR  
POWER  
2V/160mA

SMD  
LED

10lm

1.2V  
600mAh  
Ni-MH AA

CHARGING  
TIME  
6-8h

WORKING  
TIME  
8-10h

MATERIALS:  
STAINLESS  
STEEL  
+  
GLASS

IP44



Ref.	☒	EAN
99-084	0/32	5907558465815

**NEO**  
TOOLS



SOLAR  
POWER

LED

180lm

3.7V  
2200mAh  
Li-Ion

CHARGING  
TIME  
6-8h

WORKING  
TIME  
6-8h

PP  
MATERIAL

IP44



Ref.	☒	EAN
99-085	0/24	5907558465822

**NEO**  
TOOLS



SOLAR  
POWER

LED

20lm

OFF  
ON

1.2V  
700mAh  
Ni-MH AA

CHARGING  
TIME  
6-8h

WORKING  
TIME  
8h

MATERIALS:  
ALUMINUM  
+  
PL

IP65



Ref.	☒	EAN
99-086	0/32	5907558465839

**NEO**  
TOOLS



SOLAR  
POWER  
2V/160mA

LED

50lm

OFF  
ON

1.2V  
600mAh  
Ni-MH AA

CHARGING  
TIME  
6-8h

WORKING  
TIME  
8-10h

MATERIALS:  
PLASTIC  
+  
STAINLESS  
STEEL

IP65



Ref.	☒	EAN
99-087	0/100	5907558465846



## Lampa solarna

Solar lamp / Солнечная лампа / Lampă solară / Napelemes lámpa / Соляная лампа / Solárna lamp / Solárni lamp / Solarlampe / Solárna lamp / Saulės lempa / Saules lamp / Päikeselamp / Стънчева лампа / Solarna lamp / Соларна лампа / Ηλεκός λαμπτήρας / Lámpara solar / Lampada solare / Luminária solar / Lampe solaire / Zonne-lamp

**NEO**  
TOOLS



Ref. EAN  
99-088 0/60 5907558465853

**NEO**  
TOOLS



Ref. EAN  
99-090 0/40 5907558465877

**NEO**  
TOOLS



Ref. EAN  
99-055 0/50 5907558452525

**NEO**  
TOOLS



Ref. EAN  
99-091 0/20 5907558465884

**NEO**  
TOOLS



Ref. EAN  
99-089 0/8 5907558465860

**NEO**  
TOOLS



Ref. EAN  
99-057 0/30 5907558452549

**NEO**  
TOOLS



Ref. EAN  
99-092 0/20 5907558469530

**NEO**  
TOOLS

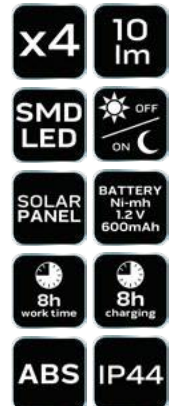

Ref. EAN  
99-058 0/16 5907558452556





# SURVIVAL

## Zestaw survivalowy

Survival kit / Überlebensausrüstung / Набор для выживания / Набор для выживания / Túléló készlet / Kit de supervieiture / Sada pro přežití / Súprava na prežitie / Komplet za preživetje / Išgyvenimo rinkinys / Izdzižošanas komplekts / Ellujäämiskomplekt / Комплект за оцеляване / Komplet za preživljavanje / Комплект за преживљавање / Κοιτί επιβίωσης / Equipo de supervivencia / Il corredo di sopravvivenza / O estojo de sobrevivência / L' équipement de survie / Overlevingspakket

**NEO**  
TOOLS



14in1



2x hooks  
flint  
compass  
folding knife  
survival bracelet  
whistle  
wiresaw  
tactical pen  
kettle buckle  
flashlight  
3W  
1.5 V, XPE  
battery 1xAAA  
multi-functional card  
LED keychain  
mini-light 3V  
battery  
1x CR2032



Ref. 63-153  
EAN 5907558482607

**NEO**  
TOOLS



8in1



Ref. 63-154  
EAN 5907558482041



## Bransoletka survivalowa

Survival bracelet / Überlebensarmband / Браслет выживания из паракорда / Браслет выживания / Túlélő karkötő / Brățară de supraviețuire / Outdoor náramek – survival / Náramek na prežitie / Zapestnica za preživetje / Išgyvenimo apyrankė / Izdzīvošanas aproce / Ellujäämise käevõru / Гръвна за оцеляване / Наруквица за преživljavanje / Наруквица за преživljavanje / Βραχιόλι επιβίωσης / Pulseira de supervivência / Braccialetto di sopravvivenza / Pulseira de sobrevivência / Bracelet de survie / Survival armband

**NEO**  
TOOLS

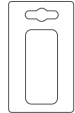

**5in1**  
• paracord rope  
• flint  
• compass  
• knife  
• whistle

**PARACORD**

**FLINT**

Ref. 63-140    6/48    EAN 5907558454222

## Narzędzie wielofunkcyjne

Multipurpose tool / Allzweckwerkzeuge / Инструмент универсальный / Инструмент багатофункційний / Multiszerszám / Unealta multifunctionala / Multifunkční nástroj / Viacfunkčné náradie / Večfunkcijsko orodje / Daugiafunkciniai įrankiai / Daudzfunkcionālie instrumenti / Multifunktsionaalne tööriist / Мультифункционален инструмент / Višenamjenski uređaj / Višefunkcionalne alatke / Πολυεργαλείο / Herramienta multiuso / Utensile multiuso / Aparelho multifunções / Outil multifonction / Multifunctioneel gereedschap

**NEO**  
TOOLS

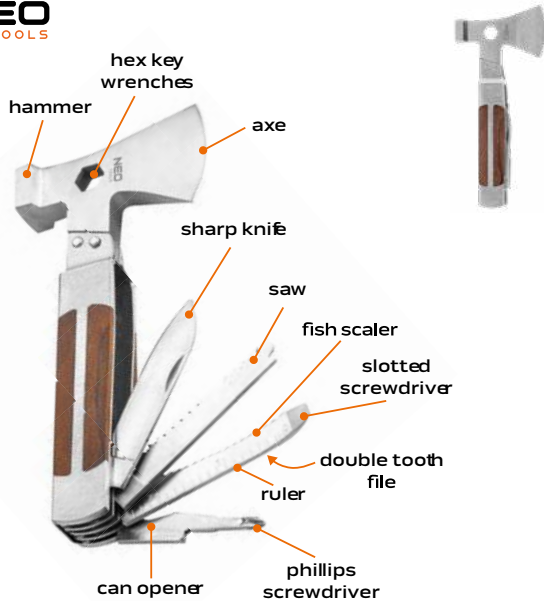

**11in1**

**STAINLESS steel**

**+**

Ref. 63-112    6/24    EAN 5907558453591

**NEO**  
TOOLS

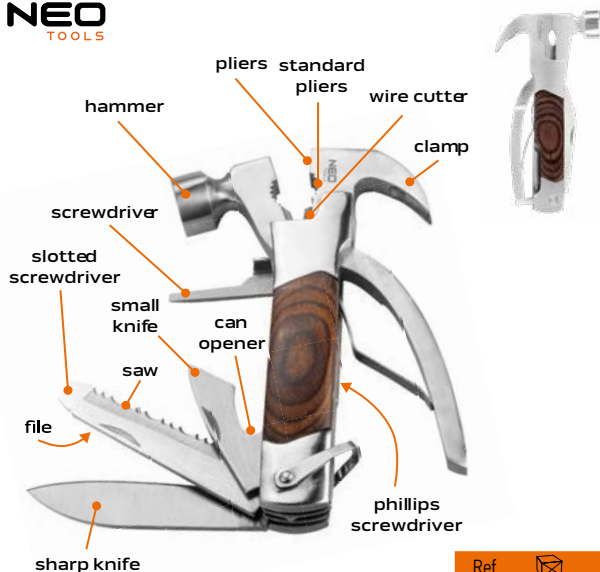

**13in1**

**STAINLESS steel**

**+**

Ref. 63-113    6/48    EAN 5907558453607

## Narzędzie wielofunkcyjne

Multipurpose tool / Allzweckwerkzeuge / Инструмент универсальный / Инструмент багатофункційний / Multiszerszám / Unealta multifunctionala / Multifunkční nástroj / Viacfunkčné náradie / Večfunkcijsko orodje / Daugiafunkciniai įrankiai / Daudzfunkcionālie instrumenti / Multifunktsionaalne tööriist / Мультифункционален инструмент / Višenamjenski uređaj / Višefunkcionalne alatke / Πολυεργαλείο / Herramienta multiuso / Utensile multiuso / Aparelho multifunções / Outil multifonction / Multifunctioneel gereedschap

**NEO**  
TOOLS

**LED light**

**ALUMINIUM BODY**

**10 in 1**

**+**



Ref. 01-027    W [mm] 105    6/48    EAN 5907558420944

**NEO**  
TOOLS

**LED light**

**ALUMINIUM BODY**

**12 in 1**

**+**



Ref. 01-026    W [mm] 155    6/36    EAN 5907558420937

**NEO**  
TOOLS



Ref. 01-028    W [mm] 150    6/36    EAN 5907558420951

**ALUMINIUM BODY**

**11 in 1**

**STOP**

**+**



# Nóż

Knife / Messer / Нож / Hibx / Kés / Cuçit / Nůž / Nôž / Nož / Peilis / Nazis / Nuga / Макемен нож / Noz / Μαχαίρι / Coltello / Faca / Couteau / Mes

**NEO**  
TOOLS

**215 mm** STAINLESS steel PP+TPR HANDLE + 

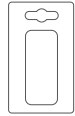

Ref.  EAN  
63-105 6/24 5907558453522

**NEO**  
TOOLS

**FULL TANG** **165 mm** STAINLESS steel TPR HANDLE + 

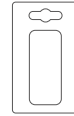

Ref.  EAN  
63-106 6/48 5907558453539

**NEO**  
TOOLS

**220 mm**  **BLADE 9cm** **420 STAINLESS steel** **6in1**  
 •K nife  
 •W histle  
 •Fire starter  
 •Wrench  
 •S afe bet cutter  
 •G lass breaker

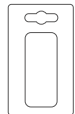

Ref.  EAN  
63-107 12/72 5907558453546

**NEO**  
TOOLS

**FULL TANG** **250 mm** STAINLESS steel BAMBOO HANDLE +  **TITANIUM FINISH**

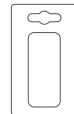

Ref.  EAN  
63-110 6/24 5907558453577

## Nóż składany

Folding knife / Messer zusammenklappbar / Нож складной / Hibx складной / Űsszecsukható tőr / Briceag pliabil / Skládací nůž / Skladací nůž / Zložljiv nož / Sulankstomas peilis / Saliekamais nazis / Kokkukäiv nuga / Нож сзъвам / Sklopiv nož / Nož na sklapanje / Μαχαίρι πλισσάμενο / Cuchillo plegable / Coltello a serramanico / Faca dobrável / Couteau pliable / Vouwmes

**NEO**  
TOOLS

**BALL BEARING ASSISTED OPENING** **180 mm** **BLADE 8cm** **440SS STAINLESS steel**

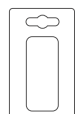

Ref.  EAN  
63-114 12/72 5907558453614

**NEO**  
TOOLS

**220 mm** STAINLESS steel **SS+ ROSEWOOD HANDLE**  **TITANIUM FINISH**

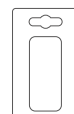

Ref.  EAN  
63-115 6/24 5907558453621

**NEO**  
TOOLS

**440 steel blade** **TITANIUM BODY**  + 



Ref.  EAN  
63-025 6/48 5907558420968

**NEO**  
TOOLS

**440 steel blade** **ANODIZED ALUMINIUM BODY**   **BELT CUTTER**

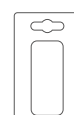

Ref.  EAN  
63-026 6/48 5907558420975





## Nóż uniwersalny

Knife / Universalmesser / Нож универсальный / Нож / Trapézpengés összecsatolható kés / Cuțit / Универзълни нъж / Nôž univerzálny / Nož / Universatus peilis / Nazis / Nuga / Ножче / Džepni nožić / Nož / Μαχαίρι γενικής χρήσης / Cuchillo universal / Taglierino a lama fissa / Faca universal / Couteau universel / Universele mes

NEO  
TOOLS

FULL TANG BLADE 12cm 230 mm 420 STAINLESS steel +

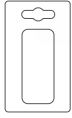

Ref. 63-111 EAN 12/48 5907558453584

NEO  
TOOLS

FULL TANG 240 mm STAINLESS steel PAKKA WOOD HANDLE + TITANIUM FINISH BOTTLE OPENER

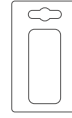

Ref. 63-116 EAN 6/24 5907558453638

NEO  
TOOLS

FULL TANG 220 mm STAINLESS steel ABS HANDLE +

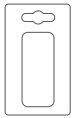

Ref. 63-108 EAN 6/24 5907558453553

NEO  
TOOLS

FULL TANG 2in1 BLADE 9cm FLINT 420 STAINLESS steel +

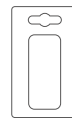

Ref. 63-109 EAN 12/48 5907558453560

## Nóż z ostrzem stałym

Retractable blade knife / Messer m. Festklinge / Нож со сплошным лезвием / Нож з висувним лезом / Pvc kés / Cuțit lamă mobilă / Nůž se stabilním ostřím / Nožik / Nož / Peilis su nulaužiama geležte / Nazis ar trapezveida asmeni / Sisseðömmatava teraga nuga / Манжетен нож / Skalpel / Skalpel / Πτυσσόμενος σουγιάς / Cuchillo de hoja retráctil / Coltello con lama fissa / Faca com lâminam permanente / Couteau à lame fixe

LIMITED EDITION 110 mm BLADE STAINLESS steel PARACORD +

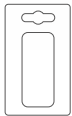

Ref. 63-100 EAN 5907558450835

## Scyzoryk biwakowy

Camping knife / Taschenmesser / Нож перочный туристический / Нож туристичний багатofункційний / Zsebkés / Briceag camping / Kapesní nůž pro kempování / Vreckový nožik turistický / Žepni nož za kempiranje / Kišeninis peiliukas, stovyklautojui / Saliekamais tūrista nazis / Matka-taskunuga / туристическо джовно ножче / Švicarski džepni nož / Nož za kempovanje / Πολυεργαλείο τουριστικό / Navaja suiza de acampada / Coltellino multiuso / Canivete de bivaque / Couteau bivouac / Bivak zakmes

NEO  
TOOLS

ALUMINIUM BODY 2 parts +

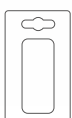

Ref. 63-027 EAN 6/48 5907558420982

## Maczeta

Machete / Machete / Мачете / Мачете / Machete / Machete / Mačeta / Mačeta / Mačeta / Machete / Mačete / Machete / Мачете / Маčета / Мачета / Μεγάλη / μαχαίρα / Machete / Machete / Machete / Machete / Machete

NEO  
TOOLS

40 cm STAINLESS steel DOUBLE COMPONENT HANDLE

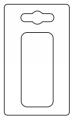

Ref. 63-117 EAN 6/24 5907558453997

## Piła ręczna bushcraftowa

Bushcraft hand saw / Säge Hand Bushcraft / Ручная пила для бущкрафта / Ручна пила для бущкрафта / Bushcraft kézfűrés / Ferästräu de mänä bushcraft / Viadël ručni bushcraft / Bushcraftová ručná píla / Sierra manual bushcraft / Seghetto manuale da bushcraft / Scie à main bushcraft

NEO  
TOOLS

21 cm FOLDING CONSTRUCTION SK4 HRC 66 TRIPLE GROUND TEETH

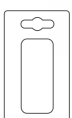

Ref. 63-120 EAN 12/72 5907558454024



## Siekiera

Axe / Axt / Topor / Сокира / Balta / Topor / Sekera / Sekera / Sekira / Kirvis / Cirvis / Kirves / Брахда / Sjekira / Sekira / Τσεκούρι / Hacha / Scure / Machado / Hache / Bijl

NEO  
TOOLS

26  
cm

STAINLESS  
steel

PARACORD  
HANDLE

WRIST  
STRAP

TITANIUM  
FINISH

WRENCH  
10 / 13 / 16  
mm



Ref. 63-118    EAN 5907558454000

## Saperka składana

Folding army shovel / Klappschaufel / Лопата саперная складная / Лопата саперна складна / Összehajtható gyalogsági ásó / Lopatá pliable / Skládací lopata / Lopata krátka skladaná / Pala plegable / Pala militare pieghevole / Pelle pliante

NEO  
TOOLS



6in1

• shovel  
• pickaxe  
• bottle  
opener  
• saw  
• wrench

FOLDING  
CONSTRUCTION

10mm  
SCREW



Ref. 63-121    EAN 5907558454031

## Plecak taktyczny

Tactical backpack / Taktischer Rucksack / Тактический рюкзак / Тактичний рюкзак / Szerszámos hátizsák / Rucsac tactic / Taktický batoh / Taktický batoh / Taktični nahrbtnik / Taktične kupriné / Taktická mugursoma / Taktikaline seljakott / Такмическа раница / Taktički ruksak / Такмички раница / Тактико σακίδιο πλάτης / Mochila táctica / Zaino tattico / Mochila táctica / Sac à dos tactique / Tactische rugzak

NEO  
TOOLS

HEAVY  
DUTY

15  
kg

600D



18 kieszeni wewnętrznych  
18 inside pockets  
18 внутрішні кишені



4 kieszenie zewnętrzne  
4 outer pockets  
4 зовнішні кишені



Ref. 84-321    EAN 5907558444155

## Toporek bushcraftowy w futerale

Bushcraft hatchet with sheath / Axt Bushcraft in einem Fall / Topor для бушкрафта в чехле / Сокира для бушкрафта в чохлах / Bushcraft fejsze tokban / Topor bushcraft în husă / Axe Bushcraft v pouzde / Bushcraftová sekerka v puzdre / Bushcraft hacha en un estuche / Assetta da Bushcraft in custodia / Hache bushcraft dans un étui

NEO  
TOOLS

400  
g

WOODEN  
HANDLE

LEATHER  
POUCH

C55  
STEEL



Ref. 63-119    EAN 5907558454017

## Saperka multifunkcyjna

Multifunctional shovel / Klappschaufel / Многофункциональная лопата / Лопата саперна складна / Összehajtható gyalogsági ásó / Lopatá pliable / Skládací lopata / Lopata krátka skladaná / Pala plegable / Pala militare pieghevole / Pelle pliante

NEO  
TOOLS



8in1

• shovel  
• saw  
• pickaxe  
• bottle  
opener  
• file  
• multifunction  
knife  
• safety  
hammer  
• whistle

FOLDING  
CONSTRUCTION

MAX  
LENGTH  
63cm



Ref. 63-122    EAN 5907558454048

## Torba turystyczna

Tourist bag / Touristentasche / Туристическая сумка / Туристична сумка / Turista táska / Geantă turistică / Turistická taška / Turistická taška / Turistična torba / Turistinis krepšys / Turistu soma / Turistikott / Туристическа чанта / Turistička torba / Туристичка торба / Τουριστική τσάντα / Bolsa de turista / Borsa turistica / Mala de turista / Sac touristique / Toeristentas

NEO  
TOOLS

HEAVY  
DUTY

600D

40x22  
x  
33 cm



8 kieszeni wewnętrznych  
8 inside pockets  
8 внутрішні кишені



14 kieszeni zewnętrznych  
14 outer pockets  
14 зовнішні кишені



Ref. 84-322    EAN 5907558444186



## Torba turystyczna

Tourist bag / Touristentasche / Туристическая сумка / Туристична сумка / Turista táska / Geantă turistică / Turistická taška / Turistická taška / Turistična torba / Turistinis krepšys / Turistu soma / Turistkott / Туристическа чанта / Turistička torba / Туристична торба / Туристичкі таўна / Bolsa de turista / Borsa turistica / Mala de turista / Sac touristique / Toeristentas

NEO  
TOOLS

HEAVY  
DUTY



4 kieszenie zewnętrzne  
4 zip fastened outer pockets  
4 наружных кармана



4 kieszenie wewnętrzne  
4 inside pockets  
4 внутренних кармана



Ref. 84-323  
0/35  
EAN 5907558444179

## Saszetka

Waist bag / Gürteltasche / Поясная сумка / Торба на паску / Ersény / Borseta / Ledvinka / Ladvinka / Pasma torbica / Deklas / Jostas soma / Vöökott / Папаска / Pasma torbica / Torbica / Τσαντάκι μέσης / Riñonera / Marsupio / Bolsa / Sacoche porte-outils à ceinture

NEO  
TOOLS

HEAVY  
DUTY



2 pojemne komory główne  
Two capacious main compartments  
2 удобных главных отдела



3 kieszenie wewnętrzne  
3 inside pockets  
3 внутренних кармана



Ref. 84-324  
0/70  
EAN 5907558444162

## Plecak turystyczny

Outdoor backpack / Reiserucksack / Туристический рюкзак / Туристичний рюкзак / Turista hátizsák / Rucsac turistic / Cestovní batoh / Náramok na prežitie / Zaino turistico

NEO  
TOOLS

30L

15  
kg

600D

HEAVY  
DUTY



Ref. 84-325  
0/8  
EAN 5907558455311

## Plecak survivalowy

Survival backpack / Überlebensrucksack / Рюкзак для выживания / Рюкзак для виживання / Tútlélő hátizsák / Rucsac survival / Batoh na přežití / Náramok na prežitie / Zaino da sopravvivenza

NEO  
TOOLS

40L

20  
kg

600D

4in1



Ref. 84-326  
0/12  
EAN 5907558455328

## Plecak wodoodporny

Water-proof backpack / Wasserdichter Rucksack / Водонепроницаемый рюкзак / Водонепроникний рюкзак / Vízálló hátizsák / Rucsac impermeabil / Vodotěsný batoh / Vodovzdorný batoh / Mochila impermeable / Zaino impermeabile / Sac à dos étanche

NEO  
TOOLS

30L

WATER  
PROOF

32  
63  
x  
18 cm

600D  
PVC



Ref. 63-131  
0/6  
EAN 5907558454130



## Palnik gazowy turystyczny

Camping gas burner / Touristischer Gasbrenner / Газовая горелка туристическая / Газовий пальник туристичний / Turista gázégő / Arzător pe gaz turistic / Turistický plynový hořák / Turistický plynový horák / Quemador de gas turístico / Bruciatore a gas turistico / Brûleur à gaz touristique

NEO  
TOOLS



nozzle type EN 417	STAINLESS steel
3000 W	140 g/h
103g	123 x80 mm
MAX CAPACITY 5kg	MAX DIA 20cm

Ref.	palnik/valve	📦	EAN
63-128	7/16	0/50	5907558454109

## Kuchenka gazowa

Gas cooker / Gasherd / Газовая плита / Газова плитка / Gázfőző / Aragaz / Plynový sporák / Plynový varič / Plinski štedilnik / Dujų viryklė / Gāzes plīts / Gaasipliit / Газова печка / Plinsko kuhalo / Шпорет на плин / Koučína aeríou / Fornello a gas / Estufa de gas / Fogão a gás / Réchaud à gaz / Gasformuis

NEO  
TOOLS



2.1 kW	PIEZO
150 g/h	+ GAS
nozzle type EN 417	LOCK

Ref.	📦	EAN
20-050	0/6	5907558465372

## Oslona przeciwwiatrowa palnika

Burner torch wind guard / Brennerwindabweiser / Ветрозащита для горелки / Вітрозахист для пальника / Égő szélvédő / Deflector de vânt al arzătorului / Kryt proti větru hořáku / Protivetrový štít horáka / Zaščita pred vetrom gorilnika / Degiklio degiklio vějo arsauga / Degļa lāpas vēja aizsargs / Pōleti pōleti tuulekaitse / Ветрозащитна заштита на горелката / Štitnik od vjetra plamenika / Штитник од ветра горионика / Προστατευτικό πυροσφαιριστήρα / Protector contra el viento de la antorcha del quemador / Protezione antivento torcia bruciatore

NEO  
TOOLS



OUTDOOR NEO	10 PIECES
+ TRAVEL CASE	277 g
	ALUMINIUM

Ref.	📦	EAN
63-142	0/40	5907558467239

## Podstawka pod kartusz

Cartridge storage base / Kartuschenständer / Подставка для картуши / Підставка для картуши / Gázpalack talp / Suport pentru cartuş / Podložka pod kartuši / Podstavec na kartuše / Podstavek za kartušo / Kartušo stovas / Tvertnes paliktnis / Gaasiballooni alus / Стойка за картушу / Temelj za kartuš / Osnov za kartuš / Στανι κάρτους / Base para cartucho / Base per cartiglio / Suporte de cartucho / Porte-cartouches / Patron standaard

NEO  
TOOLS



FOLDABLE	PC MATERIAL
	30 g

Ref.	📦	EAN
63-143	0/120	5907558467246

## Kuchenka survivalowa

Survival stove / Überlebenskocher / Плита для выживания / Плита для виживання / Túléló főző / Aragaz survival / Sporák na přežití / Survival varič / Cocina de supervivencia / Fornello da sopravvivenza / Cuiseur de survie

NEO  
TOOLS



FOLDING CONSTRUCTION
STAINLESS steel
369g
16 cm
+ 📦

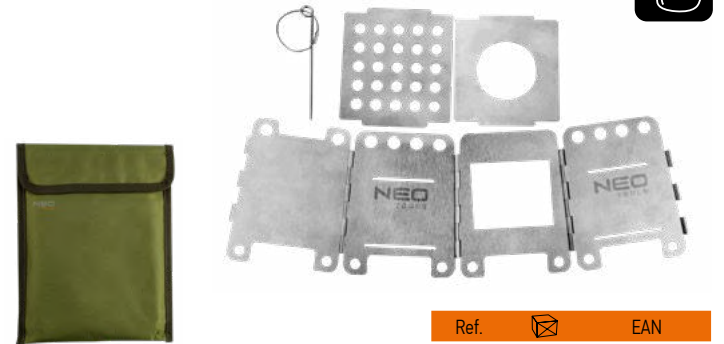

Ref.	📦	EAN
63-126	0/20	5907558454086

## Kuchenka turystyczna garnek + palnik

Cooking pot stove + burner / Kochtopf Herd + Brenner / Плита - горшок + горелка / Варочна плита + конфорка / Fazék tűzhely + égő / Oala de gatit aragaz + arzator / Varný hrniec + hořák / Varný hrniec + horák / Lončna peč + gorilnik / Puodo viryklė + degiklis / Gatavošanas katla plīts + deglis / Keedupliit + pōleti / Печка за готвене + горелка / Lonac za kuhanje + plamenik / Шпорет за кување + горионик / Μαγειρική εστία + καυστήρας / Cocina olla estufa + quemador / Pentola fornello + fornello / Fogão + queimador / Poêle à marmite + brûleur / Kookpot fornuis + brander

NEO  
TOOLS



OUTDOOR NEO	3in1	510 g
POT 1L ø128mm x 173mm	RADIATOR +30% POWER	nozzle type EN 417
PIEZO	2.2 kW	158 g/h
ANODIZED ALUMINIUM	INSULATED HANDLES	FOLDING HANDLES
NEOPRENE COVER	TRAVEL BAG INCLUDED	400ml CUP

Ref.	📦	EAN
63-151	0/24	5907558469509

## Kubek turystyczny

Camping mug / Reisebecher / Туристическая кружка / Туристична кружка / Kemping bögre / Cană de turism / Cestovní hrnek / Turistická kanvica / Skodelica za kampiranje / Kelioninis puodelis / Ceļojumu krūze / Matkakruus / Туристическа чаша / Turistička šalica / Turistička šolja / Κούπα ταξιδιού / Taza de viaje / Bicchiere turistico / Caneca de viagem / Gobelet touristique / Reisbeker

NEO  
TOOLS



150 g	FOLDABLE HANDLE
DOUBLE WALL	320ml ø80mm x 92mm
STAINLESS STEEL	TRAVEL BAG INCLUDED

Ref.	📦	EAN
63-150	0/100	5907558467314



## Zestaw garnków 2 w 1 z radiatorem

2-in-1 set of heat sink pots / 2-in-1-Kochgeschirrsset mit Wärmespeicher / Набор кастрюль 2 в 1 с радиатором / Набор кастрюль 2 в 1 з радіатором / Edénykészlet hőcsérelővel 2 az 1-ben / Set de vase de gătit 2 în 1 cu radiator / Sada hrnců 2v1 s chladičem / Súprava hrncov 2 v 1 s teplovodným prvkom / Komplet loncev 2v1 z grelnikom / Posađy rínkínys du viename su radiatoriumi / Katlu komplekts ar radiatoru divi dieni / Pottide komplekt 2in1 radiatoriga / Комплект кухоненки съдове 2 в 1 с радиатор / Set lonaca 2 u 1 s radiatorom / Set Šerpi 2 u 1 sa radijatorom / Σετ 2 σε 1 κασαρόλες με ψύκτρα / Juego de ollas 2 en 1 con radiador / Set di pentole 2 in 1 con radiatore / Conjunto de panelas 2 em 1 com dissipador de calor / Kit de casseroles 2 en 1 avec dissipateur de chaleur / 2-in-1 pannenset met radiator

NEO TOOLS



Ref. 63-144    EAN 0/24 5907558467253

## Zestaw turystyczny

Camping cooking set / Reiseset / Туристический набор / Туристичний набір / Camping készlet / Set de turism / Cestovní sada / Turistická súprava / Komplet za kampiranje / Kelioninis rinkinys / Tūrisma komplekts / Matkakomplekt / Туристически комплект / Turistički set / Turistički set / Τουριστικό κιτ / Juego de viaje / Set turistico / Kit de viagem / Kit touristique / Reisset

NEO TOOLS



Ref. 63-145    EAN 0/24 5907558467260

NEO TOOLS



Ref. 63-146    EAN 0/24 5907558467277

## Czajnik turystyczny

Camping kettle / Reise-Wasserkocher / Туристический чайник / Туристичний чайник / Camping vízfornaló / Ceainic de turism / Cestovní konvice / Turistická kanvica / Grelnik za vodo za kampiranje / Kelioninis virdulys / Tūristu tējkanna / Matka-teekann / Туристически чайник / Turistički čajnik / Turistički čajnik / Βραστήρας ταξιδιού / Hervirder de agua de viaje / Bollitore turistico / Chaleira de viagem / Bouilloire touristique / Reis waterkoker

NEO TOOLS



Ref. 63-147    EAN 0/24 5907558467284

## Sztuíce turystyczne

Camping cutlery set / Reisebesteck / Туристические столовые приборы / Туристични столови прилади / Kemping evőeszköz-készlet / Tacámuri de turism / Cestovní přístroje / Turistický príbor / Jedilni pribor za kampiranje / Kelioniniai stalo įrankiniai / Tūrisma galda piederumi / Matka-sőőriřistad / Туристическу прибору / Turistički escaj / Turistički escaj / Ταξιδιωτικά μαχαροπήριουα / Cubiertos de viaje / Set di utensili turistici / Talheres de viagem / Ustensiles touristiques / Reisbestek

NEO TOOLS



Ref. 63-148    EAN 0/80 5907558467291

## Lodówka turystyczna

Refrigerator / Kühlschrank / Холодильник / Холодильник / Hűtőszekrény / Frigider / Lednička / Chladnička / Hladník / Šaldytvas / Ledusskapis / Külmkapp / Хладилник / Hladnjak / Фрижидер / Ψυγείο / Refrigerador / Frigorifero / Frigorífico / Réfrigérateur / Koelkast

NEO TOOLS



Ref. 63-152    EAN 0/2 5907558469516

## Materac turystyczny

Camping mattress / Reismatratze / Туристический матрас / Туристичний матрац / Camping matrac / Saltea de turism / Cestovní matrace / Turistický matrac / Blazina za kampiranje / Kelioninis čiužinys / Tūrisma matracis / Matkamadrats / Туристически матрак / Turistički madrac / Turistički dušek / Τουριστικό στρώμα / Colchón de viaje / Materasso turistico / Colchão de viagem / Matelas touristique / Reismatras

NEO TOOLS



Ref. 63-149    EAN 0/20 5907558467307

## Lina paracord

Paracord rope / Paracord Seil / Παρακόρδ / Канат Paracord / Paracord kötél / Frānghie Paracord / Paracordové lano / Paracordové lano / Cuerda de paracord / Corda Paracord / Corde Paracord

NEO TOOLS



Ref. 63-125    capacity [kg] 400    EAN 20/100 5907558454079



## Taśmy do hamaków

Hammock webbing / Hängemattenbänder / Ленты для гамаков / Стрічки для гамаків / Szalagok függőágyhoz / Benzi pentru hamace / Houpací pásky / Popruhy na hamak / Cintás para hamacas / Nastroj per amache / Rubans hamac

**NEO**  
TOOLS



x2

15  
HOLES

2.5  
m

CAPACITY  
300  
kg

Ref. 63-141    0/50    EAN 5907558454239

## Tarp wodoodporny

Tarp, kit with hooks and cords / Wasserdichte Plane / Тент, комплект + крючки, веревки / Тент, комплект + гачки, мотузки / Poniya, készlet + kampók, kötelek / Prelată adăpost, set + cârtige, frânghii,

**NEO**  
TOOLS



SET  
INCLUDES:  
-1x tarp  
-4x hooks  
-6x ropes  
-2x bags

x6

210T  
POLIESTER

360  
x  
290  
cm

Ref. 63-130    0/15    EAN 5907558454123

## Napinacz linek

Cord tensioner / Seilspanner / Натяжитель троса / Натягувач тросів / Kábelfeszítő / Întinzător de cablu / Napinač lanka / Napinač laniek / Napenjalec vrvi / Virvių įtempiklis / Auklu spriegotājs / Nöörjipingiti / Обтегач за въжета / Zatezač za sajle / Zatezač za sajle / Εντατήρας οχονιών / Tensor de cable / Tendijili / Tensor de cabo / Tendeur de cordes / Lijnspanners

**NEO**  
TOOLS



OUTDOOR  
NEO

x2

FOR  
2.0 - 5.0  
mm  
ROPE

2  
EASY USE  
SYSTEMS

INCLUDED  
ROPE  
Ø 3.7  
mm  
1.5m

Ref. 63-155    0/150    EAN 5907558482058

## Etui wodoodporne na telefon

Waterproof case for the phone / Wasserdichte Hülle für das Telefon / Водонепроницаемый чехол для телефона / Водонепроникний чохол для телефону / Vízálló tok a telefonhoz / Husă pentru telefon rezistentă la apă / Vodotěsné pouzdro na telefon / Vodotěsné puzdro na telefon / Funda impermeable para el teléfono / Custodia impermeabile per il telefono / Boîtier étanche pour le téléphone

**NEO**  
TOOLS



100%  
WATER  
PROOF

PVC  
+  
ABS

6.2" max

CALLING

IPX8

TOUCH

Ref. 63-135    50/200    EAN 5907558454178

## Hamak, zestaw

Hammock kit / Hängematte Set / Гамак, комплект / Гамак, комплект / Fűggőágy, készlet / Hamac, set / Sada houpací síť / Hamak, súprava / Conjunto Hamaca / Amaca, set / Ensemble hamac

**NEO**  
TOOLS



SET  
INCLUDES:  
-1 x hammock  
-1 x bag  
-2 x tapes  
-2 x clip hook

EXTRA  
LONG  
330 x  
140 cm

MAX  
200  
kg

Ref. 63-124    0/20    EAN 5907558454062

## Hamak z moskitierą, zestaw

Bug-screened hammock kit / Hängematte mit Moskitonetz Set / Гамак с москитной сеткой, комплект / Гамак з москитною сіткою, комплект / Rovarháló s függőágy, készlet / Hamac cu plasă antiinsecte, set / Houpací síť s moskytiérou, sada / Hamak so sietkou proti hmyzu, súprava / Conjunto hamaca con mosquitera / Amaca con zanzariera / Ensemble hamac avec moustiquaire

**NEO**  
TOOLS



SET  
INCLUDES:  
-1 x hammock  
+ moskito net  
-1 x bag  
-2 x tapes  
-2 x ropes  
-2 x clip hook

MOSQUITO  
NET

EXTRA  
LONG  
330 x  
140 cm

MAX  
200  
kg

Ref. 63-123    0/20    EAN 5907558454055

## Peleryna przeciwdeszczowa

Rain poncho / Regentmantel / Дождевик / Доцювик / Esőálló körgallér / Pelerină de ploaie / Pláštěnka / Pelerina-pršiplášt / Impermeable / Mantello impermeabile / Imperméable

**NEO**  
TOOLS



3in1  
-p oncho  
-tarp  
-mat

210D  
POLYESTER

CUFF  
BUTTONS

Ref. 63-132    0/20    EAN 5907558454147



## Panel słoneczny przenośny

Portable solar panel / Tragbares Solarpanel / Портативная солнечная панель / Портативна сонячна панель / Hordozható napelem / Panou solar portabil / Přenosný solární panel / Přenosný solárny panel / Prenosna solarna plošča / Nešiojamas saulės kolektorius / Pārnēsājams saules panelis / Kaasaskantav rāikesepaneel / Преносим слънчев панел / Prijenosni solarni panel / Преносни соларни панел / Φορτίο ηλιακό πάνελ / Panel solar portátil / Pannello solare portatile / Draagbaar zonnepaneel / Panneau solaire portatif

**NEO**  
TOOLS



**15W** **2xUSB**  
**BACKPACK CLIP** **CHARGES:** smartphone, laptop, tablet  
**OPEN:** 580x285x15 mm **FOLDED:** 285x200x32 mm  
**IP64**

Ref. m [kg] EAN  
90-140 0,55 1/24 5907558466171

**NEO**  
TOOLS

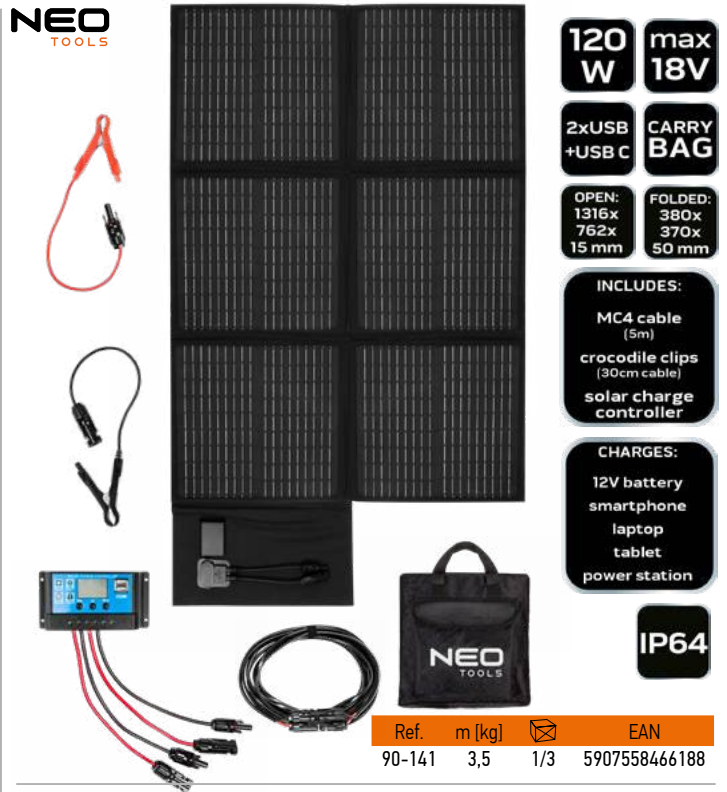

**120W** **max 18V**  
**2xUSB +USB C** **CARRY BAG**  
**OPEN:** 1316x762x15 mm **FOLDED:** 380x370x50 mm  
**INCLUDES:** MC4 cable (5m), crocodile clips (30cm cable), solar charge controller  
**CHARGES:** 12V battery, smartphone, laptop, tablet, power station  
**IP64**

Ref. m [kg] EAN  
90-141 3,5 1/3 5907558466188

**NEO**  
TOOLS



**140W** **max 18V**  
**2xUSB +USB C** **IP64**  
**OPEN:** 1678x548x15 mm **FOLDED:** 548x455x40 mm  
**INCLUDES:** MC4 cable (5m), crocodile clips (30cm cable), solar charge controller  
**CHARGES:** 12V battery, smartphone, laptop, tablet, power station

Ref. m [kg] EAN  
90-142 4,4 1/3 5907558466195

**NEO**  
TOOLS



**100W**  
**IP67**  
**INCLUDES:** MC4 cable, mounting bolts  
**SEMI-FLEXIBLE**  
**850x710x2.8 mm**  
**CHARGES:** 12V battery

Ref. m [kg] EAN  
90-143 2,5 1/3 5907558466201

**NEO**  
TOOLS

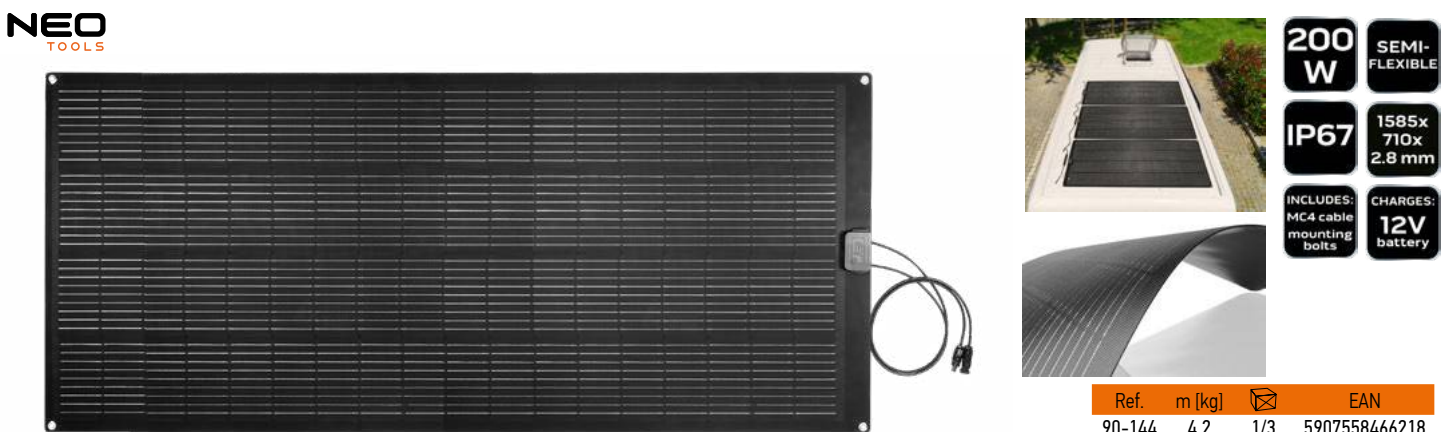

**200W** **SEMI-FLEXIBLE**  
**IP67** **1585x710x2.8 mm**  
**INCLUDES:** MC4 cable, mounting bolts  
**CHARGES:** 12V battery

Ref. m [kg] EAN  
90-144 4,2 1/3 5907558466218



## Regulator napięcia

Solar charge controller / Solarladeregler / Контроллер заряда солнечной энергии / Сонячний контролер заряду / Napelemes töltésvezérlő / Controler de încărcare solară / Solární regulátor nabíjení / Solárny regulátor nabíjania / Solarni regulator polnjenja / Saulės įkrovimo valdiklis / Saules uzlādes kontrolieris / Päikesenergia laengu kontrollier / Соларен контролер за зареждане / Solarni regulator punjenja / Контролер сопарное пуньеня / Ελεγκτής ηλιακής φόρτισης / Regulador de carga solar / Regolatore di carica solare / Solar laadregelaar / Contrôleur de charge solaire /

NEO  
TOOLS



10A  
12/24  
V



Ref. EAN  
90-145 1/1 5907558466249

NEO  
TOOLS



20A  
12/24  
V



Ref. EAN  
90-150 1/1 5907558467697

## Przewód podłączeniowy MC4

Connection cable MC4 / Anschlusskabel / Соединительные кабели / З'єднувальні кабелі / Kábelek csatlakoztatása / Cabluri de conectare / Propojovací kabely / Pripojovacie káble / Priključni kabli / Jungiamieji kabeliai / Savienojuma kabeli / Kaablite ühendamine / Свързващи кабели / Priključni kabeli / Прикључни каблови / Καλώδια σύνδεσης / Cables de conexión / Cavi di collegamento / Kabels aansluiten / Câbles de connexion

NEO  
TOOLS

MC4 DC 5.5x2.5 mm 2m cable



Ref. EAN  
90-148 1/1 5907558466270

NEO  
TOOLS

MC4 DC 5.5x2.5 mm 5m cable



Ref. EAN  
90-149 1/1 5907558466287

NEO  
TOOLS

MC4  
5m  
cable



Ref. EAN  
90-147 1/1 5907558466263

## Przewody podłączeniowe "krokodylki"

Crocodile clips / Anschlusskabel / Соединительные кабели / З'єднувальні кабелі / Kábelek csatlakoztatása / Cabluri de conectare / Propojovací kabely / Pripojovacie káble / Priključni kabli / Jungiamieji kabeliai / Savienojuma kabeli / Kaablite ühendamine / Свързващи кабели / Priključni kabeli / Прикључни каблови / Καλώδια σύνδεσης / Cables de conexión / Cavi di collegamento / Kabels aansluiten / Câbles de connexion

NEO  
TOOLS

30  
cm



Ref. EAN  
90-146 1/1 5907558466256







# DOM I GARAŽ

HOUSE AND GARAGE ДІМ І ГАРАЖ



# Wentylator

Fan / Fan / вентилатор / вентилятор / ventilátor / ventilator / větrák / vetrák / Ventilator / Ventilatorius / Ventilators / Ventilator / Вентилятор / Ventilator / Πελαζ / Ανεμιστήρας / Admirador / Fan / Fan / Ventilateur

**NEO**  
TOOLS



Ref. 90-001  
EAN 0/1 5907558442717

**NEO**  
TOOLS



Ref. 90-002  
EAN 0/1 5907558442724

**NEO**  
TOOLS



Ref. 90-003  
EAN 0/1 5907558442731

**NEO**  
TOOLS



Ref. 90-004  
EAN 0/1 5907558442731

**NEO**  
TOOLS



Ref. 90-007  
EAN 0/1 5907558442779

**NEO**  
TOOLS

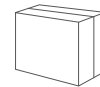

Ref. 90-008  
EAN 0/1 5907558442786

**NEO**  
TOOLS



Ref. 90-009  
EAN 0/1 5907558466225

**NEO**  
TOOLS

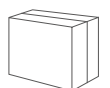

Ref. 90-010  
EAN 0/1 5907558466232



# Promiennik

Infrared heater / Heizkörper / Радиатор / Radiator / Radiator / Radiator / Radiator / Infrardeči grelec / Infraradonuij spindulij šildytuvas / Infrasarkanais sildītājs / Infrapuna kütteseade / Инфракрасен нагревател / Infracveni grijač / Инфрацрвени грејач / Υπέρθερη θερμάστρα / Calentador de infrarrojos / Riscaldatore a infrarossi / Infrarood verwarming / Chauffage infrarouge

**NEO**  
TOOLS



Ref. 90-030 0/6 EAN 5907558447415

**NEO**  
TOOLS



Ref. 90-031 0/6 EAN 5907558447422

**NEO**  
TOOLS



Ref. 90-039 0/4 EAN 5907558457902

**NEO**  
TOOLS



Ref. 90-032 0/4 EAN 5907558447439

**NEO**  
TOOLS



Ref. 90-034 0/2 EAN 5907558447453

**NEO**  
TOOLS



Ref. 90-037 0/1 EAN 5907558457889

**NEO**  
TOOLS



Ref. 90-038 0/1 EAN 5907558457896

**NEO**  
TOOLS

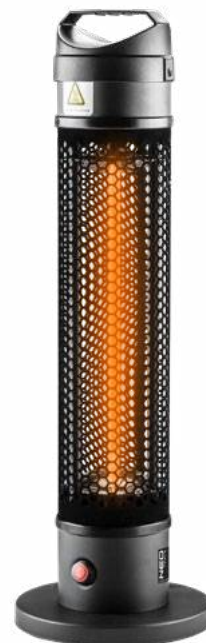

Ref. 90-035 0/4 EAN 5907558447460



## Promiennik

Infrared heater / Heizkörper / Ραδιатор / Ραδιатор / Radiátor / Radiator / Radiátor / Radiator / Infrardeči grelec / Infraraudontijų spindulių šildytuvas / Infrasarkanais šildītājs / Infrarūna kütteseade / Инфрарчервен нагревател / Infracrveni grijač / Инфрацрвени грејач / Υπέριθρη θερμάστρα / Calentador de infrarrojos / Riscaldatore a infrarossi / Infrarood verwarming / Chauffage infrarouge

NEO  
TOOLS



Ref. EAN  
90-036 0/1 5907558457872

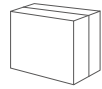

## Statyw

Tripod / Stativ / Штатив / Штатив / Hárómlábú / Trepied / Stativ / Stativ / Stojalo / Trikojjs / Stativs / Stativ / Статив / Τρονοζας / Τρονοζακ / Τρίποδο / Tripode / Treppiedi / Statief / Trépied

NEO  
TOOLS

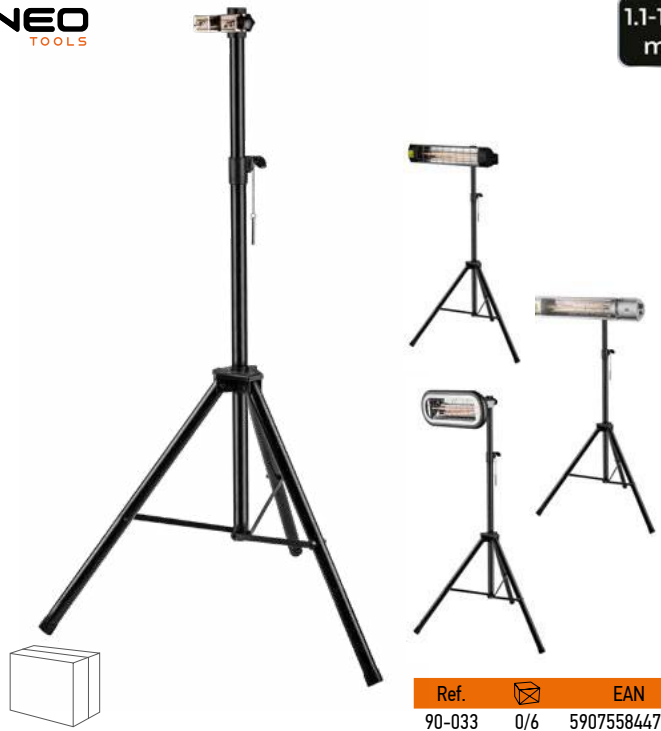

1.1-1.8  
m

Ref. EAN  
90-033 0/6 5907558447446



## Nagrzewnica

Electric heater / Elektrische Heizung / Электрический нагреватель / Электричний обігрівач / Hősugárgó / Incalzitör electric / Elektrický ohřivač / Elektrický ohrievač / Električni grelec / Elektrinis šildytuvas / Elektriskais šildītājs / Elektrikeris / Elektricheski nagrevatel / Električni grijač / Električni greјач / Ηλεκτρική θερμάστρα / Calentador eléctrico / Stufa elettrica / Elektrische verwarming / Chauffage électrique

NEO  
TOOLS



Ref. P [kW] [m³/h] EAN  
90-060 2 139 0/1 5907558447477  
90-061 3 210 0/1 5907558447484

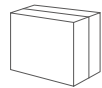

NEO  
TOOLS



Ref. P [kW] [m³/h] EAN  
90-062 2 197 0/8 5907558447491  
90-063 3 280 0/1 5907558447507  
90-064 5 588 0/1 5907558447514



NEO  
TOOLS



Ref. P [kW] [m³/h] EAN  
90-065 2 253 0/1 5907558447521  
90-066 3 291 0/1 5907558447538

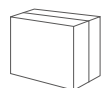

NEO  
TOOLS



Ref. P [kW] [m³/h] EAN  
90-067 2 330 0/1 5907558447545  
90-068 3 354 0/1 5907558447552  
90-069 5 366 0/1 5907558447569



## Nagrzewnica i wentylator

/ Electric heater and fan / Обогреватель и вентилятор / Fűtés és ventilátor / Нагрівач і вентилятор / Incalzitor si ventilator / Heizung und Lüfter / Ohřivač a ventilátor / Ohřivač a ventilátor Električni grelec / Elektrinis šildytuvas / Elektriskais sildītājs / Elektrikeris / Електрически нагревател / Električni grijač / Електрични грејач / Ηλεκτρική θερμάστρα / Calentador eléctrico / Stufa elettrica / Elektrische verwarming / Chauffage électrique

**NEO**  
TOOLS

MANUAL



2400W

2 in 1



Ref.	P [kW]	[m³/h]	☒	EAN
90-070	2,4	460	0/4	5907558447576

**NEO**  
TOOLS

DIGITAL



2400W

2 in 1



Ref.	P [kW]	[m³/h]	☒	EAN
90-071	2,4	460	0/4	5907558447583

## Nagrzewnica olejowa

Oil heater / Ölheizung / Масляный нагреватель / Масляний нагрівач / Olajmelegítő / Încalzitor cu ulei / Ohřivač oleje / Ohřivač oleja / Grelnik olja / Alyvos šildytuvas / Eļļas sildītājs / Öliikütteseade / Нагревател на масло / Grijač ulja / Грејач уља / Θερμαντήρας λαβίου / Calentador de aceite / Riscaldatore dell'olio / Olie warmer / Réchauffeur d'huile

**NEO**  
TOOLS

20 kW

DIESEL OIL/  
KEROSENE

550 m³/h

19 l

**NEO**  
TOOLS

DIESEL OIL/  
KEROSENE



Ref.	P [kW]	[m³/h]	☒	EAN
90-080	20	550	0/1	5907558457919



Ref.	P [kW]	[m³/h]	l	☒	EAN
90-081	30	750	34	0/1	5907558457926
90-082	50	1100	50	0/1	5907558457933

## Nagrzewnica gazowa

Gas heater / Gasheizung / Газовый обогреватель / Газовий обігрівач / Gázmelegítő / Incalzitor pe gaz / Plynový ohřivač / Plynový ohřivač / Plinski grelec / Dujinis šildytuvas / Gāzes sildītājs / Gaasikütteseade / Газов нагревател / Plinski grijač / Гасни грејач / Θερμαντήρας αερίου / Calentador a gas / Stufa a gas / Gaskachel / Chauffage à gaz

**NEO**  
TOOLS

GAS  
heater

PIEZO

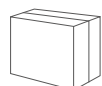

Ref.	P [kW]	[m³/h]	[bar]	☒	EAN
90-083	15	580	0,7	0/1	5907558457940
90-084	30	1000	0,7	0/1	5907558457957
90-085	50	1000	1,5	0/1	5907558457964



## Grzejnik

Heater / Heizgerät / Нагреватель / Ηεραγωγός / Elektromos fűtőpanel / Radiator / Ohříváč / Ohřivač / Grelec / Šildytuvus / Sildītājs / Soojendi / Ηερεωαμεν / Grijač / Грејач / Θερμάστρα / Calentador / Riscaldatore / Kachel / Chauffe-eau

**NEO**  
TOOLS



Ref.	P [W]	☒	EAN
90-090	1000	0/1	5907558447590
90-091	1500	0/1	5907558447606
90-092	2000	0/1	5907558447613

**NEO**  
TOOLS



Ref.	P [W]	☒	EAN
90-093	1000	0/1	5907558447620
90-094	1500	0/1	5907558447637
90-095	2000	0/1	5907558447644

## Panel grzewczy na podczerwień

Infrared heating panel / Infrarot-Heizplatte / Инфракрасная нагревательная панель / Панель инфрачервоного опалення / Infrarörs fűtőpanel / Ραπου de incalzire cu infrarosu / Infracervený topný panel / Infracervený vykurovací panel / Infrardeči grelni panel / Infraraudonijū spinduliu šildymo plokštė / Infrasarkanais arkures panelis / Infrarūna kūtterepeel / Инфрачервен панел за отопление / Infracrveni grijači panel / Инфрацрвена грејна плоча / Πάνελ υπέρυθρης θέρμανσης / panel de calefacción por infrarrojos / Pannelo riscaldante a infrarossi / Infrarood verwarmingspaneel / Panneau chauffant infrarouge

**NEO**  
TOOLS

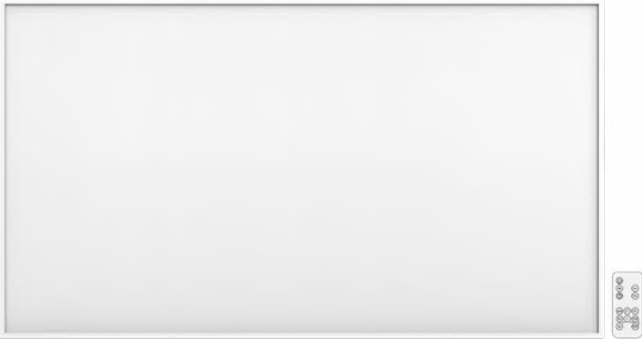

Ref.	P [W]	☒	EAN
90-102	450	0/1	5907558461695
90-103	600	0/1	5907558461701
90-104	720	0/1	5907558461718

**NEO**  
TOOLS

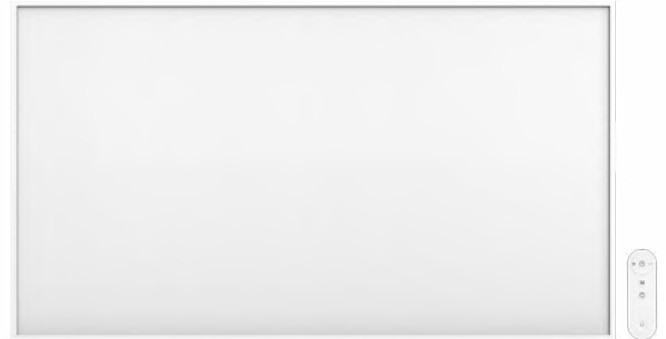

Ref.	P [W]	☒	EAN
90-105	450	0/1	5907558461725
90-106	600	0/1	5907558461732
90-107	720	0/1	5907558461749

## Wspornik sufitowy

Ceiling bracket / Deckenhalterung / Потолочный кронштейн / Кронштейн для стени / Mennyezeti konzol / Support de tavan / Stropní držák / Stropná konzola / Stropni nosilec / Lubų laikiklis / Griestu kronšteins / Laekinnitus / Сноба за таван / Stropni nosač / Стронни носач / Βάση οροφής / Saporite de techo / Staffa soffitto / Plafondbeugel / Support de plafond

**NEO**  
TOOLS



Ref.	For panels:	☒	EAN
90-108	90-102/90-103/ 90-105 / 90-106	0/1	5907558462326
90-108-1	90-104/90-107	0/1	5907558462432

## Nogi

Feets / Füße / Hozu / Hozu / Édességék / Picioare / Nohy / Feety / Stopala / Saldainiai / Saldumi / Maiustused / Крѡка / Stopala / Смонана / Πόδια / Pies / Feets / Voeten / Pieds

**NEO**  
TOOLS



Ref.	For panels:	☒	EAN
90-109	90-102 / 90-103 / 90-104 / 90-105 / 90-106 / 90-107	0/1	5907558462333



## Oczyszczacz powietrza

Air purifier / Luftreiniger / Устройство очистки воздуха / Пристрій очищення повітря / Légtisztító készülék / Dispositiv de purificare a aerului / Zařízení na čištění vzduchu / Zariadenie na čistenie vzduchu / Naprava za čiščenje zraka / Oro valymo įtaisas / Gaisa attīrīšanas ierīce / Одувањастусеаде / Устройство за пречишћавање на вьздух / Uredaj za pročišćavanje zraka / Уредбај за пречишћавање ваздуха / Συσκευή καθαρισμού αέρα / Dispositivo purificador de aire / Dispositivo purificatore d'aria / Luchtreiniger / Dispositif de purificateur d'air

**NEO**  
TOOLS



K112945



Filters more than 99% of bacteria, virus, dust etc.



Ref.	⊞	EAN
90-121	0/4	5907558451016
K112945	0/12	5902062063564

**NEO**  
TOOLS



K112946



Filters more than 99% of bacteria, virus, dust etc.

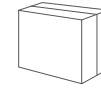

Ref.	⊞	EAN
90-122	0/2	5907558451023
K112946	0/12	5902062063571

**NEO**  
TOOLS



K112948



Filters more than 99% of bacteria, virus, dust etc.



K112950

K112951



Ref.	⊞	EAN
90-125	0/1	5902062062758
K112948	0/1	5902062063595
K112951	0/1	5902062063618
K112950	0/1	5902062063601

**NEO**  
TOOLS



K112947



Filters more than 99% of bacteria, virus, dust etc.



K112950



Ref.	⊞	EAN
90-127	0/1	5902062062772
K112947	0/1	5902062063588
K112950	0/1	5902062063601









# OGRÓD

GARDEN САД



## Zraszacz pistoletowy

Water spray gun / Опрыскатель пистолетный / Sprühpistole Spritze / Опрыскувач пистолетный / Őntöző pisztoly / Pistol de stropire / Postřikovací pistole / Pištoloňový postrekovač / Brizgalna pištola / Purkštukas - pistoletas / Laistīšanas pistole / Pūstol-pihustusotsak / Пистолет струйник / Raspršivač na pištoli / Pištoli prskalica / Εκτοξευτής νερού πιστόλι / Aspersor tipo pistola / Irrigatore a pistola / Pistola de aspersão / Arroiseur à pistolet / Spuitpistool

**NEO**  
TOOLS

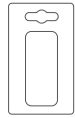
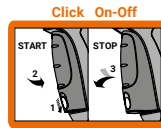

Ref. 15-705    12/48    EAN 5907558451481

**NEO**  
TOOLS

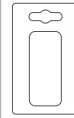
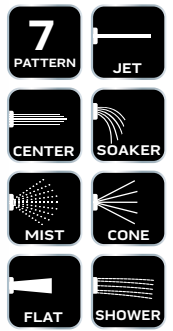

Ref. 15-706    12/48    EAN 5907558451498

**NEO**  
TOOLS

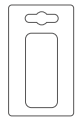

Ref. 15-707    12/48    EAN 5907558451504

**NEO**  
TOOLS

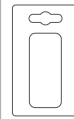

Ref. 15-708    6/24    EAN 5907558451511

**VERTO**

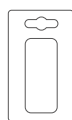
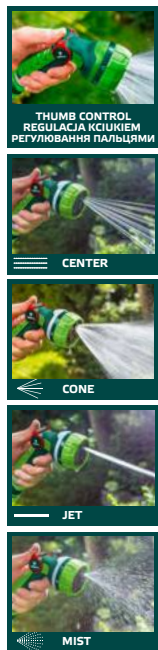

Ref. 15G710    12/48    EAN 5902062037824

**VERTO**

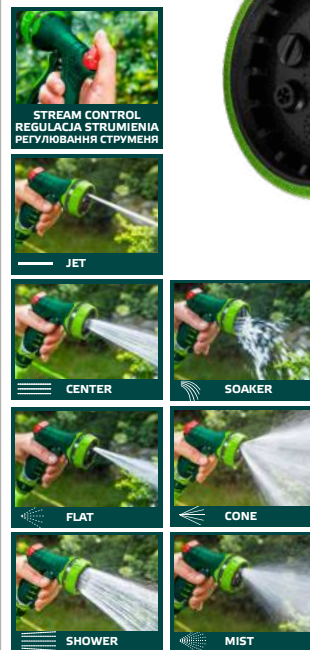

Ref. 15G707    12/24    EAN 5902062037794



## Zraszacz pistoletowy

Water spray gun / Ороситель пистолетный / Sprühpistole Spritze / Опрыскивач пистолетный / Őntöző pisztoly / Pistol de stropire / Postřikovací pistole / Pištolový postrekovač / Brizgalna pištola / Purkštukas - pistoletas / Laistīšanas pistole / Pūstol-pihustusotsak / Пистолет струйник / Raspršivač na pištoly / Pištoly prskalica / Εκτοξευτής νερού πιστόλι / Aspersor tipo pistola / Irrigatore a pistola / Pistola de aspersão / Arroseur à pistolet / Spuitpistool

### VERTO



THUMB CONTROL  
REGULACJA KCIKIEM  
РЕГУЛЮВАННЯ ПАЛЬЦЯМИ

VERTICAL MIST

FLAT CONE

CENTER JET

SHOWER STREAM

Ref. 15G704 12/48 EAN 5902062037763

### VERTO



LOCK  
BLOKADA  
БЛОКІРОВКА

SOAKER

FLAT MIST

JET CENTER

SHOWER VERTICAL

CONE STREAM

Ref. 15G702 12/48 EAN 5902062037749

### VERTO



THUMB CONTROL  
REGULACJA KCIKIEM  
РЕГУЛЮВАННЯ ПАЛЬЦЯМИ

CONE

MIST

JET

Ref. 15G709 12/36 EAN 5902062037817

### VERTO



STREAM CONTROL  
REGULACJA STRUMIENIA  
РЕГУЛЮВАННЯ СТРУМЕНЯ

LOCK  
BLOKADA  
БЛОКІВАННЯ

JET

CONE

Ref. 15G706 12/48 EAN 5902062037787

### VERTO



STREAM CONTROL  
REGULACJA STRUMIENIA  
РЕГУЛЮВАННЯ СТРУМЕНЯ

THUMB CONTROL  
REGULACJA KCIKIEM  
КОРИГУВАННЯ ПАЛЬЦЯМИ

JET

CONE

Ref. 15G703 12/48 EAN 5902062037756

### VERTO



WIDE STREAM  
SZEROKI STRUMIEN  
ШИРОКИЙ СТРУМІНЬ

WATER PRESSURE REGULATION  
REGULACJA CIŚNIENIA WODY  
РЕГУЛЮВАННЯ НАЛОРУ ВОДИ

ERGONOMIC SHAPE  
ERGONOMICZNY KSZTAŁT  
ЕРГОНОМІЧНА ФОРМА

Ref. 15G708 0/14 EAN 5902062037800



## Zraszacz pistoletowy

Water spray gun / Ороситель пистолетный / Sprühpistole Spritze / Опрыскивач пистолетный / Őntöző pisztoly / Pistol de stropire / Postřikovací pistole / Pištlový postrekovač / Brizgalna pištola / Purkštukas - pistoletas / Laistīšanas pistole / Pūstol-pihustusotsak / Пистолет струйник / Raspršivač na pištól / Pištólj prskalica / Εκτοξευτής νερού πιστόλι / Aspersor tipo pistola / Irrigatore a pistola / Pistola de aspersão / Arroiseur à pistolet / Spuitpistool

### VERTO

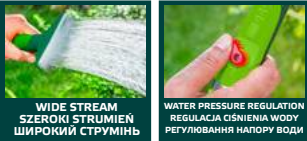

WIDE STREAM  
SZEROKI STRUMIEN  
ШИРОКИЙ СТРУМИНЬ

WATER PRESSURE REGULATION  
REGULACJA CIŚNIENIA WODY  
РЕГУЛЮВАННЯ НАПОРУ ВОДИ

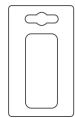

Ref.	📦	EAN
15G705	12/48	5902062037770

## Zraszacz prosty

Straight water spray nozzle / Sprühregner / Ороситель прямой / Зрошувач прямий / Őntöző fej / Spritzer stropit / Postřikovač na hadici / Jednoduchý postrekovač / Ravna brizgalka / Tiesiu purkštukas / Laistīšanas uzgalis (taisnais) / Tavaline pihustusotsak / Прав струйник / Obični raspršivač / Obična prskalica / Εκτοξευτής νερού λήξη / Aspersor recto / Irrigatore dritto / Agulheta de aspersão / Arroiseur simple / Spuitpistool

### NEO TOOLS

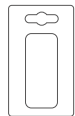

Ref.	📦	EAN
15-700	12/48	5907558451399

### VERTO



STREAM CONTROL  
REGULACJA STRUMIENIA  
РЕГУЛЮВАННЯ СТРУМЕНЯ

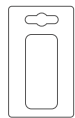

Ref.	📦	EAN
15G700	12/48	5902062037725

### VERTO



STREAM CONTROL  
REGULACJA STRUMIENIA  
РЕГУЛЮВАННЯ СТРУМЕНЯ



BIMATERIAL  
DWA MATERIAŁOWY  
ДВОКОМПОНЕНТНИЙ

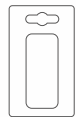

Ref.	📦	EAN
15G701	10/50	5902062037732

### VERTO



Ref.	📦	EAN
15G715	6/24	5902062092533

## Zestaw ze zraszaczem prostym

Gardening set with straight nozzle / Набор с прямым оросителем / Set mit Sprühregner / Набор із прямим зрошувачем опрыскивачем / Őntöző fej szett / Set cu spritzer de stropit / Sada s postřikovačem na hadici / Súprava s jednoduchým postrekovačem / Komplet z ravno brizgalko / Laistymo komplektas su tiesiu purkštuku / Komplekts ar taisno laistīšanas uzgali / Tavalise atsakuga komplekt / Комплект с прав струйник / Set s običnim raspršivačem / Pribor sa običnom prskalicom / Σετ με εκτοξευτή νερού λήξη / Set con aspersor recto pistola / Kit irrigatore dritto / Kit com agulheta de aspersão / Ensemble d'arroiseur simple / Set met spuitpistool

### NEO TOOLS

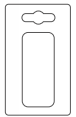

Ref.	Ø ["]	📦	EAN
15-710	1/2	12/48	5907558451405
15-711	3/4	12/48	5907558451412

### VERTO



STREAM CONTROL  
REGULACJA STRUMIENIA  
РЕГУЛЮВАННЯ СТРУМЕНЯ

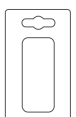

Ref.	📦	EAN
15G711	6/48	5902062037831



## Zestaw ze zraszaczem pistoletowym

Gardening set with water spray gun / Набор пистолетным опрыскивателем / Set mit Sprühpistole / Набор із пистолетним опрыскувачем / Öntöző pisztoly szett / Set cu pistol de stropire / Sada s postřikovací pistolí / Súprava s pištoľovým postrekovačom / Komplet z brízglatno pištoľo / Laistymo komplektas su purkštuku pistoletu / Komplekts ar taisno laistīšanas pistoli / Tavalise pūstoltsakuga komplekt / Комплект с пистолетом струйник / Set s raspršivačem na pištoľ / Pribor sa pištoľj prskalicom / Σετ με εκτοξευτή νερού πιστόλι / Set con aspersor tipo pistola / Kit irrigatore a pistola / Kit com pistola de aspersão / Ensemble d'arroseur à pistolet / Tuingereedschapsriem

**VERTO**

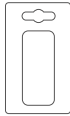

Ref. 15G713 10/50 EAN 5902062037848

**VERTO**

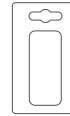

Ref. 15G712 6/48 EAN 5902062038364

## Zraszacz oscylacyjny

Oscillating sprinkler / Rosensprenger / Дождеватель маятниковый / Зрошувач оциляційний / Billenő öntöző / Aspersor oscilant / Oscilační postřikovač / Oscilačný postrekovač / Nihajni zalivalnik / Švytuoklinis purkštukas / Dārza laistītājs / Pöörtev pihustusotsak / Осциллятор разпрыскач / Oscilirajući raspršivač / Oscilatorna prskalica / Ποτιστικό βεντάλια απριόνκλερ / Aspersor oscilante / Irrigatore oscillante / Aspersor oscilante / Arroseur oscillant / Slanghaspel gemonteerd

**NEO TOOLS**



**18**  
nozzles

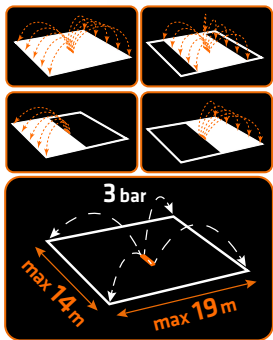

Ref. 15-771 0/6 EAN 5907558451375

**NEO TOOLS**



**20**  
nozzles

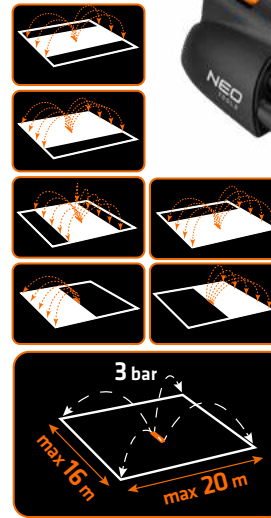

Ref. 15-772 0/6 EAN 5907558451382

**VERTO**

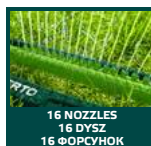

Ref. 15G770 10/20 EAN 5902062038012

**VERTO**

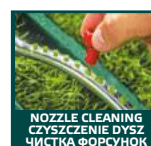
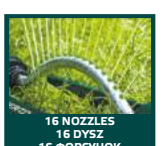

Ref. 15G771 0/8 EAN 5902062038029



## Zraszacz oscylacyjny

Oscillating sprinkler / Rasensprenger / Дождеватель маятниковый / Зрошувач осциляційний / Billenő öntöző / Aspersor oscilant / Oscilační postřikovač / Oscilačný postrekovač / Nihajni zalivalnik / Šyruoklinis purkštukas / Dārza laistītājs / Põrlev pihustusotsak / Осциллятор разпрыскач / Oscilirajući raspršivač / Oscilatorna prskalica / Ποτιστικό βεντάλια σπρίνκλερ / Aspersor oscilante / Irrigatore oscillante / Aspersor oscilante / Arroseur oscillant / Slanghaspel gemonteerd

**VERTO**



NOZZLE CLEANING  
CZYSZCZENIE DYŚZ  
ЧИСТКА ФОРСУНОК



WIDTH ADJUSTMENT  
REGULACJA SZEROKOŚCI  
РЕГУЛЮВАННЯ ШИРИНИ

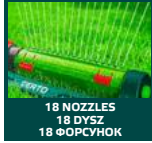

18 NOZZLES  
18 DYŚZ  
18 ФОРСУНОК



ANGLE ADJUSTMENT  
REGULACJA KĄTA  
РЕГУЛЮВАННЯ КУТА

Ref. 15G772 4/8 EAN 5902062038036

**VERTO**



ANGLE ADJUSTMENT  
REGULACJA KĄTA  
РЕГУЛЮВАННЯ КУТА



WIDTH ADJUSTMENT  
REGULACJA SZEROKOŚCI  
РЕГУЛЮВАННЯ ШИРИНИ



STREAM CONTROL  
REGULACJA STRUMIENIA  
РЕГУЛЮВАННЯ СТРУМЕНЯ



16 NOZZLES  
16 DYŚZ  
16 ФОРСУНОК

Ref. 15G773 6/12 EAN 5902062038043

## Zraszacz ogrodowy

Garden sprinkler / Gartensprenger / Ороситель садовый / Опрыскавач садовий / Kerti locsoló / Sprinkler de grădină / Zahradní postřikovač / Záhradný postrekovač / Vrtni zalivalnik / Sodo purkštukas / Dārza laistītājs / Аіаріһітсі / Градинска прскачка / Orošivač za vrt / Prskalica za baštu / Εκτοξευτής κήπου / Aspersor de jardín / Irrigatore da giardino

**NEO**  
TOOLS



Ref. 15-780 4/24 EAN 5907558451368

**VERTO**



COVERAGE CONTROL  
REGULACJA ZASIĘGU  
РЕГУЛЮВАННЯ СТРУМЕНЯ

Ref. 15G788 0/6 EAN 5902062054395

**VERTO**



8-PATTERN  
8-FUNKCJI  
8-ФУНКЦІЙ

Ref. 15G780 0/6 EAN 5902062054374

**VERTO**



9-PATTERN  
9-FUNKCJI  
9-ФУНКЦІЙ

Ref. 15G781 0/6 EAN 5902062054371



0-360°

Ref. 15G785 12/48 EAN 5902062054388



## Złączka

Connector / Kupplung / Соединитель / З'єднувальний елемент / Csatlakozó / Manşon / Spojka / Spojáci člínok / Spojka / Jungtis / Savienotājs / Ühendused / Муфта / Klema / Spojka / Σύνδεσμος / Conector / Raccordo / União / Raccord / Spreier

**NEO**  
TOOLS



1/2"  
QUICK  
CONNECT  
BRASS

Ref.	Ø ["]	Info	☒	EAN
15-730	1/2	-	12/48	5907558464375
15-731	1/2	STOP	12/48	5907558464382

**NEO**  
TOOLS



3/4"  
QUICK  
CONNECT  
BRASS

Ref.	Ø ["]	Info	☒	EAN
15-732	3/4	-	12/48	5907558464399
15-733	3/4	STOP	12/48	5907558464405

**NEO**  
TOOLS



1/2"  
QUICK  
CONNECT  
BIMATERIAL

Ref.	Ø ["]	Info	☒	EAN
15-720	1/2	-	12/96	5907558464474
15-721	1/2	STOP	12/96	5907558464481

**NEO**  
TOOLS



3/4"  
QUICK  
CONNECT  
BIMATERIAL

Ref.	Ø ["]	Info	☒	EAN
15-722	3/4	-	12/96	5907558464498
15-723	3/4	STOP	12/96	5907558464504

**VERTO**



Ref.	Ø ["]	N	☒	EAN
15G720	1/2	x1	12/96	5902062037855
15G720-30	1/2	x30	0/1	5902062050601

**VERTO**



Ref.	Ø ["]	N	☒	EAN
15G722	3/4	x1	12/96	5902062037879
15G722-30	3/4	x30	0/1	5902062050625

**VERTO**



Ref.	Ø ["]	N	☒	EAN
15G721	1/2	x1	12/96	5902062037862
15G721-30	1/2	x30	0/1	5902062050618

**VERTO**



Ref.	Ø ["]	N	☒	EAN
15G723	3/4	x1	12/96	5902062037886
15G723-30	3/4	x30	0/1	5902062050632

**VERTO**



Ref.	Ø ["]	N	☒	EAN
15G732	3/4	x1	20/240	5902062037916
15G732-30	3/4	x30	0/4	5902062050663

**VERTO**



Ref.	Ø ["]	N	☒	EAN
15G730	1/2 - 5/8	x1	20/240	5902062037893
15G730-30	1/2 - 5/8	x30	0/4	5902062050649



## Złączka

Connector / Kupplung / Соединитель / З'єднувальний елемент / Csatlakozó / Manşon / Spojka / Spájací článok / Spojka / Jungtis / Savienotājs / Ühendused / Муфта / Klema / Spojka / Σύνδεσμος / Conector / Raccordo / União / Raccordo / Spreier

### VERTO



Ref.	N	☒	EAN
15G733	x1	20/240	5902062037923
15G733-30	x30	0/4	5902062050670

### VERTO



Ref.	Ø ["]	N	☒	EAN
15G731	1/2 - 5/8	x1	20/240	5902062037909
15G731-30	1/2 - 5/8	x30	0/4	5902062050656

## Rozdzielacz typu Y

3 way hose connector / Y-Schlauchverteiler / Тройник / Сенаратор-трійник / 3-utas csatlakozó / Conector extensie triplu / Y-kus / Rozdelovacia typ Y / Rozdelník typu Y / Τρίαικis greito jungimo laistymo žarnos sujungti, Y tipo / Y tipa sadalītājs / Y-tüüpi jaotur / Тройник за бърза връзка / Y razvodnik / Rozdelnik tipa Y / Σύνδεσμος τριών ταχυσυνδέσιμων / Derivación tipo Y triple / Raccordo a Y / União em Y / Répartiteur de type Y / 3-weg stuk Y

### NEO TOOLS



Ref.	☒	EAN
15-748	12/48	5907558464450
15-744	12/96	5907558464559

### VERTO



Ref.	N	☒	EAN
15G744	x1	12/96	5902062037978
15G744-30	x30	0/1	5902062050717

## Złącze typu I

2 way connector / Schlauchverbinder gerade / Двоійник / З'єднувач типу I / Tömöl összekötő csatlakozó / Cupla furton / Hadicová spojka / Spojka typ I / Dvojni priključek za cev / Jungtis laistymo žarnos sujungti, I tipo / I tipa savienotāji / I-tüüpi ühendus / Съединител за бърза връзка / Spoj typ I / Priključak tipa I / Σύνδεσμος δύο ταχυσυνδέσιμων / Conector tipo I / Raccordo dritto / União em I / Connecteur raccord de type I / 1-weg stuk I

### NEO TOOLS



Ref.	☒	EAN
15-749	12/48	5907558464467
15-745	12/96	5907558464566

### VERTO



Ref.	N	☒	EAN
15G745	x1	12/96	5902062037985
15G745-30	x30	0/1	5902062050724

## Szybkozłączka

Quick coupler / Schnellkupplungen / Быстросменная муфта / Муфта швидкокорознімна / Pneumatikus gyorscsatlakozó / Conector rapid / Rychlospojka / Rychlospojka / Hitra spojka / Greitoji jungtis / Atrsavienotājs / Kiirühendus / Бърза връзка / Spojnica / Brzo odvajanje / Συζευκτήρας ταχείας απελευθέρωσης / Acoplador rápido / Connettere rapido con presa per tubo / União rápida / Rapport rapide / Snelkoppeling

### NEO TOOLS



Ref.	Ø ["]	☒	EAN
15-620	1/2	10/60	5907558465044
15-622	3/4	10/60	5907558465051
15-623	1	10/60	5907558465068
15-624	1 1/4	10/60	5907558465075

### NEO TOOLS



Ref.	Ø ["]	☒	EAN
15-632	1	10/60	5907558465082
15-633	1 1/4	10/60	5907558465099
15-642	1	10/60	5907558465105

## Reparator do węży

Hose repair connector / Schlauchverbinder / Универсальная ремонтная муфта / Penarator do szlangu / Tömöloldó javító / Cupla imbinare furton / Hadicová oprávka / Hadicová spojka / Reparator za cev / Jungtis žarnai / Remontuzmava dārza šļūtenei / Vooliku parandamise ühendus / Муфта-съединител за маркуч / Reparator za crijevo / Reparator za crevo / Σύνδεσμος για ένωση δύο λάστιχων / Reparador de mangueira / Raccordo riparatore / Reparador de mangueira / Réparateur de tuyau / Knelkoppeling

### NEO TOOLS



Ref.	Ø ["]	☒	EAN
15-736	1/2	12/48	5907558464412
15-737	3/4	12/48	5907558464429

### NEO TOOLS



Ref.	Ø ["]	☒	EAN
15-742	1/2	12/96	5907558464535
15-743	3/4	12/96	5907558464542

### VERTO



Ref.	Ø ["]	N	☒	EAN
15G742	1/2	x1	12/96	5902062037954
15G742-30	1/2	x30	0/1	5902062050694
15G743	3/4	x1	12/96	5902062037961
15G743-30	3/4	x30	0/1	5902062050700

### VERTO



Ref.	Ø ["]	N	☒	EAN
15G746	1/2	x1	20/240	5902062054418
15G747	3/4	x30	20/240	5902062054425





## Przylacze do kranu

Hose tap connector / Hahnstück / Адаптер на кран / Адаптер до крану / Csapcsatlakozó / Adaptor robinet / Přípojka na kohoutek / Přípojka na vodovod / Priključek za pipo / Čiaupo jungtis / Krāna īscaurules / Kraaniühendus / Адаптор за кран / Priključak za slavinu / Priključak za slavinu / Ρακόρ για βρύση / Conector para grifo / Adattatore per rubinetto / União de torneira / Ajutaje de robinet / Kraanverbinstuk

**NEO**  
TOOLS

**BRASS**



Ref.	Ø ["]	⊠	EAN
15-746	1/2 - 3/4	12/48	5907558464436
15-747	3/4 - 1	12/48	5907558464443

**NEO**  
TOOLS



Ref.	Ø ["]	⊠	EAN
15-740	1/2 - 3/4	12/96	5907558464511
15-741	3/4 - 1	12/96	5907558464528

**VERTO**



Ref.	Ø ["]	N	⊠	EAN
15G740	1/2 - 3/4	x1	12/96	5902062037930
15G740-30	1/2 - 3/4	x30	0/6	5902062050687

**NEO**  
TOOLS

**3 TAPS**

**TAP CONNECTOR**  
Ø1"

**TAP CONNECTOR**  
Ø3/4"

**MECHANICAL WATER TIMER**

**MAX 120 MIN**



Ref.	⊠	EAN
15-750	0/10	5907558464351

**VERTO**



Ref.	⊠	EAN
15G760	12/72	5902062054432

**VERTO**



Ref.	⊠	EAN
15G761	10/40	5902062054449

## Wyłącznik czasowy

Timer switch / Wasserschaltuhr / Таймер для полива / Вимикач таймерний / Óntöző időzítő kapcsoló / Programator irigatii / Časový spínač / Časový spínač / Časovník / Laikma laikmatīs / Laika slēdzis / Taimeriga lūlīti / Таймер за изключване / Vremenski prekidač / Tajmer / Χρονοβιοκόπτης ποτίσματος / Temporizador / Interruttore temporizzato / Programador de rega / Minuterie d'arrosage / Tijdschakelaar

**VERTO**



RIGHT / LEFT  
PRAVO / LEVO  
ПРАВА / ЛЕВА



## Opryskiwacz

Spraying machine / Spritzgerät / Опрыскиватель / Opryskuvach / Permetező / Aparat de stropit / Postřikovač / Postrekovalč / Škropilnik / Purkštuvav / Smidzinātājs / Piserdi / Пулверизатор / Prskalica / Prskalica / Ψεκαστήρας / Aspersor / Atomizzatore / Máquina regadora / Pulvérisateur / Spuittoestel

**VERTO**



Ref.	Info	☒	EAN
156501	1l	0/20	5902062037237
156502	1,5l	0/15	5902062037244
156503	2l	0/15	5902062037251

**VERTO**

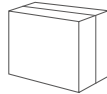

Ref.	Info	☒	EAN
156504	3l	1/6	5902062037268
156505	5l	1/6	5902062037275
156506	7l	1/6	5902062037282



SAFETY VALVE  
ZAWÓR BEZPIECZEŃSTWA  
ЗАПОБІЖНИЙ КЛАПАН



FLOW: MAX 1.6 L/MIN  
WYDAJNOŚĆ: MAX 1.6 L/MIN  
ПРОДУКТИВНІСТЬ: MAX 1.6 L/MIN



PRESSURE: MAX 2.5 BAR  
CIŚNIENIE: MAX 2.5 BAR  
ТІСК: MAX 2.5 BAR

**VERTO**

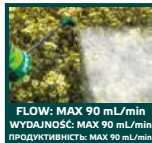

FLOW: MAX 90 mL/min  
WYDAJNOŚĆ: MAX 90 mL/min  
ПРОДУКТИВНІСТЬ: MAX 90 mL/min



PRESSURE: MAX 3.5 BAR  
CIŚNIENIE: MAX 3.5 BAR  
ТІСК: MAX 3.5 BAR

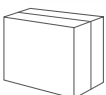

Ref.	Info	☒	EAN
156507	15l	0/1	5902062037299
156508	20l	0/1	5902062037305

## Stojak do węża

Hose reel stand / Schlauchtrommel mit Gestell / Катуха для шланга на подставке / Стійка до шлангу / Tomládob / Tambur pentru furturen / Stojan na hadici / Stojan na hadici / Stajalo za cev / Stovas žarnai / Dārza šļūtenes statīvs / Voolikhoidik / Макара за градински марнуч / Stalak za crijevo / Stalak za crevo / Καρούλι ποτισματος επιδαπέδιο / Soporte para manguera / Avvolgitubo / Enrolador de mangueira / Support de dévidoir-enrouleur / Slanghaspel gemonteerd

**NEO**  
TOOLS



METAL

100m  
1/2"

30m  
3/4"

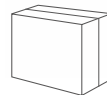

Ref.	☒	EAN
15-790	0/4	5907558451320

**NEO**  
TOOLS



60m  
1/2"

20m  
3/4"

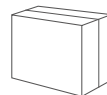

Ref.	☒	EAN
15-791	0/5	5907558451344

**VERTO**

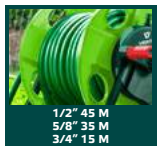

1/2" 45 M  
5/8" 35 M  
3/4" 15 M



PORTABLE  
PRZENOŚNY  
ПОРТАТИВНИЙ

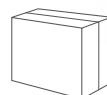

Ref.	☒	EAN
156790	0/6	5902062038104



## Wózek do węża

Hose reel trolley / Schlauchwagen / Катушка для шланга на колесах / Візок для шлангу / Tömlőkocsi / Cărucior suport pentru furtun / Vozik na hadici / Vozik na hadicu / Voziček za cev / Žarný vežimelis / Dārza šļūtenes ratiņi / Voolikukäru / Колучка за градински маркуч / Kolica za crijevo / Kolica za crevo / Καρούλι ποτιάματος τροχήλατο / Carretilla para manguera / Carrello avvolgitubo / Carrinho enrolador de mangueira / Chariot de tuyau d'arrosage / Haspelkar

NEO  
TOOLS



METAL

60m  
1/2"

20m  
3/4"

Ref. 15-792    Info 0/2    EAN 5907558451337

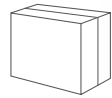

NEO  
TOOLS



60m  
1/2"

20m  
3/4"

Ref. 15-793    Info 0/5    EAN 5907558451351

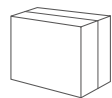

VERTO

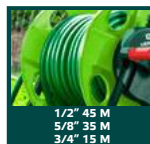

Ref. 156791    Info 0/6    EAN 5902062038111

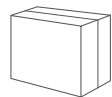

## Wieszak na węża

Hose hanger / Wandschlauchhalter / Вешалка для поливочного шланга / Підвішувач для шлангу / Tömlőtartó / Suport furtun / Závès na hadici / Vešiac na hadicu / Obešalnik za cev / Žarnos rakaba / Dārza šļūtenes turētājs / Vooliku riputuskonks / Стенна стойка за градински маркуч / Vješalica za crijevo / Vešalica za crevo / Βάση-Σέλα τοίχου για λάστιχο ποτιάματος / Colgador de manguera / Portatubo / Suporte de mangueira / Support de tuyau d'arrosage / Slangophang

VERTO



Ref. 156798    Info 20m x 1/2"    Info 0/50    EAN 5902062038128

## Prowadnica do węża rolkowa

Roller hose guide / Rollenschlauchführung / Роликовая направляющая для шланга / Направляюча роликового шланга / Görgös tömlővezető / Ghidaj furtun cu role / Vedení hadice válce / Vedenie hadice valčeka / Vodilo valjaste cevi / Ritiniņiņ žarnų kreiptuvas / Rullīšu šļūtenes vadotne / Rullivooliku juht / Водач за ролкови маркучи / Vodič valjkastog crijeva / Водич ваљаног црева / Οδηγός εύκαμπτου σωλήνα / Guia de mangueira de rodillo / Guida tubo a rullo / Guia da mangueira de rolo / Guide de tuyau à rouleau / Rolslangeleider

VERTO



Ref. 156851    Info 0/20    EAN 5902062507921

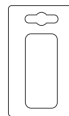

## Prowadnica do węża zamknięta

Hose guide closed / Schlauchführung geschlossen / Направляющая шланга закрыта / Направляюча шланга закрита / A tömlővezető csukva van / Ghidajul furtunului închis / Vedení hadice zavřené / Vedenie hadice zatvorené / Vodilo za cev je zaprto / Žarnos kreiptuvas uždarytas / Šļūtenes vadotne ir aizvērtā / Voolikujuhik on suletud / Водачът на маркуча е затворен / Vodič crijeva zatvoren / Водич за црево затворен / Ο οδηγός σωλήνα έκλεισε / Guia de mangueira cerrada / Guida del tubo chiusa / Guia de mangueira fechada / Guide de tuyau fermé / Slangeleider gesloten

VERTO



Ref. 156852    Info 6/24    EAN 5902062507938



## Wąż ogrodowy

Garden hose / Gartenschlauch / Шланг садовий / Шланг садовий / Kerti tömlő / Furtun de gradina / Zahradní hadice / Záhradná hadica / Vrtna cev / Sodo žarna / Dārza šļūtene / Aiavoolik / Градински маркуч / Crijevo za vrt / Baštensko crevo / Λάστικο κήπου / Manguera de jardín / Tubo da giardino / Tuinslang

**NEO**  
TOOLS

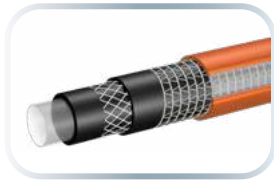

Ref.	Ø ["]	L [m]	☒	EAN
15-840	1/2	20	0/1	5907558444483
15-841	1/2	30	0/1	5907558444490
15-842	1/2	50	0/1	5907558444506
15-843	3/4	20	0/1	5907558444513
15-844	3/4	30	0/1	5907558444520
15-845	3/4	50	0/1	5907558444537

**NEO**  
TOOLS

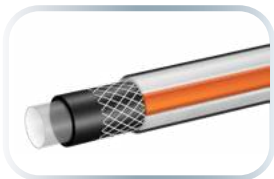

Ref.	Ø ["]	L [m]	☒	EAN
15-820	1/2	20	0/1	5907558444421
15-821	1/2	30	0/1	5907558444438
15-822	1/2	50	0/1	5907558444445
15-823	3/4	20	0/1	5907558444452
15-824	3/4	30	0/1	5907558444469
15-825	3/4	50	0/1	5907558444476

**NEO**  
TOOLS

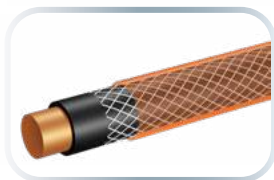

Ref.	Ø ["]	L [m]	☒	EAN
15-800	1/2	20	0/1	5907558444360
15-801	1/2	30	0/1	5907558444377
15-802	1/2	50	0/1	5907558444384
15-803	3/4	20	0/1	5907558444391
15-804	3/4	30	0/1	5907558444407
15-805	3/4	50	0/1	5907558444414

## VERTO

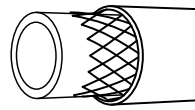

Ref.	Ø ["]	L [m]	☒	EAN
15G820	1/2	20	0/1	5902062039309
15G821	1/2	30	0/1	5902062039316
15G822	1/2	50	0/1	5902062039323
15G823	3/4	20	0/1	5902062039330
15G824	3/4	30	0/1	5902062039347
15G825	3/4	50	0/1	5902062039354

## VERTO

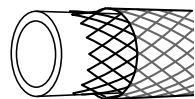

Ref.	Ø ["]	L [m]	☒	EAN
15G800	1/2	20	0/1	5902062039309
15G801	1/2	30	0/1	5902062039316
15G802	1/2	50	0/1	5902062039323
15G803	3/4	20	0/1	5902062039330
15G804	3/4	30	0/1	5902062039347
15G805	3/4	50	0/1	5902062039354

## Wąż ogrodowy rozciągliwy

Flexible garden hose / Garten-Streckschlauch / Шланг садовий розтягнуваний / Шланг садовий, що розтягується / Rugalmas kerti tömlő / Furtun de grădină extensibil / Elastická zahradní hadice / Záhradná pružná hadica / Raztegljiva vrtna cev / Sodo žarna, iššitepianti / Izstiepjamā dārza šļūtene (izplešas laistšanas laikā) / Pikendatav aiavoolik / Разтегательный градински маркуч / Elasticno vrtno crijevo / Elasticno baštensko crevo / Λάστικο ποτίματος επεκτεινόμενο / Manguera de jardín flexible / Tubo elastico da giardino

## VERTO

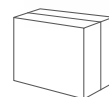
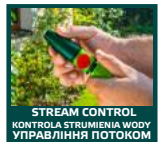

Ref.	L [m]	☒	EAN
15G890	7,5 - 22,5	0/8	5902062054401



## Wąż kroplujący

Soaker hose / Sprühschlauch / Шланг для капельного полива / Шланг для капельного полива / Csepgetető tömlő / Furtun de irigare prin picurare / Průsaková porézni zavlažovací hadice / Кваркация hadica / Kapljalna cev / Lašinio laistymo žarna / Pilienu šļūtene / Tilkkoolik / Маркуч за напукване / Сријево за navodnjavanje kap po kap / Cev prskalica / Σωλήνας άβρευσής / Manguera de goteo / Tubo per irrigazione / Mangueira de gotejamento / Tube goutte-à-goutte / Druppel slang

**NEO**  
TOOLS



15  
m

Ø  
1/2"

Ø13  
mm

8  
bar  
max



Ref. 15-880    Info 0/12    EAN 5907558464368

## Wąż z automatycznym zwijaczem

Hose with automatic retractor / Schlauch mit automatischem Retraktor / Шланг с автоматическим втягивающим устройством / Шланг с автоматичним втягувачем / Tömlő automatikus visszahúzóval / Furtun cu retractor automat / Hadice s automatickým navíječem / Hadica s automatickým navijačom / Cev z avtomatskim navijalom / Žarna su avtomatiniu (traukikliu) / Šļūtene ar avtomātisko spriegotāju / Automaatse tõtburiga voolik / Маркуч с автоматично прибиращо устройство / Сријево s avtomatskim uvlačiteljem / Црево са аутоматским увлачачем / Σωλήνας με αυτόματο συσπειρωτήρα / Manguera con retractor automático / Tubo con riavvolgitore automatico / Mangueira com retrator automático / Tuyau avec enrouleur automatique / Slang met automatisch oprolmechanisme

**NEO**  
TOOLS



20m  
+2m

auto  
roll-up

1/2"

180°

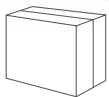

Ref. 15-891    Info 0/1    EAN 5907558451313

## VERTO



HOSE STOP  
AUTOMATYCZNA BLOKADA  
АВТОМАТИЧНА БЛОКАДА



NOZZLE AND CONNECTORS INCLUDED  
Z DYŠZĄ I ZŁĄCZAMI  
СОПЛО І РОЗ'ЄМИ В КОМПЛЕКТІ

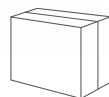

Ref. 156891    Info 1/2", 20+2m    Info 0/1    EAN 5902062507945

## Składany pojemnik na deszczówkę

Collapsible rainwater storage container / Zusammenlegbarer Regenwasser-Sammelbehälter / Складной контейнер для хранения дождевой воды / Розбірний контейнер для зберігання дощової води / Összecsukható esővíztároló tartály / Recipient pliabil pentru depozitarea apei de ploaie / Skládací nádoba na dešťovou vodu / Skladacia nádoba na dažďovú vodu / Zložitljiva posoda za deževnico / Sulankstoma lietaus vandens talpykla / Salokāms lietus ūdens uzglabāšanas konteiners / Kokkupandav vihmavee mahuti / Създаем контейнер за съхранение на дъждовна вода / Sklopiva posuda za kišnicu / Складуви контейнер за кишницу / Αναδιπλούμενο δοχείο αποθήκευσης βρόχινου νερού / Recipiente plegable para almacenar agua de lluvia / Contenitore pieghevole per l'acqua piovana / Recipiente para armazenamento de água da chuva dobrável / Conteneur pliable pour le stockage de l'eau de pluie

**NEO**  
TOOLS

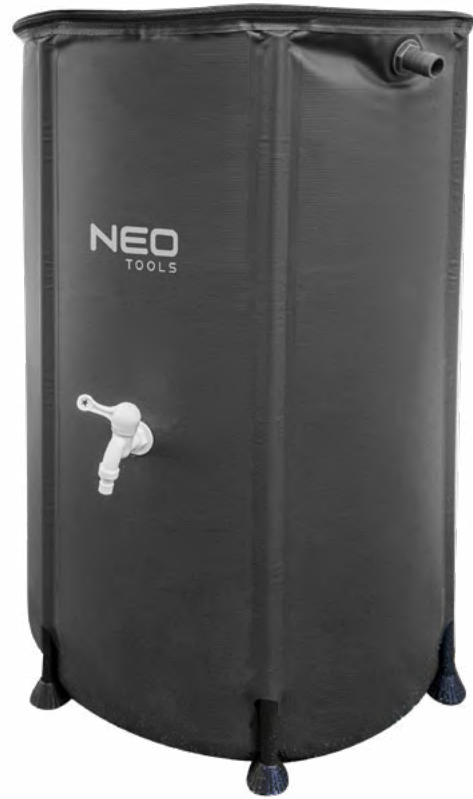

PVC

LIGHT  
WEIGHT

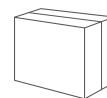

Ref.	V [l]	Ø [cm]	H [cm]	Info	EAN
15-950	100	40	78	0/6	5907558485370
15-951	250	60	88	0/6	5907558485387
15-952	500	80	98	0/6	5907558485394



## Sekator ogrodowy

Garden pruner / Gartenschere / Секатор садовый / Секатор садовый / Metszőolló / Foarfeca de gradina / Zahradnické nůžky / Nožnice záhradnícke / Vrtné škarje / Sodo sekatorius / Dārza grieznes / Oksakäärid / Ножница лозарска / Škare za obrezivanje / Makaze za orezivanje / Ψαλίδι κλαδέματος / Tijeras de jardín / Cesoia da giardino / Podadeira para jardim / Sécateur de jardin / Tuintakkschaar

**NEO**  
TOOLS



Ref. 15-200 EAN 10/60 5907558464757

**NEO**  
TOOLS



Ref. 15-201 EAN 10/60 5907558464764

**NEO**  
TOOLS

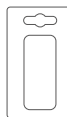

Ref. 15-202 EAN 10/60 5907558464771

**NEO**  
TOOLS

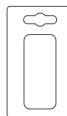

Ref. 15-204 EAN 10/60 5907558464795

**NEO**  
TOOLS

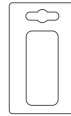

Ref. 15-203 EAN 10/60 5907558464788

**NEO**  
TOOLS

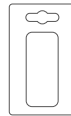

Ref. 15-208 EAN 10/60 5907558464818

**NEO**  
TOOLS

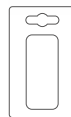

Ref. 15-211 EAN 12/48 5907558484632

**NEO**  
TOOLS

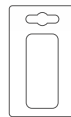

Ref. 15-213 EAN 12/48 5907558484656

**NEO**  
TOOLS

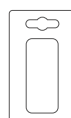

Ref. 15-207 EAN 10/100 5907558464801



## Sekator ogrodowy

Garden pruner / Gartenschere / Секатор садовий / Секатор садовий / Metszőolló / Foarfeca de gradina / Zahradnické nůžky / Nožnice záhradnicke / Vrtné škarje / Sodo sekatorius / Dārza grieznes / Oksakääräd / Ножуца лозарска / Škare za obrezivanje / Makaze za orezivanje / Ψαλίδι κλαδέματος / Tijeras de jardín / Cesoia da giardino / Podadeira para jardim / Sécateur de jardin / Tuintakkschaar

NEO  
TOOLS

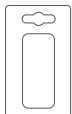

Ref. 15-210  
Info 12/48  
EAN 5907558484625

NEO  
TOOLS

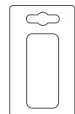

Ref. 15-212  
Info 12/48  
EAN 5907558484649

## VERTO

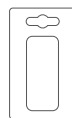

Ref. 156200  
Info ø max 10 mm  
Info 12/72  
EAN 5902062036995

## VERTO

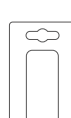

Ref. 156202  
Info ø max 12 mm  
Info 12/72  
EAN 5902062037015

## VERTO

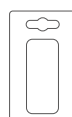
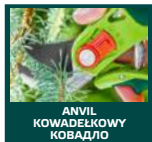

Ref. 156203  
Info ø max 12 mm  
Info 12/72  
EAN 5902062037022

## VERTO

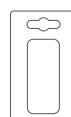
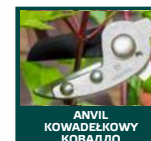

Ref. 156201  
Info ø max 10 mm  
Info 12/72  
EAN 5902062037008

## VERTO

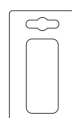

Ref. 156206  
Info ø max 18 mm  
Info 12/72  
EAN 5902062037053

## VERTO



Ref. 156205  
Info ø max 20 mm  
Info 12/72  
EAN 5902062037046



## Sektor ogrodowy

Garden pruner / Gartenschere / Секатор садовий / Секатор садовий / Metszőolló / Foarfeca de gradina / Zahradnické nůžky / Nožnice záhradnícke / Vrtne škarje / Sodo sektorius / Dārza grieznes / Oksakäärid / Ножниця лозарска / Škare za obrezivanje / Makaze za orezivanje / Ψαλίδι κλαδέματος / Tijeras de jardín / Cesoia da giardino / Podadeira para jardim / Sécateur de jardin / Tuintakkschaar

**VERTO**



Ref.	Info	⊠	EAN
156207	∅ max 18 mm	12/72	5902062037060

**VERTO**



Ref.	Info	⊠	EAN
156204	∅ max 15 mm	10/60	5902062037039

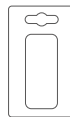
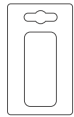

## Nożyczki

Scissors / Schere / Ножницы / Ножниця / Olló / Foarfeca / Nůžky / Nožnice / Škarje / Žirkles / Šķēres / Tijeras / Ножниця / Škare / Маказе / Ψαλίδι / Käärid / Forbici

**NEO TOOLS**



Ref.	⊠	EAN
15-215	12/72	5907558464825

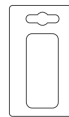

## Sektor do gałęzi

Lopping shears / Astschere / Сучкорез / Сучкоріз / Ágvágó olló / Foarfeca de gradina / Zahradnické nůžky na větve / Nožnice na konáre / Škarje za obrezovanje vej / Sektorius šakoms / Grieznes zariem / Kärpimiskäärid / Ножниця за клоны / Škare za grane / Makaze za grane / Ψαλίδι κλαδέματος / Tijeras de podar / Cesoia per rami / Poadeira de ramos / Sécateur à branches / Takkenschaar

**NEO TOOLS**

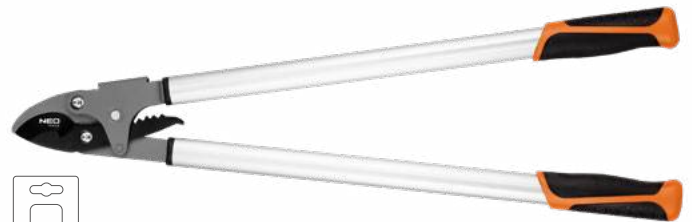

Ref.	⊠	EAN
15-251	0/12	5907558464849



## Sektor do gałęzi

Lopping shears / Astschere / Сучкорез / Сучкоріз / Ágvágó olló / Foarfeca de gradina / Zahradnické nůžky na větve / Nožnice na konáre / Škarje za obrezovanje vej / Sektorius šakoms / Grieznes zariem / Kärpimiskäärid / Ножниця за клоны / Škare za grane / Makaze za grane / Ψαλίδι κλαδέματος / Tijeras de podar / Cesoia per rami / Poadeira de ramos / Sécateur à branches / Takkenschaar

**NEO TOOLS**



Ref.	⊠	EAN
15-250	0/12	5907558464832

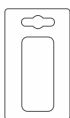

**NEO TOOLS**



Ref.	⊠	EAN
15-254	0/12	5907558464870

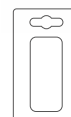

**NEO TOOLS**



Ref.	⊠	EAN
15-252	0/12	5907558464856

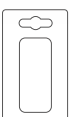

**NEO TOOLS**



Ref.	⊠	EAN
15-253	0/12	5907558464863





## Sektor do gałęzi

Lopping shears / Astschere / Сучкорез / Сучкоріз / Άγνάγο ολλό / Foarfeca de gradina / Zahradnické nůžky na větve / Nožnice na konáre / Škarje za obrezovanje vej / Sekatorius šakoms / Grieznes zariem / Kärpimiskärid / Ножница за клопи / Škare za grane / Makaze za grane / Φαλίδρα κλαδέματος / Tijeras de podar / Cesoia per rami / Poadeira de ramos / Sécateur à branches / Takkenschaar

**VERTO**



Ref.	Info	☒	EAN
15G255	ø max 30 mm	0/12	5902062037138

**VERTO**



Ref.	Info	☒	EAN
15G253	ø max 35 mm	0/6	5902062037114

**VERTO**



Ref.	Info	☒	EAN
15G258	ø max 45 mm	0/12	5902062037169

**VERTO**



Ref.	Info	☒	EAN
15G259	ø max 45 mm	0/12	5902062037176

**VERTO**



Ref.	Info	☒	EAN
15G256	ø max 42 mm	0/12	5902062037145

**VERTO**



Ref.	Info	☒	EAN
15G257	ø max 42 mm	0/12	5902062037152

**VERTO**



Ref.	Info	☒	EAN
15G250	ø max 30 mm	6/12	5902062037084

**VERTO**



Ref.	Info	☒	EAN
15G251	ø max 35 mm	6/12	5902062037091



## Sektor do gałęzi

Lopping shears / Astschere / Сучкорез / Сучкоріз / Άγνάγο ολλό / Foarfeca de gradina / Zahradnické nůžky na větve / Nožnice na konáre / Škarje za obrezovanje vej / Sekatorius šakoms / Grieznes zariem / Kärpimiskäärid / Ножница за клопи / Škare za grane / Makaze za grane / Ψαλίδα κλαδέματος / Tijeras de podar / Cesoia per rami / Podadeira de ramos / Sécateur à branches / Takkenschaar

**VERTO**



Ref.	Info	⊠	EAN
15G252	Ø max 35 mm	6/12	5902062037107

**VERTO**



Ref.	Info	⊠	EAN
15G254	Ø max 30 mm	0/12	5902062037121

## Sektor z piłą

Saw pruner / Baumschere mit säge / Секатор с пилой / Секатор з пилкою / Άγνάγο fűrészszel / Foarfecă cu piľă / Zahradní nůžky s pilkou / Nožnice s pilou / Škarje z žago / Sekatorius su pjūkleliu / Dārza grieznes ar zāģi / Lāikur koos saega / Градинарски ножници с трупон / Vrtné škare s pilom / Baštenske makaze sa pilom / Ψαλίδι με πριόνι / Tijeras podaderas con sierra / Svettaioio a pertica con segaccio tagliarami / Podadeira de fita / Sécateur à chenilles / Snoeischaar

**VERTO**



Ref.	Info	⊠	EAN
15G260	Ø max 30 mm	0/10	5902062037183

## Trzonek teleskopowy

Telescopic handle / Teleskopstiel / Штанга телескопическая / Штанга телескопична / Teleszkópos nyél / Manivelă telescopică / Teleskopická násada / Rukoväť teleskopická / Teleskopski ročaj / Teleskopinė rankena / Teleskopisks rokturis / Teleskoopkæepide / Телескопична дръжска / Teleskopska drška / Teleskopska drska / Τηλεσκοπικό κονταροπριόνιο / Mango telescópico / Zoccolo telescopico / Cabo telescópico / Manche telescopique / Telescopisch handvat

**VERTO**

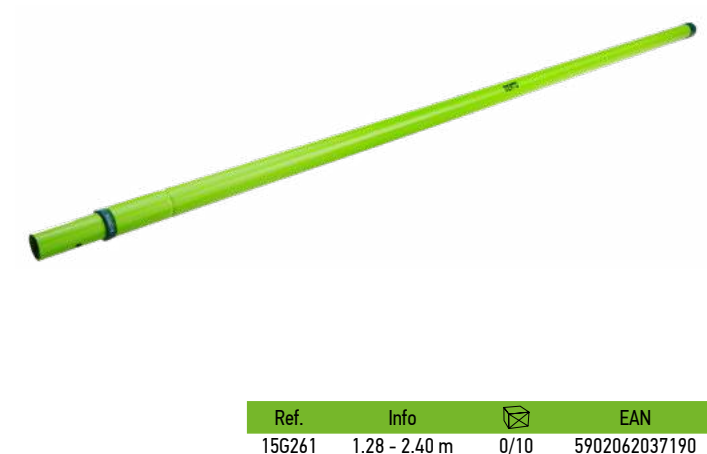

Ref.	Info	⊠	EAN
15G261	1.28 - 2.40 m	0/10	5902062037190

## Nožyce do trawy

Grass shears / Grasschere / Ножницы газонные / Ножници газонні / Fűszegélyvágó olló / Foarfeca gazon / Nůžky na trávník / Nožnice na trávu / Škarje za travo / Žirkles žolei / Grieznes zālājam / Rohukäärid / Ножница за трева / Škare za travu / Makaze za travu / Ψαλίδι για γρασιδι / Forbici per erbe / Tesoura para relva / Cisaille à gazon / Grasscharen

**VERTO**

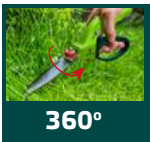

Ref.	Info	⊠	EAN
15G300	360°	10/60	5902062037374

**VERTO**

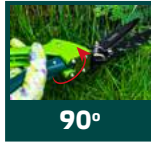

Ref.	Info	⊠	EAN
15G301	90°	12/60	5902062037381

**VERTO**

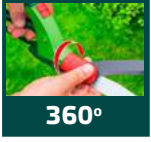

Ref.	Info	⊠	EAN
15G302	360°	12/72	5902062037398



## Nożyce do żywopłotu

Hedge shears / Heckenscherer / Ножницы для живой изгороди / Ножницы до живооплоту / Sövénynyágó olló / Foarfece grădină / Nůžky na živý plot / Nožnice na živý plot / Škarje za živo mejo / Žirkles gyvatvorei / Grieznes krūmiem / Hekikäärid / Ножница за храсти / Skare za živu ogradu / Makaze za živu ogradu / Ψαλίδι για φράκτη από θάμνους / Cortasetos eléctrica / Forbici per siepe / Tesoura p. vedação / Cisaille à haie /



STRAIGHT BLADES  
OSTRZA PROSTE  
ПРЯМІ ЛЕЗА



ERGONOMIC SHAPE  
ERGONOMICZNY KSZTAŁT  
ЕРГОНОМІЧНА ФОРМА

**VERTO**

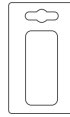

Ref.	Info	⊠	EAN
15G310	185 mm	6/12	5902062037404



WAVY BLADES  
OSTRZA FALOWANE  
ЛЕЗА ХВИЛЯСТІ



ERGONOMIC SHAPE  
ERGONOMICZNY KSZTAŁT  
ЕРГОНОМІЧНА ФОРМА

**VERTO**

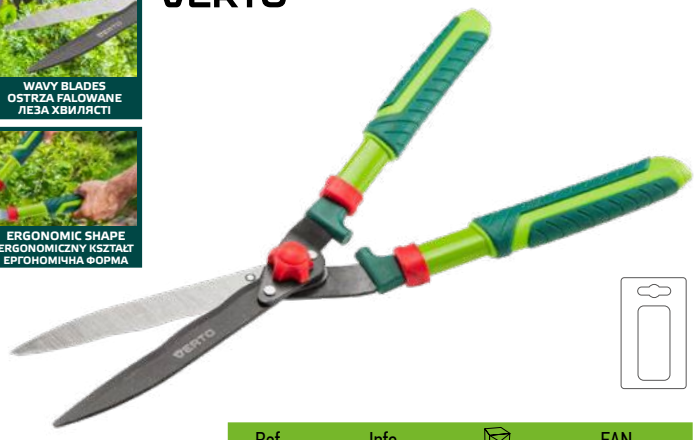

Ref.	Info	⊠	EAN
15G311	200 mm	6/12	5902062037411



WAVY BLADES  
OSTRZA FALOWANE  
ЛЕЗА ХВИЛЯСТІ



TELESCOPIC 670 - 880 MM  
TELESKOPOWY 670 - 880 MM  
ТЕЛЕСКОПІЧНИ 670 - 880 MM

**VERTO**

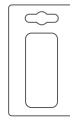

Ref.	Info	⊠	EAN
15G312	200 mm	6/12	5902062037428



POWER +30%  
MOC +30%  
МІЦЬ +30%



BIMATERIAL  
DWUMATERIAŁOWY  
ДВОКОМПОНЕНТНИЙ

**VERTO**

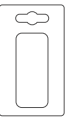

Ref.	Info	⊠	EAN
15G313	210 mm	0/12	5902062037435

## Kosiarka ręczna

Hand lawn mower / Hand-rasenmäher / Ручная газонокосилка / Ручна газонокосарка / Kézi fűnyíró / Mašinā de tuns iarba / Ruční sekačka / Ručná kosačka / Ročna kosilnica / Rankinė vejarpjovė / Rokas žaless plāvējs / Rokas žaless plāvējs / Ръчна косачка / Ручна косилка / Ручна косилка / Хортокопачка μηχανη χειρών / Cortacésped manual / Tagliaerba a mano / Cortador de grama manual / Tondeuse à gazon à main / Hand grasmaaier /

**VERTO**



ADJUSTABLE HEIGHT 12-45 MM  
REGULOWANA WYSOKOŚĆ 12-45MM  
РЕГУЛЬОВАНА ВИСОТА 12-45 MM



BASKET 16L  
KOSZ 16L  
КОРЗИНА 16L

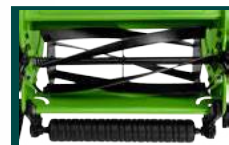

CUTTING WIDTH 300 MM  
SZEROKOŚĆ KOSZENIA 300 MM  
ШИРИНА РІЗАННЯ 300 MM



LIGHT WEIGHT 7KG  
NISKA WAGA 7KG  
НЕВЕЛИКА ВАГА 7 КГ

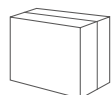

Ref.	⊠	EAN
15G350	0/1	5902062085610



## Piła ogrodowa

Saw / Gartensäge / Пила садова / Пилка садова / Ágvágófűrész / Ferestrău / Zahradní pilka / Pilka záhradkárska / Žaga / Pjüklas / Zägjis / Saag / Τριων / Pila / Testera / Αλυσοπίοιο / Sega per frutteto / Serra agrícola / Scie de jardin / Boomzaag

**NEO**  
TOOLS



Ref. EAN  
42-100 5907558463637

**NEO**  
TOOLS



Ref. EAN  
42-101 6/24 5907558463644

**NEO**  
TOOLS



Ref. EAN  
42-102 6/24 5907558463651

**VERTO**

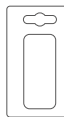
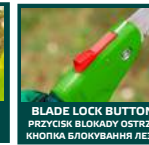
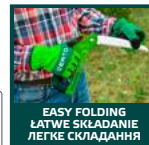
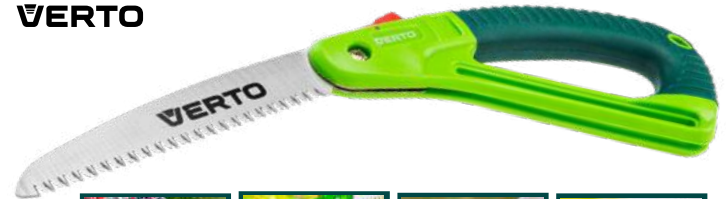

Ref. L [mm] EAN  
15G100 180 0/20 5902062038210

**VERTO**

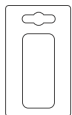

Ref. L [mm] EAN  
15G101 350 0/20 5902062038227



**VERTO**



Ref. L [mm] EAN  
15G102 450 6/24 5902062038234

**TOP TOOLS**



Ref. L [mm] EAN  
10A750 180 20/60 5902062038609



## Piła kabląkowa

Bow saw / Bogensäge / Ножовка лучковая / Ножівка лучкова / Fűrész keretes / Ferestrău cu arc / Oblouková píla / Pílka rámová / Žaga lokarica / Pjūklas rēminis / Lokzāģis / Vibusaag / Трион бичкия / Pila za drvo / Testera za drvo / Τοξοπίλοιο / Sierra de arco / Segá ad arco / Serra de arco / Scie à archet / Boogzaag

**VERTO**



Ref.	L [mm/"]	☒	EAN
15G155	760/30	12/24	5902062050489
15G156	910/36	0/12	5902062050861

**TOPEX**



Ref.	L [mm/"]	☒	EAN
10A903	300	6/24	5902062102089
10A905	530	0/12	5902062101860
10A906	610	0/12	5902062101822
10A907	910	0/12	5902062101839

## Brzeszczot do piły kabląkowej

Blade for bow saw / Sägeblatt für Bogensäge / Полотно для лучковой пилы / Полотно до пилки лучкової / Lap keretesfűrészhez / Pânză pentru ferestrău cu ramă / Pilový list pro obloukovou pílu / Čepel oblúčovej píly / Žagni list za ločno žago / Geležje, lenkntam pjuklui / Lokzāģa asmens / Vibusae saeleht / Лента за лъков трион / Oštrica za ručnu pílu / Sečiva za lučnu testeru / Приονόλαμα για τοξοειδές πριόνι / Hoja de sierra de arco / Lama per sega ad arco / Lâmina p. Serra / Lame de scie pour scie à archet / Mesblad voor boogzaag

**TOPEX**



Ref.	L [mm]	☒	EAN
10A915	530	0/240	5902062101938
10A916	610	0/240	5902062101945
10A917	760	0/240	5902062101952

## Maczeta ogrodowa

Garden machete / Gartenmachete / Мачете для садових работ / Мачете садовий / Kerti bozótvágo / Macetă de grădină / Zahradní mačeta / Záhradná mačeta / Vrtna mačeta / Mačete sodui / Dārza mačete / Aiamaťseete / Градинско мачете / Маčета за крчење / Маčета за rastinje / Ματσετα κήπου / Machete de jardineria / Machete da giardino / Machete de jardim / Manchette de jardin / Kapmes /

**VERTO**

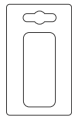

Ref.	L ["]	☒	EAN
15G191	18	0/48	5902062050755

**VERTO**

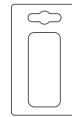

Ref.	L ["]	☒	EAN
15G190	19	0/48	5902062050748

## Siekiera

Axe / Axt / Топор / Сокура / Balta / Topor / Sekera / Sekera / Sekira / Kirvis / Cirvis / Kirves / Брадва / Sjekira / Sekira / Τσεκούρι / Hacha / Ascia / Machado / Hache / Bijl

**NEO TOOLS**

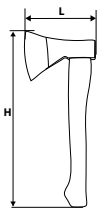

Ref.	m [g]	H [mm]	L [mm]	☒	EAN
27-006	600	360	145	6/24	5907558400489
27-008	800	380	165	6/24	5907558400496
27-010	1000	400	175	6/12	5907558400502

**NEO TOOLS**



Ref.	m [g]	H [mm]	L [mm]	☒	EAN
27-012	1250	700	195	4/8	5907558400519

**NEO TOOLS**



Ref.	m [g]	H [mm]	L [mm]	☒	EAN
27-019	2000	700	195	0/4	5907558407341

**NEO TOOLS**



Ref.	m [g]	H [mm]	L [mm]	☒	EAN
27-030	400	355	120	12/24	5907558431377
27-031	700	445	140	6/12	5907558431384
27-032	850	600	160	6/12	5907558431391



## Siekiera

Axe / Axt / Topor / Сокрупа / Balta / Topor / Sekera / Sekera / Sekira / Kirvis / Cirvis / Kirves / Брадава / Sjekira / Sekira / Ταξκούρι / Hacha / Ascia / Machado / Hache / Bijl

**NEO**  
TOOLS

28" 2200g 1700g FIBER



Ref.	m [g]	H [mm]	L [mm]	☒	EAN
27-033	1700	710	185	4/8	5907558431407

**NEO**  
TOOLS

**EXTREME**



fiberglass HANDLE  
FIB-MATERIAL  
DIN 5131

Ref.	m [g]	H [mm]	L [mm]	☒	EAN
27-120	600	140	367	6/24	5907558454840
27-121	800	162	370	6/24	5907558454857
27-123	1250	195	868	0/12	5907558454871
27-124	1500	195	880	0/12	5907558454888

## VERTO



Ref.	L ["]	m1 [g]	m2 [g]	☒	EAN
05G102	9"	550	410	6/24	5902062050496
05G100	14"	620	410	0/20	5902062037671
05G101	17,5"	870	540	0/20	5902062038562
05G103	28"	1350	800	4/8	5902062050588
05G104	28"	1510	1000	4/8	5902062050595

## VERTO



Ref.	L [mm]	m1 [g]	m2 [g]	☒	EAN
05G201	370	860	600	4/16	5902062038579

## VERTO



Ref.	L [mm]	m1 [g]	m2 [g]	☒	EAN
05G202	880	2500	1500	0/4	5902062038586

## VERTO



Ref.	L [mm]	m1 [g]	m2 [g]	☒	EAN
05G203	880	3900	2700	0/2	5902062038593

## TOPEX

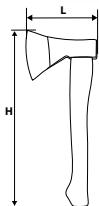

Ref.	m [g]	H [mm]	L [mm]	DIN	☒	EAN
05A136	600	360	150	5131	0/24	5902062103314
05A138	800	380	165	5131	6/24	5902062103321
05A140	1000	610	180	5131	0/12	5902062103338
05A142	1250	710	200	7294	0/12	5902062103345
05A146	1600	810	215	7294	0/8	5902062103352

## TOPEX



fiberglass  
HANDLE

Ref.	m [g]	H [mm]	L [mm]	DIN	☒	EAN
05A220	600	144	377	5131	6/24	5902062510112
05A221	800	160	401	5131	6/18	5902062510129
05A222	1000	172	450	5131	0/6	5902062510150
05A223	1250	184	860	5131	0/6	5902062510167

## TOPEX



Ref.	m [g]	H [mm]	L [mm]	☒	EAN
05A148	2000	800	200	0/6	5902062032065



## Siekiera

Axe / Axt / Topor / Сокира / Balta / Topor / Sekera / Sekera / Sekira / Kirvis / Cirvis / Kirves / Брадва / Sjekira / Sekira / Τσεκούρι / Hacha / Ascia / Machado / Hache / Bijl



Ref.	m [g]	☒	EAN
05A306	600	0/24	5902062100436
05A308	800	0/12	5902062104618
05A310	1000	0/12	5902062100849
05A312	1250	0/12	5902062100443



Ref.	m [g]	☒	EAN
05A206	600	0/20	5902062101334
05A208	800	0/12	5902062104595
05A210	1000	0/12	5902062104601
05A212	1250	0/10	5902062101341

## Młoto-siekiera

Splitting maul / Hammer-Axt / Κοπυρ / Сокира з довшим ручкі'ям / Fejsze / Topor pentru despicat / Kladivová sekera / Kladivová sekera / Kladivo-sekira / Plaktukas-kirvis / Cirvis skaldīšanai / Haamriiga kirves / Чук-брадва / Čekič-sjekira / Čekič-sekira / Τσεκούρι τεμαχισμού / Martillo-hacha / Ascia / Martelo-Machado / Hache-marteau / Hamer-bijl



Ref.	m [g]	H [mm]	L [mm]	☒	EAN
27-050	2500	900	200	0/4	5907558409901

## Toporek uniwersalny

Hatchet / Universalbeil / Toporик универсальный / Сокира универсальна / Gipszvágóbalta / Toporasz / Sekerka univerzální / Sekerka tesárska / Sekira / Universalus kirvis / Cirvis universāls / Kirves / Чук-брадва / Čekič-Sjekira / Sekira / Πελέκι γενικής χρήσης / Hacha universal / Ascia / Machada universal / Merlin universal / Universele handbijl



Ref.	m [g]	H [mm]	L [mm]	☒	EAN
02A110	600	323	173	6/24	5902062102621

## Trzonek

Shank / Stiel / Ручьятка / Хвостовик / Baltanyél / Mânier / Násada / Trň / Ročaj / Kotas / Spals / Vars / Цокль / Držak / Drška, držalo / Χειρολαβή / Vástago / Manico per ascia / Cabo / Manche / Handvat



Ref.	do siekier	L [mm]	☒	EAN
05A436	600g	360	0/50	5902062948700
05A450	800g	500	0/25	5902062948717
05A460	1000g	600	0/25	5902062948724
05A470	1250g	700	0/25	5902062948731

## Klin

Wedge / Keil / Клин / Клин / Ёк / Pană / Klín / Klin / Klin / Pleištas / Қіліс / Киіл / Клин / Klin / Klin / Σφήνα / Cuña / Cuneo / Cunha / Cale / Wig



Ref.	m [g]	L ["]	☒	EAN
27-201	100	5,5	50/100	5907558468151
27-202	200	8	20/40	5907558468168
27-203	300	10	20/40	5907558468175



ALUMINIUM

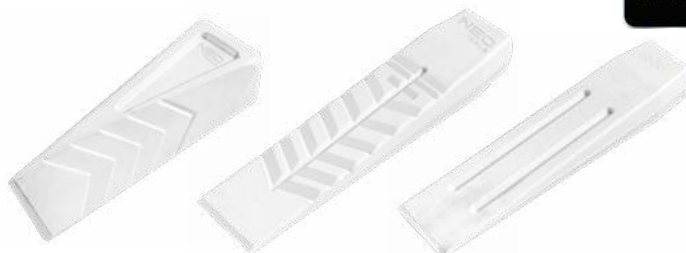

Ref.	m [g]	☒	EAN
27-211	800	0/20	5907558468205
27-212	800	0/20	5907558468199
27-213	550	0/40	5907558468182

## Ostrzałka do noży i nożyczek

Knife and scissor sharpener / Rasentmäher-Messerschärfer / Точилка для ножей и ножниц / Точилка для ножиц и ножниц / Élező késekhez és ollókhöz / Dispozitiv de ascuțit cuțite și foarfeci / Ostrič nožu a nůžek / Brúsič na nože a nožnice / Brusilec nožev in škarij / Peilių ir žirklių galastuvas / Asināmais nažiem un šķērēm / Nugade ja kāāride teriģa / Точило за ножове и ножници / Oštrilica za noževe i škare / Oštrilica za noževe i makaze / Ακονιστήρι μαχαιριών και ψαλιδιών / Afilador de cuchillos y tijeras / Affilatrice per coltelli e forbici / Afijador de faca e tesoura / Aiguiseur pour couteaux et ciseaux / Messenslijper

## VERTO



Ref.	☒	EAN
05G120	6/48	5902062997791

## Aerator sandałowy

Sandal aerator / Sandelbelüfter / Сандапөөхий аэрапор / Szandál levegőztető / Aerator pentru sandale / Provzdušňovač písku / Prevzdušňovač sandálov / Peskovni prezračevalnik / Smělo aeratorius / Smlšu aerators / Аератор за пясък / Αεριστήρας σανδάλιου / Aireador de arena / Aeratore per sandali / Arejador de sandálias / Aérateur de sable / Sandaal beluchter

## VERTO



Ref.	☒	EAN
156540	1/20	5902062092540



## Szpadel

Spade / Spaten / Заступ / Лопата багнетова / Ásó nyelezve / Lopáticã / Rýč / Rýl' lichobežníkový / Lopata / Kastuvus / Lápsta / Labidas / Лопата права / Lopata / Lopata / Φυάρι / Pala / Pala / Pá / Louchet / Spade

**NEO**  
TOOLS



Ref.	☒	EAN
95-007	0/6	5907558433623
95-008	0/6	5907558433616

## VERTO

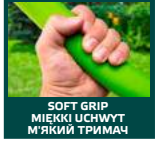

Ref.	☒	EAN
15G010	0/6	5902062038470
15G011	0/6	5902062038487

## VERTO



Ref.	☒	EAN
15G001	0/6	5902062038241
15G002	0/6	5902062038258

## VERTO



Ref.	☒	EAN
15G014	0/6	5902062050779

## VERTO



Ref.	☒	EAN
15G003	0/6	5902062038265
15G004	0/6	5902062038272

## VERTO



Ref.	☒	EAN
15G017	0/5	5902062086075





## Saperka skladana

Trenching shovel / Pionierspaten / Саперная лопата / Лопатка саперна / Ásó tábori / Lopatã micã / Rýč / Malã lopatka / Lopata / Kastuvėlis / Sapiera lãpsta / Sapõõrilabidas / Малка нехотна лопата / Lopatica / Pionirski ašov / Φτυάρι λαμού / Pala de trinchera / Pala ripiegabile / Pã pequena / Pelle à manche court

**VERTO**

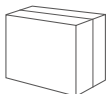
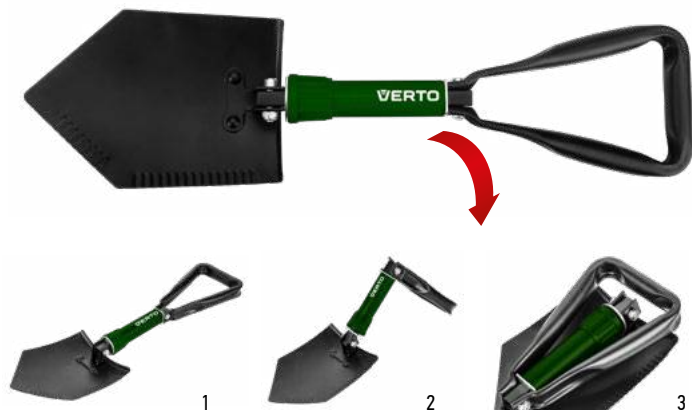

Ref.	☒	EAN
15G075	0/12	5902062089083

## Łopata piaskowa

Sand shovel / Sandspaten / Лопата совковая / Лопата совкова / Lapát nyelezett / Lopatã pentru nisip / Lopata na pisek / Lopata na piesok / Lopata za pesek / Kastuvã smėliui / Lãpsta / Liivalabidas / Лопата за пясък / Lopata za pijesak / Lopata za pesak / Φτυάρι τετράγωνο / Pala cuadrada / Pala per sabbia / Pã de rotor / Aube de rotor / Zandschep

**NEO**  
TOOLS



Ref.	☒	EAN
95-011	0/6	5907558433609

## Łopata

Shovel / Schaufel / Лопата / Лопата совковая / Lapát nyelezeve / Lopatã / Lopata / Lopata ocelovã / Lopata / Kastuvã / Lãpsta / Kùhvel / Лопата крива / Lopata / Lopata / Φτυάρι / Pala / Badile / Pã / Pelle / Schep

**VERTO**

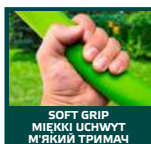

Ref.	☒	EAN
15G012	0/6	5902062038449

## Łopatka

Garden trowel / Kleiner spatel / Лопатка / Лопатка / Kislapát / Lopata pentru zapada / Lopata na snih / Lopata na sneh / Lopata za sneg / Kastuvã sniegui / Lãpsta sniegam / Lumelabidas / Лопатка / Lopatica / Lopata za sneg / Φτυάρι για το χιόνι / Hombro / Spalla / Ombro / L'épaule / Schepje

**VERTO**



Ref.	L [mm]	☒	EAN
15G405	340	6/36	5902062037442
15G406	350	6/36	5902062037459

## Pazaruki

Hand cultivator / Handkultivator / Тяпка посадочная / Розпушувач / Talajlazító / Cultivator / Kypřič / Kultivátor / Zubový / Kultivator / Purentuvã / Kultivãtors / Kultivaator / Κυλληματορ εργαδικοσ / Kultivator / Kultivator / Φρεζάρτρο / Rastrillo pequeño / Coltivatore / Garras / Griffes / Kweker

**VERTO**



Ref.	L [mm]	☒	EAN
15G408	365	6/36	5902062037442

## Grabki

Small rake / Kleiner rechen / Грабелъки / Грабелъки / Gereblye mini / Greblã / Hrable / Hrabličky / Grabljice / Grėbliukas / Grãbeklis / Reha / Градинарско зребло / Grablje / Grabljice / Τσουγκράνα / Rastrillo / Rastrellino / Forquilha / Petit râteau

**VERTO**



Ref.	L [mm]	☒	EAN
15G407	340	6/36	5902062037466

## Grabie do liści

Garden rake / Laubbesen / Грабли для листьев / Грабли садови / Lombseprű / Grebla gradina / Hrabě na listí / Hrable na listie / Grablje za listje / Grėblys lapams / Grãbeklis lapãm / Aiareha / Гребло градинско / Grablje za lišće / Grabulje / Τσουγκράνα για μάξμα φύλλων κηπου / Rastrello per foglie / Forquilha p. folhas / Râteaux à feuilles / Bladhark

**VERTO**



Ref.	L [cm]	☒	EAN
15G053	164	0/1	5902062045348



## Grabie

Rake / Rechen / Грабли / Грабни / Gereblye / Greblä / Hrábě / Hrable / Grablje / Gräblys / Gräbeklis / Reha / Гребло / Grablje / Grablje / Τσουγκράνα / Rastrillo / Rastrello / Ancinho / Râteaux / Hark

**VERTO**



Ref.	L [cm]	☒	EAN
156050	132	0/1	5902062045379

**VERTO**



Ref.	L [cm]	☒	EAN
156052	123	0/20	5902062045423

**VERTO**



Ref.	L [cm]	☒	EAN
156051	166	0/1	5902062045386

## Motyczka

Small hoe / Handhacke / Тяпка / Сапка / Últeló kapra / Грабля / Motyčka / Motyčka / Motika / Каптукас / Карпіс / Kõblas / Мотична градинска / Motika / Motika / Τοάνα / Zappa / Enxada / Houlette / Schöffel

**VERTO**



156409

156410

Ref.	L [mm]	☒	EAN
156409	340	6/36	5902062037480
156410	340	6/36	5902062037572

## Motyka

Hoe / Handhacke / Мотыжна / Сапка / Кара / Särälligä / Motyka / Motyčka / Motika / Purentuvas / Карпіс / Kõblas / Мотика / Motika / Motičica / Σκαλιστήρι / Azada / Zappetta / Enxada / Brosse à joints

**VERTO**



Ref.	L [cm]	☒	EAN
156030	120	0/1	5902062045362

**VERTO**

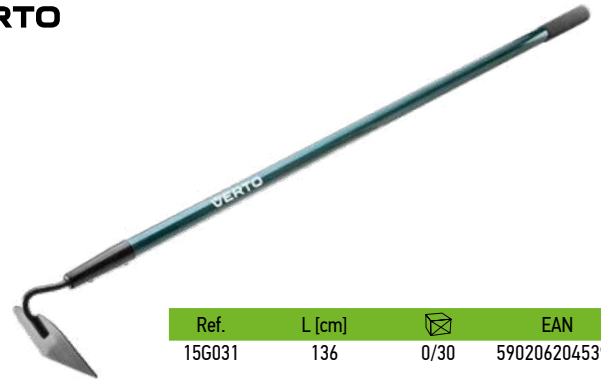

Ref.	L [cm]	☒	EAN
156031	136	0/30	5902062045393

## Widły

Fork / Gabel / Вилы / Вула / Vasvilla / Furcä / Vidle / Vidly záhradnicke / Vile / Šakės / Dakšas / Hark / Buna / Vile sa štílom / Vile / Δίκρανο / Forca / Forcado / Fourche / boormachine zonder slag

**VERTO**

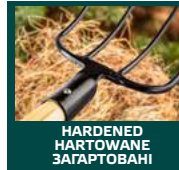

HARDENED  
HARTOWANE  
ЗАРПТОВАНИ



SOFT GRIP  
МІЄККІ УСХВУТ  
М'ЯКИЙ ТРИМАЧ

Ref.	L [cm]	☒	EAN
156040	127	0/6	5902062045409

**VERTO**



DURABLE  
WYTRZYMAŁY  
МІЦНИЙ



SOFT GRIP  
МІЄККІ УСХВУТ  
М'ЯКИЙ ТРИМАЧ

Ref.	L [cm]	☒	EAN
156041	127	0/6	5902062045416



## Trzonek

Shank / Stiel / Рукоятка / Хвостовик / Baltanyél / Mânier / Násada / Тiй / Ročaj / Kotas / Spals / Vars / Цокъл / Držak / Drška, držalo / Χειρολαβή / Vástago / Manico per ascia / Cabo / Manche / Handvat

**VERTO**



Ref.	L [cm]	☒	EAN
156013	137	0/24	5902062050762

## Obrzeže trawnika

Lawn edges / Rasenrand / Лента газонная (поребрик) / Стрiчка бар'єрна газонна / Ágyásszegély / Margine de pajște / Okraj travníku / Obruby na trávníky / Travníski robniki / Vejós krašto juosta / Zäläja armales / Μιγυüäiris / Кант за тревна площ / Rub za travnjake / Ivičnjak za travnjake / Ταμία οριοθέτησης үкаζüв / Borde para césped / Bordi per aiuole

**VERTO**



Ref.	Info	☒	EAN
156510	10 cm x 9 m	0/24	5902062037312
156511	15 cm x 9 m	0/24	5902062037329
156512	20 cm x 9 m	0/24	5902062037336
156513	10 cm x 9 m	0/24	5902062037343
156514	15 cm x 9 m	0/24	5902062037350
156515	20 cm x 9 m	0/24	5902062037367

## Wirywacz do chwastów

Weed whacker / Unkrautstecher / Рыхлитель сорняков / Gyomirtó / Mašinä de curäfat buruieni / Šlehač na plevel / Šlahač buriny / Strojek za odstranjevanje plevela / Piktžoliq naikiklis / Nezälu plävëji / Rezačka za plevelu / Χορτοκοπτικό / Desbrozadora / Diserbante / Caçador de ervas daninhas / Fauçeuse de mauvaises herbes / Onkruidverdelger

**VERTO**



Ref.	☒	EAN
156045	0/20	5902062092571

**VERTO**



Ref.	☒	EAN
156450	1/12	5902062092564

## Drut ogrodowy

Garden wire / Gartendraht / Проволока садовая / Дрiт садовий / Kötözöñuzal / Särnä pentru grădină / Zahradní drät / Záhradný drät / Vrtna žica / Sodo viela / Därza stieples / Aiatraat / Ten gradinarcka / Vrtna žica / Baštenska žica / Σύρμα κήπου / Alambre de jardín / Filo di ferro plastificato / Arame de jardim / Fil de jardin

**VERTO**

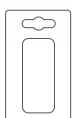

Ref.	Info	☒	EAN
156530	1.5 mm x 50 m	24/96	5902062050427

**VERTO**

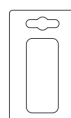

Ref.	Info	☒	EAN
156535	5 mm x 4 m	24/144	5902062050434



## Szklarnia

Оранжерия / Skleník / Gewächshaus / Θερμοκήπιο / Greenhouse / Invernadero / Serre / Üvegház / Serra / Siltnamis / Siltumnica / Serre / Estufa / Será / Парник / Skleník / Rastlinjak

**NEO**  
TOOLS



Ref.	☒	EAN
15-900	0/1	5907558485400

**NEO**  
TOOLS



Ref.	☒	EAN
15-901	0/1	5907558485417

**NEO**  
TOOLS



Ref.	☒	EAN
15-902	0/1	5907558485424

**NEO**  
TOOLS



Ref.	☒	EAN
15-910	0/1	5907558485431

**NEO**  
TOOLS



Ref.	☒	EAN
15-911	0/1	5907558485448

## Torba ogrodowa

Garden bag / Gartentasche / Садовый мешок / Мішок садовий / Kerti zsák / Sac de grădină / Brašna / Záhradná taška / Vrtna vreča / Sodo krepšys / Dārza soma / Kott / Торба / Torba / Kesa / Ταύτα κήπου / Bolsa de jardín / Bors a giardino / Saco de jardim / Sac de jardin / Tuinzak

**NEO**  
TOOLS

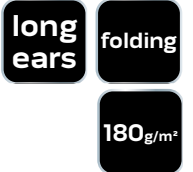

Ref.	V(L)	H [cm]	Ø [cm]	☒	EAN
15-960	85	53	46	0/15	5907558485660
15-962	170	70	55	0/12	5907558485677

**VERTO**

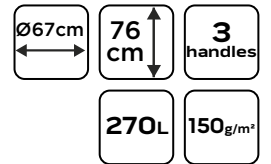

Ref.	☒	EAN
15G541	0/28	5902062093677

## Urządzenie do podwiązania roślin

Plant Tying Machine / Bindezange für Pflanzen / Устройство для подвязывания растений / Садовий стенипп / Készülék növények kötözésére / Dispozitiv pentru legarea plantelor / Zařízení pro vázání rostlin / Zariadenie na viazanie rastlín / Naprava za privezovanje rastlin / Prietaisais augalams rīsti / Ierīce augu piesiešanai / Seade taimede sidumiseks / Уред за връзване на растения / Uredaj za vezivanje biljaka / Уредж за везивање биљана / Συσκευή για δέσιμο φυτών / Dispositivo para atar plantas / Dispositivo per legare le piante / Dispositivo para amarrar plantas / Dispositif pour attacher les plantes / Apparaat om planten te binden

**VERTO**



Ref.	☒	EAN
15G455	0/20	5902062092557

## Zestaw taśm i zszywek

Set of tape and staples / Satz Klebeband und Heftklammern / Комплект из ленты и скоб / Szalag és kapcsos tűzőkapocs készlet / Set de bandă și capse / Sada pásky a sponek / Sada pásky a sponiek / Sada traku v sponke / Juostos ir segtukų rinkinys / Lentės un skavu komplekts / Комплект от лента и скобу / Σετ ταινίας και συνδετήρες / Juego de cinta y grapas / Set di nastro e punti metallici / Conjunto de fita e agrafos / Jeu de ruban adhésif et agrafes / Set van tape en nietjes

**VERTO**



Ref.	☒	EAN
15G456	0/24	5902062095497



## Gumofilce

Felt rubber boots / Filzgummistiefel / Сапоги резиновые с войлоком / Повстяни черевизи на каучуковић подоши / Filc csizma / Cizme din cauciuc cu păslă / Gumofilcové holinky / Filcové gumáky / Gumijasti škornji s filcem / Guminiai batai / Gumijas zăbaki ar filcu / Voodriga kummikud / Работни гумени ботуши с филц / Gumene cizme s filcom / Gumene cizme / Μηλότες λατιχένιες με κetaέ / Botas de agua con fieltro / Calosce con feltro / Galochas com feltro / Bottes en caoutchouc avec doublure en feutre / Rubberlaarzen

### VERTO



ANTISLIP SOLE  
ANTYPOŚLIZGOWA PODSZWA  
ΑΝΤΙΚΟΒΣΚΑ ΠΙΔΟΨΒΑ

WARMING INSERT  
OCIEPLANY WKŁAD  
ΥΤΕΠΛΗΝΑ ΥΣΤΙΛΚΑ

Ref.	size	☒	EAN
15G900	39	0/6	5902062039576
15G901	40	0/6	5902062039583
15G902	41	0/6	5902062039590
15G903	42	0/6	5902062039606
15G904	43	0/6	5902062039613
15G905	44	0/6	5902062039620
15G906	45	0/6	5902062039637
15G907	46	0/6	5902062039644
15G908	47	0/6	5902062039651

## Kalosze EVA

EVA rubber boots / Gummistiefel EVA / Галоши ЭВА / Чоботу EVA / EVA gumicsizma / Cizme cauciuc EVA / Holinky EVA / Gumáky EVA / Galoše EVA / Gmimniai batai EVA / Galošas EVA / Kummikud EVA / Гумени ботуши EVA / Gumene cizme EVA / EVA cizme za kišu / Γαλότσες από EVA / Botas de agua EVA / Calosce in EVA / Galochas de em EVA / Bottes en caoutchouc EVA / EVA Laarzen

### VERTO



ANTISLIP SOLE  
ANTYPOŚLIZGOWA PODSZWA  
ΑΝΤΙΚΟΒΣΚΑ ΠΙΔΟΨΒΑ

REPLACEMENT WARMING INSERT  
WYMIENNY WKŁAD OCIEPLANY  
ΣΜΙΝΝΑ ΥΤΕΠΛΗΝΑ ΥΣΤΙΛΚΑ

Ref.	size	☒	EAN
15G930	40	0/6	5902062039729
15G931	41	0/6	5902062039736
15G932	42	0/6	5902062039743
15G933	43	0/6	5902062039750
15G934	44	0/6	5902062039767
15G935	45	0/6	5902062039774
15G936	46	0/6	5902062039781
15G937	47	0/6	5902062039798

## Rękawice robocze

Working gloves / Arbeitshandschuhe / Перчатки рабочие / Рукaвици работчи / Bőr kesztyű / Mänuși de lucru / Pracovní rukavice / Pracovné rukavice / Delovne rokavice / Darbo pirštīnēs / Darba cimdi / Töökindad / Ръкавици работни / Radne rukavice / Radne rukavice / Γάντια εργασιών / Guantes de trabajo / Guanti di lavoro / Luvas de trabalho / Gants de travail / Werkhandschoenen

### VERTO

#### KAT II



Ref.	size	☒	EAN
97H120	8"	12/120	5902062034021
97H121	9"	12/120	5902062035486
97H122	10"	12/120	5902062035493

### VERTO

#### KAT II



Ref.	size	☒	EAN
97H136	8"	0/120	5902062054531
97H137	9"	0/120	5902062054548
97H138	10"	12/120	5902062054555

### VERTO

#### KAT II



Ref.	size	☒	EAN
97H140	7"	0/120	5902062055729
97H141	8"	0/120	5902062054517
97H142	9"	12/120	5902062054524

### VERTO

#### KAT II



Ref.	size	☒	EAN
97H151	8"	0/120	5902062039460
97H152	9"	0/120	5902062039477
97H153	10"	12/120	5902062054562

### VERTO

#### KAT II



Ref.	size	☒	EAN
97H143	7"		5902062096180
97H144	8"		5902062096197
97H145	9"		5902062096203

### VERTO

#### KAT I



Ref.	size	☒	EAN
97H146	7"	0/300	5902062096210
97H147	8"	0/300	5902062096227
97H148	9"	0/300	5902062096234



## Mata pod kolana

Knee mat / Коленный коврик / Колінний килимок / Térdszőnyeg / Mat de genunchi / Podložka pod kolena / Podložka pod kolená / Podloga za kolena / Kelió kiltimélis / Cela paklājs / Põlvematt / Подложка за кољена / Подлога за koljena / Подлога за колена / Χαλάκι γονάτων / Rodillera / Tappetino per ginocchia / Joelheira / Genouillère / Knie mat

**VERTO**

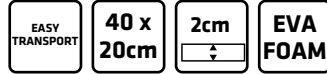

Ref.	📦	EAN
97H200	0/48	5902062096241

## Nakolanniki

Knee protectors / Наколеники / Наколінники / Térdvédők / Perne de genunchi / Chrániče kolien / Chrániče kolien / Zaščita za koleno / Kelių apsaugos / Ceļa aizsargi / Põlvekaitšmed / Наколеници / Šitnici za koljena / Šitnici za kolena / Επγονατίδες / Rodilleras de protecció / Copriginocchia / Proteção de joelhos / Protège-genoux / Kniebescherming

**VERTO**



Ref.	📦	EAN
97H201	0/50	5902062096258

## Ochroniacz słuchu, głowy i wzroku - 3 w 1

Head, eyes and hearing protector - 3 in 1 / Gehör-, Kopf- und Augenschutz - 3 in 1 / Средство защиты слуха, головы и зрения - 3 в 1 / Zaciš zaštitu slušnu, glavu i zrak - 3 в 1 / Hallás, fej és szemvédelem - 3 az 1-ben / Protecție auz, cap și vedere - 3 în 1 / Chránič sluchu, hlavy a oči - 3 v 1 / Chránič sluchu, hlavy a zraku - 3 v 1 / Varovalo sluha, glave in vida - 3 v 1 / Trys vienme - klausos organų, galvos ir regos apsauga / Galvas, dzirdes un redzes aizsargi - 3 vienā / Kõrvade, pea ja silmade kaitse - 3 in 1 / Зашцита на слуха, гласата и зрението - 3 в 1 / Šitnik sluha, glave i očiju - 3 u 1 / Zaščita za sluh, glavu i vid - 3 u 1 / Μέσο προστασίας ακοής, κεφαλής και όρασης: 3 σε 1 / Protector de oído, cabeza y vista - 3 en 1 / Dispositivo di protezione dell'udito, della testa e della vista - 3 in 1 / Beschermers van het gehoor, hoofd en zicht - 3 in 1

**VERTO**

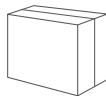

Ref.	📦	EAN
97H300	0/12	5902062042262

## Pas narzędziowy

Tool belt / Werkzeuggürtel / Сумка для инструмента на пояс / Пасок інструментальний / Szerszámtartó öv / Bandă adevzivă / Montérský pás / Opasok na náradie / Pas za orodje / Monterio diržas / Instrumentu josta / Liimimispressi lint / Колан за инструменти / Pojas za alat / Pojas torbica / Ζώνη μονταρίματος / Cinturón para herramientas reforzado / Cintura per montatore / Cinto p. montagem / Ceinture de monteur / Montageriem



**VERTO**

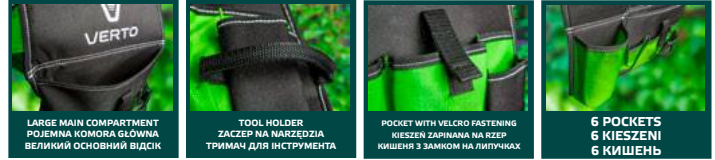

Ref.	info	📦	EAN
15G550	6 pockets	0/30	5902062039002





**ZABEZPIECZENIA**

PROTECTION ЗАХИСТ



## Klódka

Padlock / Vorhängeschloss / Замок навесной / Замок нависний / Lakat / Lacăt / Visací zámek / Visiaci zámok / Kľučavnica / Spyna / Piekaramā slēdzene / Tabalukk / Натинар / Lokot / Katanac / Λουκέτο / Candado / Lucchetto / Cadeado / Cadenas / Hangslot

### DeFort

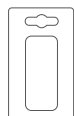
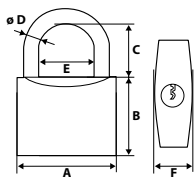

Ref.	A [mm]	B [mm]	C [mm]	D [mm]	E [mm]	F [mm]	📦	EAN
90U108	50	38	20	9	27	25	12/72	5902062208408
90U109	60	43	20	10	34	34	12/72	5902062208415

### DeFort

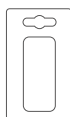
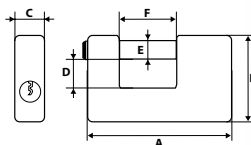

Ref.	A [mm]	B [mm]	C [mm]	D [mm]	E [mm]	F [mm]	📦	EAN
90U330	50	45	20	12	9	18,5	12/72	5902062903303
90U332	70	50	20	17	10	26	6/48	5902062903327
90U333	90	55	20	17,5	12	31	6/24	5902062903334

### TOP TOOLS

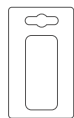

Ref.	W [mm]	📦	EAN
90U270	30	12/240	5902062902702
90U271	40	12/120	5902062902719
90U272	50	6/60	5902062902726
90U273	60	6/60	5902062902733

### TOP TOOLS

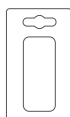

Ref.	W [mm]	📦	EAN
90U263	90	6/36	5902062902634

### TOP TOOLS

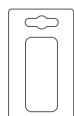

Ref.	W [mm]	📦	EAN
90U280	40	12/120	5902062902801
90U281	50	6/96	5902062902818

### TOP TOOLS

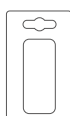

Ref.	W [mm]	📦	EAN
90U300	30	12/192	5902062903006
90U301	40	6/96	5902062903013
90U302	50	12/72	5902062903020
90U303	60	10/60	5902062903037
90U304	75	10/40	5902062903044

## Wkładka profilowa

Profile liner / Profileinlage / Профилированный вкладыш / Органиайзер / Profilbetét / Patron profilat / Profilová vložka / Profilová vložka / Profilni vložek / Profiliuota dėklė / profilēts ieliktnis / Profiltihend / Профилна вложка / uložak za bravu / Profilisani uložak / Διάτρητο ένθεμα / Bandeja clasificadora perfilada / Inserto perfilato / Cartucho perfilado / Insert profilé / Geprofileerde inlegger

### TOP TOOLS

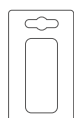

Ref.	L [mm]	📦	EAN
90U460	62 (31/31)	12/120	5902062904607

## Klódka szyfrowa

Code padlock / Chiffrevorhängeschloss / Замок кодовый / Замок нависний кодовый / Számszáras lakat / Lacăt / Visací zámek kódovaný / Visiaci zámok, kódovací / Kľučavnica z geslom / Kodinē spyna / Piekaramā slēdzene ar kodu / Koodiga tabalukk / Натинар / Lokot / Katanac / Λουκέτο με κωδικό / Candado con código para maletas / Lucchetto / Cadeado de código / Cadenas à codes / Code hangslot

### TOP TOOLS

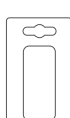

Ref.	W [mm]	📦	EAN
90U212	21	12/288	5902062230164
90U214	22	0/24	5902062230171





## Linka rowerowa

Bike lock / Fahrradseil / Замок велосипедный / Замок велосипедный / Kerékpárlakat / fixator bicicletă / Zámek jíz. Kola lankový / Zámok na bicykel / Kľučavnica za kolo / Spyna dviračiji / Veloslédzene / Rattalukk / Katanac za biciklo / Σπάγκος για κλειδωμα ποδηλάτου / Catena per bicicletta / Corda para bicicleta / Câble à vélo / Fietsslot



Ref.	L [cm]	Ø [mm]	📦	EAN
90U245	80	12	0/20	5902062220073

## Identifikatory do kluczy

Key labels / Schilder für Schlüssel / Бирки для ключей / Бірки до ключів / Kulcscímkék / Suport chei / Visačky na kľúče / Identifikatory na kľúče / Identifikatorji za kľuče / Raktų identifikatoriai / Atslėgu identifikatori / Võtmeidentifikaator / Идентификатори за ключове / Identifikatori za kľučevе / Identifikator za kľučevе / Καρτελάκια κλειδιών / Etiquetas para llaves / Identificatore per chiavi / Identificadores p. Chaves / Etiquettes pour clés / Sleutellabels



x12



Ref.	📦	EAN
90U250	50/200	5902062208569

## Plombownica

Sealing tongs / Plombenzange / Клещи plombировочные / Кліщі для plombування / Plombázó fogó / Masă de etanșare / Plombovací kleště / Plombovací klešte / Klešče za plombiranje / Plombavimo replės / Plombētājs / Isolatsioonitangid / Клещи за plombиране / Klijesta za plombiranje / Klesta za plombiranje / Ταμπίδες συγκόλλησης / Tenazas de sellado / Pinza per plombature / Máquina de lacrar / Pince à plomber / Vergrendeling



Ref.	L [mm]	📦	EAN
90U256	17	0/80	5902062200372





# GADŻETY

GADGETS ГАДЖЕТИ



## Długopis metalowy 5 w 1

Metal pen 5 in 1 / 5-in-1 Metall-Kugelschreiber / Металлическая шариковая ручка 5 в 1 / Металева ручка 5 в 1 / 5 az 1-ben fém golyóstoll / Pix cu bilă din metal 5 în 1 / Kovové kuličkové pero 5 v 1 / Kovové guľôčkové pero 5 v 1 / Kovinsko pisalo 5 v 1 / Metalinis rašiklis "5-in-1" / 5-in-1 metala lodīšu pildspalva / Метална химикалка 5 в 1 / Μεταλλικό στυλό 5 σε 1 / Bolígrafo metálico 5 en 1 / Penna a sfera in metallo 5 in 1 / Esferográfica de metal 5 em 1 / Stylo à bille en métal 5-en-1 / 5-in-1 metalen balpen

**NEO**  
TOOLS

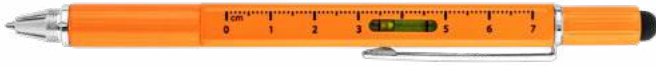

Ref.	📦	EAN
GD024	0/100	5907558484250

## Narzędzie wielofunkcyjne płatek śniegu 19 w 1

Snowflake multi-tool 19in1 / Multifunktionswerkzeug Schneeflocke 19 in 1 / Мультиинструмент Снежинка 19в1 / Мультиинструмент Сніжинка 19в1 / Multifunkciós szerszám hópehely 19az1-ben / Instrument multifuncțional fulg de zăpadă 19 în 1 / Multifunkční nástroj sněhová vločka 19 v 1 / Multifunkčný nástroj snehová vločka 19 v 1 / Večnamensko orodje snežinka 19 v 1 / Daugiafunkcinis įrankis snaižė 19 in 1 / Daudzfunkcionāls instruments sniegpārslīpa 19 in 1 / Многофункционален инструмент снежинка 19 в 1 / Πολυλειτουργικό εργαλείο χιονοπλάδα 19 σε 1 / Herramienta multifunción copo de nieve 19 en 1 / Strumento multifunzione fiocco di neve 19 in 1 / Floco de neve de ferramenta multifuncional 19 em 1 / Outil multifonctionnel flocon de neige 19 en 1 / Multifunctioneel gereedschap sneeuwvlok 19 in 1

**NEO**  
TOOLS



Ref.	📦	EAN
GD015	0/50	5907558465389

## Skarpety robocze

Working socks / Arbeitssocke / Рабочий носок / Шкарпетка робоча / Munkazokni / Şosetă de lucru / Pracovní ponožka / Pracovné ponožky / Delovna nogavica / Darbinės kojinės / Darba zeķes basic / Тöösokiid / Работен чоран / Radne čarape / Radna čarapa / Κάλσα εργαίας / Calzetin de trabajo / Calza da lavoro / Meias de trabalho / Chaussette de travail / Werksok

**NEO**  
TOOLS



80% COTTON  
MADE IN POLAND

Ref.	Size	📦	EAN
GD017	39-42	50/400	5907558481785
GD018	43-46	50/400	5907558481792

**GRAPHITE**



80% COTTON  
MADE IN POLAND

Ref.	Size	📦	EAN
GD019	39-42	50/400	5902062997777
GD020	43-46	50/400	5902062997784

## Brelok 6w1

Key ring 6in1 / Schlüsselanhänger 6-in-1 / Кольцо для ключей 6в1 / Брелок для ключей 6в1 / Kulcstartó szerszám 6az1-ben / Breloc 6 în 1 / Přívěsek na klíče 6v1 / Privesok na ključė 6 v 1 / Obesek za ključė 6 v 1 / Raktų pakabukas 6-in-1 / Atslėgu piekariņš 6-in-1 / Ключодержатель 6 в 1 / Μπρελόκ 6 σε 1 / Llavora 6en1 / Portachiavi 6-in-1 / Chaveiro 6-em-1 / Porte-clés 6-en-1 / Sleutelhanger 6-in-1

**NEO**  
TOOLS



Ref.	📦	EAN
GD09	250/1000	5907558459876

## Opaska magnetyczna

Magnetic wristband / Магнитный браслет / Магнітний ремінець / Mágneses zsinór / Bandă magnetică / Magnetický náramek / Magnetický náramok / Magnetni trak / Magnetinis apyrankė / Magnētiskā siksnā / Magnetiline esiriba / Магнитна лента за китка / Magnetska vrpca / Магнетна трака за ношење / Μαγνητική ζώνη / Braccialeto magnetico / Pulsera magnética / Pulseira magnética / Bracelet magnétique / Magnetische polsband

**NEO**  
TOOLS



Ref.	📦	EAN
GD012	10/50	5907558462425

## Rękawice robocze z magnesem

Working gloves with magnet / Arbeitshandschuhe / Перчатки рабочие с магнитом / Руквици робочі / Bőr kesztyű / Mänuși de lucru / Pracovní rukavice / Pracovné rukavice / Delovne rukavice / Darbo pirštīnės / Darba cimdi / Тöökindad / Ръкавици работни / Radne rukavice / Radne rukavice / Γάντια εργαίας / Guantes de trabajo / Guanti di lavoro / Luvas de trabalho / Gants de travail / Werkhandschoenen

**NEO**  
TOOLS



Ref.	📦	EAN
GD013	12/120	5907558462401
GD014	12/120	5907558462418

## Poduszka podróżna

Car pillow / Tragetasche / Автомобильная подушка / Автомобильная подушка / Autó párná / Pernă pentru mașină / Polštářek do auta / Podložka na prenášanie / Potovalni vzglavnik / Kelioninė pagalvė / Ceļojumu spilvens / Възглавница за пътуване / Μαξιλάρι ταξιδιού / Cojín para coche para / Neo tools car cushion / Travesseiro de viagem / Oreiller de voyage / Reiskussen

**NEO**  
TOOLS



Ref.	📦	EAN
GD016	0/18	5907558472097



## Poduszka opona 3D

3D pillow car tyre / 3D-Reifenkissen / 3D подушка для шин / 3D gumiabroncs párna / Perna 3D pentru anvelope / 3D polštář pro pneumatiky / 3D vankuš na pneumatiky / 3D blazina za pnevatike / 3D padangos ragalvė / 3D riepu spilvens / 3D възглавница за гуми / Μαξιλάρι ελαστικών 3D / Cojín de neumático 3D / Cuscino per pneumatici 3D / Almfoda de pneu 3D / Coussin de pneu 3D / 3D-bandkussen

**NEO**  
TOOLS



ø40  
cm

Ref.	📦	EAN
GD023	0/10	5907558484243

## Kubek

Mug / Чаша / Миска / Gipszelőedény / Cană / Koflík / Nádobna na sádru PVC / Čaša / Dubuo / Toveris / Tass / Канчок / Pvc posuda / Kadica / Μικρή κούπα / Beker / Bicchiere / Caneca / Bécher

**NEO**  
TOOLS



330ml

Ref.	📦	EAN
GD025	6/24	5907558485905
GD026	6/24	5902062093882
GD027	6/24	5907558485912
GD028	6/24	5907558485929

**NEO**  
TOOLS



400ml

Ref.	📦	EAN
GD08	0/48	5907558458821

## Termos

Vacuum flask / Isolierflasche / Термос / Термос / Termosz / Termos / Termoska / Termoska / Termovka / Termosas / Termoss / Termos / Термос / Termos boca / Termos / Θερμός / Termo / Borraccia termica / Garrafa térmica / Thermos / Thermosflës

**NEO**  
TOOLS



Ref.	V[ml]	📦	EAN
GD06	600	0/24	5907558454383
GD07	1000	0/24	5907558454390

## Zabawki

Toys / Spielsachen / Игрушки / Игрушки / Játékok / Hračky / Hračky / Igrače / Rotaļlietas / Žaislai / Mänguasjad / Игручки / Juguetes / Giocattoli / Brinquedos / Jouets / Speelgoed

**NEO**  
TOOLS



Ref.	📦	EAN
GD010	0/8	5907558459906
GD022	0/18	5907558483130

## GRAPHITE



CREATIVE



MANUAL SKILLS

AGE  
3+

2x  
AA

Ref.	📦	EAN
GD021	0/24	5902062998262

**NEO**  
TOOLS



Ref.	V[ml]	📦	EAN
GD06	600	0/24	5907558454383
GD07	1000	0/24	5907558454390

## GRAPHITE



Ref.	V[ml]	📦	EAN
GD04	800	0/30	5902062025012
GD05	500	0/50	5902062025029





# AKCESORIA ROWEROWE

BICYCLE ACCESSORIES

АКСЕСУАРИ ДЛЯ ВЕЛОСИПЕДІВ



## Lampka rowerowa przednia

Front bicycle lamp / Передній велосипедний фонарь / Передня велосипедна лампа / Első kerékpár lámpa / Lampa fata pentru bicicleta / Přední svítilna na kolo / Predná cyklistická lamp / Sprednja svetilka za kolo / Priekinis dviračio žibintas / Priekšējais velosipēda lukturis / Eesmine jalgratta lamp / Предна лампа за велосипед / Prednja lamp za bicikl / Предња лампа за бицикл / Μπροστίνο φωτιστικό ποδηλάτου / Lampada anteriore per bicicletta / Lámpara de bicicleta delantera / Lâmpada dianteira da bicicleta / Lampe de vélo avant / Fietslamp vooraan

NEO  
TOOLS



Ref. EAN  
91-004 0/120 5907558488418

NEO  
TOOLS



Ref. EAN  
91-005 0/120 5907558488425

## Światło rowerowe tylnie

Bike tail light / Fahrradrücklicht / Задній велосипедний фонарь / Задній велосипедний ліхтар / Hátsó kerékpár lámpa / Lumină spate pentru biciclete / Zadní světlo na kole / Zadné svetlo na bicykli / Zadnja kolesarska luč / Galinis dviračio žibintas / Aizmuģurējā velosipēda gaismā / Светлина за заден велосипед / Πίσω φως ποδηλάτου / Luz trasera de la bicicleta / Luce posteriore per bicicletta / Luz traseira de bicicleta / Feu arrière pour vélo / Achterlicht

NEO  
TOOLS



Ref. EAN  
91-002 0/240 5907558488395

NEO  
TOOLS



Ref. EAN  
91-003 10/100 5907558488401

## Uchwyt na telefon

Phone holder / Держатель телефона / Тримач телефону / Telefonartát / Suport pentru telefon / Držák telefonu / Držák na telefon / Držalo za telefon / Telefona laikiklis / Telefona turētājs / Telefoni hoidja / Стойка за телефон / Držac telefona / Држач за телефон / Θήκη τηλεφώνου / Porta telefono / Soporte para teléfono / Suporte de telefone / Support de téléphone / Telefoon houder

NEO  
TOOLS



Ref. EAN  
91-000 0/100 5907558488272

## Uchwyt na telefon z torbą

Phone holder with bag / Держатель телефона с сумкой / Тримач для телефону з сумкою / Telefonartát taskaval / Suport telefon cu geanta / Držák na telefon s taškou / Držák na telefon s taškou / Držalo za telefon s torbica / Telefona laikiklis su maišeliu / Telefona turetājs ar sominu / Telefoni hoidik koos kotiga / Поставка за телефон с чанта / Držac za telefon sa torbom / Држач за телефон са торбом / Porta telefono con borsa / Soporte para telefono con bolsa / Suporte de telefone com bolsa / Support de telephone avec sac / Telefoonhouder met tas

NEO  
TOOLS



Ref. EAN  
91-001 0/60 5907558488364

## Rękawiczki rowerowe

Cycling gloves / Radfahrer-Handschuhe / Велосипедные перчатки / Велосипедні рукавички / Kerékpáros kesztyű / Mänuși de ciclism / Κυκlistické rukavice / Κυκlistické rukavice / Kolesarske rokanice / Dviračio pirštinės / Riteņbraukšanas cimdi / Jalgrattakindad / Ръкавици за колоездене / Biciklističke rukavice / Бицикlistичке рукавице / Guantes de ciclismo / Guanti da ciclismo / Luvas de ciclismo / Gants de cyclisme

NEO  
TOOLS



Ref. Size ["] EAN  
91-016-M M 0/96 5907558488432  
91-016-L L 0/96 5907558488449  
91-016-XL XL 0/96 5907558488456

## Torba rowerowa

Bicycle bag / Сумка для велосипеда / Велосипедна сумка / Kerékpár táská / Geanta de bicicleta / Taška na kolo / Taška na bicykel / Torba za kolo / Dviračio krepšys / Velosipēdu soma / Jalgrattakott / Чанта за велосипед / Torba za bicikl / Torba za бицикл / Τοάντα ποδηλάτου / Borsa per bicicletta / Bolsa de bicicleta / Bolsa de bicicleta / Sacoche vélo / Fietstas

NEO  
TOOLS



Ref. EAN  
91-009 0/50 5907558488357



## Zestaw naprawczy rowerowy

Bicycle repair kit / Комплект для ремонта велосипеда / Набор для ремонту велосипеда / Kerékpárjavító készlet / Trusa de reparare biciclete / Sada na opravu jízdních kol / Súprava na opravu bicyklov / Komplet za popravilo koles / Dviračių remonto komplektas / Velosipēdu remonta komplekts / Jalgratta remondikomplekt / Ремонтен комплект за велосипеду / Set za popravak bicikla / Комплект за поправку бицикла / Kit επισκευής ποδηλάτου / Kit de reparación de bicicletas / Kit per la riparazione della bicicletta / Kit de reparação de bicicletas / Kit de réparation de vélos / Fietsreparatieset

**NEO**  
TOOLS



Ref. EAN  
91-013 0/24 5907558488319

## Łyżki do opon

Tire levers / Шинномонтажные рычаги / Вахселн шини / Gumiabroncs karok / Pârghii pentru anvelope / Páky na pneumatiky / Pnevmatiky / Ročice za pnevatike / Padangu svirtys / Riepu sviras / Rehvihoovad / Лостове за гуми / Полуге за гуме / Μοχλοί ελαστικών / Leve per pneumatici / Palancas para neumáticos / Alavancas de pneus / Démonte-pneus / Bandenlichters

**NEO**  
TOOLS



Ref. EAN  
91-008 0/200 5907558488289

## Lusterko rowerowe

Bicycle mirror / Велосипедное зеркало / Велосипедне дзеркало / Kerékpár tükör / Oglinda pentru bicicleta / Zrcátko na kolo / Zrkadlo na bicykel / Kolesarsko ogledalo / Dviračio veidrodis / Velosipēda spogulis / Jalgratta peegel / Огледало за велосипед / Ogljedalo za bicikl / Огледало за бицикл / Καθρέφτης ποδηλάτου / Espejo de bicicleta / Specchio per bicicletta / Espelho de bicicleta / Miroir de vélo / Fiets spiegel

**NEO**  
TOOLS



Ref. EAN  
91-011 0/120 5907558488333

## Mini pompka rowerowa

Mini bicycle pump / Мини велосипедный насос / Мини насос для велосипеда / Mini kerékpár pumpa / Mini pompa de bicicleta / Mini pumpa na kolo / Mini pumpa na bicykel / Mini črpalka za kolo / Mini dviračio siurblys / Mini velosipēda sūknis / Mini jalgratta pump / Мини помпа за велосипед / Mini pumpa za bicikl / Мини пумпа за бицикле / Mini αντλία ποδηλάτου / Mini bomba de bicicleta / Mini pompa da bicicletta / Mini bomba de bicicleta / Mini pompe à vélo / Mini fietspomp

**NEO**  
TOOLS

small size 0-11 bar /160 psi ball needle



Ref. EAN  
91-015 0/50 5907558488296

## Zapięcie rowerowe

Bicycle clasp / Велосипедная застежка / Велосипедна застібка / Kerékpár csat / Închizătoare pentru bicicletă / Sporna na kolo / Sporna na bicykel / Zаронка за kolo / Dviračio užsegimas / Velosipēda aizdare / Jalgratta kinnitus / Заночкална за велосипед / Корча за bicikl / Корча за бицикл / Κούμπωμα ποδηλάτου / Chiusura per bicicletta / Broche de bicicleta / Fecho de bicicleta / Fermaioir vélo / Fiets sluiting

**NEO**  
TOOLS



78 cm ZINC ALLOY +ABS  
615 g x3

Ref. EAN  
91-006 0/18 5907558488371

**NEO**  
TOOLS



cylinder: zinc alloy  
1200mm  
12mm

Ref. EAN  
91-007 0/40 5907558488388

## Uchwyt na bidon

Bottle holder / Держатель для бутылок / Тримач для пляшок / Palacktartó / Suport sticle / Držák na láhev / Držiak na fľašu / Držalo za steklenice / Butelio laikiklis / Pudeļu turētājs / Pudelihoiđija / Постава за бутылка / Držač za boce / Држач за флаше / Μπουκαλοθήκη / Portabottiglie / Sostenedor de botella / Suporte para garrafa / Porte-bouteille / Fless houder

**NEO**  
TOOLS



x2  
x1

Ref. EAN  
91-012 20/100 5907558488326



## Bidon

Water bottle / Бутылка с водою / Πляшка води / Vizesüveg / Sticla de apă / Láhev na vodu / Flaša na vodu / Sienlenica vode / Vandens butelis / Üdens pudel / Veerpedel / Бутылка за вода / Boda vode / Боча за воду / Φιάλη νερού / Bottiglia d'acqua / Botella de agua / Garrafa de agua / Bouteille d'eau / Waterfles

**NEO**  
TOOLS



**700**  
ml



Ref.  EAN  
91-010 0/100 5907558488340

## Stojak serwisowy

Service stand / Сервисный стенд / Сервісний стенд / Szerviz állvány / Stand de service / Servisní stojan / Servisný stojan / Servisno stojalo / Serviso stendas / Servisa stends / Hooldusalus / Сервисна стойка / Servisni stalak / Сервисни штанд / Σταντ σέρβις / Puesto de servicio / Stand di servizio / Bolsa de bicicleta / Support de service / Service stand

**NEO**  
TOOLS



**7kg**

**STEEL**

Load Capacity  
**30kg**

Ref.  EAN  
91-014 0/1 5907558488302





Ref	p.	Ref	p.	Ref	p.	Ref	p.	Ref	p.	Ref	p.	Ref	p.
01-010	117	01-193	112	01-543	134	02-404	141	02A415	261	04-014	90	04-212	100
01-011	117	01-194	112	01-550	129	02-405	141	02A420	261	04-015	90	04-213	93
01-012	117	01-195	112	01-551	129	02-406	141	02A511	261	04-016	90	04-214	94
01-013	117	01-200	137	01-555	133	02-407	140	02A530	261	04-019	92	04-220	111
01-014	117	01-202	137	01-557	135	02-407	141	02A540	261	04-020	92	04-221	111
01-015	118	01-203	137	01-558	135	02-407	141	02A550	261	04-021	90	04-222	111
01-016	118	01-204	137	01-559	135	02-408	141	02A560	261	04-022	90	04-225	97
01-017	118	01-216	125	01-556	135	02-409	141	02A580	261	04-023	90	04-228	99
01-018	118	01-217	125	01-600	349	02-410	142	02A625	259	04-024	90	04-240	92
01-019	120	01-220	127	01-601	349	02-411	140	02A635	259	04-025	90	04-250	109
01-020	119	01-221	127	01-602	349	02-412	137	02A645	259	04-026	90	04A130	277
01-021	122	01-222	127	01-603	349	02-413	137	02A655	259	04-028	92	04A140	277
01-022	122	01-223	127	01-604	349	02-415	139	02A665	259	04-031	91	04A160	277
01-026	381	01-224	127	01-605	349	02-416	139	02A675	259	04-032	91	04A175	277
01-027	381	01-225	127	01-606	349	02-417	139	02A706	258	04-033	91	04A190	277
01-028	381	01-226	128	01-607	349	02-418	139	02A708	258	04-034	91	04A210	277
01-085	123	01-227	127	01-608	349	02-419	139	02A715	261	04-035	91	04A212	277
01-086	123	01-228	127	01-609	349	02-420	138	02A832	261	04-036	91	04A230	278
01-087	123	01-229	128	01-610	349	02-421	138	02A833	261	04-037	108	04A234	278
01-088	123	01-231	128	01-611	349	02-422	138	02A835	261	04-044	91	04A236	278
01-089	123	01-232	127	01-612	349	02-423	139	02A838	261	04-045	91	04A239	278
01-090	123	01-233	129	01-613	349	02-424	139	02A840	261	04-046	91	04A240	277
01-091	123	01-234	130	01-614	349	02-425	139	02A850	258	04-051	110	04A250	277
01-092	123	01-235	129	01A117	271	02-426	138	02A855	257	04-052	110	04A260	277
01-093	123	01-236	129	01A118	271	02-427	138	02A901	262	04-053	110	04A280	277
01-094	123	01-237	130	01A124	271	02-428	138	02A902	262	04-054	110	04A312	278
01-095	123	01-240	127	01A130	271	02-429	140	02A903	262	04-055	110	04A315	278
01-096	123	01-241	127	01A135	271	02-430	141	02A904	262	04-062	110	05 114	191
01-097	123	01-242	127	01A218	271	02-431	143	02A905	262	04-063	110	05 115	191
01-101	120	01-243	128	01A224	271	02-432	143	02A906	262	04-071	110	05A136	420
01-102	121	01-244	128	01A425	272	02-433	143	02A907	262	04-072	110	05A138	420
01-103	121	01-245	128	01A426	272	02-434	143	02A910	260	04-073	110	05A140	420
01-105	120	01-250	117	01A427	272	02-435	137	02A911	258	04-112	97	05A142	420
01-106	122	01-251	117	01A440	272	02-436	137	02A912	257	04-113	97	05A146	420
01-110	113	01-252	117	01A445	273	02-438	143	02A913	259	04-114	97	05A148	420
01-111	113	01-253	117	01A552	273	02-439	143	02A930	264	04-115	97	05A206	421
01-112	113	01-254	118	01A554	273	02-441	137	03-010	145	04-116	97	05A208	421
01-113	113	01-255	118	01A997	273	02-442	141	03-011	145	04-117	97	05A210	421
01-114	113	01-256	118	01A998	273	02-443	139	03-012	145	04-130	110	05A212	421
01-115	113	01-257	118	01A999	273	02-444	140	03-013	145	04-131	110	05A220	420
01-116	113	01-260	273	02-001	79	02-445	142	03-014	145	04-132	110	05A221	420
01-117	113	01-306	113	02-005	140	02 562	161	03-015	145	04-133	110	05A222	420
01-118	113	01-307	113	02-010	140	02A010	260	03-016	145	04-136	110	05A223	420
01-119	113	01-308	112	02-020	140	02A012	260	03-017	145	04-137	110	05A306	421
01-120	113	01-309	112	02-030	364	02A050	263	03-019	145	04-138	110	05A308	421
01-122	113	01-310	114	02-031	364	02A057	263	03-020	145	04-139	110	05A310	421
01-123	113	01-311	114	02-032	364	02A082	264	03-021	145	04-140	110	05A312	421
01-124	113	01-400	130	02-040	140	02A083	264	03-022	145	04-142	111	05A436	421
01-125	113	01-401	134	02-041	140	02A084	264	03-023	145	04-143	111	05A450	421
01-126	113	01-402	79	02-042	140	02A085	264	03-024	145	04-171	90	05A460	421
01-127	113	01-500	131	02-044	140	02A087	264	03-025	145	04-172	90	05A470	421
01-128	113	01-501	132	02-050	142	02A088	264	03-026	145	04-173	90	05G100	420
01-129	113	01-502	132	02-060	139	02A089	264	03-027	145	04-174	90	05G101	420
01-150	124	01-503	133	02-066	142	02A110	421	03-028	145	04-175	90	05G102	420
01-151	124	01-506	132	02-069	139	02A140	257	03-029	145	04-176	90	05G103	420
01-152	117	01-507	132	02-072	142	02A160	257	03-030	87	04-177	90	05G104	420
01-153	117	01-509	122	02-073	140	02A180	257	03-031	87	04-178	90	05G120	421
01-154	117	01-510	134	02-074	140	02A201	262	03A136	276	04-179	90	05G201	420
01-155	117	01-511	134	02-075	140	02A202	262	03A139	276	04-180	90	05G202	420
01-156	119	01-512	135	02-076	140	02A203	262	03A149	276	04-181	90	05G203	420
01-157	119	01-513	134	02-077	140	02A204	262	03A159	276	04-182	91	06-011	108
01-158	119	01-514	134	02-078	140	02A205	262	03A169	276	04-183	91	06-020	108
01-160	274	01-515	134	02-106	139	02A208	262	03A170	276	04-184	91	06-036	108
01-162	274	01-516	134	02-107	139	02A210	262	03A171	276	04-185	91	06-037	108
01-165	124	01-517	134	02-109	143	02A215	262	03A180	276	04-186	91	06-040	108
01-171	112	01-518	134	02-111	139	02A220	262	03A225	276	04-187	91	06-070	106
01-172	112	01-519	131	02-112	139	02A305	262	03A230	276	04-188	91	06-071	106
01-173	112	01-520	131	02-120	138	02A310	263	03A235	276	04-189	91	06-072	106
01-175	112	01-524	130	02-121	138	02A315	263	03A245	276	04-190	91	06-073	106
01-176	112	01-525	128	02-122	138	02A320	263	03A320	276	04-191	94	06-078	106
01-177	112	01-526	365	02-123	138	02A325	263	03A325	276	04-192	94	06-101	102
01-180	112	01-528	365	02-124	138	02A330	260	03A440	277	04-193	94	06-103	102
01-181	112	01-530	133	02-126	138	02A343	262	03A441	276	04-194	94	06-104	102
01-182	112	01-531	133	02-127	138	02A344	262	03A442	276	04-196	97	06-105	102
01-183	112	01-532	132	02-128	138	02A345	262	03A445	276	04-197	96	06-106	102
01-184	112	01-533	132	02-130	139	02A347	262	03A490	297	04-200	109	06-107	73
01-185	112	01-534	131	02-131	139	02A354	262	04-001	90	04-201	96	06-108	100
01-186	112	01-535	113	02-132	139	02A355	262	04-002	90	04-204	93	06-111	99
01-187	112	01-536	132	02 366	161	02A401	261	04-004	90	04-206	93	06-115	99
01-188	112	01-537	132	02 372	161	02A402	261	04-006	90	04-207	93	06-116	99
01-189	112	01-538	131	02-400	144	02A403	261	04-007	90	04-208	94	06-122	101
01-190	112	01-539	132	02-401	137	02A405	261	04-011	90	04-209	96	06-123	101
01-191	112	01-540	131	02-402	141	02A408	261	04-012	90	04-210	96	06-127	101
01-192	112	01-542	131	02-403	141	02A410	261	04-013	90	04-211	96	06-129	101

Ref	p.	Ref	p.	Ref	p.	Ref	p.	Ref	p.	Ref	p.	Ref	p.
06-130	101	08-058	64	08-256	68	08-467	63	08-597	66	08A115	286	09-411	81
06A000	279	08-061	37	08-257	69	08-468	63	08-598	66	08A422	293	09-412	81
06A010	279	08-070	65	08-300	64	08-469	63	08-599	66	08A424	293	09-413	81
06A015	279	08-071	65	08-301	64	08-470	63	08-603	53	08A426	293	09-414	81
06A020	279	08-072	65	08-302	64	08-471	63	08-649	73	08A428	293	09-415	81
06A025	279	08-073	65	08-304	64	08-472	63	08-650	66	08A430	293	09-416	81
06A130	278	08-074	65	08-306	64	08-473	63	08-651	66	08A434	293	09-417	81
06A230	278	08-075	65	08-307	64	08-474	63	08-690	36	08A606	293	09-418	81
06A250	278	08-076	65	08-308	64	08-475	63	08-692	35	08A608	293	09-419	81
06A330	279	08-077	65	08-309	64	08-476	63	08-694	35	08A610	293	09-421	81
06A430	278	08-078	65	08-311	64	08-477	63	08-705	71	08A612	293	09-422	81
06A530	279	08-080	65	08-312	64	08-478	63	08-706	71	08A615	293	09-424	81
06A615	264	08-081	65	08-313	64	08-479	63	08-707	72	09-042	83	09-427	81
06A635	264	08-082	65	08-314	64	08-480	63	08-708	72	09-043	83	09-429	81
06A721	278	08-083	65	08-315	64	08-482	63	08-710	74	09-044	83	09-430	81
06A722	278	08-084	65	08-316	64	08-486	63	08-711	72	09-045	83	09-432	81
06A723	278	08-085	65	08-319	64	08-487	63	08-712	201	09-051	84	09-512	75
06A724	278	08-086	65	08-320	65	08-488	63	08-713	72	09-052	84	09-514	77
06A725	278	08-090	166	08-321	65	08-489	63	08-730	70	09-053	84	09-515	75
06A786	280	08-091	166	08-322	65	08-490	63	08-731	70	09-054	84	09-516	78
06A788	280	08-151	69	08-323	65	08-491	63	08-732	70	09-055	84	09-517	75
06A831	279	08-152	69	08-324	65	08-492	63	08-733	70	09-056	84	09-518	77
06A832	279	08-153	69	08-325	65	08-493	63	08-734	70	09-057	84	09-523	75
06A833	279	08-154	69	08-326	65	08-494	63	08-735	70	09-058	84	09-524	77
07 605	191	08-155	68	08-327	65	08-495	63	08-736	70	09-059	84	09-525	75
07 622	191	08-168	63	08-328	65	08-497	63	08-740	70	09-060	84	09-526	78
07 623	191	08-170	63	08-329	65	08-498	63	08-741	70	09-061	84	09-530	75
07A107	274	08-171	63	08-331	65	08-499	63	08-742	70	09-062	84	09-531	75
07A110	274	08-172	63	08-332	65	08-501	67	08-743	70	09-063	83	09-532	75
07A112	274	08-173	63	08-333	65	08-502	67	08-744	70	09-064	83	09-533	75
07A115	274	08-174	63	08-335	65	08-503	66	08-745	70	09-065	83	09-534	75
07A206	275	08-175	63	08-340	64	08-504	67	08-746	70	09-066	83	09-535	75
07A210	274	08-176	63	08-341	64	08-507	66	08-750	71	09-067	83	09-536	75
07A212	274	08-177	63	08-350	69	08-508	67	08-751	71	09-068	83	09-537	75
07A215	274	08-178	63	08-351	69	08-511	67	08-752	71	09-069	83	09-538	75
07A220	274	08-179	63	08-352	69	08-512	67	08-753	71	09-141	85	09-539	75
07A306	275	08-180	63	08-353	68	08-513	67	08-754	71	09-143	85	09-540	75
07A307	275	08-181	63	08-355	67	08-514	67	08-755	71	09-145	85	09-541	75
07A310	275	08-182	63	08-356	68	08-515	67	08-756	71	09-147	85	09-542	75
07A415	300	08-184	63	08-357	68	08-516	67	08-757	71	09-149	85	09-543	75
07A420	300	08-185	63	08-408	63	08-519	67	08-758	71	09-151	85	09-544	75
08-008	64	08-186	63	08-409	63	08-520	66	08-759	71	09-176	86	09-545	75
08-009	64	08-187	63	08-410	63	08-521	67	08-760	71	09-203	88	09-546	75
08-010	64	08-188	63	08-411	63	08-523	67	08-761	71	09-205	88	09-550	77
08-011	64	08-189	63	08-412	63	08-524	67	08-762	71	09-208	88	09-551	77
08-012	64	08-190	63	08-413	63	08-525	67	08-763	71	09-212	88	09-552	77
08-013	64	08-191	63	08-414	63	08-530	66	08-764	71	09-214	88	09-553	77
08-014	64	08-192	63	08-415	63	08-533	66	08-765	71	09-302	88	09-554	77
08-015	64	08-193	63	08-416	63	08-536	66	08-766	71	09-320	83	09-555	77
08-016	64	08-194	63	08-417	63	08-540	66	08-767	71	09-321	83	09-556	77
08-017	64	08-195	63	08-418	63	08-543	66	08-770	70	09-322	83	09-557	77
08-018	64	08-196	63	08-419	63	08-546	66	08-771	70	09-323	83	09-558	77
08-019	64	08-197	63	08-421	63	08-550	69	08-772	70	09-324	83	09-559	77
08-020	64	08-220	62	08-422	63	08-551	69	08-773	70	09-325	83	09-570	53
08-021	64	08-221	62	08-423	63	08-552	69	08-774	70	09-326	83	09-571	75
08-022	64	08-222	62	08-424	63	08-553	68	08-775	70	09-327	83	09-573	78
08-023	64	08-223	62	08-425	63	08-554	69	08-776	70	09-328	83	09-605	89
08-024	64	08-224	62	08-426	63	08-555	68	08-777	70	09-329	83	09-607	89
08-025	64	08-225	62	08-427	63	08-556	68	08-778	70	09-330	83	09-608	89
08-026	64	08-226	62	08-429	63	08-557	69	08-780	70	09-331	83	09-609	89
08-027	64	08-227	62	08-430	63	08-558	69	08-781	70	09-333	83	09-615	89
08-028	64	08-228	62	08-431	63	08-559	68	08-782	70	09-334	83	09-650	81
08-029	64	08-229	62	08-432	63	08-560	68	08-783	70	09-336	83	09-651	81
08-030	64	08-230	62	08-442	63	08-562	69	08-784	70	09-338	83	09-652	81
08-032	64	08-231	62	08-443	63	08-563	69	08-821	80	09-339	83	09-653	81
08-036	64	08-232	62	08-444	63	08-564	69	08-822	80	09-340	83	09-654	81
08-039	64	08-235	62	08-446	63	08-565	69	08-823	80	09-341	83	09-655	81
08-040	64	08-236	62	08-447	63	08-580	66	08-824	80	09-342	83	09-656	81
08-041	64	08-237	62	08-448	63	08-581	66	08-825	80	09-345	84	09-657	81
08-042	64	08-238	62	08-449	63	08-582	66	08-826	80	09-360	87	09-658	81
08-043	64	08-239	62	08-450	63	08-583	66	08-827	80	09-361	87	09-659	81
08-044	64	08-240	62	08-451	63	08-584	66	08-828	80	09-362	87	09-660	81
08-045	64	08-241	62	08-452	63	08-585	66	08-830	81	09-363	87	09-661	81
08-046	64	08-242	62	08-453	63	08-586	66	08-835	80	09-364	87	09-662	81
08-047	64	08-243	62	08-454	63	08-587	66	08-837	80	09-365	87	09-663	81
08-048	64	08-244	62	08-458	63	08-588	66	08-838	80	09-366	87	09-665	81
08-049	64	08-245	62	08-459	63	08-589	66	08-839	80	09-367	87	09-666	81
08-050	64	08-246	62	08-460	63	08-590	66	08-843	80	09-368	87	09-668	81
08-051	64	08-247	62	08-461	63	08-591	66	08-845	80	09-370	87	09-671	81
08-052	64	08-251	69	08-462	63	08-592	66	08-910	50	09-406	81	09-672	81
08-053	64	08-252	69	08-463	63	08-593	66	08-915	51	09-407	81	09-674	81
08-054	64	08-253	69	08-464	63	08-594	66	08-920	59	09-408	81	09-675	81
08-055	64	08-254	69	08-465	63	08-595	66	08A108	293	09-409	81	09-706	81
08-056	64	08-255	69	08-466	63	08-596	66	08A110	293	09-410	81	09-707	81

Ref	p.	Ref	p.	Ref	p.	Ref	p.	Ref	p.	Ref	p.	Ref	p.
09-708	81	09A116	280	10-329	70	10-908	74	10A848	271	11-315	149	11-763	182
09-709	81	09A118	280	10-330	70	10-910	74	10A903	419	11-316	149	11-796	167
09-710	81	09A120	280	10-331	70	10-920	74	10A905	419	11-317	149	11-797	167
09-711	81	09A122	280	10-332	70	10-922	74	10A906	419	11-320	149	11-798	167
09-712	81	09A125	280	10-333	70	10-924	74	10A907	419	11-321	150	11-799	168
09-713	81	09A132	280	10-334	70	10-926	74	10A915	419	11-322	150	11-801	168
09-714	81	09A138	280	10-335	70	10-928	74	10A916	419	11-323	150	11-802	168
09-715	81	09A310	280	10-336	70	10-940	74	10A917	419	11-324	150	11-803	168
09-716	81	09A320	281	10-337	70	10-942	74	11-020	126	11-325	150	11-804	168
09-717	81	09A322	281	10-338	70	10-944	74	11-021	126	11-326	150	11-805	167
09-718	81	09A410	280	10-339	70	10-946	74	11-022	126	11-330	151	11-806	167
09-719	81	09A412	280	10-340	71	10-948	74	11-024	126	11-331	151	11-807	167
09-720	81	09A414	280	10-341	71	10-960	74	11-030	174	11-332	151	11-808	167
09-721	81	09A416	280	10-342	71	10-970	74	11-100	165	11-333	151	11-810	170
09-722	81	09A420	280	10-343	71	10-972	74	11-101	165	11-334	152	11-811	170
09-723	81	09A425	280	10-344	71	10-978	74	11-102	165	11-335	151	11-812	170
09-724	81	09A432	280	10-345	71	10-980	74	11-111	165	11-336	151	11-813	170
09-725	81	100.0	298	10-346	71	10-982	74	11-112	165	11-337	152	11-816	167
09-727	81	10-000	35	10-401	190	10-988	74	11-113	165	11-338	148	11-817	170
09-728	81	10-004	36	10-402	190	10A035	266	11-122	163	11-360	159	11-819	178
09-729	81	10-006	36	10-403	190	10A055	266	11-123	163	11-361	159	11-822	174
09-730	81	10-008	37	10-404	190	10A065	270	11-125	163	11-362	159	11-823	174
09-732	81	10-020	35	10-405	190	10A115	267	11-126	163	11-363	159	11-824	174
09-734	81	10-030	35	10-406	190	10A130	267	11-127	163	11-364	159	11-825	174
09-736	81	10-032	38	10-407	190	10A135	267	11-128	163	11-365	159	11-827	169
09-738	81	10-036	37	10-408	190	10A145	267	11-129	163	11-366	159	11-832	180
09-741	81	10-038	38	10-410	191	10A150	267	11-130	164	11-367	159	11-834	179
09-746	81	10-042	39	10-411	191	10A160	267	11-131	164	11-368	159	11-836	179
09-747	81	10-054	40	10-450	181	10A214	270	11-132	164	11-369	159	11-847	168
09-749	81	10-058	39	10-451	181	10A216	270	11-135	164	11-370	159	11-848	170
09-750	82	10-059	40	10-452	181	10A225	267	11-152	166	11-371	159	11-850	169
09-751	82	10-060	41	10-453	181	10A230	267	11-153	166	11-372	159	11-851	169
09-752	82	10-062	41	10-454	181	10A235	267	11-165	166	11-373	159	11-852	169
09-753	82	10-066	44	10-455	181	10A310	270	11-167	156	11-380	160	11-857	169
09-754	82	10-070	44	10-456	181	10A330	270	11-168	156	11-381	160	11-858	169
09-760	82	10-072	45	10-470	185	10A332-72	270	11-169	156	11-382	160	11-859	169
09-761	82	10-074	46	10-471	185	10A333	270	11-170	154	11-383	159	11-861	169
09-762	82	10-076	48	10-472	185	10A335	270	11-171	154	11-384	159	11-862	169
09-763	82	10-078	49	10-473	185	10A336	270	11-190	166	11-400	174	11-865	169
09-764	82	10-196	58	10-474	185	10A337	270	11-191	166	11-401	174	11-866	169
09-765	82	10-200	57	10-477	184	10A337-72	270	11-192	166	11-402	174	11-867	169
09-766	82	10-202	57	10-480	185	10A339	270	11-203	153	11-403	174	11-868	169
09-767	82	10-206	42	10-481	185	10A440	265	11-204	153	11-404	174	11-869	169
09-768	82	10-208	43	10-482	185	10A441	264	11-205	153	11-500	162	11-870	169
09-769	82	10-210	43	10-500	186	10A442	265	11-218	154	11-510	161	11-871	169
09-770	82	10-212	42	10-501	186	10A445	265	11-221	155	11-511	161	11-872	169
09-771	82	10-216	47	10-502	186	10A446	264	11-222	155	11-512	191	11-873	169
09-791	82	10-218	52	10-503	186	10A447	265	11-223	155	11-532	162	11-880	152
09-806	84	10-250	201	10-504	186	10A450	265	11-224	155	11-550	161	11-881	152
09-808	84	10-251	201	10-505	187	10A451	264	11-226	155	11-555	161	11-882	152
09-810	84	10-252	201	10-506	187	10A452	265	11-227	155	11-560	161	11-883	153
09-812	84	10-253	201	10-507	187	10A453	265	11-228	155	11-561	161	11-884	153
09-814	84	10-254	201	10-508	188	10A504	265	11-231	160	11-600	183	11-885	154
09-816	84	10-255	201	10-509	187	10A505	265	11-235	159	11-601	183	11-890	180
09-817	84	10-256	201	10-510	187	10A506	265	11-237	160	11-610	178	11-891	180
09-818	84	10-257	201	10-511	187	10A540	265	11-238	160	11-611	178	11-892	180
09-819	84	10-258	200	10-569	188	10A545	265	11-239	160	11-612	178	11-893	180
09-820	84	10-259	200	10-570	188	10A550	265	11-240	160	11-614	178	11-901	172
09-821	84	10-260	200	10-571	188	10A640	265	11-241	160	11-620	260	11-902	172
09-824	84	10-261	200	10-572	188	10A645	265	11-242	158	11-621	260	11-903	172
09-825	84	10-262	200	10-573	188	10A703	268	11-243	158	11-625	260	11-904	172
09-851	85	10-263	200	10-574	188	10A706	268	11-250	156	11-634	263	11-905	172
09-852	85	10-264	200	10-575	188	10A710	268	11-261	157	11-636	263	11-906	172
09-860	84	10-265	200	10-576	188	10A713	268	11-262	157	11-640	260	11-907	172
09-890	330	10-300	66	10-577	188	10A715	268	11-263	157	11-690	171	11-908	172
09-906	86	10-310	70	10-578	188	10A717	268	11-264	157	11-691	171	11-909	172
09-908	86	10-311	70	10-579	188	10A717P	268	11-265	158	11-710	183	11-915	172
09-910	86	10-312	70	10-580	188	10A719	268	11-266	158	11-711	184	11-920	171
09-912	86	10-313	70	10-581	188	10A722	269	11-267	156	11-712	184	11-922	171
09-914	86	10-314	70	10-582	188	10A723	269	11-270	178	11-714	183	11-925	171
09-916	86	10-315	70	10-583	188	10A725	268	11-299	152	11-716	183	11-931	172
09-918	86	10-316	70	10-584	188	10A733	269	11-300	147	11-718	184	11-950	175
09-920	86	10-317	70	10-585	188	10A750	418	11-301	147	11-719	184	11-952	175
09-921	86	10-318	70	10-586	188	10A760	269	11-302	147	11-720	181	11-953	175
09-924	86	10-319	70	10-587	188	10A761	269	11-303	147	11-730	181	11-956	175
09-930	86	10-320	70	10-588	189	10A803	271	11-304	147	11-731	181	11-960	175
09-952	86	10-321	70	10-590	189	10A822	271	11-305	148	11-732	181	11-961	175
09-980	87	10-322	71	10-596	189	10A824	271	11-306	147	11-735	182	11-963	175
09A106	280	10-323	71	10-602	189	10A827	271	11-307	148	11-749	183	11-969	177
09A108	280	10-324	71	10-606	190	10A840	271	11-310	148	11-750	182	11-970	175
09A110	280	10-325	71	10-900	74	10A842	271	11-311	149	11-751	182	11-971	176
09A112	280	10-326	71	10-902	74	10A843	271	11-312	148	11-760	182	11-972	176
09A114	280	10-327	71	10-904	74	10A844	271	11-313	148	11-761	182	11-973	177
09A115	280	10-328	71	10-906	74	10A846	271	11-314	149	11-762	182	11-974	176

Ref	p.	Ref	p.	Ref	p.	Ref	p.	Ref	p.	Ref	p.	Ref	p.
11-975	176	12-632	203	13-961	295	14-710	205	15-708	400	15G102	418	15G730	405
11-976	177	12-635	203	13-962	295	14-712	205	15-710	402	15G155	419	15G730-30	405
11-977	177	12-636	203	13-963	295	14-714	208	15-711	402	15G156	419	15G731	406
11-978	177	12-636-101	162	13-968	295	14-716	208	15-715	407	15G190	419	15G731-30	406
11-979	176	12-637	203	13A100	285	14-718	208	15-720	405	15G191	419	15G732	405
11-980	176	12-640	203	13A102	285	14-720	207	15-721	405	15G200	413	15G732-30	405
11-981	174	12-641	203	13A119	285	14-722	207	15-722	405	15G201	413	15G733	406
11-983	177	12-643	162	13A228	286	14-724	207	15-723	405	15G202	413	15G733-30	406
11-984	179	12-645	203	13A248	286	14-730	202	15-730	405	15G203	413	15G740	407
11-985	179	12-646	203	13A249	286	14-732	202	15-731	405	15G204	414	15G740-30	407
11-986	179	12-650	203	13A250	286	14-734	201	15-732	405	15G205	413	15G742	406
11-991	178	12-651	203	13A284	287	14-800	202	15-733	405	15G206	413	15G742-30	406
11-992	178	12-655	203	13A286	287	14-802	202	15-736	406	15G207	414	15G743	406
11-993	178	12-655-810	162	13A288	287	14-804	202	15-737	406	15G250	415	15G743-30	406
11-997	179	12-656	203	13A290	287	14-806	202	15-740	407	15G251	415	15G744	406
11A145	298	12-656-810	162	13A320	289	14-808	202	15-741	407	15G252	416	15G744-30	406
11A230	298	12-665-810	162	13A321	289	14-820	207	15-742	406	15G253	415	15G745	406
11A314	298	12-666-810	162	13A332	288	14A105	89	15-743	406	15G254	416	15G745-30	406
12-070	202	12-679	162	13A334	288	14A110	89	15-744	406	15G255	415	15G746	406
12-071	202	12-902	161	13A336	288	14A203	173	15-745	406	15G256	415	15G747	406
12-072	202	12-908	161	13A338	288	14A204	173	15-746	407	15G257	415	15G750	407
12-074	202	12-908	173	13A340	286	14A205	173	15-747	407	15G258	415	15G751	407
12-075	202	12-909	173	13A342	288	14A206	173	15-748	406	15G259	415	15G760	407
12-076	202	12-910	173	13A360	292	14A208	173	15-749	406	15G260	416	15G761	407
12-079	202	12-915	172	13A520	291	14A210	173	15-750	407	15G261	416	15G770	403
12-080	202	12A100	281	13A525	291	14A212	173	15-771	403	15G300	416	15G771	403
12-081	202	12A102	281	13A530	291	14A305	174	15-772	403	15G301	416	15G772	404
12-101	200	12A120	281	13A545	291	14A306	174	15-780	404	15G302	416	15G773	404
12-102	200	12A123	281	13A560	291	14A308	174	15-790	408	15G310	417	15G780	404
12-105	200	12A125	281	13A587	285	14A310	174	15-791	408	15G311	417	15G781	404
12-107	200	12A128	281	13A588	285	14A312	174	15-792	409	15G312	417	15G785	404
12-110	200	12A130	281	13A620	362	14A410	173	15-793	409	15G313	417	15G788	404
12-115	200	12A135	281	13A630	362	14A420	173	15-800	410	15G350	417	15G790	408
12-210	200	12A200	281	13A700	293	14A425	172	15-801	410	15G405	423	15G791	409
12-212	200	12A201	281	13A703	294	14A426	173	15-802	410	15G406	423	15G798	409
12-213	200	12A202	281	13A712	294	14A430	173	15-803	410	15G407	423	15G800	410
12-214	200	12A203	281	13A716	294	14A523	297	15-804	410	15G408	423	15G801	410
12-215	200	12A215	281	13A720	294	14A604	297	15-805	410	15G409	424	15G802	410
12-216	200	12A216	281	13A760	294	14A605	297	15-820	410	15G410	424	15G803	410
12-217	200	12A220	281	13A780	294	14A606	297	15-821	410	15G450	425	15G804	410
12-219	200	12A223	281	13A800	285	14A614	297	15-822	410	15G455	426	15G805	410
12-221	200	12A225	281	13A805	285	14A615	297	15-823	410	15G456	426	15G820	410
12-222	200	12A228	281	13A810	285	14A616	297	15-824	410	15G501	408	15G821	410
12-224	200	12A300	282	13A830	285	14A618	297	15-825	410	15G502	408	15G822	410
12-310	200	12A305	282	13A835	285	14A623	297	15-840	410	15G503	408	15G823	410
12-312	200	12A340	282	13A890	290	14A710	298	15-841	410	15G504	408	15G824	410
12-313	200	12A350	282	14-002	195	14A803	295	15-842	410	15G505	408	15G825	410
12-314	200	12A375	283	14-004	195	14A810	295	15-843	410	15G506	408	15G851	409
12-315	200	12A380	282	14-006	195	14A812	295	15-844	410	15G507	408	15G852	409
12-316	200	12A382	282	14-008	195	14A872	295	15-845	410	15G508	408	15G890	410
12-317	200	12A384	282	14-010	196	14A892	295	15-880	411	15G510	425	15G891	411
12-319	200	12A410	283	14-012	196	14A895	296	15-891	411	15G511	425	15G900	427
12-321	200	12A415	283	14-013	197	15 007	162	15-900	426	15G512	425	15G901	427
12-322	200	12A422	283	14-014	196	15 009	162	15-901	426	15G513	425	15G902	427
12-324	200	12A515	281	14-016	196	15 013	162	15-902	426	15G514	425	15G903	427
12-350	202	12A520	281	14-017	198	15 113-140	162	15-910	426	15G515	425	15G904	427
12-562	207	12A530	281	14-018	196	15-200	412	15-911	426	15G530	425	15G905	427
12-564	207	12A545	281	14-019	196	15-201	412	15-950	411	15G535	425	15G906	427
12-600	203	12A560	281	14-020	197	15-202	412	15-951	411	15G540	421	15G907	427
12-601	203	12A575	281	14-026	197	15-203	412	15-952	411	15G541	426	15G908	427
12-602	203	12A590	281	14-028	198	15-204	412	15-960	426	15G550	428	15G930	427
12-605	203	12K010	204	14-029	198	15-207	412	15-962	426	15G700	402	15G931	427
12-606	203	12K020	204	14-030	198	15-208	412	15G001	422	15G701	402	15G932	427
12-610	203	12K021	204	14-031	198	15-210	413	15G002	422	15G702	401	15G933	427
12-611	203	12K022	204	14-032	198	15-211	412	15G003	422	15G703	401	15G934	427
12-612	203	12K030	204	14-034	198	15-212	413	15G004	422	15G704	401	15G935	427
12-613	203	12K031	204	14-036	205	15-213	412	15G010	422	15G705	402	15G936	427
12-615	203	13 012	192	14-220	206	15-215	414	15G011	422	15G706	401	15G937	427
12-616	203	13 020	192	14-500	195	15-250	414	15G012	423	15G707	400	16-030	336
12-617	203	13 055	192	14-502	195	15-251	414	15G013	425	15G708	401	16-031	336
12-618	203	13-800	295	14-508	197	15-252	414	15G014	422	15G709	401	16-032	336
12-620	203	13-801	295	14-510	197	15-253	414	15G017	422	15G710	400	16-033	336
12-621	203	13-802	295	14-514	197	15-254	414	15G030	424	15G711	402	16-034	337
12-622	203	13-805	295	14-550	202	15-620	406	15G031	424	15G712	403	16-040	337
12-623	203	13-810	296	14-552	204	15-622	406	15G040	424	15G713	403	16-506	337
12-625	203	13-815	296	14-570	199	15-623	406	15G041	424	15G715	402	16-508	337
12-626	203	13-816	296	14-572	199	15-624	406	15G045	425	15G720	405	16-510	337
12-627	203	13-820	296	14-699	206	15-632	406	15G050	424	15G720-30	405	16-512	337
12-628	203	13-821	296	14-700	206	15-633	406	15G051	424	15G721	405	16-514	337
12 630	162	13-822	296	14-702	206	15-642	406	15G052	424	15G721-30	405	16B160	357
12-630	203	13-830	296	14-703	206	15-700	402	15G053	423	15G722	405	16B230	357
12 631	162	13-950	295	14-704	206	15-705	400	15G075	423	15G722-30	405	16B240	357
12-631	203	13-954	295	14-706	207	15-706	400	15G100	418	15G723	405	16B243	357
12 632	162	13-956	295	14-708	205	15-707	400	15G101	418	15G723-30	405	16B244	357

Ref	p.	Ref	p.	Ref	p.	Ref	p.	Ref	p.	Ref	p.	Ref	p.
16B260	357	18B304	291	21-021	144	25-152	261	29C504	308	32D111	117	34D065	142
16B271	357	18B305	291	21-022	144	25-153	261	29C505	308	32D112	117	34D067	142
16B272	357	18B306	291	21-023	144	25-154	261	29C506	308	32D113	118	34D110	138
16B273	357	18B308	291	21-024	144	25-155	261	29C507	308	32D114	118	34D111	138
16B282	357	18B310	291	21-025	144	25-157	261	29C601	308	32D115	118	34D112	138
16B316	358	18B312	291	21-026	144	25-161	260	29C602	308	32D116	118	34D120	139
16B318	358	18B330	291	21-027	144	25-162	260	29C603	308	32D118	119	34D121	139
16B322	358	18B436	292	21 127	161	26C005	304	29C604	308	32D119	119	34D122	139
16B324	358	18B437	292	21 127-950	161	26C006	304	29C605	308	32D120	120	34D130	138
16B328	358	18B526	360	21 163	191	26C011	304	29C606	308	32D121	119	34D131	138
16B330	358	18B527	360	21 165	191	26C012	304	29C607	308	32D130	124	34D301	143
16B420	361	18B550	361	21 167	191	27-006	419	29C871	309	32D131	124	34D305	143
16B430	361	18B604	291	21 169	191	27-008	419	29C872	309	32D138	119	34D308	143
16B440	361	18B605	291	21B131	359	27-010	419	29C873	309	32D141	274	34D512	137
16B441	361	18B606	291	21B235	359	27-012	419	29C893	308	32D301	124	34D513	137
16B450	361	18B607	291	21B245	359	27-019	419	29C894	308	32D302	124	34D614	139
16B451	361	18B610	291	21B330	358	27 030	193	29C897	309	32D304	124	34D615	139
16B460	361	18B612	291	21B330-1	358	27-030	419	29C902	309	32D306	124	34D701	138
16B471	360	19-151	348	21B336	358	27-031	419	29C908	309	32D307	124	34D702	138
16B471-1	360	19-152	348	21B360	358	27-032	419	29C909	309	32D308	124	34D703	138
16B472	292	19-153	348	21B501	359	27-033	420	30C217	315	32D309	124	34D761	138
16B476	315	19-200	347	21B503	360	27-050	421	30C320	316	32D320	124	34D762	138
16B480	362	19-220	347	21B504	359	27 070	193	30C321	317	32D401	119	35-010	274
17-083	338	19-225	347	21B507	360	27-120	420	30C330	316	32D402	133	35-012	274
17-084	338	19-904	346	21B509	360	27-121	420	30C333	316	32D404	133	35-015	274
17-090	338	19-905	346	21B510	360	27-123	420	30C335	316	32D405	130	35-026	275
17-095	338	19-906	347	23B145	302	27-124	420	30C343	317	32D406	131	35-030	274
17-096	338	19B116	300	23B175	302	27-201	421	30C345	317	32D407	119	35-035	275
17-097	338	19B117	300	23B203	364	27-202	421	30C347	317	32D408	133	35-040	275
17-100	338	19B118	300	23B204	364	27-203	421	30C614	313	32D409	133	35-430	300
17-113	339	19B610	300	23B205	364	27-211	421	30C615	313	32D410	133	35-431	300
17-154	339	19B615	300	23B222	364	27-212	421	30C616	295	32D413	366	35-432	300
17-155	339	19B620	300	23B224	364	27-213	421	30C617	295	32D420	343	35-433	300
17-172	339	19B625	300	23B257	331	27 622	193	30C630	313	32D421	126	35D030	88
17-173	339	19B630	300	23B258	331	27 632	193	30C643	313	32D422	343	35D031	88
17-180	340	19B640	300	23B259	331	27 846	193	31-018	271	32D423	135	35D032	88
17 786	192	20-005	345	24 110	161	27 846-950	193	31-019	271	32D 0	298	35D035	88
17 793	192	20-006	345	24B108	365	27C001	305	31-024	271	32D424	126	35D036	88
17B2H5	356	20-011	343	24B111	365	27C123	305	31-025	271	32D425	135	35D051	77
17B103	352	20-012	343	24B113	365	27C124	305	31-030	271	32D450	125	35D055	77
17B128	351	20-021	345	24B115	365	27C233	305	31-035	271	32D455	125	35D111	145
17B128Z	351	20-022	345	24B120	364	27C235	305	31-050	272	32D456	125	35D112	145
17B140	353	20-025	346	24B121	364	27C302	305	31-055	272	32D458	125	35D113	145
17B160	353	20-026	346	24B122	364	27C303	305	31-060	272	32D459	125	35D114	145
17B168	352	20-030	346	24B150	365	27C305	305	31-061	272	32D510	127	35D115	145
17B172	353	20-033	346	25-010	261	27C308	305	31-062	272	32D511	127	35D117	145
17B191	351	20-036	346	25-012	261	27C310	305	31-063	272	32D512	127	35D118	145
17B328	352	20-040	346	25-013	261	27C313	305	31-065	272	32D513	127	35D119	145
17B348	356	20-041	346	25-014	261	27C315	305	31-070	273	32D517	128	35D120	145
17B349	356	20-045	345	25-015	261	27C318	305	31-075	273	32D530	124	35D121	145
17B405	356	20-050	386	25-018	261	27C340	305	31-080	273	32D531	124	35D122	145
17B428	352	20-130	345	25-020	261	27C342	305	31-081	272	32D541	274	35D123	145
17B490	351	20B526	301	25-025	261	27C343	305	31-082	272	32D543	122	35D124	145
17B518	352	20B540	301	25-030	261	27C345	305	31-083	272	32D721	120	35D154	145
17B528	352	20B551	301	25-052	262	27C383	305	31-084	272	32D723	121	35D156	145
17B528-12	352	20B555	301	25-053	262	27C385	305	31-085	272	32D724	122	35D162	88
17B531	352	20B587	302	25-054	262	27C387	305	31-086	272	32D725	120	35D164	88
17B533	352	20B594	301	25-061	262	28C412	306	31C615	314	32D726	121	35D166	88
17B548	356	20B597	301	25-062	262	28C413	306	31C616	314	32D755	122	35D167	88
17B550	356	20B640	302	25-063	262	28C512	306	31C621	314	32D806	131	35D168	88
17B703	365	20B650	302	25-064	262	28C513	306	31C625	314	32D810	130	35D169	88
17B714	366	20B671	302	25-067	262	28C533	306	31C627	314	32D855	125	35D171	88
17B716	365	20B801	363	25-068	262	28C534	307	31C628	314	32D856	125	35D173	88
17B721	366	20B806	302	25-071	263	28C551	306	31C629	314	32D857	125	35D176	88
17B722	366	20B816	301	25-072	263	29-030	278	31C701	313	33-060	277	35D177	88
17B723	366	20B817	301	25-073	263	29-040	277	31C703	313	33-061	277	35D179	88
17B900	269	20B945	302	25-101	257	29-041	277	31C800	312	33-062	277	35D191	88
18 071	192	20B966	300	25-102	257	29-061	277	31C902	311	33-063	276	35D193	88
18-101	340	20B968	300	25-103	258	29-091	277	32D030	120	33-064	276	35D240	87
18-102	341	20B969	300	25-104	258	29-092	277	32D031	122	33-066	276	35D242	87
18-103	340	21-001	144	25-105	258	29-100	277	32D032	121	33-067	276	35D251	87
18-106	340	21-002	144	25-106	258	29-101	277	32D033	121	33-068	276	35D255	85
18-107	341	21-003	144	25-107	260	29C301	307	32D034	121	33-069	276	35D256	85
18 417 051	193	21-004	144	25-131	257	29C302	307	32D036	121	33-072	276	35D257	85
18 766 950	193	21-011	144	25-132	258	29C303	307	32D098	117	33-073	276	35D355	83
18B120	291	21-012	144	25-133	259	29C304	307	32D099	117	33-074	276	35D356	83
18B204	291	21-013	144	25-143	261	29C305	307	32D100	117	33-081	276	35D357	83
18B206	291	21-014	144	25-144	261	29C401	308	32D101	118	33-082	276	35D359	83
18B208	291	21-015	144	25-145	261	29C402	308	32D103	118	33-083	276	35D360	83
18B210	291	21-016	144	25-146	261	29C403	308	32D106	119	33-084	276	35D370	83
18B212	291	21-017	144	25-147	261	29C404	308	32D107	119	34D010	137	35D374	82
18B215	291	21-018	144	25-148	261	29C501	308	32D108	120	34D020	137	35D375	82
18B218	291	21-019	144	25-149	261	29C502	308	32D109	119	34D032	141	35D380	82
18B303	291	21-020	144	25-151	261	29C503	308	32D110	117	34D055	141	35D381	82

Ref	p.	Ref	p.	Ref	p.	Ref	p.	Ref	p.	Ref	p.	Ref	p.
35D382	82	35D937	88	38D101	68	39-201	297	39D476	110	41E905	336	44E111	343
35D383	82	35D938	88	38D121	68	39-202	297	39D477	110	41E906	336	44E115	343
35D384	82	35D939	88	38D141	68	39-203	297	39D479	110	41E908	336	44E117	344
35D385	82	35D940	88	38D142	54	39-204	297	39D480	110	41E915	337	44E118	344
35D386	82	35D941	88	38D143	54	39-250	297	39D503	95	42-100	418	44E120	343
35D387	82	35D950	79	38D147	54	39-251	297	39D504	92	42-101	418	44E121	344
35D388	82	35D951	79	38D151	107	39D011	90	39D506	93	42-102	418	44E122	344
35D389	82	35D952	79	38D152	69	39D012	90	39D516	96	42E081	340	44E123	344
35D390	82	35D954	76	38D159	69	39D016	91	39D518	103	42E110	340	44E139	345
35D391	82	35D955	76	38D215	60	39D017	91	39D522	104	42E113	340	44E141	345
35D392	82	35D956	76	38D224	60	39D018	91	39D551	98	42E151	340	44E142	345
35D393	82	35D957	76	38D296	54	39D019	91	39D552	98	42E152	340	44E143	345
35D394	82	35D958	76	38D300	87	39D054	115	39D555	100	42E171	340	44E148	345
35D395	82	35D959	78	38D500	61	39D055	115	39D556	109	42E172	340	44E150	346
35D396	82	35D960	78	38D501	67	39D058	115	39D558	98	42E173	340	44E154	345
35D397	82	35D961	78	38D502	68	39D066	115	39D559	98	42E180	340	44E512	349
35D455	86	35D962	76	38D505	54	39D067	115	39D640	90	42E181	340	44E514	349
35D555	145	35D963	77	38D510	61	39D081	180	39D641	90	42E182	340	44E517	349
35D556	145	35D964	78	38D515	56	39D082	180	39D642	90	42E500	339	44E519	349
35D557	145	35D966	76	38D520	55	39D104	93	39D643	90	42E501	339	44E522	349
35D558	145	35D967	76	38D521	67	39D105	95	39D644	90	42E511	338	44E524	349
35D596	85	35D968	78	38D522	68	39D106	95	39D645	90	42E521	339	44E532	349
35D597	85	35D969	78	38D525	55	39D122	100	39D650	91	42E522	339	44E731	349
35D605	85	37-022	278	38D530	55	39D150	111	39D651	91	42E580	339	44E742	349
35D607	85	37-122	278	38D535	61	39D155	111	39D652	91	42E581	339	44E745	349
35D609	85	37-222	278	38D540	68	39D173	108	39D655	91	43-300	266	44E812	349
35D611	85	37-322	278	38D541	67	39D174	95	39D656	91	43-301	266	44E816	349
35D613	85	37-422	278	38D542	68	39D177	96	39D673	111	43-302	266	44E950	349
35D615	85	37-540	279	38D543	68	39D179	95	39D674	112	43-310	266	44E952	349
35D619	85	37-545	279	38D545	61	39D180	103	39D771	97	43-320	270	44E954	349
35D623	85	37-550	279	38D550	55	39D181	103	39D772	97	43-321	270	44E956	349
35D630	83	37-600	279	38D552	69	39D183	101	39D773	97	43-350	269	44E958	349
35D632	83	37-605	278	38D553	69	39D185	105	39D774	97	43-355	269	44E960	349
35D633	83	37-610	278	38D554	69	39D193	98	39D775	97	43E100	342	45-220	281
35D635	83	37-800	280	38D555	69	39D194	98	39D776	97	43E101	342	45-230	281
35D636	83	37-810	280	38D556	69	39D197	100	39D778	97	43E111	342	45-240	281
35D655	85	37-812	280	38D557	68	39D200	106	39D801	90	43E133	342	45-450	281
35D656	85	37-814	280	38D558	68	39D250	92	39D802	90	43E134	342	45-451	281
35D657	85	37-816	280	38D570	56	39D251	92	39D803	90	43E135	342	45-452	281
35D700	145	37-818	280	38D640	53	39D252	92	39D804	90	43E136	342	45-453	281
35D740	84	37-820	280	38D642	54	39D253	92	39D806	90	43E301	342	45-454	281
35D741	84	37-824	280	38D650	53	39D254	92	39D820	90	43E302	342	45-455	281
35D743	84	37-832	280	38D652	53	39D255	92	39D821	90	43E401	342	45-456	281
35D744	84	37-838	280	38D669	53	39D256	92	39D822	90	43E402	342	45-457	281
35D745	84	37-900	280	38D710	64	39D260	92	39D823	90	43E403	342	45-490	282
35D746	84	37-910	280	38D712	64	39D261	92	39D830	91	43E404	342	45-491	282
35D747	84	37-912	280	38D713	64	39D263	92	39D831	91	43E405	342	45-493	282
35D748	84	37-914	280	38D714	64	39D264	92	39D842	91	43E421	342	45-495	283
35D749	84	37-916	280	38D715	64	39D314	108	39D843	91	43E501	342	45-496	283
35D750	84	37-918	280	38D716	64	39D337	107	39D844	91	43E502	342	45-500	281
35D755	83	37-920	280	38D717	64	39D338	107	39D845	91	43E503	342	45-501	281
35D756	83	37-924	280	38D718	64	39D339	107	39D860	107	43E504	342	45-502	281
35D757	83	37-932	280	38D719	64	39D340	107	39D865	100	43E505	342	45-503	281
35D758	83	37D051	166	38D721	64	39D341	107	39D886	95	43E507	342	45-504	281
35D759	83	37D052	166	38D722	64	39D342	73	39D930	95	43E509	342	45-505	281
35D763	83	37D105	81	38D724	64	39D343	100	39D933	95	43E701	341	45-520	283
35D807	86	37D205	160	38D727	64	39D344	105	41-091	269	43E703	341	45-521	283
35D809	86	37D207	160	38D730	64	39D346	105	41-111	264	43E707	341	45-522	283
35D811	86	37D221	166	38D732	64	39D350	103	41-116	264	43E712	341	45-523	283
35D813	86	37D222	166	38D751	64	39D351	103	41-131	264	43E713	341	45-530	283
35D815	86	37D305	165	38D753	64	39D352	105	41-136	264	43E780	341	45-531	283
35D817	86	37D310	165	38D755	64	39D355	103	41-141	264	43E790	342	45-532	283
35D821	86	37D313	165	38D756	64	39D356	104	41-161	264	43E791	342	45-533	283
35D823	86	37D405	169	38D757	64	39D357	106	41-166	264	44-600	266	49-905	294
35D855	86	37D406	169	38D760	64	39D358	104	41-201	269	44-610	265	49-910	294
35D856	86	37D410	168	38D761	64	39D361	104	41-226	268	44-611	265	49-915	294
35D904	76	37D501	174	38D762	64	39D363	103	41E006	337	44-612	265	49-920	294
35D905	76	37D502	174	38D763	64	39D369	105	41E008	337	44-613	265	49-931	294
35D906	76	37D503	174	38D764	166	39D375	73	41E010	337	44-618	270	50-101	284
35D907	76	37D504	174	38D765	166	39D377	74	41E012	337	44E000	348	50-102	284
35D908	76	37D505	174	38D805	73	39D378	73	41E014	337	44E002	348	50-111	284
35D910	76	37D506	174	38D808	73	39D381	103	41E306	337	44E003	348	50-112	284
35D912	76	37D507	174	38D850	54	39D382	108	41E308	337	44E004	348	50-113	284
35D913	76	37D508	174	39-010	296	39D383	103	41E310	337	44E005	348	50-121	284
35D914	76	37D509	174	39-011	296	39D385	106	41E312	337	44E006	349	50-122	284
35D917	76	37D510	174	39-012	296	39D386	106	41E314	337	44E007	348	50-123	284
35D919	76	37D511	174	39-030	296	39D387	107	41E406	337	44E024	347	50-131	284
35D930	88	37D512	174	39-031	296	39D389	104	41E408	337	44E026	347	50-132	284
35D931	88	37D513	174	39-032	296	39D456	104	41E410	337	44E029	347	50-133	284
35D932	88	37D514	174	39-050	296	39D470	110	41E412	337	44E030	347	50-134	284
35D933	88	37D515	174	39-051	296	39D471	110	41E414	337	44E031	347	50-136	284
35D934	88	37D516	174	39-052	296	39D472	110	41E901	337	44E107	347	50-137	284
35D935	88	37D517	174	39-100	296	39D473	110	41E903	336	44E108	347	50-138	284
35D936	88	37D518	174	39-200	297	39D475	110	41E904	337	44E110	343	50-139	284

Ref	p.	Ref	p.	Ref	p.	Ref	p.	Ref	p.	Ref	p.	Ref	p.
50-141	284	50-551	290	63-107	382	71-062	307	75-204	311	80-220-S	210	81-216-XXL	220
50-142	284	50-552	290	63-108	383	71-063	307	75-206	311	80-220-XL	210	81-216-XXXL	220
50-143	284	50-553	290	63-109	383	71-064	307	75-250	313	80-220-XXL	210	81-217-L	220
50-146	284	50-554	290	63-110	382	71-065	307	75-270	312	80-240-L	210	81-217-M	220
50-147	284	56-005	357	63-111	383	71-066	307	75-275	312	80-240-M	210	81-217-S	220
50-148	284	56-006	358	63-112	381	71-067	307	75-276	312	80-240-S	210	81-217-XL	220
50-151	284	56-007	365	63-113	381	71-081	307	77P505	191	80-240-XL	210	81-217-XS	220
50-152	284	56-008	365	63-114	382	71-082	307	77P530	161	80-240-XXL	210	81-217-XXL	220
50-155	284	56-010	356	63-115	382	71-083	307	79R100	323	80-500-L	222	81-217-XXXL	220
50-156	284	56-014	363	63-116	383	71-084	307	79R101	323	80-500-M	222	81-218-L	221
50-160	286	56-020	363	63-117	383	71-085	307	79R102	323	80-500-S	222	81-218-M	221
50-161	286	56-021	363	63-118	384	71-086	307	79R120	323	80-500-XL	222	81-218-S	221
50-162	287	56-022	363	63-119	384	71-087	307	79R121	323	80-500-XXL	222	81-218-XL	221
50-163	287	56-023	363	63-120	383	71-112	307	79R122	323	80-550-L	226	81-218-XXL	221
50-164	287	56-024	363	63-121	384	71-113	307	79R123	323	80-550-M	226	81-218-XXXL	221
50-166	286	56-025	363	63-122	384	71-114	307	79R124	323	80-550-S	226	81-220-L	213
50-167	287	56-026	363	63-123	388	71-116	307	79R125	323	80-550-XL	226	81-220-LD	213
50-168	287	56-027	363	63-124	388	71-122	307	79R129	323	80-550-XXL	226	81-220-M	213
50-169	287	56-028	364	63-125	387	71-123	307	79R131	323	80-555-L	223	81-220-S	213
50-171	286	56-029	364	63-126	386	71-124	307	79R132	323	80-555-M	223	81-220-XL	213
50-172	287	56-040	364	63-128	386	71-200	307	79R133	323	80-555-S	223	81-220-XXL	213
50-173	287	56-050	297	63-130	388	72-021	315	79R160	324	80-555-XL	223	81-221-L	211
50-174	287	56-053	297	63-131	385	72-022	315	79R163	324	80-555-XXL	223	81-221-M	211
50-181	286	56-054	298	63-132	388	72-023	315	79R174	324	80-610-L	231	81-221-S	211
50-182	287	56-800	299	63-135	388	72-024	315	79R175	324	80-610-M	231	81-221-XL	211
50-183	287	56-801	299	63-140	381	72-025	315	79R176	324	80-610-S	231	81-221-XS	211
50-191	286	56-802	299	63-141	388	72-031	315	79R177	324	80-610-XL	231	81-221-XXL	211
50-196	286	56-803	299	63-142	386	72-032	315	79R178	324	80-610-XXL	231	81-221-XXXL	211
50-201	286	56-805	299	63-143	386	72-033	315	79R182	331	80-611-L	231	81-222-L	211
50-202	287	56-806	299	63-144	387	72-034	315	79R183	331	80-611-M	231	81-222-M	211
50-203	287	56-820	298	63-145	387	72-035	315	79R184	331	80-611-S	231	81-222-S	211
50-204	287	56-821	298	63-146	387	72-102	316	79R186	331	80-611-XL	231	81-222-XL	211
50-205	287	56H820	251	63-147	387	72-105	316	79R187	299	80-611-XXL	231	81-222-XS	211
50-209	286	56H822	251	63-148	387	72-109	316	79R204	326	81-110-L	221	81-222-XXL	211
50-221	288	56H824	251	63-149	387	72-115	316	79R220	323	81-110-LD	221	81-222-XXXL	211
50-222	288	61-001	358	63-150	386	72-120	316	79R255	327	81-110-M	221	81-224-L	212
50-223	288	61-002	358	63-151	386	72-125	316	79R273	334	81-110-S	221	81-224-M	212
50-224	287	61-004	358	63-152	387	72-126	316	79R274	334	81-110-XL	221	81-224-S	212
50-225	287	61-005	358	63-153	380	72-127	316	79R275	334	81-110-XXL	221	81-224-XL	212
50-226	287	61-006	358	63-154	380	72-130	316	79R290	101	81-120-L	212	81-224-XS	212
50-231	289	61-011	359	63-155	388	72-145	316	79R300	332	81-120-LD	212	81-224-XXL	212
50-232	289	61-012	359	63-700	353	72-146	316	79R301	332	81-120-M	212	81-224-XXXL	212
50-241	289	61-013	359	63-702	353	72-147	316	79R302	333	81-120-S	212	81-225-L	212
50-251	292	61-014	359	63-710	353	72-200	315	79R305	333	81-120-XL	212	81-225-M	212
50-252	290	61-100	362	63-901	273	72-205	315	79R306	333	81-120-XXL	212	81-225-S	212
50-253	289	61-101	363	64-001	366	72-210	315	79R319	330	81-140-L	213	81-225-XL	212
50-254	289	61-102	362	64-010	355	72-213	315	79R351	334	81-140-LD	213	81-225-XXL	212
50-257	292	61-103	363	64-012	355	72-215	315	79R352	334	81-140-M	213	81-226-L	210
50-258	292	61-104	363	64-013	355	72-217	315	79R355	334	81-140-S	213	81-226-M	210
50-260	293	61-105	362	64-014	355	72-300	317	79R356	334	81-140-XL	213	81-226-S	210
50-262	289	61-106	362	64-015	356	72-320	317	79R357	334	81-140-XXL	213	81-226-XL	210
50-267	292	61-107	362	64-020	355	72-350	315	79R364	334	81-207-L	221	81-226-XS	210
50-268	292	61-108	362	64-210	355	72-351	315	79R365	334	81-207-M	221	81-226-XXL	210
50-281	290	61-109	362	64-220	356	72-523	308	79R367	334	81-207-S	221	81-226-XXXL	210
50-282	290	61-110	362	64-410	356	72-524	308	79R401	328	81-207-XL	221	81-227-L	210
50-291	287	61-111	362	64-420	356	72-525	308	79R402	328	81-207-XXL	221	81-227-M	210
50-292	287	61-112	362	64-610	356	72-543	308	79R405	328	81-207-XXXL	221	81-227-S	210
50-293	287	61-113	362	64-620	356	72-544	308	79R410	328	81-210-L	222	81-227-XL	210
50-294	287	61-114	362	67-111	304	72-545	308	79R415	329	81-210-LD	222	81-227-XS	210
50-295	287	61-115	362	67-112	304	72-553	308	79R416	329	81-210-M	222	81-227-XXL	210
50-304	291	61-116	362	67-113	304	72-554	308	79R420	328	81-210-S	222	81-227-XXXL	210
50-305	291	61-117	362	67-115	304	74-010	304	79R421	329	81-210-XL	222	81-228-L	214
50-306	291	61-118	362	67-183	304	74-020	304	79R430	329	81-210-XXL	222	81-228-M	214
50-351	291	61-119	362	67-185	304	75-000	314	79R431	329	81-211-L	221	81-228-S	214
50-352	291	61-120	362	67-188	304	75-001	314	79R432	329	81-211-M	221	81-228-XL	214
50-353	291	61-121	362	67-193	304	75-011	314	79R440	326	81-211-S	221	81-228-XS	214
50-354	291	61-122	362	67-195	304	75-100	310	79R441	326	81-211-XL	221	81-228-XXL	214
50-355	291	61-123	362	67-198	304	75-101	310	79R444	326	81-211-XXL	221	81-228-XXXL	214
50-356	291	63-011	351	67-203	304	75-102	311	79R447	327	81-211-XXXL	221	81-229-L	215
50-357	291	63-012	351	67-205	304	75-103	310	79R449	327	81-213-L	221	81-229-M	215
50-358	291	63-013	351	67-208	304	75-104	310	79R500	32	81-213-M	221	81-229-S	215
50-359	291	63-014	351	67-213	304	75-106	310	79R501	32	81-213-S	221	81-229-XL	215
50-360	291	63-015	353	67-215	304	75-107	310	79R502	32	81-213-XL	221	81-229-XS	215
50-400	293	63-016	353	67-218	304	75-108	310	79R510	33	81-213-XXL	221	81-229-XXL	215
50-410	293	63-017	353	68-030	306	75-109	310	79R511	33	81-213-XXXL	221	81-229-XXXL	215
50-420	292	63-021	351	68-050	306	75-110	311	79R512	33	81-215-L	221	81-230-L	213
50-421	292	63-025	382	68-051	306	75-113	311	79R513	33	81-215-M	221	81-230-LD	213
50-500	290	63-026	382	68-120	306	75-115	311	79R514	33	81-215-S	221	81-230-M	213
50-501	290	63-027	383	68-130	306	75-120	312	79R515	33	81-215-XL	221	81-230-S	213
50-502	290	63-050	351	68-150	306	75-121	312	79R516	34	81-215-XXL	221	81-230-XL	213
50-503	290	63-060	351	68-151	306	75-130	312	79R517	34	81-216-L	220	81-230-XXL	213
50-504	290	63-100	383	71-001	307	75-131	312	79R518	34	81-216-M	220	81-231-L	211
50-531	290	63-105	382	71-030	307	75-202	311	80-220-L	210	81-216-S	220	81-231-M	211
50-550	290	63-106	382	71-061	307	75-203	311	80-220-M	210	81-216-XL	220	81-231-S	211

Ref	p.	Ref	p.	Ref	p.	Ref	p.	Ref	p.	Ref	p.	Ref	p.
81-231-XL	211	81-247-L	210	81-310-XXL	222	81-506-M	222	81-556-M	224	81-603-XXL	230	81-648-M	229
81-231-XS	211	81-247-M	210	81-311-L	222	81-506-S	222	81-556-S	224	81-603-XXXL	230	81-648-S	229
81-231-XXL	211	81-247-S	210	81-311-M	222	81-506-XL	222	81-556-XL	224	81-604-L	230	81-648-XL	229
81-231-XXXL	211	81-247-XL	210	81-311-S	222	81-506-XXL	222	81-556-XXL	224	81-604-M	230	81-648-XXL	229
81-233-L	214	81-247-XS	210	81-311-XL	222	81-506-XXXL	222	81-556-XXXL	224	81-604-S	230	81-648-XXXL	229
81-233-M	214	81-247-XXL	210	81-311-XXL	222	81-511-L	223	81-557-L	228	81-604-XL	230	81-649-L	229
81-233-S	214	81-247-XXXL	210	81-311-XXXL	222	81-511-M	223	81-557-M	228	81-604-XXL	230	81-649-M	229
81-233-XL	214	81-248-L	213	81-321-L	214	81-511-S	223	81-557-S	228	81-604-XXXL	230	81-649-S	229
81-233-XS	214	81-248-M	213	81-321-M	214	81-511-XL	223	81-557-XL	228	81-606-L	232	81-649-XL	229
81-233-XXL	214	81-248-S	213	81-321-S	214	81-511-XXL	223	81-557-XXL	228	81-606-M	232	81-649-XXL	229
81-233-XXXL	214	81-248-XL	213	81-321-XL	214	81-511-XXXL	223	81-557-XXXL	228	81-606-S	232	81-649-XXXL	229
81-236-L	214	81-248-XS	213	81-321-XS	214	81-512-L	224	81-558-L	226	81-606-XL	232	81-652-L	230
81-236-M	214	81-248-XXL	213	81-321-XXL	214	81-512-M	224	81-558-M	226	81-606-XXL	232	81-652-M	230
81-236-S	214	81-248-XXXL	213	81-321-XXXL	214	81-512-S	224	81-558-S	226	81-606-XXXL	232	81-652-S	230
81-236-XL	214	81-250-L	216	81-325-L	214	81-512-XL	224	81-558-XL	226	81-610-L	231	81-652-XL	230
81-236-XS	214	81-250-LD	216	81-325-M	214	81-512-XXL	224	81-558-XXL	226	81-610-M	231	81-652-XXL	230
81-236-XXL	214	81-250-M	216	81-325-S	214	81-512-XXXL	224	81-559-L	226	81-610-S	231	81-652-XXXL	230
81-236-XXXL	214	81-250-S	216	81-325-XL	214	81-520-L	233	81-559-M	226	81-610-XL	231	81-657-L	232
81-237-L	211	81-250-XL	216	81-325-XS	214	81-520-M	233	81-559-S	226	81-610-XXL	231	81-657-M	232
81-237-M	211	81-250-XXL	216	81-325-XXL	214	81-520-S	233	81-559-XL	226	81-612-L	230	81-657-S	232
81-237-S	211	81-258-L	216	81-325-XXXL	214	81-520-XL	233	81-559-XXL	226	81-612-M	230	81-657-XL	232
81-237-XL	211	81-258-M	216	81-330-L	219	81-330-LD	219	81-520-XXXL	233	81-612-S	230	81-657-XXL	232
81-237-XS	211	81-258-S	216	81-330-LD	219	81-330-M	219	81-530-L	233	81-612-XL	230	81-657-XXXL	232
81-237-XXL	211	81-258-XL	216	81-330-M	219	81-330-S	219	81-530-L	233	81-612-XXL	230	81-659-L	232
81-237-XXXL	211	81-258-XS	216	81-330-S	219	81-331-L	219	81-530-M	233	81-613-L	231	81-659-M	232
81-238-L	213	81-258-XXL	216	81-331-L	219	81-331-M	219	81-530-S	233	81-613-M	231	81-659-S	232
81-238-M	213	81-258-XXXL	216	81-331-M	219	81-331-S	219	81-530-XL	233	81-613-S	231	81-659-XL	232
81-238-S	213	81-260-L	234	81-331-S	219	81-331-XL	219	81-530-XXL	233	81-613-XL	231	81-659-XXL	232
81-238-XL	213	81-260-M	234	81-331-XL	219	81-331-XS	219	81-532-L	233	81-613-XXL	231	81-659-XXXL	232
81-238-XS	213	81-260-S	234	81-331-XS	219	81-331-XXL	219	81-532-M	233	81-614-L	229	81-660-L/XL	235
81-238-XXL	213	81-260-XL	234	81-331-XXL	219	81-331-XXXL	219	81-532-S	233	81-614-M	229	81-660-S/M	235
81-238-XXXL	213	81-260-XXL	234	81-331-XXXL	219	81-410-L	222	81-532-XL	233	81-614-S	229	81-660-XXL/XXXL	235
81-239-L	213	81-268-L	234	81-410-L	222	81-410-LD	222	81-532-XXL	233	81-614-XL	229	81-661-L/XL	235
81-239-M	213	81-268-M	234	81-410-LD	222	81-410-M	222	81-532-XXXL	233	81-614-XXL	229	81-661-S/M	235
81-239-S	213	81-268-S	234	81-410-M	222	81-410-S	222	81-533-L	233	81-614-XXXL	229	81-661-XXL/XXXL	235
81-239-XL	213	81-268-XL	234	81-410-S	222	81-410-XL	222	81-533-M	233	81-615-L	231	81-662-L/XL	235
81-239-XS	213	81-268-XXL	234	81-410-XL	222	81-420-L	215	81-533-S	233	81-615-M	231	81-662-S/M	235
81-239-XXL	213	81-268-XXXL	234	81-410-XXL	222	81-420-LD	215	81-533-XL	233	81-615-XXL	231	81-662-XXL/XXXL	235
81-239-XXXL	213	81-270-L	219	81-420-L	215	81-420-LD	215	81-533-XXL	233	81-615-XL	231	81-663-L/XL	235
81-240-L	214	81-270-LD	219	81-420-LD	215	81-420-LD	215	81-534-L	233	81-615-XXL	231	81-663-S/M	235
81-240-LD	214	81-270-M	219	81-420-M	215	81-420-M	215	81-534-M	233	81-619-L	232	81-663-XXL/XXXL	235
81-240-M	214	81-270-S	219	81-420-S	215	81-420-S	215	81-534-S	233	81-619-M	232	81-670-L/XL	235
81-240-S	214	81-270-XL	219	81-420-XL	215	81-420-XL	215	81-534-XL	233	81-619-S	232	81-670-S/M	235
81-240-XL	214	81-270-XXL	219	81-420-XXL	215	81-430-L	215	81-534-XXL	233	81-619-XXL	232	81-670-XXL/XXXL	235
81-240-XXL	214	81-271-L	219	81-430-L	215	81-430-LD	215	81-534-XXXL	233	81-619-XXL	232	81-671-L/XL	235
81-241-L	211	81-271-M	219	81-430-LD	215	81-430-M	215	81-540-L	234	81-619-XXXL	232	81-671-S/M	235
81-241-M	211	81-271-S	219	81-430-M	215	81-430-M	215	81-540-M	234	81-620	236	81-671-XXL/XXXL	235
81-241-S	211	81-271-XL	219	81-430-S	215	81-430-S	215	81-540-M	234	81-621	236	81-672-L/XL	235
81-241-XL	211	81-271-XS	219	81-430-S	215	81-430-S	215	81-540-S	234	81-622	236	81-672-S/M	235
81-241-XS	211	81-271-XXL	219	81-430-XXL	215	81-430-XXL	215	81-540-XL	234	81-623	236	81-672-XXL/XXXL	235
81-241-XXL	211	81-271-XXXL	219	81-440-L	219	81-440-L	219	81-540-XL	234	81-624	236	81-673-L/XL	235
81-241-XXXL	211	81-273-L	218	81-440-LD	219	81-440-LD	219	81-541-L	227	81-625	236	81-673-S/M	235
81-242-L	211	81-273-M	218	81-440-LD	219	81-440-M	219	81-541-M	234	81-626	236	81-673-XXL/XXXL	235
81-242-M	211	81-273-S	218	81-440-M	219	81-440-M	219	81-541-S	234	81-627	236	81-700-L	225
81-242-S	211	81-273-XL	218	81-440-S	219	81-440-S	219	81-541-XL	234	81-628	237	81-700-M	225
81-242-XL	211	81-273-XS	218	81-440-XXL	219	81-440-XXL	219	81-541-XXL	234	81-630	236	81-700-S	225
81-242-XS	211	81-273-XXL	218	81-450-L	215	81-450-L	215	81-549-L	234	81-631	236	81-700-XL	225
81-242-XXL	211	81-273-XXXL	218	81-450-L	215	81-450-M	215	81-549-M	234	81-632	236	81-700-XXL	225
81-242-XXXL	211	81-276-L	218	81-450-M	215	81-450-M	215	81-549-S	234	81-640-L	230	81-700-XXXL	225
81-243-L	212	81-276-L	218	81-450-S	215	81-450-S	215	81-549-S	234	81-640-M	230	81-701-L	225
81-243-M	212	81-276-M	218	81-450-XL	215	81-450-XL	215	81-549-S	234	81-640-XL	230	81-701-M	225
81-243-S	212	81-276-S	218	81-450-XXL	215	81-450-XXL	215	81-549-S	234	81-640-XXL	230	81-701-S	225
81-243-XL	212	81-276-XL	218	81-450-XXXL	215	81-451-L	215	81-549-S	234	81-640-XXXL	230	81-701-XXL	225
81-243-XS	212	81-276-XS	218	81-451-L	215	81-451-L	215	81-550-L	226	81-641-L	230	81-701-XL	225
81-243-XXL	212	81-276-XXL	218	81-451-M	215	81-451-M	215	81-550-M	226	81-641-M	230	81-701-XXL	225
81-243-XXXL	212	81-276-XXXL	218	81-451-S	215	81-451-S	215	81-550-S	226	81-641-XL	230	81-701-XXXL	225
81-244-L	212	81-278-L	219	81-451-XXL	215	81-451-XXL	215	81-550-XXL	226	81-642-L	230	81-710-L	228
81-244-M	212	81-278-M	219	81-451-XXL	215	81-451-XXXL	215	81-551-L	226	81-642-L	230	81-710-M	228
81-244-S	212	81-278-S	219	81-451-XXXL	215	81-500-L	223	81-551-M	226	81-642-M	230	81-710-S	228
81-244-XL	212	81-278-XL	219	81-500-L	223	81-500-M	223	81-551-S	226	81-642-XL	230	81-710-XXL	228
81-244-XS	212	81-278-XS	219	81-500-M	223	81-500-S	223	81-551-XL	226	81-642-XXL	230	81-710-XXXL	228
81-244-XXL	212	81-278-XXL	219	81-500-S	223	81-500-S	223	81-551-XXL	226	81-642-XXL	230	81-711-L	228
81-244-XXXL	212	81-278-XXXL	219	81-500-XXL	223	81-500-XXL	223	81-551-XXXL	226	81-642-XXXL	230	81-711-M	228
81-245-L	212	81-279-L	218	81-500-XXL	223	81-501-L	223	81-553-L	226	81-643-L	230	81-711-S	228
81-245-M	212	81-279-M	218	81-501-L	223	81-501-L	223	81-553-M	226	81-643-M	230	81-711-XL	228
81-245-S	212	81-279-S	218	81-501-M	223	81-501-M	223	81-553-S	226	81-643-XL	230	81-711-XXL	228
81-245-XL	212	81-279-XL	218	81-501-S	223	81-501-S	223	81-553-XXL	226	81-643-XXL	230	81-711-XXXL	228
81-245-XS	212	81-279-XS	218	81-501-XXL	223	81-501-XXL	223	81-602-L	231	81-643-XXXL	230	81-720-L	228
81-245-XXL	212	81-279-XXL	218	81-501-XXXL	223	81-505-L	223	81-602-M	231	81-647-L	229	81-720-M	228
81-246-L	210	81-279-XXL	218	81-505-L	223	81-505-M	223	81-602-S	231	81-647-M	229	81-720-S	228
81-246-M	210	81-310-L	222	81-505-M	223	81-505-S	223	81-602-S	231	81-647-S	229	81-720-XL	228
81-246-S	210	81-310-LD	222	81-505-S	223	81-5							



Ref	p.	Ref	p.	Ref	p.	Ref	p.	Ref	p.	Ref	p.	Ref	p.
81-730-M	232	81-777-L	217	82-036	238	82-142	240	82-165-41	241	82-718	242	82S160	250
81-730-S	232	81-777-M	217	82-037	238	82-143	240	82-165-42	241	82-720	242	82S161	250
81-730-XL	232	81-777-S	217	82-038	238	82-144	240	82-165-43	241	82-721	242	82S162	250
81-730-XXL	232	81-777-XL	217	82-040	240	82-145	240	82-165-44	241	82-722	242	82S210	251
81-731-L	232	81-777-XXL	217	82-041	240	82-146	240	82-165-45	241	82-723	242	82S211	251
81-731-M	232	81-778-L	217	82-042	240	82-147	240	82-165-46	241	82-724	242	82S220	251
81-731-S	232	81-778-M	217	82-043	240	82-148	240	82-165-47	241	82-725	242	83S201	254
81-731-XL	232	81-778-S	217	82-044	240	82-150-39	237	82-166-39	240	82-726	242	83S202	254
81-731-XXL	232	81-778-XL	217	82-045	240	82-150-40	237	82-166-40	240	82-727	242	83S203	254
81-732-L	232	81-778-XXL	217	82-046	240	82-150-41	237	82-166-41	240	82-728	242	83S213	254
81-732-M	232	81-779-L	216	82-047	240	82-150-42	237	82-166-42	240	82-730	242	84-060	321
81-732-S	232	81-779-M	216	82-048	240	82-150-43	237	82-166-43	240	82-731	242	84-061	321
81-732-XL	232	81-779-S	216	82-070-39	241	82-150-44	237	82-166-44	240	82-732	242	84-062	321
81-732-XXL	232	81-779-XL	216	82-070-40	241	82-150-45	237	82-166-45	240	82-733	242	84-064	321
81-735-L	233	81-779-XXL	216	82-070-41	241	82-150-46	237	82-166-46	240	82-734	242	84-065	321
81-735-XL	233	81-780-L	220	82-070-42	241	82-150-47	237	82-166-47	240	82-735	242	84-066	321
81-735-XXL	233	81-780-M	220	82-070-43	241	82-151-39	240	82-170-39	239	82-736	242	84-092	34
81-736	233	81-780-S	220	82-070-44	241	82-151-40	240	82-170-40	239	82-737	242	84-093	34
81-740-L	225	81-780-XL	220	82-070-45	241	82-151-41	240	82-170-41	239	82-738	242	84-094	34
81-740-M	225	81-780-XXL	220	82-070-46	241	82-151-42	240	82-170-42	239	82-740-39	241	84-095	34
81-740-S	225	81-781-L	220	82-070-47	241	82-151-43	240	82-170-43	239	82-740-40	241	84-096	34
81-740-XL	225	81-781-M	220	82-079-39	241	82-151-44	240	82-170-44	239	82-740-41	241	84-097	34
81-740-XXL	225	81-781-S	220	82-079-40	241	82-151-45	240	82-170-45	239	82-740-42	241	84-098	34
81-741-L	225	81-781-XL	220	82-079-41	241	82-151-46	240	82-170-46	239	82-740-43	241	84-100	322
81-741-M	225	81-781-XXL	220	82-079-42	241	82-151-47	240	82-170-47	239	82-740-44	241	84-101	322
81-741-S	225	81-782-L	220	82-079-43	241	82-155-39	238	82-175-39	239	82-740-45	241	84-102	322
81-741-XL	225	81-782-M	220	82-079-44	241	82-155-40	238	82-175-40	239	82-740-46	241	84-105	322
81-741-XXL	225	81-782-S	220	82-079-45	241	82-155-41	238	82-175-41	239	82-740-47	241	84-114	322
81-742-L	224	81-782-XL	220	82-079-46	241	82-155-42	238	82-175-42	239	82-750-39	242	84-115	322
81-742-M	224	81-782-XXL	220	82-079-47	241	82-155-43	238	82-175-43	239	82-750-40	242	84-116	322
81-742-S	224	81-783-L	220	82-080-39	241	82-155-44	238	82-175-44	239	82-750-41	242	84-118	324
81-742-XL	224	81-783-M	220	82-080-40	241	82-155-45	238	82-175-45	239	82-750-42	242	84-119	324
81-742-XXL	224	81-783-S	220	82-080-41	241	82-155-46	238	82-175-46	239	82-750-43	242	84-130	324
81-742-XXXL	224	81-783-XL	220	82-080-42	241	82-155-47	238	82-175-47	239	82-750-44	242	84-131	324
81-745-L	225	81-783-XXL	220	82-080-43	241	82-156-36	238	82-300	244	82-750-45	242	84-140	334
81-745-M	225	81-792-L	217	82-080-44	241	82-156-37	238	82-302	244	82-750-46	242	84-141	333
81-745-S	225	81-792-M	217	82-080-45	241	82-156-38	238	82-303	244	82-750-47	242	84-142	331
81-745-XL	225	81-792-S	217	82-080-46	241	82-156-39	238	82-310	244	82-760-36	241	84-143	331
81-745-XXL	225	81-792-XL	217	82-080-47	241	82-156-40	238	82-311	244	82-760-37	241	84-144	330
81-746-L	225	81-792-XXL	217	82-090	239	82-156-41	238	82-312	244	82-760-38	241	84-145	299
81-746-M	225	81-792-XXXL	217	82-091	239	82-156-42	238	82-313	244	82-760-39	241	84-217	25
81-746-S	225	81-793	236	82-092	239	82-156-43	238	82-314	244	82-760-40	241	84-217+G	25
81-746-XL	225	81-794	236	82-093	239	82-156-44	238	82-320	244	82-760-41	241	84-218	31
81-746-XXL	225	81-800-L	229	82-094	239	82-156-45	238	82-321	244	82-760-42	241	84-220	26
81-750-L	217	81-800-M	229	82-095	239	82-156-46	238	82-322	244	82-760-43	241	84-220+G	26
81-750-M	217	81-800-XL	229	82-096	239	82-156-47	238	82-323	244	82-760-44	241	84-221	27
81-750-S	217	81-800-XXL	229	82-097	239	82-157-39	238	82-324	244	82-760-45	241	84-221+G	27
81-750-XL	217	81-800-XXXL	229	82-098	239	82-157-40	238	82-350	244	82-760-46	241	84-222	27
81-750-XXL	217	81-810-L	229	82-100	239	82-157-41	238	82-351	244	82-760-47	241	84-222+G	27
81-750-XXXL	217	81-810-M	229	82-101	239	82-157-42	238	82-355	244	82-770-36	242	84-223	26
81-751-L	217	81-810-XL	229	82-102	239	82-157-43	238	82-356	244	82-770-37	242	84-223+G	26
81-751-M	217	81-810-XXL	229	82-103	239	82-157-44	238	82-360	244	82-770-38	242	84-225	25
81-751-S	217	81-810-XXXL	229	82-104	239	82-157-45	238	82-361	244	82-770-39	242	84-225+G	25
81-751-XL	217	81-811-L	216	82-105	239	82-157-46	238	82-365	244	82-770-40	242	84-229	28
81-751-XXL	217	81-811-M	216	82-106	239	82-157-47	238	82-366	244	82-770-41	242	84-230	28
81-751-XXXL	217	81-811-XL	216	82-107	239	82-158-39	238	82-530-36	237	82-770-42	242	84-231	29
81-760-L	218	81-811-XXL	216	82-108	239	82-158-40	238	82-530-37	237	82-770-43	242	84-232	29
81-760-M	218	81-811-XXXL	216	82-110	239	82-158-41	238	82-530-38	237	82-770-44	242	84-233	30
81-760-S	218	81-900	255	82-111	239	82-158-42	238	82-530-39	237	82-770-45	242	84-234	30
81-760-XL	218	81-901	255	82-112	239	82-158-43	238	82-530-40	237	82-770-46	242	84-235	30
81-760-XXL	218	82-010	238	82-113	239	82-158-44	238	82-530-41	237	82-770-47	242	84-236	30
81-760-XXXL	218	82-011	238	82-114	239	82-158-45	238	82-540-36	237	82-900-40	243	84-237	29
81-770-L	218	82-012	238	82-115	239	82-158-46	238	82-540-37	237	82-900-41	243	84-238	29
81-770-M	218	82-013	238	82-116	239	82-158-47	238	82-540-38	237	82-900-42	243	84-239	29
81-770-S	218	82-014	238	82-117	239	82-159-39	237	82-540-39	237	82-900-43	243	84-240	28
81-770-XL	218	82-015	238	82-118	239	82-159-40	237	82-540-40	237	82-900-44	243	84-241	30
81-770-XXL	218	82-016	238	82-120	240	82-159-41	237	82-540-41	237	82-900-45	243	84-242	28
81-770-XXXL	218	82-017	238	82-121	240	82-159-42	237	82-700	242	82-900-46	243	84-243	30
81-771-L	218	82-018	238	82-122	240	82-159-43	237	82-701	242	82-900-47	243	84-244	28
81-771-M	218	82-020	240	82-123	240	82-159-44	237	82-702	242	82-901-40	243	84-246	31
81-771-S	218	82-021	240	82-124	240	82-159-45	237	82-703	242	82-901-41	243	84-247	29
81-771-XL	218	82-022	240	82-125	240	82-159-46	237	82-704	242	82-901-42	243	84-249	31
81-771-XXL	218	82-023	240	82-126	240	82-159-47	237	82-705	242	82-901-43	243	84-255	320
81-771-XXXL	218	82-024	240	82-127	240	82-160-39	239	82-706	242	82-901-44	243	84-256	320
81-775-L	216	82-025	240	82-128	240	82-160-40	239	82-707	242	82-901-45	243	84-257	320
81-775-M	216	82-026	240	82-131	243	82-160-41	239	82-708	242	82-901-46	243	84-259	319
81-775-S	216	82-027	240	82-132	243	82-160-42	239	82-710	242	82S101	246	84-266	320
81-775-XL	216	82-028	240	82-133	243	82-160-43	239	82-711	242	82S102	247	84-267	320
81-775-XXL	216	82-030	238	82-134	243	82-160-44	239	82-712	242	82S105	246	84-268	320
81-776-L	217	82-031	238	82-135	243	82-160-45	239	82-713	242	82S131	245	84-269	320
81-776-M	217	82-032	238	82-136	243	82-160-46	239	82-714	242	82S132	245	84-271	31
81-776-S	217	82-033	238	82-137	243	82-160-47	239	82-715	242	82S133	245	84-274	31
81-776-XL	217	82-034	238	82-140	240	82-165-39	241	82-716	242	82S137	245</		

Ref	p.	Ref	p.	Ref	p.	Ref	p.	Ref	p.	Ref	p.
84-281	319	90-109	396	97-205	247	97-620-9	252	97X300	162	99-200	371
84-286	320	90-121	397	97-210	247	97-620-10	252	98Z007	354	99-201	371
84-287	320	90-122	397	97-211	247	97-621-8	252	98Z017	354	GD04	434
84-300	325	90-125	397	97-220	247	97-621-9	252	98Z027	355	GD05	434
84-301	325	90-127	397	97-221	247	97-621-10	252	98Z058	355	GD06	434
84-302	327	90-130	398	97-222	247	97-630-8	252	98Z101	354	GD07	434
84-303	325	90-132	398	97-223	247	97-630-9	252	98Z102	354	GD08	434
84-304	325	90-140	389	97-224	247	97-630-10	252	98Z103	354	GD09	433
84-305	325	90-141	389	97-225	247	97-631-8	252	98Z105	354	GD010	434
84-306	327	90-142	389	97-300	245	97-631-9	252	98Z106	354	GD012	433
84-308	325	90-143	389	97-301	245	97-631-10	252	98Z107	354	GD013	433
84-311	327	90-144	389	97-311	245	97-640-8	252	98Z110	354	GD014	433
84-315	326	90-145	390	97-321	245	97-640-9	252	98Z116	355	GD015	433
84-321	384	90-146	390	97-336	245	97-640-10	252	98Z146	398	GD016	433
84-322	384	90-147	390	97-336-20	245	97-641-8	252	98Z147	398	GD017	433
84-323	385	90-148	390	97-337	245	97-641-9	252	99-026	370	GD018	433
84-324	385	90-149	390	97-337-20	245	97-641-10	252	99-027	370	GD019	433
84-325	385	90-150	390	97-338	245	97-642-8	252	99-028	370	GD020	433
84-326	385	90-160	398	97-338-20	245	97-642-9	252	99-029	370	GD021	434
84-330	328	90-161	398	97-350	244	97-642-10	252	99-030	371	GD022	434
84-332	328	90-162	398	97-360	244	97-643-8	252	99-031	371	GD023	434
84-333	329	90U108	430	97-361	244	97-643-9	252	99-032	369	GD024	433
84-334	329	90U109	430	97-362	244	97-643-10	252	99-033	368	GD025	434
84-335	328	90U212	430	97-391	251	97-644-3	254	99-034	368	GD026	434
84-350	320	90U214	430	97-392	251	97-644-4	254	99-035	368	GD027	434
84-401	332	90U245	431	97-500	246	97-644-5	254	99-036	368	GD028	434
84-402	332	90U250	431	97-501	246	97-650	253	99-037	368	K112945	397
84-403	332	90U256	431	97-502	246	97-651	253	99-038	372	K112946	397
84-404	28	90U263	430	97-503	246	97-652	253	99-040	372	K112947	397
84-405	332	90U270	430	97-504	246	97-653	254	99-041	372	K112948	397
84-500	330	90U271	430	97-505	246	97-655-8	253	99-042	372	K112950	397
84-501	330	90U272	430	97-506	246	97-655-9	253	99-043	372	K112951	397
84-502	330	90U273	430	97-507	246	97-655-10	253	99-044	372		
84-503	330	90U280	430	97-508	246	97-656-8	253	99-045	369		
90-001	392	90U281	430	97-510	246	97-656-9	253	99-047	373		
90-002	392	90U300	430	97-511	247	97-656-10	253	99-048	373		
90-003	392	90U301	430	97-512	247	97-657-8	253	99-049	374		
90-004	392	90U302	430	97-513	247	97-657-9	253	99-050	374		
90-007	392	90U303	430	97-514	247	97-657-10	253	99-051	375		
90-008	392	90U304	430	97-530	251	97-674	251	99-052	375		
90-009	392	90U330	430	97-535	250	97-690-L	254	99-053	375		
90-010	392	90U332	430	97-536	250	97-690-M	254	99-054	375		
90-030	393	90U333	430	97-537	250	97-690-XL	254	99-055	378		
90-031	393	90U460	430	97-538	250	97-691-L	254	99-057	378		
90-032	393	91-000	436	97-550	249	97-691-M	254	99-058	378		
90-033	394	91-001	436	97-551	249	97-691-XL	254	99-059	376		
90-034	393	91-002	436	97-552	249	97G100	254	99-060	376		
90-035	393	91-003	436	97-553	250	97H120	427	99-061	376		
90-036	394	91-004	436	97-554	250	97H121	427	99-062	376		
90-037	393	91-005	436	97-555	249	97H122	427	99-063	375		
90-038	393	91-006	437	97-560	249	97H136	427	99-064	372		
90-039	393	91-007	437	97-561	249	97H137	427	99-065	373		
90-060	394	91-008	437	97-562	249	97H138	427	99-066	373		
90-061	394	91-009	436	97-563	249	97H140	427	99-067	369		
90-062	394	91-010	438	97-564	249	97H141	427	99-068	369		
90-063	394	91-011	437	97-565	249	97H142	427	99-069	370		
90-064	394	91-012	437	97-567	249	97H143	427	99-070	369		
90-065	394	91-013	437	97-590	248	97H144	427	99-071	373		
90-066	394	91-014	438	97-602	254	97H145	427	99-072	373		
90-067	394	91-015	437	97-603	253	97H146	427	99-073	370		
90-068	394	91-016-L	436	97-604	253	97H147	427	99-074	369		
90-069	394	91-016-M	436	97-605	253	97H148	427	99-075	369		
90-070	395	91-016-XL	436	97-606	253	97H151	427	99-076	374		
90-071	395	94-001	136	97-609-8	252	97H152	427	99-077	374		
90-080	395	94-002	136	97-609-9	252	97H153	427	99-078	369		
90-081	395	94-003	136	97-609-10	252	97H200	428	99-079	377		
90-082	395	94-004	136	97-610-8	252	97H201	428	99-080	377		
90-083	395	94W104	136	97-610-9	252	97H300	428	99-081	377		
90-084	395	94W105	136	97-610-10	252	97X072	182	99-082	377		
90-085	395	94W120	313	97-611	253	97X080	182	99-083	377		
90-090	396	94W245	374	97-612-8	253	97X082	182	99-084	377		
90-091	396	94W390	371	97-612-9	253	97X085	182	99-085	377		
90-092	396	94W391	371	97-612-10	253	97X087	182	99-086	377		
90-093	396	95-007	422	97-613-8	253	97X183	334	99-087	377		
90-094	396	95-008	422	97-613-9	253	97X184	334	99-088	378		
90-095	396	95-011	423	97-613-10	253	97X185	334	99-089	378		
90-102	396	97-100	248	97-615	254	97X186	334	99-090	378		
90-103	396	97-101	248	97-616-8	252	97X192	334	99-091	378		
90-104	396	97-102	248	97-616-9	252	97X195	334	99-092	378		
90-105	396	97-200	247	97-616-10	252	97X198	333	99-093	375		
90-106	396	97-201	247	97-617-8	252	97X199	333	99-094	374		
90-107	396	97-202	247	97-617-9	252	97X206	333	99-095	376		
90-108	396	97-203	247	97-617-10	252	97X250	179	99-096	376		
90-108-1	396	97-204	247	97-620-8	252	97X269	184	99-101	368		



Grupa Topex Sp. z o.o. Sp.k.  
ul. Pograniczna 2/4,  
02-285 Warszawa  
tel. +48 22 573 03 00  
fax +48 22 573 04 00  
office@grupatopex.com



Україна

ТОВ «Топекс Україна»  
07400, м. Бровари,  
вул. О.Онiкiєнка, буд. 134,  
тел +38050-388-51-98  
office@topex.ua



Romania

Topex Tools Romania SRL  
tel: 0040 37 2740 619  
fax: 0040 37 2870 177  
romania@grupatopex.com

Grupa Topex nie ponosi żadnej odpowiedzialności za możliwe błędy w katalogach, broszurach i innych materiałach drukowanych. Grupa Topex zastrzega sobie prawo do dokonywania zmian w produktach bez uprzedzenia. Dotyczy to również produktów już zamówionych. Zamienniki mogą być dostarczone bez dokonywania jakichkolwiek zmian w specyfikacjach już uzgodnionych. Wszystkie znaki towarowe w tym materiale są własnością odpowiednich firm. Znaki towarowe GRAPHITE, VERTO, NEO, Top Tools są własnością "Grupa Topex Sp. z o.o." Sp.k. Niniejszy katalog ma jedynie charakter informacyjny i nie stanowi oferty zawarcia umowy. Zdjęcia umieszczone w katalogu są zdjęciami poglądowymi i produkty w rzeczywistości mogą się nieznacznie różnić od zamieszczonych ilustracji. Publikacja chroniona prawem autorskim. Kopiowanie, przedrukowywanie i rozpowszechnianie całości lub fragmentów, również na nośnikach magnetycznych lub elektronicznych bez zgody firmy Grupa Topex jest zabronione.

Grupa Topex shall not be held liable for any errors in catalogues, brochures and other printed materials. Grupa Topex stipulates the right to modify the products without prior notice. This shall also apply to products already ordered. Replacements may be delivered without any modifications of specifications already agreed upon. All trademarks, inclusive of those contained in this material, are the property of relevant companies. GRAPHITE, VERTO, NEO, Top Tools trademarks are the property of "Grupa Topex Sp. z o.o." Sp.k. Limited Partnership. This catalogue is intended for informational purposes only and is not a binding offer for agreement. Pictures in the catalogue are for illustration purposes, real products may slightly vary from provided illustrations. Publication protected under copyright law. Copying, reprinting and distribution of the entirety or parts thereof, inclusive of on magnetic and electronic media, without the consent of Grupa Topex shall be prohibited.

Grupa Topex не несе відповідальності за можливі помилки в каталогах, брошурах та інших друкованих матеріалах. Grupa Topex залишає за собою право вносити зміни в продукцію без попереднього повідомлення. Це стосується і вже замовленої продукції. Заміна може бути здійснена без внесення будь-яких змін до вже узгоджених специфікацій. Усі торгові марки в цьому матеріалі є власністю відповідних компаній. Торгові марки GRAPHITE, VERTO, NEO, Top Tools є власністю компанії "Grupa Topex Sp. z o.o." Sp.k. Цей каталог носить виключно інформаційний характер і не є пропозицією укласти договір. Фотографії в каталозі наведені лише для ознайомлення, і продукція в реальності може дещо відрізнятися від зображеної на ілюстраціях. Публікація захищена авторським правом. Копіювання, передрук і розповсюдження повністю або фрагментів, у тому числі на магнітних або електронних носіях, без згоди Grupa Topex заборонено.

NEO  
TOOLS

TOPEX

VERTO

TOP TOOLS



BAILDON

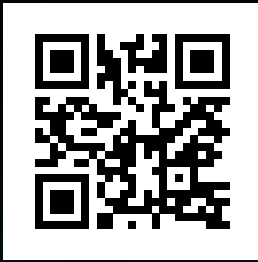

GRUPATOPEX.COM

