



2023

MOTO

NEO
TOOLS

GRAPHITE

FORCE
OUT OF THIS
WORLD



SIŁA
NIE Z TEGO
ŚWIATA

1000Nm

OŚWIETLENIE / WORKSHOP LIGHTING / ОСВІТЛЕННЯ



166-173

NORMALIA WARSZTATOWE / WORKSHOP STANDARD ITEMS / СТАНДАРТНІ ПРЕДМЕТИ МАЙСТЕРНІ



175-179

CHEMIA MOTORYZACYJNA / AUTOMOTIVE CHEMICALS / АВТОМОБІЛЬНА ХІМІЯ



181

BHP / OHS / ОХОРОНА ПРАЦІ



183-203

ELEKTRONARZĘDZIA I AKCESORIA / POWER TOOLS AND ACCESSORIES / ЕЛЕКТРОІНСТРУМЕНТИ ТА АКЦЕСУАРИ



207-229

AKCESORIA I GADŻETY MOTORYZACYJNE / AUTOMOTIVE ACCESSORIES AND GADGETS / АВТОМОБІЛЬНІ АКЦЕСУАРИ ТА ГАДЖЕТИ



231-233





NEO
TOOLS

NEO to...

Wysokiej klasy narzędzia dla profesjonalistów i wymagających użytkowników

NEO is...

Top class tools for professionals and demanding users

NEO це...

Високоякісні інструменти для професіоналів і вимогливих користувачів



Zapraszamy na kanały marki NEO w mediach społecznościowych

Come and browse NEO social media channels

Запрошуємо на канали марки NEO у соціальних мережах



@NEOTOOLS



@NEOTOOLSOFFICIAL



YouTube
VIDEO CONTENT

NEOmov



Informacje o nowościach produktowych, wydarzeniach, konkursy, porady oraz video

Information about novelities, events, competitions, tips and videos

Інформація про нові продукти, події, конкурси, поради та відео

VIDEO produktowe, porównania i testy produktów w wielu wersjach językowych

Product related VIDEOS, product comparisons and tests in multiple language versions

ВІДЕО про продукти, порівняння та тести продуктів у різних мовних версіях



JAKOŚĆ

Najwyższa jakość materiałów i najnowocześniejsze rozwiązania technologiczne to kluczowe założenia standardów jakości NEO. Narzędzia NEO to ergonomiczne, precyzyjnie wykonane narzędzia stworzone do pracy w najcięższych warunkach. Produkty NEO testowane są zarówno w specjalistycznych laboratoriach jak i w miejscach pracy profesjonalistów.

QUALITY

High quality of materials and well proven technical solutions are the key foundations of the NEO quality standards. High quality and precision of workmanship make the NEO tools fit for use in the harshest conditions. NEO products are tested in specialised laboratories as well as in professionals' workplaces.

КАЧЕСТВО

Высокое качество материалов и проверенные технические решения являются ключевыми принципами стандартов качества NEO. Благодаря высокому качеству и точности исполнения инструменты NEO отлично проявляют себя в сложнейших рабочих условиях. Продукты NEO тестируются как в специализированных лабораториях, так и на местах работы профессионалов.

Laboratorium NEO Tools

Narzędzia NEO poddawane są specjalistycznym i rygorystycznym testom wytrzymałościowym. Badania jakościowe oparte są o normy europejskie. System zarządzania jakością w Dziale Technicznym posiada certyfikat zgodności z jedną z najważniejszych norm dotyczących kontroli jakości ISO 9001:2015

NEO Tools laboratory

NEO tools undergo specialised and rigorous strength testing. Quality testing is based on European standards. The quality management system of the Technical Department is certified for compliance with one of the most important standards in the quality control field: ISO 9001:2015.

Лаборатория NEO Tools

Инструменты NEO подвергаются строгому специализированному тестированию на прочность. Проверка качества выполняется согласно европейским нормам. Система управления качеством в техническом отделе имеет сертификат соответствия одной из важнейших норм, касающихся контроля качества ISO 9001:2015





*

W procesie produkcji wykorzystywane są starannie wyselekcjonowane materiały, a jakość narzędzi jest stale weryfikowana w trakcie rygorystycznych procedur kontrolnych. Produkty NEO spełniają najwyższe kryteria jakościowe, czego znakiem jest 25-letni okres ochrony gwarancyjnej na narzędzia mechaniczne NEO.

Manufacturing process uses carefully selected materials, and the tool quality is constantly verified with rigorous control procedures. NEO products meet the highest quality criteria, which is confirmed with 25 years warranty for NEO mechanical tools.

В процессе производства используются старательно отобранные материалы, а качество инструментов постоянно верифицируется в ходе строгих контрольных процедур. Продукты NEO отвечают наивысшим критериям качества, что подтверждает 25-летняя гарантия на механические инструменты NEO.



Narzędzia NEO cieszą się zaufaniem wymagających użytkowników oraz profesjonalistów, którzy poszukują rozwiązań na najwyższym poziomie. O niezawodności i uznaniu ze strony środowiska biznesowego świadczą liczne wyróżnienia. Najważniejszym z nich jest międzynarodowy certyfikat TÜV, który jest jednym z najbardziej rozpoznawalnych znaków jakości na świecie.

NEO tools earned trust of demanding users and professionals who search for solutions of the highest standards. Reliability and recognition in the business sector are confirmed with numerous prizes and distinctions. The most important of all is the international TÜV certificate, one of the most recognised quality marks in the world.

Инструменты NEO пользуются доверием требовательных пользователей и профессионалов, ищущих решений на наивысшем уровне. О надежности и признании со стороны профессионального сообщества свидетельствуют многочисленные знаки отличия. Важнейший из них - международный сертификат TÜV, являющийся одним из наиболее узнаваемых знаков качества в мире.



* 25 lat Gwarancji oraz certyfikat TÜV M + T (Monitoring + Testing) posiadają wybrane produkty NEO – szczegóły na stronie neo-tools.com
 Selected NEO products feature a 25-year warranty and a TÜV M + T (Monitoring + Testing) certificate – you can find details at neo-tools.com
 Некоторые товары NEO имеют 25-летнюю гарантию и сертификат TÜV M + T (Monitoring + Testing) – подробная информация доступна на сайте neo-tools.com



TESTOWANIE NARZĘDZI

Narzędzia mechaniczne i warsztatowe marki NEO Tools są testowane nie tylko laboratoryjnie, ale przede wszystkim w realnych warunkach pracy. Nasze narzędzia zanim wejdą na rynek używane są w profesjonalnym warsztacie mechanicznym NEO Garage.

Dzięki temu możemy zaoferować Państwu najwyższej jakości produkty przeznaczone do pracy w branży motoryzacyjnej.

TOOL TESTING

NEO Tools brand mechanical and workshop tools are tested not only in the laboratory, but also in real working conditions. Before they enter the market, our tools are used in the professional mechanical workshop NEO Garage.

This allows us to offer you the highest quality products for automotive work.

ВІПРОБУВАННЯ ІНСТРУМЕНТУ

Механічний та слюсарний інструмент торгової марки NEO Tools тестується не тільки в лабораторії, але, перш за все, в реальних робочих умовах. Наші інструменти перед виходом на ринок проходять випробування в професійній механічній майстерні NEO Garage.

Завдяки цьому ми можемо запропонувати Вам продукцію найвищої якості для автомобільних робіт.

NEO GARAGE



neogarage.pl

NEO

GARAGE

GARAŻ GARAGE ГАРАЖ

NEO Garage oferuje rozbudowaną i dopasowaną do potrzeb użytkowników ofertę garażowania różnego typu pojazdów

NEO Garage offers an extensive and tailor-made offer for garaging various types of vehicles.

NEO Garage пропонує широку та індивідуальну пропозицію для зберігання різних типів транспортних засобів

neogarage.pl

**SALA KONFERENCYJNA
CONFERENCE ROOM
КОНФЕРЕНЦ-ЗАЛ**

Możliwość organizacji spotkań biznesowych w wyjątkowym otoczeniu.

Exceptional environment for business meetings.

Можливість організації ділових зустрічей в унікальній обстановці.

EVENTY EVENTS ПОДІЇ

Dysponujemy przestrzenią 1000-1500 m² do zagospodarowania na potrzeby eventowe

We have 1,000-1500 m² of space available for event use.

Маємо простір 1000-1500 м² для проведення заходів

**STANOWISKA SAMOBSŁUGOWE
SELF SERVICE STATIONS
СТАНЦІЇ САМООБСЛУГОВУВАННЯ**

Możliwość samodzielnej naprawy i konserwacji pojazdów. Udostępniamy niezbędne narzędzia oraz myjnie i stanowiska do auto-detaingu.

Possibility to repair and maintain vehicles yourself. We provide the necessary tools as well as a car wash and auto-detaingu stands.

Можливість самостійно ремонтувати та обслуговувати транспортні засоби. Ми надаємо необхідні інструменти, а також автомийки та стенди для автосервісу.



WYPOSAŻENIE WARSZTATU

workshop equipment обладнання майстерні

Szafka narzędziowa

Tool cabinet / Werkzeugschrank / Шкафчик для инструментов / Шкаф инструментальна / Műhelykocsi / Dulap pentru scule / Skříňka na nářadí / Skrinka na náradie / Omarica za orodje / Įrankių spintelė / Instrumentu skapis / Тööriistakapp / Шкафче за инструменти / Ormar za alate / Ormaric za alatke / Ντουλαπάκι για εργαλεία / Armario de almacenaje para herramientas / Carrello porta utensili / Estante p. Ferramentas / Rmoire à outils / Gereedschapskast

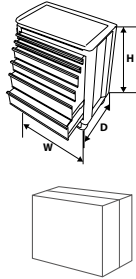

Ref.	D [mm]	W [mm]	H [mm]	capacity [kg]	☒	EAN
84-217	460	805	972	300	0/1	5907558482010

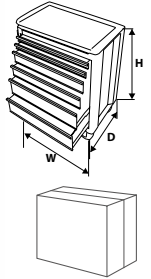

Ref.	D [mm]	W [mm]	H [mm]	capacity [kg]	☒	EAN
84-225	465	1105	978	600	0/1	5907558422269



Ref.	D [mm]	W [mm]	H [mm]	capacity [kg]	☒	EAN
84-223	480	780	750	200	0/1	5907558422276



Ref.	D [mm]	W [mm]	H [mm]	capacity [kg]	☒	EAN
84-220	460	810	980	300	0/1	5907558418293



Ref.	D [mm]	W [mm]	H [mm]	capacity [kg]	☒	EAN
84-221	460	680	1030	280	0/1	5907558422238



Ref.	D [mm]	W [mm]	H [mm]	capacity [kg]	☒	EAN
84-222	460	680	1030	280	0/1	5907558422245



Wózek warsztatowy

Workshop trolley / Werkstattrollwagen / Тележка для инструмента / Візок інструментальний / Műhely kocs / Cărucior de atelier / Dilenský vozík / Dielenský vozík / Delavniški voziček / Vežimėlis dirbtuvėms / Instrumentu ratiņi / Τρόχοκαράρι / Работна количка / Kolica za radionicu / Radionička kolica / Καρότσι εργαλείων / Carrito de taller / Carrello portautensili / Carrinho de oficina / Chariot d'atelier / Werkplaatskar

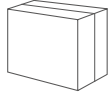

Компатыбне з вккладкамі нарэздыівымі NEO
Compatible with NEO tool inserts
Совместимость с инструментальными вставками NEO



Ref.	D [mm]	W [mm]	H [mm]	capacity [kg]	☒	EAN
84-229	390	630	810	130	0/1	5907558435610

75kg
capacity



Ref.	D [mm]	W [mm]	H [mm]	capacity [kg]	☒	EAN
84-404	420	660	835	75	0/1	5907558471625

Uchwyt na papier

Paper sheet holder / Papierhalter / Держатель для бумаги / Тримач для паперу / Papírtartó / Suport pentru hârtie / Držák na papír / Držiak na papier / Držalo za papir / Popieriaus laikiklis / Papiņa turētājs / Paberihoidik / Postavnica za hartija / Držač za papir / Držač za papir / Βάση χαρτιού / Portapapeles / Portacarta / Suporte de papel / Poignée pour papier



1mm
COLD
STEEL
ADAPTER
INCLUDED

for
84-221
84-222

Ref.	☒	EAN
84-271	0/10	5907558481617

Kosz na śmieci

Dust bin / Papierkorb / Корзина для мусора / Смітник / Szemetkosár / Coș de gunoi / Odpadkovú koš / Smetný kôš / Koš za smeti / Šiukšlių dėžė / Atkritumu grozs / Prügikorv / Кош за отпадцы / Košarica za smeće / Kanta za smeće / Καλάθι απορριβίων / Cubo de basura / Cestino della spazzatura / Caixaote de lixo / Poubelle



1mm
COLD
STEEL

5.5L

250x
68x
250mm



Ref.	☒	EAN
84-274	0/4	5907558481624

Szafka serwisowa 4 szuflady (nadstawka)

Service cabinet 4 drawers (extension) / Serviceschrank 4 Schubladen (Erweiterung) / Шкаф для обслуживания 4 ящиков (верхний блок) / Службова шафа 4 висувних ящиків / Szervizszekrény 4 fiókkal (felső egység) / Dulap de service 4 sertare (extensie) / Servisní skříňka 4 zásuvek (prodloužení) / Servisná skrinka 4 zásuviek (výsuv) / Servisna omara 4 predalov (podaljšek) / Aptarmavimo spinta 4 stalčiai (prailginimas) / Аркалрошанас skapis 4 atvilktnes (pagarinājums) / Teeninduskapp 4 sahtlit (pikendus) / Сервисен шкаф 4 чекмеджета (удължение) / Servisni ormar 4 ladica (produžetak) / Сервисни ормар 4 фиона (продужетак) / Σέρβις 4 σαρτάρια (επέκταση) / Armario de servicio 4 cajones (extensión) / Mobile di servizio 4 cassette (allunga) / Gabinete de serviço 4 gavetas (extensão) / Armoire de service 4 tiroirs (extension) / Servicekast 4 lades (uitbouw)



Ref.	D [mm]	W [mm]	H [mm]	☒	EAN
84-218	420	670	450	0/1	5907558484588

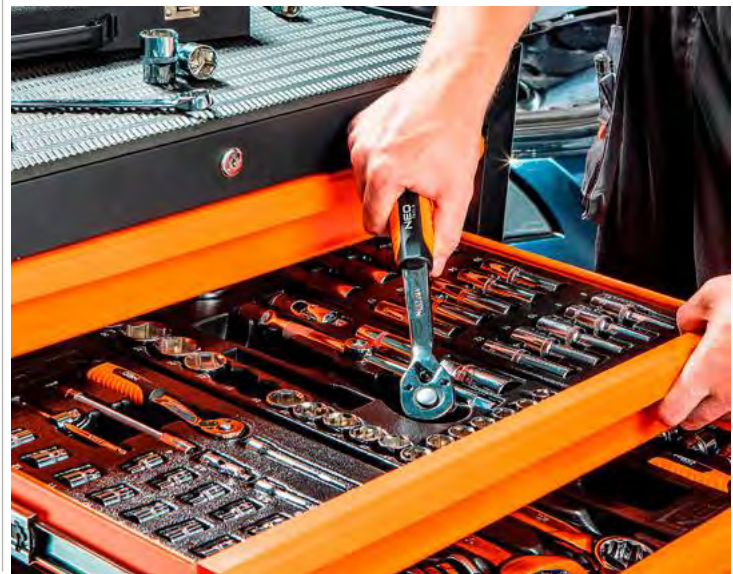

Haki

Hooks / Haken / Крючки / Гачи / Horgok / Cârlige / Háky / Skoby / Kljuka / Kabliai / Āķi / Haagid / Кукки / Kuke / Кукке / Γάντζοι / Ganchos / Ganci / Anzóis / Crochets / Haken

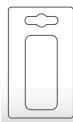

x3

40 mm

for
84-500
84-501



Ref.	L [mm]	⊠	EAN
84-096	40	0/65	5907558439267

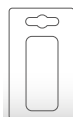

x5

85 mm

for
84-500
84-501



Ref.	L [mm]	⊠	EAN
84-097	85	0/50	5907558439274



x5

40 mm

for
84-500
84-501



Ref.	L [mm]	⊠	EAN
84-095	40	0/100	5907558439250



for
84-500
84-501



Ref.	⊠	EAN
84-092	8/40	5907558439151

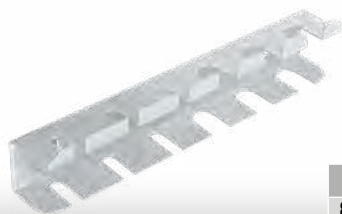
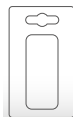

for
84-500
84-501

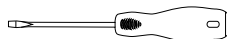

Ref.	⊠	EAN
84-093	0/100	5907558439168

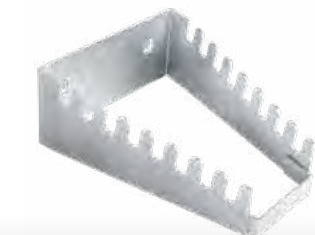
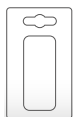

for
84-500
84-501



Ref.	⊠	EAN
84-094	0/50	5907558439175



for
84-500
84-501

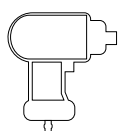

Ref.	⊠	EAN
84-098	0/100	5907558442526

System modułowy I

Modular system / Modulares System / Модульная система / Модульна система / Moduláris rendszer / Sistem modular / Modulární systém / Modulový systém / Modulární sistem / Moduline sistema / Modulu sistéma / Modulaarne süsteem / Модулна система / Modularni sustav / Модуларни систем / Αρθρωτό σύστημα / Sistema modular / Sistema modulare / Sistema modular / Système modulaire / Modulair systeem

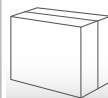

Ref.	L[mm]	W[mm]	H[mm]	⊠	EAN
84-259	745	510	1020	0/1	5907558431674



System modułowy I

Modular system / Modulares System / Модульная система / Модульна система / Moduláris rendszer / Sistem modular / Modulární systém / Modulový systém / Modularni sistem / Moduline sistema / Modulu sistēma / Modulaarne süsteem / Модулна система / Modularni sustav / Модуларни систем / Αρθρωτό σύστημα / Sistema modular / Sistema modulare / Sistema modular / Système modulaire / Modulair systeem



Ref.	L[mm]	W[mm]	H[mm]	☒	EAN
84-276	585	460	765	0/1	5907558443608



Ref.	L[mm]	W[mm]	H[mm]	☒	EAN
84-278	585	460	765	0/1	5907558443622



Ref.	L[mm]	W[mm]	H[mm]	☒	EAN
84-266	585	460	765	0/1	5907558433968



Ref.	L[mm]	W[mm]	H[mm]	☒	EAN
84-257	585	385	422	0/1	5907558431650



Ref.	L[mm]	W[mm]	H[mm]	☒	EAN
84-256	585	385	322	0/1	5907558431643



Ref.	L[mm]	W[mm]	H[mm]	☒	EAN
84-255	585	385	190	0/1	5907558431636



Ref.	L[mm]	W[mm]	H[mm]	☒	EAN
84-269	450	260	224	0/1	5907558443592



Ref.	L[mm]	W[mm]	H[mm]	☒	EAN
84-267	576	259	237	0/1	5907558433975



Ref.	L[mm]	W[mm]	H[mm]	☒	EAN
84-350	448	322	126	0/1	5907558459708



Ref.	L[mm]	W[mm]	H[mm]	☒	EAN
84-268	585	385	131	0/1	5907558443585



Ref.	L[mm]	W[mm]	H[mm]	☒	EAN
84-286	264	364	77	1/1	5907558446470



Ref.	L[mm]	W[mm]	H[mm]	☒	EAN
84-287	531	379	77	1/120	5907558446487



System modułowy II

Modular system / Modulares System / Модульная система / Модульна система / Moduláris rendszer / Sistem modular / Modulární systém / Modulový systém / Modularni sistem / Moduline sistema / Modulu sistēma / Modulaarne süsteem / Модулна система / Modularni sustav / Модуларни систем / Αρθρωτό σύστημα / Sistema modular / Sistema modulare / Sistema modular / Système modulaire / Modulair systeem



Ref.	L[mm]	W[mm]	H[mm]	☒	EAN
84-066	530	380	690	1/1	5907558450118



Ref.	L[mm]	W[mm]	H[mm]	☒	EAN
84-064	530	295	195	1/1	5907558450095



Ref.	L[mm]	W[mm]	H[mm]	☒	EAN
84-060	530	310	130	1/1	5907558450057



Ref.	L[mm]	W[mm]	H[mm]	☒	EAN
84-062	530	380	690	0/1	5907558450071



Ref.	L[mm]	W[mm]	H[mm]	☒	EAN
84-065	257	182	65	1/1	5907558450101

Adapter modułowy do systemu I & II

Modular adapter for I & II system / Modularer Adapter für I & II System / Модульный адаптер для системы I и II / Модульний адаптер для системи I & II / Moduláris adapter az I és II rendszerhez / Adaptor modular pentru sistemul I & II / Modulární adaptér pro systém I a II / Modulárny adaptér pre systém I a II / Modularni adapter za sistema I in II / I ir II sistemas modulunis adapteris / Modulārais adapteris I un II sistēmai / Модулен адаптер за система I и II / Αρθρωτός προσαρμογέας για το σύστημα I & II / Adaptador modular para el sistema I y II / Adattatore modulare per sistema I e II / Adaptador modular para sistemas I & II / Adapteur modulaire pour le système I & II / Modulaire adapter voor I & II systeem



Ref.	L[mm]	W[mm]	H[mm]	☒	EAN
84-061	530	310	225	1/1	5907558450064



Ref.	L[mm]	W[mm]	H[mm]	☒	EAN
84-281	600	345	74	0/1	5907558485233



Skrzynka narzędziowa

Tool box / Werkzeugkasten / Ящик для инструмента / Скриня інструментальна / Szerszámláda / Cutie scule / Nářadová skříňka / Basa na náradie / Škatla za orodje / Įrankių dėžė / Instrumentu koferis / Tööriistakast / Купар за инструменти / Kutija za alat / Kutija za alat / Εργαλειοθήκη / Caja de herramientas / Valigetta elettricista modulare / Caixa p. ferramentas / Caisse à outils / Gereedschapskist

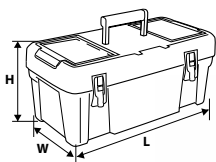

Ref.	L [mm]	W [mm]	H [mm]	☒	EAN
84-102	460	240	255	0/1	5907558409574
84-105	545	280	270	0/1	5907558408683

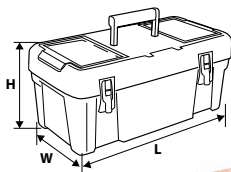

Ref.	L [mm]	W [mm]	H [mm]	☒	EAN
84-114	495	360	710	0/1	5907558439182

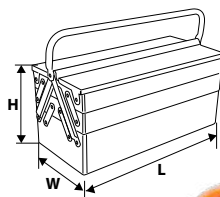

25 years
GUARANTEE



STEEL

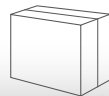

Ref.	L [mm]	W [mm]	H [mm]	m [kg]	☒	EAN
84-100	460	220	210	4,3	1/1	5907558409437
84-101	550	220	210	5	1/1	5907558409444

Skrzynka narzędziowa na kołach

Tool box with wheels / Werkzeugkasten / Ящик для инструмента с колесами / Скриня інструментальна / Szerszámkocsi / Cutie scule / Nářadová skříňka / Basa na náradie / Škatla za orodje / Įrankių dėžė / Instrumentu koferis / Tööriistakast / Купар за инструменти / Kutija za alat / Kutija za alat / Εργαλειοθήκη / Caja de herramientas / Carrello porta utensili / Caixa p. ferramentas / Caisse à outils / Gereedschapskist

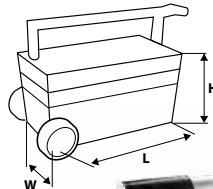

Ref.	L [mm]	W [mm]	H [mm]	☒	EAN
84-116	680	400	355	0/1	5907558421699

Warsztat mobilny

Mobile workshop / Werkzeugkasten / Мобильная мастерская / Скриня інструментальна / Szerszámkocsi / Cutie scule / Nářadová skříňka / Basa na náradie / Škatla za orodje / Įrankių dėžė / Instrumentu koferis / Tööriistakast / Купар за инструменти / Kutija za alat / Kutija za alat / Εργαλειοθήκη / Caja de herramientas / Carrello porta utensili / Caixa p. ferramentas / Caisse à outils / Gereedschapskist

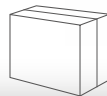
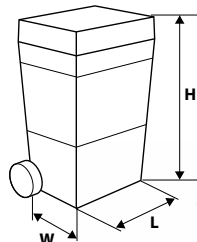

Ref.	L [mm]	W [mm]	H [mm]	☒	EAN
84-115	495	360	710	0/1	5907558421682



Organizer

Organizer / Organizer / Организатор / Организатор / Szortimenter / Organizer / Organizer / Organizér plast. na spoj. materiál / Škatla za orodje / Systeineris / Šikunkaste / Šáilituskast / Организатор / Kutija za alat / Kutija za alat / Organizer / Organizador / Organiser / Agenda / Organiseur / Organizer



12 wymiowych pojemników
12 removable containers
12 съёмные контейнеры



Antywstrząsowe narożniki
Anti-shake corners
Антивибрационные углы



Poliwęglanowa pokrywa
Polycarbonate cover
Поликарбонатная крышка



Aluminiowe zapięcie
Aluminum clasp
Алюминиевая застежка



Ref.	info	☒	EAN
84-130	40 x 40 x 12 cm	0/1	5907558431216



8 wymiowych pojemników
8 removable containers
8 съёмные контейнеры



Antywstrząsowe narożniki
Anti-shake corners
Антивибрационные углы



Poliwęglanowa pokrywa
Polycarbonate cover
Поликарбонатная крышка



Aluminiowe zapięcie
Aluminum clasp
Алюминиевая застежка



Regulowane przegrody
Adjustable dividers
Регулируемые отсеки



Ref.	info	☒	EAN
84-131	39 x 60 x 11 cm	0/1	5907558431223

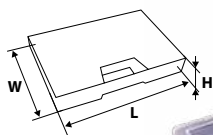

Ref.	L [mm]	W [mm]	H [mm]	☒	EAN
84-118	390	290	65	0/1	5907558439229
84-119	490	390	65	0/1	5907558439236

Plecak monterski

Tool backpack / Monteurrucksack / Рюкзак монтерский / Рюкзак монтерський / Szerszámos hátizsák / Rucsac pentru mecanic / Batoh na nářadí / Plecniak na nářadie / Nahrbtnik za orodje / Montuotojo įrankių kuprinė / Instrumentu mugursoma / Tööriistade seljakott / Монтерска раница / Rusak za montere / Monterski ranac / Σάκος εργαλείων / Mochila de montador / Zaino porta utensili / Mochila para ferramentas / Sac à dos porte-outils / Monteur ruzgak



Ref.	☒	EAN
84-304	0/6	5907558425833

Plecak monterski na kołach

Tool backpack with wheels / Monteurrucksack mit Rädern / Рюкзак монтерский на колесах / Рюкзак монтерський на колісцях / Szerszámos hátizsák / Rucsac pe roți pentru mecanic / Batoh na nářadí na kolečkách / Plecniak na nářadie na kolieskach / Nahrbtnik za orodje na kolesih / Montuotojo įrankių kuprinė su ratukais / Instrumentu mugursoma uz riteņiem / Tööriistade seljakott, ratastege / Монтерска раница на колела / Rusak za montere s kotačima / Monterski ranac sa točkicama / Σάκος εργαλείων με ρόδες / Mochila de montador sobre ruedas / Trolley/zaino in tela / Mochila para ferramentas com rodas / Sac à dos porte-outils à roulettes / Monteur ruzgak op wielen



Ref.	☒	EAN
84-303	0/2	5907558425826



Torba monterska

Tool bag / Monteurtasche / Сумка монтерская / Торба інструментальна / Szerszámtáska csőalakú fém fogantyúval / Geanta scule / Montérská brašna / Taška montérska kožená / Torba za orodje / Monterio krepšys / Instrumentu soma / Τσούριστκόττ / Купфар за инструменти / Torba za alat / Torba za alat / Σάκος για εργαλεία / Bolsa para herramientas / Borsa per meccanica / Sacco p. montaggio / Sac de monteur / Montagetas



Ref.	☒	EAN
84-301	0/2	5907558425802



Ref.	☒	EAN
84-308	0/4	5907558427745



Ref.	☒	EAN
84-300	0/4	5907558417258



Ref.	☒	EAN
84-305	0/6	5907558417265



Ref.	☒	EAN
84-315	0/35	5907558428391



Torba monterska na kołach

Tool bag with wheels / Monteurtasche / Монтерская сумка на колесах / Торба монтерська на коліщатах / Szerszámáska / Geantă pe roți pentru mecanic. / Taška na nářadí na kolečkách / Taška na náradie na kolieskach / Torba za orodje na kolesih / Montuotojo krepšys su ratukais / Instrumentu soma uz riteņiem / Tööriistakott, ratastega / Монтьорска торба на колела / Torba za montere s kotačima / Monterska torba sa točkicama / Τάσθα εργαλείων με ρόδες / Bolsa de montador sobre ruedas / Trolley in tela / Bolsa para ferramentas com rodas / Sac porte-outils à roulettes / Monteurstas op wielen



Ref.	☒	EAN
84-302	0/2	5907558425819



POLYESTER
600D

Pas monterski

Plicer belt / Monteuriemen / Пояс монтерский / Pas для инструмента / Szerszámóvtáska övvel / Bandă azeviză / Montérský pás / Opasok na náradie / Pas za orodje / Monterio diržas / Instrumentu josta / Liimimispressi lint / Колан за инструменти / Pojas za alat / Pojas torbica / Ζώνη μονταρίσματος / Cinturón para herramientas reforzado / Cintura porta utensili / Cinto p. montagem / Ceinture de monteur / Montageriem



PVC
1680D

400
g/m²

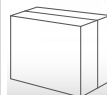

Ref.	☒	EAN
84-330	0/5	5907558415667

Uchwyt na młotek

Hammer holder / Aufnahme für Hammer / Зажим для молотка / Тримач до молотка / Kalapács tartó / Suport pentru ciocan / Držák na kladívko / Urínadlo kladiva / Vreetje za kladivo / Plaktuko rankena / Āmura ietvere / Vasarahoidik / Дръжка на чук / Drška za čekić / Hvat za čekić / Προσαρμογέας σφυριού / Sujeción para martillo / Gancio per martello / Manche de martelet / Houder voor hamer



PVC
1680D

400
g/m²

Ref.	☒	EAN
84-332	50/100	5907558415681

Stolek z torbą monterską

Chair with tool bag / Sitz mit Monteurtasche / Табурет складной с монтерской сумкой / Столик із монтерською торбою / Szerszámáska székhüvícióval / Scăunuş cu geantă pentru mecanic / Skládací židle s taškou na nářadí / Stólik s taškou na náradie / Mizica s torbo za orodje / Staliukas su montuotojo krepšiu / Taburete ar instrumentu somu / Tööriistakotiga laud / Табуретка с монтьорска торба / Stolica s torbom za montere / Stolica sa monterskom torbom / Πτυσσόμενο σκαμνίκι με τάσθα εργαλείων / Silla con bolsa de montador / Seggiolino pieghevole con borsa / Banco com bolsa para ferramentas / Sac à outils avec siège pliant / Kruk met monteurstas



Ref.	☒	EAN
84-306	0/10	5907558425796



POLYESTER
600D

Pas do kabur

Plicer belt / Monteuriemen / Пояс монтерский / Pas для инструмента / Őv szerszámátáskákhoz / Bandă azeviză / Montérský pás / Opasok na náradie / Pas za orodje / Monterio diržas / Instrumentu josta / Liimimispressi lint / Колан за инструменти / Pojas za alat / Pojas torbica / Ζώνη μονταρίσματος / Cinturón para herramientas reforzado / Cintura / Cinto p. montagem / Ceinture de monteur / Montageriem



PVC
1680D

400
g/m²



Ref.	☒	EAN
84-335	50/100	5907558421941

Saszetka

Waist bag / Gürteltasche / Поясная сумка / Торба на паску / Övtáska / Borseta / Ledvinka / Ladvinka / Pasma torbica / Déklas / Jostas soma / Vöökott / Паласка / Pasma torbica / Torbica / Τασθάκι μέσης / Riñonera / Marsupio porta utensili / Bolsa / Sacoche porte-outils à ceinture



Ref.	☒	EAN
84-311	0/70	5907558428377

Materiałowe etui na narzędzia

Textile tool case / Werkzeugkoffer aus Stoff / Тканевые чехлы для инструментов / Тканинні чохла для інструментів / Textil szerszámártartó / Husă textilă pentru scule / Materiálové pouzdro na nářadí / Materiálové pouzdro na náradie / Etui iz blaga za orodje / Medžiaginis įrankių dėklas / Auduma apvalki instrumentiem / Kangast tööriistavutlar / Платнен калъф за инструменти / Etui za alat / Kutije za alat / Υφασμάτινη θήκη εργαλείων / Estuche textil para las herramientas / Valigetta per utensili in tessuto / Estojo têxtil para as ferramentas / Trousse rangement des outils en tissu / Stoffen gereedschapsetui



22
POUCHES

UNIVERSAL



Ref.	☒	EAN
09-890	0/40	5907558458923



Kieszonka na narzędzia

Tool pocket / Werkzeugtasche / Сумка для инструментов / Карман для инструмента / Szög és szerszámtartó / Buzunar pentru scule / Kapsa na nářadí / Vrecko na náradie / Žep za orodja / Deklas įrankiams / Instrumentu somiņa / Тööriistatasku / Презградка за инструменти / Futrola za alate / Džep za alat / Τοάβα εργαλείων / Portaherramientas / Marsupio porta utensili / Bolso p. ferramentas / Poche à outils / Gereedschapszak

x4
PVC 1680D
400 g/m²

Ref.	☒	EAN
84-333	0/50	5907558415698

x8
PVC 1680D
400 g/m²

Ref.	☒	EAN
84-334	20/40	5907558415704

Perforacja narzędziowa

Tool wall / Werkzeuglochung / Панель перфорированная для инструментов / Панель инструментальная / Szerszámosfal / Suport perete pentru unelte / Perforace pro uchycení držáků nářadí / Panel na náradie / Stenski regal / Sienelė įrankiams / Instrumentu plaukts / Тööriistalaus / Перфорация на инструменти / Perforirani organizer za alate / Polica za alat / Τοίχος για εργαλεία / Tablero organizador para herramientas / Perforazione per attrezzi / Perfuração de ferramentas / Plaques perforées pour outils / Gereedschapswand

60 cm
60 cm
± 2 cm
steel thickness 0.8 mm
steel cold SPCC
includes WALL PLUGS

Ref.	H [mm]	W [mm]	D [mm]	☒	EAN
84-500	600	600	20	0/1	5907558454253

120 cm
60 cm
± 2 cm
steel thickness 0.8 mm
steel cold SPCC
includes WALL PLUGS

Ref.	H [mm]	W [mm]	D [mm]	☒	EAN
84-501	600	1200	20	0/1	5907558454260

Hak na pojemnik

Hooks / Hacken / Крючки / Гаки / Horgok / Cârłige / Háky / Skoby / Kljuka / Kabliai / Āķi / Haagid / Кукы / Kuke / Kuke / Тάγτσοι / Ganchos / Ganci / Anzóis / Crochets / Haken

steel cold SPCC
steel thickness 1.0 mm
10x6 cm

Ref.	☒	EAN
84-502	250/250	5907558454277

steel cold SPCC
steel thickness 1.0 mm
13x6.5 cm

Ref.	☒	EAN
84-503	250/250	5907558454284

Listwy magnetyczne

Magnetic tool holders / Magnetische Werkzeughalter / Держатели магнитных инструментов / Магнітні тримачі інструментів / Mágneses szerszámtartók / Suporturi de scule magnetice / Magnetické držáky nástrojů / Magnetické držáky nástrojov / Magneta držala za orodje / Magnetinių įrankių laikikliai / Magnētisko instrumentu turētāji / Magnetiliste tööriistade hoidjad / Магнітні държачи за инструменти / Magnetski držači alata / Magneti držači alata / Μαγνητικά εργαλεία στήριξης / Portaherramientas magnéticas / Portautensilii magnetici / Porta-ferramentas magnéticas / Porte-outils magnétiques / Magnetische gereedschapshouders

x3

Ref.	☒	EAN
84-144	6/12	5907558449006



Haki

Hooks / Hacken / Ξρῶκι / Ганги / Horgok / Cârlițe / Háky / Skoby / Kljuko / Kabliai / Άγκι / Haagid / Куки / Kuke / Kuke / Γάντζοι / Ganchos / Ganci / Anzóis / Crochets / Haken

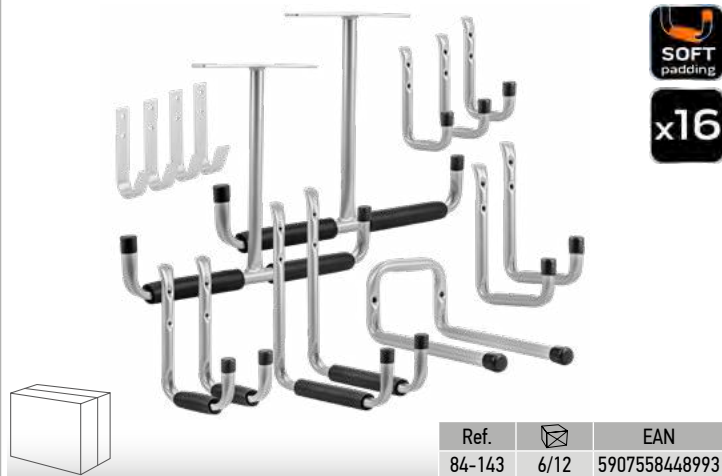
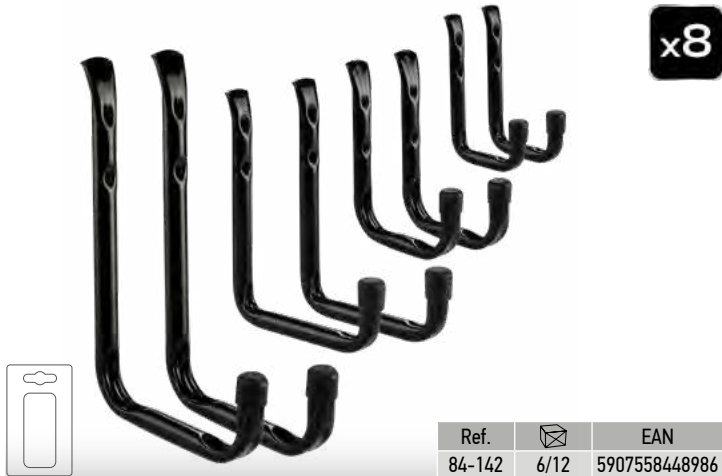

Wózek transportowy

Multipurpose trolley / Transportwagen / Тележка грузовая / Візок транспортувальний / Molnárkocsi / Cărucior de transport / Převravný vozík / Prepravňý vozík / Transportni voziček / Maišelis transportavimui / Ratiņi / Veokāru / Транспортна нолчца / Transportna kolica / Transportna kolica / Καρότσια μεταφοράς / Carretilla de transporte / Carrello di trasporto / Carrinho de transporte / Chariot de manutention / Transportwagen



Platforma transportowa

Transport platform / Транспортная платформа / Plataforma de transport / Anyagmozgató kocsi / транспортна платформа / Dopravná plošina / Transportní plošina / Transportplattform / Transportna platforma / Transporto platforma / Transporta platforma / Transportdiplavorm / Транспортна платформа / Transportna platforma / Транспортна платформа / Платформа μεταφοράς / Plataforma de transporte / Piattaforma di trasporto / Plataforma de transporte / Plateforme de transport / Transportplattform

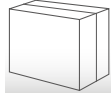

Ref.	capacity [kg]	☒	EAN
84-141	200	0/6	5907558448979

Najezd samochodowy

Car ramp / Autorampe / Автомобильная рама / Автомобильна рама / Autó rámpa / Rampa auto / Nájezd na auto / Nájezd na auto / Avtorampa / Automobilij rampa / Auto rampa / Auto kaldtee / Рампа за кола / Rampa za auto / Ауто рампа / Ράμπα αυτοκινήτου / Rampa de coche / Rampa per auto / Rampa de carro / Rampe de voiture / Auto oprijplaat



910x 310x 170 mm	3000kg
2pcs	PP

Ref.	[t]	☒	EAN
10-478	3	1/1	5907558495874

Podnośnik warsztatowy

Shop crane / Werkstattheber / Внутримачеховий кран / Кран гаражний / Műhelydarú, motorkiemelő zsráf / Cric de atelier / Dielenský zvlňák / Dvigalka / Keltuvus dirbtuvėms / Profesionālais pacēlājs / Töökõjatungraud / Ποδηγιστ / Radionička dizalica / Radionička dizalica / Γερανός για γκαράζ / Gato de taller / Gruetta / Elevador de oficina / Vérin d'atelier / Werkplaats hijstoestel

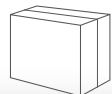
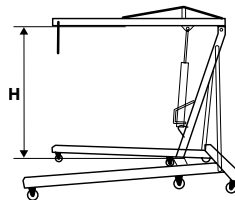

Ref.	[t]	H [mm]	☒	EAN
11-720	2	25-2382	0/1	5907558419665

Taśma do bagażu

Luggage strap / Gepäckband / Лента для багажа / Стрічка багажна / Rakományrögző / Bandă de bagaje / Popruh na zavazadla / Pás na náklady / Trak za prtljago / Krovinij tvrtinimo juosta / Bagāžas lente / Koortarihmad / Лента за багаж / Traka za prtljagu / Traka za prtljag / Ταβία αποσκευών / Cinta para maleta / Cinghie con cricchetto / Fita p. Bagagem / Bande à bagage / Bagageband

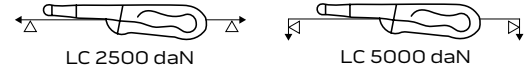

Ref.	KG	L [m]	W [mm]	☒	EAN
84-140	2500 / 5000	5	50	0/10	5907558448962

Wciągarka łańcuchowa

Chain block / Kettenwinde / Лебедка цепная / Тяль ланцюгова / Láncos emelő / Troliu cu lant / Řetězový kladkostroj / Řetězový zdvihák / Verižna dvigalka / Grandininé gervé / Kēdes vinča / Kettvints / Верижна лебедка / Lančani podizač / Lančana dizalica / Βαρούλλο με αλυσίδα / Cabria de cadena / Paranco a catena / Guincho de corrente / Treuil à chaîne / Kettingtakel

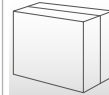

Ref.	[t]	L [m]	☒	EAN
11-760	1	3	0/1	5907558418385
11-761	2	3	0/1	5907558418392
11-762	3	3	0/1	5907558418408
11-763	5	3	0/1	5907558418415

Podstawki pod samochód

Jack stands / Kfz-Unterlagen / Підставки автомобільніе / Підставка під автомобіль / Emelő bak / Suport de ridicare / Podpěra panenka / Podpera panenka / Podstavki za hidravlično dvigalko / Automobilišnis domkratas / Paliktnis zem auto / Tungrauva alused / Стойка за кола / Držač za auto dizalicu / Drzac za auto dizalicu / Γρύλος σταθερός / Soporte para coche / Cavalletti di sollevamento / Suporte para carro / Supports pour voiture / Autosteunen

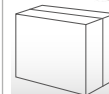

Ref.	[t]	H [mm]	☒	EAN
11-750	3	295 - 415	1/1	5907558418361
11-751	2	278 - 423	1/1	5907558418378



Podnośnik przesuwny

Floor jack / Schiebeheber / Домкрат подкатной / Домкрат / Aluminium hidraulikus krokodilemelő / Cric de podea / Přenosný zvedák / Zdvihák hydraulický vozík / Hidraulická dvigalka / Domkratas / Pacelājs / Tungraud / Крук / Hidraulična auto dizalica / Hidraulicna auto dizalica / Γρύλος τρόλλει / Gato hidráulico / Sollevatore a carrello / Elevador de deslize / Cric mobile / Schuifrijshoestel

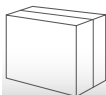

Ref.	[t]	☒	EAN
11-730	1.25	0/1	5907558416930

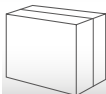
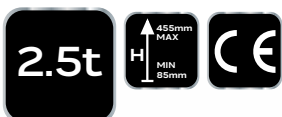

Ref.	[t]	☒	EAN
11-731	2.5	0/1	5907558416947

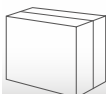
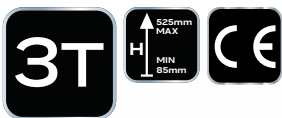

Ref.	[t]	☒	EAN
11-732	3.0	0/1	5907558436716

Podnośnik słupkowy

Bottle jack / Säulenhebergerät / Домкрат гидравлический бутылочный / Домкрат пляшкочов / Palackemelő / Cric coloană / Zvedák pístový / Stříkový zdvihák / Dvigalka / Hidraulinis keltuvas / Mastu pacelājs / Latt-tungraud / Колонен подемник / Stupna dizalica / Stubasta dizalica / Γρύλος υδραυλικός μπουκάλας / Gato hidráulico de botella / Sollevatore a bottiglia / Elevador com columnas / Cric bouteille / Paalhijstoestel

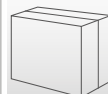

Ref.	[t]	H [mm]	☒	EAN
10-450	2	181 - 345	1/6	5907558470468
10-451	3	195 - 370	1/6	5907558470475
10-452	5	215 - 413	1/4	5907558470482
10-453	8	230 - 456	1/4	5907558470499
10-454	10	230 - 460	1/4	5907558470505
10-455	15	230 - 460	1/2	5907558470512
10-456	20	240 - 452	1/2	5907558470529



Leżanka warsztatowa

Car creeper / Werkstattliege / Лежанка рабочая / Візок на роликів для / Роботи під автомобілем / Szerelőágy, összecuskható / Sezlong de atelier / Dílenská lehátka / Montážne ležadlo / Delavniški ležalnik / Sulankstoma lova, dirbtuvėms / Darba gujamkrėsls / Veerevalus / Монтёрско килимче / Radionička ležaljka / Radionički kauč / Ξαπόστρα συνεργείου / Camilla de taller / Lettino sottomacchina / Carrinho de oficina / Werkplaatsbank



93x44x10.5
cm

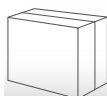
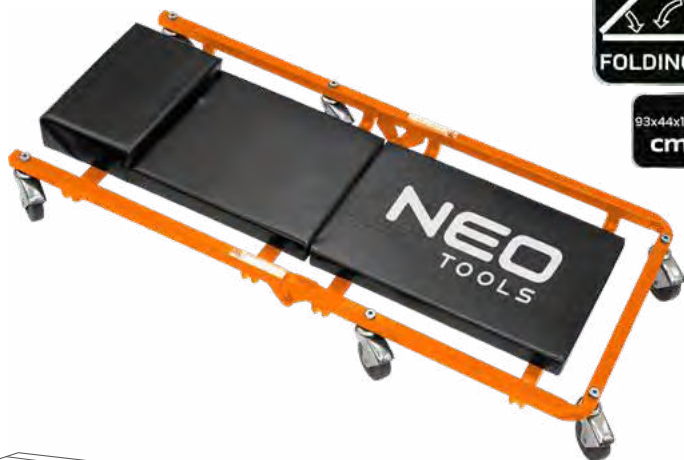

Ref.	m _{max} [kg]	☒	EAN
11-600	150	0/1	5907558418347



40x14x102
54.5x40.5x48
cm

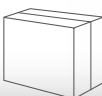

Ref.	m _{max} [kg]	☒	EAN
11-601-1	150	1/1	5907558445282

Stojak na silnik

Engin stand / Motorhalter / Стенд для ремонту двигателю / Стенд для ремонту двигуна / Motorszereelő állvány / Stativ pentru motor / Stojan na motor / Stojalo za motor / Variklio stovas / Dzinēja remonta stativs / Motoristend / Стойка за двигател / Stalak za motor / Stalak za motor / Βάση επισκευής κινητήρων / Soporte para motor / Cavalletto supporto motore / Suporte de motor / Support moteur / Motor onderstel



Ref.	☒	EAN
11-710	0/1	5907558436662

Podnošnik do skrzyń biegów

Transmission jack / Getriebeheber / Трансмісійна стойка / Стойка трансмісійна / Sebességváltó emelő / Cric pentru cutia de viteze / Zvedák převodovek / Zdvih prevodovky / Dvigalo za menjalnik / Pavarų dežės keltuvas / Átrunkárbus domkrats / Kägükasti tungraud / Трансмісійен подемник / Podizač tjenjača / Dizalica za menjač brzina / Σασημόθυρος / Elevador de caja de engranajes / Martinetto per scatole del cambio / Elevador da caixa de velocidades / Jack de transmission



min
0,9 m
max
1,9 m

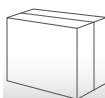

Ref.	☒	EAN
11-712	0/1	5907558436679

Belka do podnoszenia silnika

Engine beam hoist / Balken zum Anheben des Motors / Балка для підйому двигателю / Балка для підйому двигуна / Motoremelő gerenda / Bară pentru ridicarea motorului / Nosník pro zvedání motoru / Nosník na zavesenie motora / Dvigalka za avtomobilski motor / Variklio keltuvas / Sija motora parcelšanai / Mootori tõstmise tala / Γρεδα за повдигане на двигателю / Greda za podizanje motora / Greda za podizanje motora / Τραβέρσα ανύψωσης κινητήρων / Viga elevadora para el motor / Trave di sollevamento del motore / Viga elevadora do motor / Barre support moteur / Balk voor het heffen van de motor



730-1490
mm
WORKING
RANGE

0-205
mm
ADJUSTABLE
HEIGHT

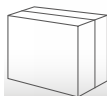

Ref.	☒	EAN
11-749	0/1	5907558459760



1750mm
MAX
H
MIN
885mm

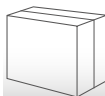

Ref.	☒	EAN
11-711	1/1	5907558445534



Stół warsztatowy

Work bench / Werkstattbank / Стол-верстак / Верстак / Állítható munkapad / Teigheia tímplárie / Dilenský stůl / Stolik pracovný / Delavniška miza / Darbastalis / Darba galds / Tööpink / Работна маса / Stol radionički / Radni sto / Πάγκος εργασίας / Banco de trabajo / Banco da lavoro / Mesa de oficina / Etabli d'atelier / Werkplaatstafel

1500x
780x830
mm

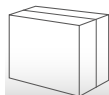

Ref.	[mm]	☒	EAN
11-716	1500 x 780 x 830 – 980 mm	0/1	5907558436693

Prasa hydrauliczna

Hydraulic press / Hydraulische Presse / Гидравлический пресс / Прес гидравлический / Hidraulikus prés / Presă hidraulică / Hydraulický lis / Hydraulický lis / Hidravlična stiskalnica / Hidraulinis presas / Hidrauliskā prese / Hidrauliline press / Хидравлична преса / Hidraulična preša / Hidraulična presa / Υδραυλική πρέσα / Prensa hidráulica / Pressa idraulica / Prensa hidráulica / Presse hydraulique

20T

0-905
mm

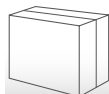

Ref.	☒	EAN
11-714	0/1	5907558436686

Mata serwisowa na błotniki, magnetyczna

Car body servis cover, magnetic / Servicematten für Kotflügel, magnetisch / Накладка магнитная на крыло / Накладки магнітні до брызговики / Mágneses sárvédő takaró / Rogajini servicii pentru aripi, magnetice / Ochranné přehozy na blatníky, magnetické / Servisné rohože pre blatníky, magnetické / Servisne obloge za blatnike, magnetne / Apsauginė magnetinė dangta ant sparno / Mašinas spārta magnētiskais paklājs instrumentiem / Porilaudade hooldusmatid, magnetilised / Магнитно покривало за каплицы / Servisne mate za blatobrane, magnetske / Servisne podloge za branike, magnetne / Μαγνητική ποδιά φτερού / Alfombras de servicio para guardabarros, magnéticas / Stuoie per manutenzione sui parafranghi, magnetiche / Coberturas magnéticas para para-lamas / Bâches de garde-boue magnétiques / Service matten voor spatlappen



120x100
cm



Ref.	☒	EAN
11-718	0/20	5907558436709

1000x630
mm



Ref.	☒	EAN
11-719	0/25	5907558459753

Pokrowiec ochronny, folia ECO 5w1

Protective cover, ECO foil 5in1 / Schutzhülle, ECO 5in1 Folie / Защитный чехол, фольга ECO 5in1 / Захисне покриття, фольга ECO 5e1 / Védőburkolat, ECO 5in1 fólia / Husa de protecție, folie ECO 5in1 / Ochranný kryt, fólie ECO 5v1 / Ochranný kryt, fólia ECO 5v1 / Zaščitna prevleka, folija ECO 5v1 / Apsauginis dangtelis, ECO 5in1 folija / Aizsargpārvalks, ECO 5in1 folija / Kaitsekate, ECO 5in1 foolium / Защитно покриття ЕКО фолію 5e1 / Zaštitna navlaka, ECO 5u1 folija / Защитни поклопац, ЕЦО 5у1 фоліја / Funda protectora, lámina ECO 5 en 1

5in1

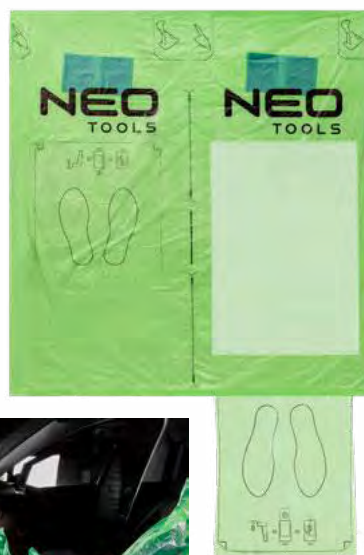

Ref.	☒	EAN
10-485		5907558495270



Odkurzacz warsztatowy

Workshop vacuum cleaner / Werkstattstaubsauger / Пылесос промышленный / Пилосос професійний / Parszívó / Aspirator atelier cu sistem vacuum / Dilenský vysávač / Dielenský vysávač / Industrijski sesalnik / Pramoninis siurblys / Rūpniecības puteklšūcējs / Tööstuslik tolmuieteja / Промышленна прахосмукачка / Radionički usisavač / Industrijski usisivač / Ηλεκτρική οκούλα επαγγελματική / Aspirador / Aspiratore umido secco / Aspirador de oficina / Aspirateur d'atelier / Werkplaatsstofzuiger

1500W
230V - 50Hz
18 kPa
max 2000 W
4 m
30 l
40 l

GRAPHITE
3 YEARS WARRANTY

Ref.	[kg]	⊠	EAN
59G607	10.0	0/1	5902062596079
59G608	12.3	0/1	5902062024350

Odkurzacz przemysłowy

Industrial vacuum cleaner / Industriestaubsauger / Пылесос промышленный / Пилосос промисловий / Ipari parszívó / Aspirator industrial / Průmyslový vysávač / Priemyselný vysávač / Industrijski sesalnik / Pramoninis dulkių siurblys / Rūpnieciskais puteklšūcējs / Tööstuslik imur / Промышленна прахосмукачка / Industrijski usisavač / Ηλεκτρική οκούλα / Aspirador industrial / Aspiratore industriale / Aspirador industrial / Aspirateur industriel / Industriële stofzuiger

1600W
230V - 50Hz
30 l
18 kPa
4 m
max 2000 W

GRAPHITE
3 YEARS WARRANTY

Ref.	[kg]	⊠	EAN
59G610	12,5	1/1	5902062085511

Agregat prądowórczy

Electric generator / Stromerzeugungsaggregat / Генератор бензиновый / Електрогенератор бензиновий / Áramfejlesztő / Grup electrogen/generator / Elektrický agregát / Prúdový agregát / Električni generator / Generatorius / Benzina elektrogenerators / Voolutootmiseade / Электрически агрегат / Agregat za struju / Naponski generator / Γεννήτρια βενζίνης / Grupo electrógeno / Gruppo elettrogeno / Gerador de eletricidade / Groupe électrogène / Elektrische generator

2000W / max 2200W
230V - 50Hz
12V
15 L

GRAPHITE
3 YEARS WARRANTY

Ref.	[kg]	⊠	EAN
58G904	36	1/1	5902062087928

2800W / max 3000W
230V - 50Hz
12V
15 L

3 YEARS WARRANTY
10 YEARS WARRANTY
AVR
4 STROKE ENGINE
COPPER WIRE
OVERLOAD PROTECTION

Ref.	[kg]	⊠	EAN
04-730	53 kg	1/1	5907558483680

6000W / max 6500W
230V - 50Hz
12V
25 L

3 YEARS WARRANTY
10 YEARS WARRANTY
AVR
4 STROKE ENGINE
COPPER WIRE
OVERLOAD PROTECTION

Ref.	[kg]	⊠	EAN
04-731	88.3 kg	1/1	5907558483697

7000W / max 7500W
400V - 50Hz
12V
25 L

3 YEARS WARRANTY
10 YEARS WARRANTY
AVR
4 STROKE ENGINE
COPPER WIRE
OVERLOAD PROTECTION

Ref.	[kg]	⊠	EAN
04-732	91 kg	1/1	5907558495997



Myjka wodna ciśnieniowa

High pressure cleaner / Wasserhochdruckreiniger / Моечная машина / Машина моечка / Magasnyomású mosó / Masina de spalat cu presiune / Vodní tlaková myčka / Tlaková vodná čistička / Visokotlačni čistilec / Aukšto slėgio plovimo įrenginys / Augstspiediena mazgājātā ierīce / Survepesur / Водоструйка под напоягане / Visokotlačni čistač / Čistač sa visokim pritiskom / Πλυτήριο / Limpiadora de presión / Idrapulitrice / Aparelho de lavar de pressão / Nettoyeur à eau haute pression / Hogedrukreiniger



1600W



230V- 50Hz

OUT:
90 bar
MAX 130 bar

6L/min
MAX 7L/min

GRAPHITE

3
YEARS
WARRANTY



2000W



230V- 50Hz

OUT:
110 bar
MAX 150 bar

6L/min
MAX 7.5L/min



GRAPHITE

3
YEARS
WARRANTY



2000W



230V- 50Hz

OUT:
100 bar
MAX 150 bar

6L/min
MAX 7.5L/min



3
YEARS
WARRANTY

10
YEARS
WARRANTY

AUTO
STOP
system

Ref.	[kg]	⊠	EAN
59G620	7,66	1/1	5902062086051

Ref.	[kg]	⊠	EAN
59G621	9,26	1/1	5902062086068

Ref.	[kg]	⊠	EAN
04-705	8,04	1/1	5907558469493

Wentylator

Fan / Fan / вентилятор / вентилатор / ventilátor / ventilator / větrák / vetrák / Ventilator / Ventilatorius / Ventilators / Ventilator / Вентилятор / Леназа / Ανεμιστήρας / Admirador / Fan / Fan / Ventilateur



Ref.	⊠	EAN
90-001	0/1	5907558442717

Ref.	⊠	EAN
90-002	0/1	5907558442724

Ref.	⊠	EAN
90-003	0/1	5907558442731

Ref.	⊠	EAN
90-004	0/1	5907558442731



Wentylator

Fan / Fan / вентилятор / вентилятор / ventilátor / ventilator / větrák / vetrák / Ventilator / Ventilatorius / Ventilators / Ventilator / Вентилятор / Ventilator / Πενεζα / Ανεμιστήρας / Admirador / Fan / Fan / Ventilateur



- 111W
- Ø 45 CM
- 3 AIRFLOW SPEEDS
- METAL BODY
- 360°
- COPPER MOTOR



Ref.	☒	EAN
90-007	0/1	5907558442779



- 100W
- Ø 50 CM
- 3 AIRFLOW SPEEDS
- 360°
- METAL BODY
- COPPER MOTOR
- HEAVY DUTY
- IP44



Ref.	☒	EAN
90-008	0/1	5907558442786

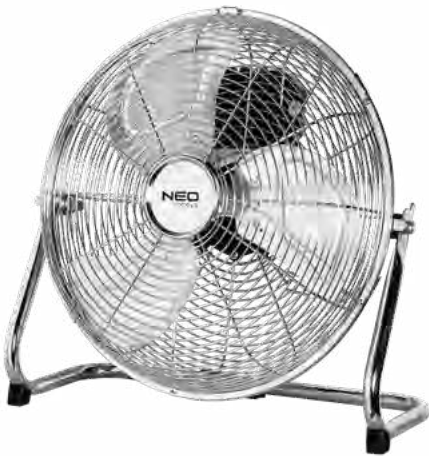

- 50W
- Ø 30 CM
- 3 AIRFLOW SPEEDS
- METAL BODY
- COPPER MOTOR



Ref.	☒	EAN
90-009	0/1	5907558466225



- 100W
- Ø 45 CM
- 3 AIRFLOW SPEEDS
- METAL BODY
- COPPER MOTOR



Ref.	☒	EAN
90-010	0/1	5907558466232



Promiennik

Infrared heater / Heizkörper / Радиатор / Radiator / Radiator / Radiator / Radiator / Infraraddeçi grelec / Infraradonujų spindulių šildytuvas / Infrasarkanais sildītājs / Infrapuna kütteseade / Инфрачервен нагревател / Инфраревни грејач / Υπερυβρη θερμάστρα / Calentador de infrarrojos / Riscaldatore a infrarossi / Infrarood verwarming / Chauffage infrarouge



18m² 6000h golden halogen lamp IP65

2kW

Ref.	⊠	EAN
90-030	0/6	5907558447415



18m² 6000h golden halogen lamp IP65

2kW

Ref.	⊠	EAN
90-031	0/6	5907558447422



2kW carbon infrared heating lamp 10 000h IP55 32m²

Ref.	⊠	EAN
90-039	0/4	5907558457902



2kW 24m² 6000h low glare amber lamp IP65

Ref.	⊠	EAN
90-032	0/4	5907558447439



1.5 kW halogen lamp 9m² 5000h IP44

Ref.	⊠	EAN
90-034	0/2	5907558447453



1,5 kW halogen lamp 5000h aluminium body IP44

Ref.	⊠	EAN
90-037	0/1	5907558457889



2kW halogen lamp 6000h aluminium body IP44

Ref.	⊠	EAN
90-038	0/1	5907558457896



1kW carbon fiber lamp 3m² AUTO OFF 6000h IP44

Ref.	⊠	EAN
90-035	0/4	5907558447460



Promiennik

Infrared heater / Heizkörper / Ραδιатор / Radiator / Radiator / Radiator / Radiator / Infrardeči grelec / Infraraudonųjų spindulių šildytuvai / Infrasarkanais sildītājs / Infraruna kütteseade / Инфракрасен нагревател / Infraroveni grijač / Инфрацрвени грејач / Υπέριθρη θερμάστρα / Calentador de infrarrojos / Riscaldatore a infrarossi / Infrarood verwarming / Chauffage infrarouge



2kW

6000h

halogen lamp

2,1m

aluminium body

IP34

Ref.	☒	EAN
90-036	0/1	5907558457872

Statyw

Tripod / Stativ / Штатив / Штатив / Háromlábú / Trepied / Stativ / Statív / Stojalo / Trikojis / Statīvs / Statiiv / Статив / Τρονοζας / Троножка / Trípode / Trípode / Treppiedi / Statief / Trépied



1,1-1,8 m

Ref.	☒	EAN
90-033	0/6	5907558447446

Nagrzewnica

Electric heater / Elektrische Heizung / Электрический нагреватель / Elektrichnii obіgrіvač / Hőszűrés / Incalzitor electric / Elektrický ohřivač / Elektrický ohrievač / Električni grelec / Elektrinis šildytuvai / Elektriskais sildītājs / Elektrikeris / Электрически нагревател / Električni grijač / Električni greјач / Ηλεκτρική θερμάστρα / Calentador eléctrico / Stufa elettrica / Elektrische verwarming / Chauffage électrique



PTC

AUTO STOP

Ref.	P [kW]	[m³/h]	☒	EAN
90-060	2	139	0/1	5907558447477
90-061	3	210	0/1	5907558447484



PTC



Ref.	P [kW]	[m³/h]	☒	EAN
90-062	2	197	0/8	5907558447491
90-063	3	280	0/1	5907558447507
90-064	5	588	0/1	5907558447514



STAINLESS STEEL HEATER

Ref.	P [kW]	[m³/h]	☒	EAN
90-065	2	253	0/1	5907558447521
90-066	3	291	0/1	5907558447538



STAINLESS STEEL HEATER



IPX4

Ref.	P [kW]	[m³/h]	☒	EAN
90-067	2	330	0/1	5907558447545
90-068	3	354	0/1	5907558447552
90-069	5	366	0/1	5907558447569



Nagrzewnica i wentylator

/ Electric heater and fan / Обогреватель и вентилятор / Fűtés és ventilátor / Нагрівач і вентилятор / Incalzitor si ventilator / Heizung und Lüfter / Ohrievač a ventilátor / Ohřivač a ventilátor Električni grelec / Elektrinis šildytuvas / Elektriskais sildītājs / Elektrikeris / Електрически нагревател / Električni grijač / Електрични грејач / Ηλεκτρική θερμάστρα / Calentador eléctrico / Stufa elettrica / Elektrische verwarming / Chauffage électrique

MANUAL



2400W
2 in 1

Ref.	P [kW]	[m³/h]	☒	EAN
90-070	2,4	460	0/4	5907558447576

DIGITAL



2400W
2 in 1

Ref.	P [kW]	[m³/h]	☒	EAN
90-071	2,4	460	0/4	5907558447583

Nagrzewnica olejowa

Oil heater / Ölheizung / Масляный нагреватель / Масляный нагревач / Olajmelegítő / Încalzitor cu ulei / Ohřivač oleje / Ohrievač oleja / Grelnik olja / Alyvos šildytuvas / Eļļas sildītājs / Ölikütteseade / Нагревател на масло / Grijač ulja / Грејач уља / Θερμαντήρας λαβίου / Riscaldatore dell'olio / Olie warmer / Réchauffeur d'huile

20 kW
DIESEL OIL / KEROSENE
550 m³/h
19l



Ref.	P [kW]	[m³/h]	☒	EAN
90-080	20	550	0/1	5907558457919

DIESEL OIL / KEROSENE



Ref.	P [kW]	[m³/h]	[l]	☒	EAN
90-081	30	750	34	0/1	5907558457926
90-082	50	1100	50	0/1	5907558457933

Nagrzewnica gazowa

Gas heater / Gasheizung / Газовый обогреватель / Газовий обігрівач / Gázmelegítő / Incalzitor pe gaz / Plynový ohřivač / Plynový ohrievač / Plinski grelec / Dujinski šildytuvas / Gāzes sildītājs / Gaaskütteseade / Газов нагревател / Plinski grijač / Гасни грејач / Θερμαντήρας αερίου / Calentador a gas / Stufa a gas / Gaskachel / Chauffage à gaz

GAS heater
PIEZO



Ref.	P [kW]	[m³/h]	[bar]	☒	EAN
90-083	15	580	0,7	0/1	5907558457940
90-084	30	1000	0,7	0/1	5907558457957
90-085	50	1000	1,5	0/1	5907558457964





NARZĘDZIA RĘCZNE MECHANICZNE

mechanical hand tools механічні ручні інструменти

Szafka narzędziowa

Tool cabinet / Werkzeugschrank / Шкафчик для инструментов / Шафа інструментальна / Műhelykocsi / Dulap pentru scule / Skříňka na nářadí / Skrinka na náradie / Omarica za orodje / Įrankių spintelė / Instrumentu skapis / Тööriistakapp / Шкафче за инструменти / Ormar za alate / Ormaric za alatke / Ντουλαπάκι για εργαλεία / Armario de almacenaje para herramientas / Carrello porta utensili / Estante p. Ferramentas / Rmoire à outils / Gereedschapskast

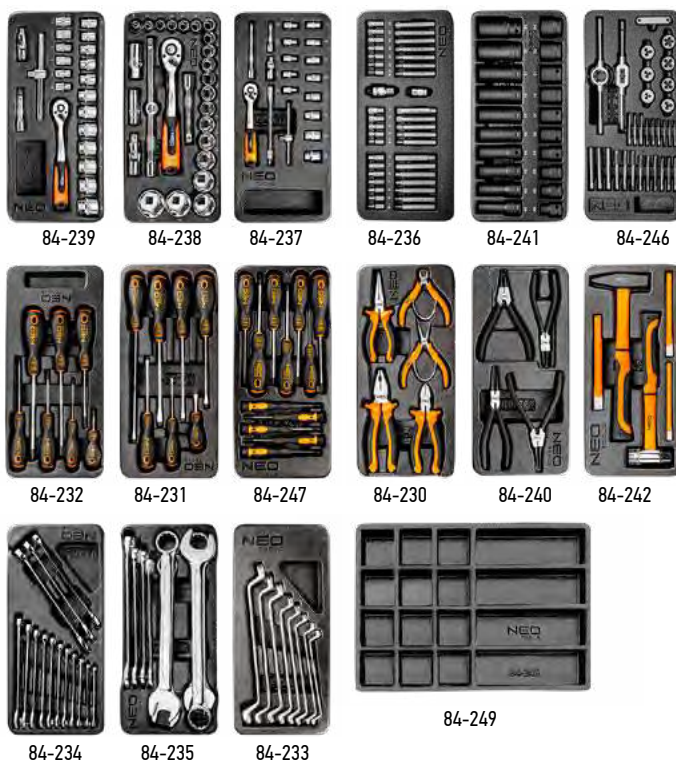
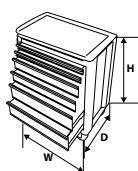

229 elements

Ref.	D [mm]	W [mm]	H [mm]	capacity [kg]	☒	EAN
84-225+G	465	1105	978	600	0/1	5907558487503

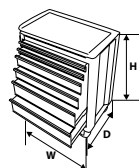

174 elements

Ref.	D [mm]	W [mm]	H [mm]	capacity [kg]	☒	EAN
84-220+G	465	775	978	300	0/1	5907558465020



Szafka narzędziowa

Tool cabinet / Werkzeugschrank / Шкафчик для инструментов / Шафа інструментальна / Műhelykocsi / Dulap pentru scule / Skříňka na nářadí / Skrinka na náradie / Omarrica za orodje / Įrankių spintelė / Instrumentu skapis / Тоолристаркарр / Шкафче за инструменти / Ormar za alate / Ormaric za alatke / Ντουλαπάκι για εργαλεία / Armario de almacenaje para herramientas / Carrello porta utensili / Estante p. Ferramentas / Rmoire à outils / Gereedschapskast

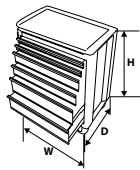

84-235 84-234 84-233 84-232 84-231 84-244



84-249



84-238 84-237 84-236 84-240 84-230 84-242

149 elements

Ref.	D [mm]	W [mm]	H [mm]	capacity [kg]	☐	EAN
84-217+G	460	805	972	300	0/1	5907558483062

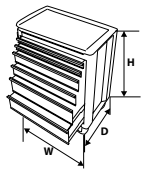

1 szuflada / drawer / ящик



84-236 84-230 84-240

2 szuflada / drawer / ящик



84-238 84-232 84-231

3 szuflada / drawer / ящик



84-243 84-234 84-235

4 szuflada / drawer / ящик



84-249

126 elements

Ref.	D [mm]	W [mm]	H [mm]	capacity [kg]	☐	EAN
84-223+G	480	780	750	200	0/1	5907558427097

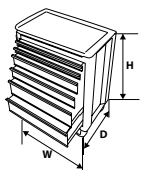

1 szuflada / drawer / ящик



84-237 84-239 84-238

2 szuflada / drawer / ящик



84-230 84-231 84-232

3 szuflada / drawer / ящик



84-233 84-234 84-236

4 szuflada / drawer / ящик



84-249

149 elements

Ref.	D [mm]	W [mm]	H [mm]	capacity [kg]	☐	EAN
84-221+G	460	680	1030	280	0/1	5907558425840



Szafka narzędziowa

Tool cabinet / Werkzeugschrank / Шкафчик для инструментов / Шафа інструментальна / Műhelykocsi / Dulap pentru scule / Skříňka na nářadí / Skrinka na náradie / Omarica za orodje / Įrankių spintelė / Instrumentu skapis / Тööriistakapp / Шкафче за инструменти / Ormar za alate / Ormarić za alatke / Ντουλαπάκι για εργαλεία / Armario de almacenaje para herramientas / Carrello porta utensili / Estante p. Ferramentas / Rmoire à outils / Gereedschapskast



129 elements

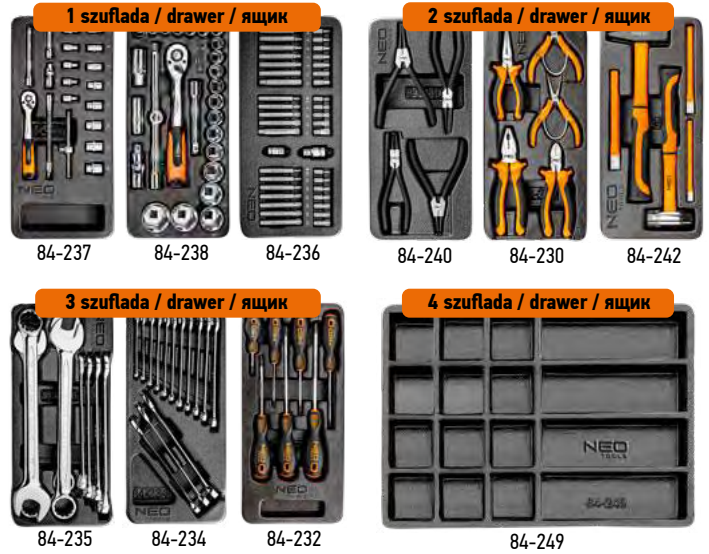

Ref.	D [mm]	W [mm]	H [mm]	capacity [kg]	☒	EAN
84-222+G	460	680	1030	280	0/1	5907558425857

Szczypce

Pliers set / Zange / Клепци / Πλασσοζυβί, набор / Fogókészlet / Set clește plat / Kleště / Kliešte, súprava / Klešče / Replės / Knaiblu komplekts / Nāpītsate komplekt / Щипцы / Klijēšta / Klesta set / Συλλογή πεισών / Alicates / Pinza / Pinças / Pince / Tangen

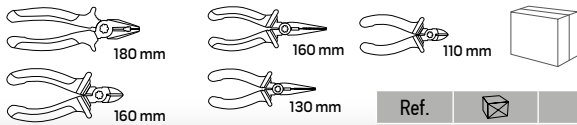
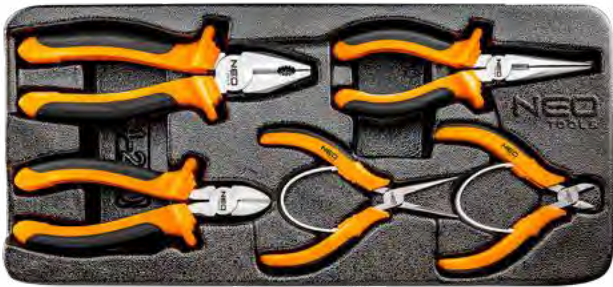

Ref.	☒	EAN
84-230	0/10	5907558424270

Szczypce do pierścieni osadczych

Circlip pliers / Zange für Stellringe / Щипцы для стопорных колец / Щипці для стопорних кільць / Zégergyűrű fogókészlet / set clește cu spirală / Kleště pro stavěcí kroužky / Segerky vonkajšie rovné / Klešče seger / Replės žiedams / Sprostgredzenu stangas / Vedrunāpītsad / Клепци Зезеп / Kružna Klijēšta / Kružna klesta / Ασφαλειοταιμιπίδες / Alicates para anillos de asiento / Set di pinze per anelli elastici / Pinças p. Anéis / Pince pour bagues de retenue / Tang voor dopringen

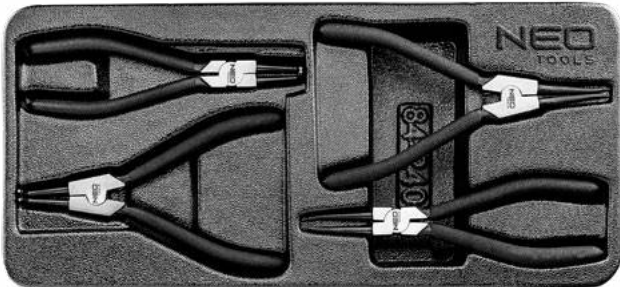

180 mm, zewnętrzne, proste / external, straight tip / щипцы для внешних/прямые
 170 mm, zewnętrzne, wygięte / external, bent tip / щипцы для внешних/загнутые
 180 mm, wewnętrzne, proste / internal, straight tip / щипцы для внутренних/прямые
 170 mm, wewnętrzne, wygięte / internal, bent tip / щипцы для внутренних/загнутые

Ref.	☒	EAN
84-240	0/10	5907558424379

Zestaw narzędzi

Tools set / Werkzeugsatz / Набор инструментов / Набор інструментів / Szerszámkészlet / Set scule de grădiniță / Sada nářadí / Súprava náradia / Garnitura orodja / Įrankių komplektas / Instrumentu komplekts / Тööriistakomplekt / Геодре комплект / Set uređaja / Set alata / Συλλογή εργαλείων / Juego de herramientas / Set utensili / Kit de ferramentas / Jeu d'outils / Gereedschapsset

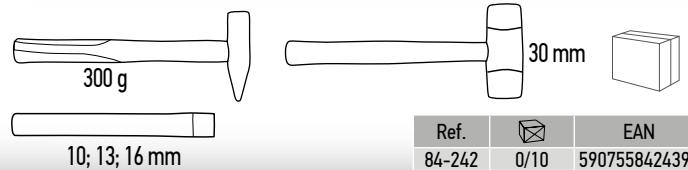

Ref.	☒	EAN
84-242	0/10	5907558424393

Pilniki

Files / Feilen / Напильники / Напильни / Reszelő készlet / Pile / Pilniki / Pilníky / Pile / Dildés / Viles / Viilid / Пулу / Turpije / Turpije / Лицец / Sopletes / Set di lime / Limas / Limes / Vijlen



Ref.	☒	EAN
84-244	0/10	5907558424416



Wkrętaki

Screwdriver set / Schraubendreher / Отвертки / Відкрутки, набір / Fogókészlet / Set şurubelnițe / Šroubováky / Súprava skrutkovačov / Garnitura izvijačev / Atsuktuvai / Skruvgriežu komplekts / Kruvikeerajate komplekt / Отвертки компл. / Odvijajući / Odvijac set / Συλλογή από κατασβίδια / Destornilladores / Set giravite piatti / Chaves de fenda / Tournevis / Schraevendraaiers



⊖ 3.0 x 75; 5.5 x 100; 5.5 x 200; 6.5 x 38; 6.5 x 125; 6.5 x 150; 8.0 x 150 mm

Ref.	⊠	EAN
84-231	0/10	5907558424287



⊕ PH0 x 75 mm; PH1 x 75 mm; PH1 x 100 mm; PH2 x 38 mm; PH2 x 100 mm; PH2 x 150 mm; PH3 x 150 mm

Ref.	⊠	EAN
84-232	0/10	5907558424294



⊕ PH00; PH0; PH1 ⊕ T10; T15; T20; T25
⊕ PZ0; PZ1; PZ2 ⊖ SL 2mm; SL 3mm

Ref.	⊠	EAN
84-247	0/10	5907558424447

Klucze nasadowe

Drive socket set / Steckschlüssel / Набор сменных головок / Ключи торцевые / Dugókulcskészlet / Trusa tubulare / Nástrčné kľúče / Nástrčné kľúče / Nasadni ključ / Veržlerakció antgali / Nomaināmo galvu komplekts / Padrunvõtmēd / Сменяемые наконечники за ключовые / Nasadni ključevi / Ključevni natikači / Σετ με καρούβια / Llaves de vaso / Set busssole / Chaves articuladas / Clefs à douilles / Dopsleutels

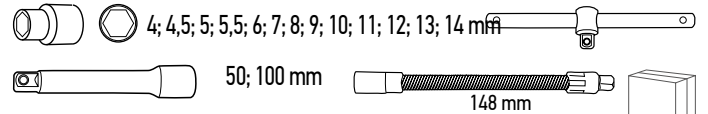

155 mm 1/4"

Ref.	⊠	EAN
84-237	0/10	5907558424348

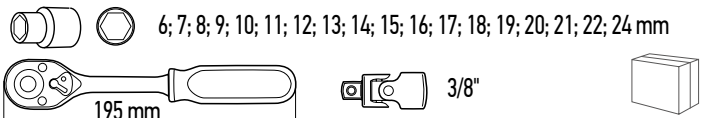

75 mm 3/8"

Ref.	⊠	EAN
84-239	0/10	5907558424362

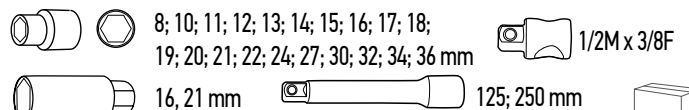

1/2M x 3/8F 1/4"

Ref.	⊠	EAN
84-238	0/6	5907558424355



Nasadki udarowe

Impact sockets / Schlagaufsätze / Nasadki uderne / Патроны перфораторни / Gépi dugókulcs készlet / Bråtare percutante / Priklerové nástavce / Priklerové nástavce / Udarne nasadni ključ / Kalimo antgaliai / Trecienuzgali / Lööksotsakud / Ударни наставкаи / Udarne nasadci / Udarne kapice / Υποδοχές κρουστικού αντάλλακτικού / Llaves de vaso para atornilladores de impacto / Set bussole a percussione / Bocais de impacto / Douilles de choc / Slagdoppen

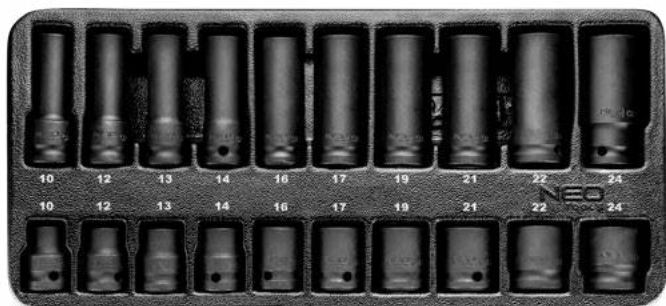

10; 12; 13; 14; 16; 17; 19; 21; 22; 24 mm

Ref.	☒	EAN
84-241	0/10	5907558424386

Nasadki sześciokątne długie

Hexagonal sockets / Sechskantaufsätze / Головки сменные шестигранные / Nasadki szóstokątne / Dugókulcs hosszú készlet / Capete tubulare hexagonale / Šestihranné nástavce / Šestihranné nástavce / Šestkotni nasadni ključ / Šešiakampiai antgaliai / Šešstūra nomaiņām galvas / Kuuskantpadrunid / Шестогълни наставкаи / Šesterokutne kapice / Šestougaone nasadke / Καρυδάκια εξαγωνα / Vasos hexagonales / Set bussole / Bocais hexagonais / Douilles à 6 pans / Zeskant doppen

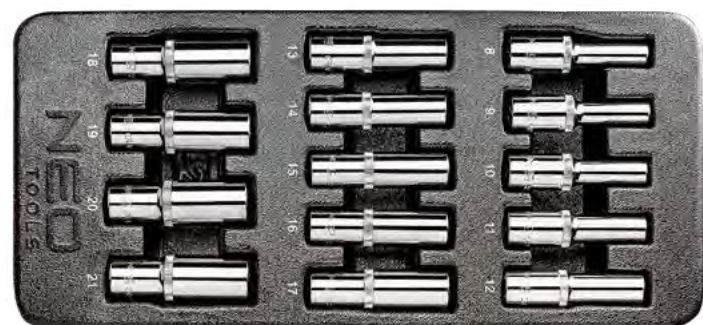

8, 9, 10, 11, 12, 13, 14, 15, 16, 17, 18, 19, 20, 21 mm

Ref.	☒	EAN
84-243	0/10	5907558424409

Końcówki wkrętaskowe

Driver bits / Einsätze für Schraubendreher / Nasadki / Наконечники викруткои / Bitkészlet / Set biti / Šroubovákové nástavce / Skrutkovacie nástavce / Nastavki za izvijače / Atsuktuvo antgaliai / Skřůvgrieža uzgali / Krivikeerajatsakud / Накрайници за отвертка / Nastavci za odvijač / Nastavci za odvijač / Καταβιβόμενες / Puntas destornilladoras / Set inserti / Ponteiros chave de fenda / Embouts de tournevis / Schroevendraaiereindstukken

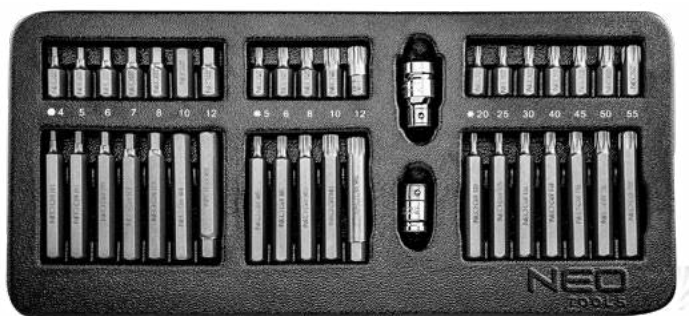

H4; H5; H6; H7; H8; H10; H12 H4; H5; H6; H7; H8; H10; H12
M5; M6; M8; M10; M12 M5; M6; M8; M10; M12
T20; T25; T30; T40; T45; T50; T55 T20; T25; T30; T40; T45; T50; T55

Ref.	☒	EAN
84-236	0/10	5907558424331

75 mm 30 mm

Klucze płasko-oczkowe

Ratchet wrench set / Maul-Ringschlüssel / Ключи комбинированные / Ключи ріжково-накидні, набір / Csillag-villáskulcs készlet / Set chei cu clichet / Očkoloché klíče / Súprava OP račňových klúčov / Ključ viličasto-obročni / Raktas plokščias - kilpinis / Kombinēto atslēgu komplekts / Pörkmutrivõtmete komplekt / Ключ звездозащечен / Set ključeva / Ključ kombinovani / Συλλογή πολυγώνων καστανιάς / Llaves combinadas (de estrella y a carraca abierta) / Set chiavi combinate / Chaves planas-de luneta / Clefs à fourche polygonales / Moersleutels

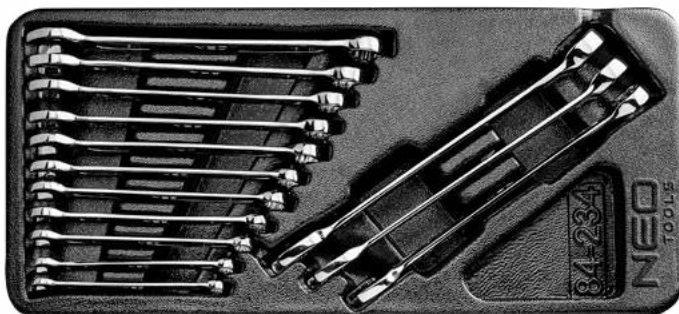

6x100; 7x110; 8x120; 9x130; 10x140; 11x150; 12x160; 13x170; 14x180; 15x190; 16x200; 17x210; 18x220; 19x230 mm

Ref.	☒	EAN
84-234	0/10	5907558424317

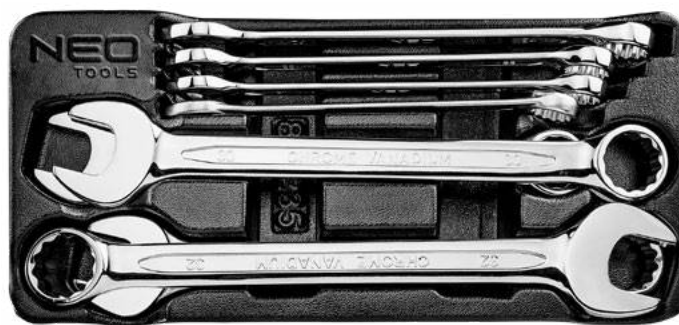

20x240; 21x250; 22x260; 24x280; 27x310; 29x340; 30x340; 32x360 mm

Ref.	☒	EAN
84-235	0/10	5907558424324

Klucze oczkowe odgięte

Offset ring spanner set / Ringschlüssel gebogen / Ключи накидные колеччатые / Ключи накидні коліщчаті, набір / Csillagkulcs készlet / Set chei inelare de deviație / Očkový klíč vyhnutý / Súprava očkových klúčov / Garnitura obroččnih ključev, upognjenih / Kilpinii, lenktų raktų komplektas / Kombinēto izliekto atslēgu komplekts / "Ofset" mutrivõtmete komplekt / Ключ луна / Ključ okasti / Ključ okasti set / Συλλογή κυρτών πολυγώνων κλειδίων με κεκλιμένη κεφαλή / Llaves de estrella, acodadas / Set chiavi inclinate ad anello / Chaves de luneta curvadas / Clefs polygonales contre-coudées / Gebogen ringsleutels

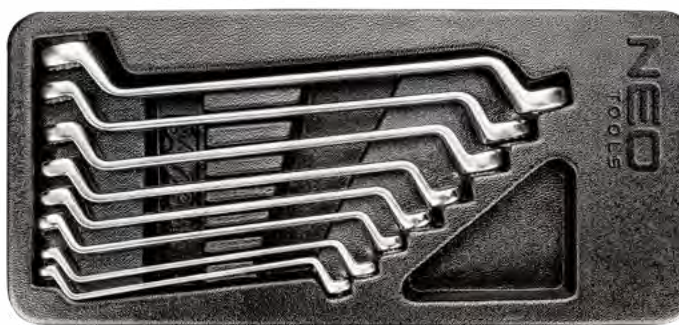

6x7; 8x9; 10x11; 12x13; 14x15; 16x17; 18x19; 20x22 mm

Ref.	☒	EAN
84-233	0/10	5907558424300



Klucze sześciokątne

Hex key wrench set / Sechskantschlüssel / Ключи шестигранные / Ключи шестигранны / Imbuskulcs készlet / Set chei hexagonale / Kľiče šesťhranné / Súprava predĺ. Imbus kľúčov s guľkou / Garnitura kľučev inbus / Šešćakampijai raktai / Seškanšu atslēgu komplekts / Kuuskant-mutrivõtmete komplekt / Шестоугълни ключове / Kľuč imbus set / Kľuč imbus / Εξαγωνικά κλειδιά / Llaves allen / Chiavi esagone / Chaves hexagonais / Clefs à 6 pans / Zeskantsleutels



25 years
GUARANTEE

S2
steel

x6



DOUBLE
COMPONENT
HANDLE

● H4; H5; H6; H7; H8; H10; H12

Ref.	📦	EAN
84-254	1/12	5907558483956

Klucze Torx

Torx key set / Torx-Schlüsselset / Ключи torx / Набор крестовых шестигранных торцовых ключей «torx» / Torx kulcskészlet / Set chei torx / Kľiče Torx / Torxové kľiče / Kľučič torx / Torciniai raktai / Atslēgas torx / Torx-võtmed / Ключове torx / Set torx kľučeva / Torx kľučevi / Σετ κλειδιών torx / Llaves torx / Chiavi torx / Chaves torx / Clefs Torx / Torxsleutels



25 years
GUARANTEE

S2
steel

x6



DOUBLE
COMPONENT
HANDLE

★ T10; T15; T20; T25; T30; T45

Ref.	📦	EAN
84-264	1/12	5907558483963

Narzynki i gwintowniki

Tap and die set / Schneideisen und Gewindebohrer / Плашки и метчики / Позначники ѓ плашки, набір / Menetkészítő készlet / Set scule tăiere filet interior și exterior / Závitnice a zăvitníky / Súprava zăvitníkov / Garnitura vreznikov in nareznikov navoja / Sriegpjovės ir sriegikliai / Vītņgriežu komplekts / Kraai ja valuvormi komplekt / Метчицу и плашки / Nareznice i ureznicne set / Set ureznika i nareznika / Ελικοκόφτες και κολαούζα / Cojinetes y machos de roscar, juego / Set di filiere a maschi / Cassonetes e roscas / Filières et tarauds / Snijplaat en schroefdraad snijtoestel

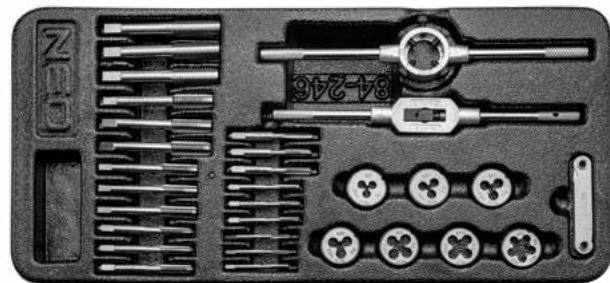

25 years
GUARANTEE

TUV Rheinland
CERTIFIED

HSS
steel

x31

DIN
352



⊘ M3; M4; M5; M6; M8; M10; M12 - 25 x 9 mm

Ref.	📦	EAN
84-246	0/10	5907558424430

Wkład profilowany

Profiled insert / Profileinsatz / Профилированный вставной элемент / Органайзер / Tároló rekeszes tálcá / Cartuş profilat / Profilovaná vložka / Profilovaná vložka / Profiliran vložek / Profiliuotas įdėklas / Profilēts ieliekamais elements / Profilitud tihend / Профилен элемент / Profilirani umetak / Profilsani umetak / Διατάχτη ένθετο εξάρτημα / Bandeja clasificadora perfilada / Vassoio / Cartuco perfilado / Cylindr profilē / Geprofileerde inzetdeel



25 years
GUARANTEE

FULL
DRAWER

550x386 mm

Ref.	📦	EAN
84-249	0/5	5907558424461



Klucze nasadowe

Socket wrenches / Steckschlüssel / Набор сменных головок / Ключи торцевые / Dugókulcskészlet / Trusa tubulare / Nástrčné kľúče / Nástrčné kľúče / Nasadni ključiči / Veržerakčio antgalia / Nomināmo galvu komplekts / Padrunvõtmed / Сменяеми накрайници за ключове / Nasadni ključevci / Ključevci natičaki / Зет ме карбџака / Llaves de vaso / Set di bussole SuperLock / Chaves tubulares / Clefs à douilles / Dopsleutels

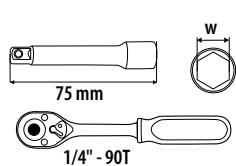

25
years
GUARANTEE



CrV
steel

x14

1/4"



1/2" SUPERLOCK - 8-10-11-12-13-14-15-16-17-18-19-21-22-24-27-30-32 mm

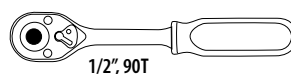

1/2", 90°

1/2" - 75, 125, 150 mm

1/2" - 3/8"
1/2"



25
years
GUARANTEE



CrV
steel

1/2"



x23



Ref.	W[mm]	⊠	EAN
10-000	4, 4.5, 5, 5.5, 6, 7, 8, 9, 10, 11, 12, 13	5/20	5907558466133

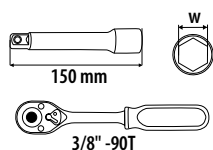

25
years
GUARANTEE



CrV
steel

x12

3/8"



23
elements

Ref.	⊠	EAN
08-694	1/5	5907558440034



Ref.	W[mm]	⊠	EAN
10-020	8, 10, 12, 13, 14, 16, 17, 19, 21, 22	5/10	5907558466157

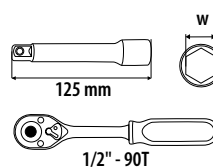

25
years
GUARANTEE



CrV
steel

x12

1/2"



1/2" SUPERLOCK -
8-9-10-11-12-13-14-15-16-17-18-19-20-21-22-23-24-25-26-27-28-29-30-32-34-35-36 mm

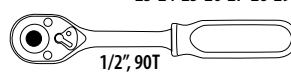

1/2", 90°

1/2" - 125, 150 mm

1/2" - 360 mm

1/2" 1/2" - 3/8"



25
years
GUARANTEE



CrV
steel

x33

1/2"



Ref.	W[mm]	⊠	EAN
10-030	8, 10, 12, 13, 14, 16, 17, 19, 21, 22	4/12	5907558466126



33
elements

Ref.	⊠	EAN
08-692	1/4	5907558440034





Klucze nasadowe

Socket wrenches / Steckschlüssel / Набор сменных головок / Ключи торцевые / Dugókulcskészlet / Trusa tubulare / Nástrčné kľúče / Nástrčné kľúče / Nasadni ključ / Veržlerakció antgaliai / Nomaināmo galvu komplekts / Padrinvõtmed / Сменными наконечниками за ключовые / Nasadni ključevi / Ključevi natičaki / Σετ με καρδιάκια / Llaves de vaso / Set di bussole SuperLock / Chaves tubulares / Clefs à douilles / Dopsuteults

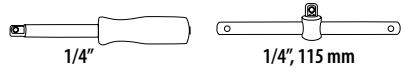
 1/2" SPLINE - 10-11-12-13-14-15-16-17-18-19-20-21-22-23
-24-27-30-32 mm
1/4" SPLINE - 4-4.5-5-5.5-6-7-8-9-10-11-12-13 mm

 1/4" 1/4", 115 mm

 1/2", 90T; 1/4", 90T 1/2" - 16, 21 mm

 1/2", 1/4" 1/2" - 3/8" 1/2" - 125, 250 mm
1/4" - 50 mm

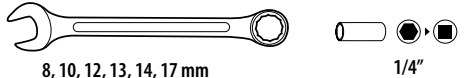
 8, 10, 12, 13, 14, 17 mm 1/4"

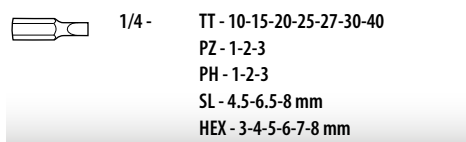
 1/4" TT - 10-15-20-25-27-30-40
PZ - 1-2-3
PH - 1-2-3
SL - 4.5-6.5-8 mm
HEX - 3-4-5-6-7-8 mm



25 years GUARANTEE

TÜV Rheinland CERTIFIED

CrV steel S2 steel

1/4" 1/2"

x71

PRECISE 4° 90T SPLINE

71 elements

STRONG CASE ERGO

Ref.	📦	EAN
08-690	0/10	5907558440010

 1/4" - 4-4.5-5-5.5-6-7-8-9-10-11-12-13-14 mm

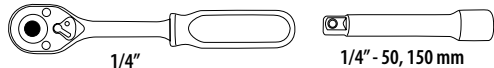
 1/4" 1/4" - 50, 150 mm

 1/4" - 150 mm 1/4"

 1/4" - 150 mm 1.4, 2, 2.5 mm

 1/4" 1/4" - 1/4"

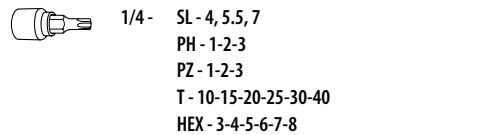
 1/4" SL - 4, 5.5, 7
PH - 1-2-3
PZ - 1-2-3
T - 10-15-20-25-30-40
HEX - 3-4-5-6-7-8



25 years GUARANTEE

TÜV Rheinland CERTIFIED

CrV steel

x46 1/4"

NEW PATENTED DESIGN PRECISE 4° 90T

46 elements

NEO TOOLS

Ref.	📦	EAN
10-004	1/10	5907558465945

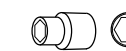
 1/4" - 4-4.5-5-5.5-6-7-8-9-10-11-12-13-14 mm

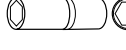
 1/4" - 6-7-8-10-11-12-13 mm

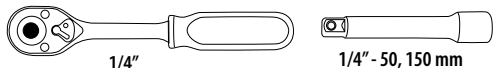
 1/4" 1/4" - 50, 150 mm

 1/4" - 150 mm 1/4"

 1/4" - 150 mm 1, 2, 1.5, 2, 2.5 mm

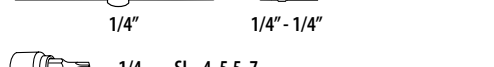
 1/4" 1/4" - 1/4"

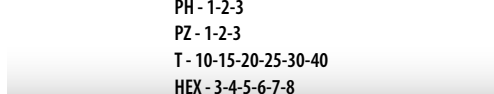
 1/4" SL - 4, 5.5, 7
PH - 1-2-3
PZ - 1-2-3
T - 10-15-20-25-30-40
HEX - 3-4-5-6-7-8



25 years GUARANTEE

TÜV Rheinland CERTIFIED

CrV steel x53

1/4"

PRECISE 4° 90T NEW PATENTED DESIGN

53 elements

NEO TOOLS

Ref.	📦	EAN
10-006	1/10	5907558466119



Klucze nasadowe

Socket wrenches / Steckschlüssel / Набор сменных головок / Ключи торцевые / Dugókulcskészlet / Trusa tubulare / Nástrčné kľúče / Nástrčné kľúče / Nasadni ključiči / Veržlerakció antgaliai / Nomaināmo galvu komplekts / Padrunvõtmed / Сменяемыми наконечниками за ключовые / Nasadni ključiči / Ključiči natikači / Σετ με καριδάκια / Llaves de vaso / Set di bussole SuperLock / Chaves tubulares / Clefs à douilles / Dopsleutels

1/2" - 10-11-12-13-14-15-16-17-18-19-20-
21-22-23-24-27-30-32 mm

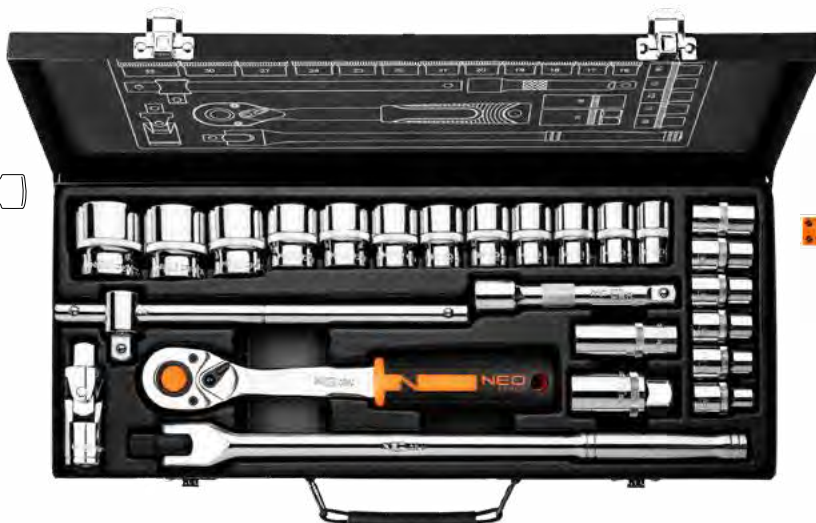
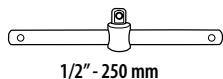
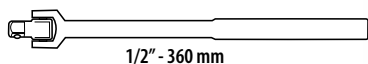
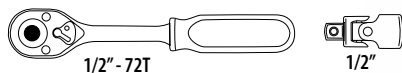

25 years
GUARANTEE



CrV
steel



x25

1/2"

25
elements

NEW
PATENTED
DESIGN



PRECISE
4°
90T

Ref.	⊠	EAN
10-036	1/4	5907558466058

3/4" - 19-21-22-23-24-26-27-29-
30-32-35-36-38-41-46-50 mm

3/4" - 100, 200, 400 mm

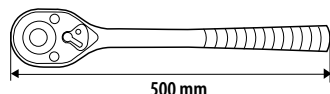

25 years
GUARANTEE



CrV
steel



x21

3/4"

21
elements

NEW
PATENTED
DESIGN

24

Ref.	⊠	EAN
08-061	0/1	5907558404173

1/4" - 4-4.5-5-5.5-6-7-8-9-
10-11-12-13-14 mm

1/4" - 4-4.5-5-5.5-6-7-8-9-
10-11-12-13-14 mm

1/4" - E4-E5-E6-E7-E8-E10

1/4" 1/4"

1/4" - 50; 100; 150 mm



1/4", 140 mm

1/4"



1/4" - TX - 8-10-15-20-25-30-40
PH - 1-2-3
PZ - 1-2-3
SL - 4-5.5-7 mm
HEX - 3-4-5-6-7-8 mm



25 years
GUARANTEE

CrV
steel

x63

1/4"

PRECISE
4°
90T

NEW
PATENTED
DESIGN



63
elements

Ref.	⊠	EAN
10-008	5/10	5907558466003



Klucze nasadowe

Socket wrenches / Steckschlüssel / Набор сменных головок / Ключи торцевые / Dugókulcskészlet / Trusa tubulare / Nástrčné kľúče / Nástrčné kľúče / Nasadni ključji / Veržlerakció antgaliai / Nomaināmo galvu komplekts / Padrunvõtmed / Сменными наконечниками за ключом / Nasadni ključevci / Ključevci natičasti / Σετ με καρυδάκια / Llaves de vaso / Set di bussole SuperLock / Chaves tubulares / Clefs à douilles / Dopsteutels

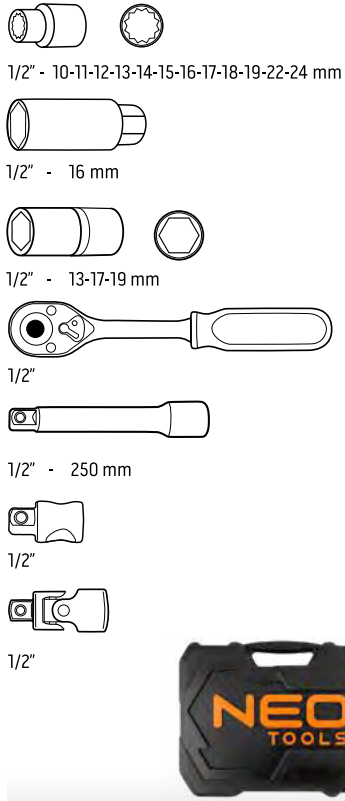

20
elements

Ref.	☒	EAN
10-032	1/5	5907558466140

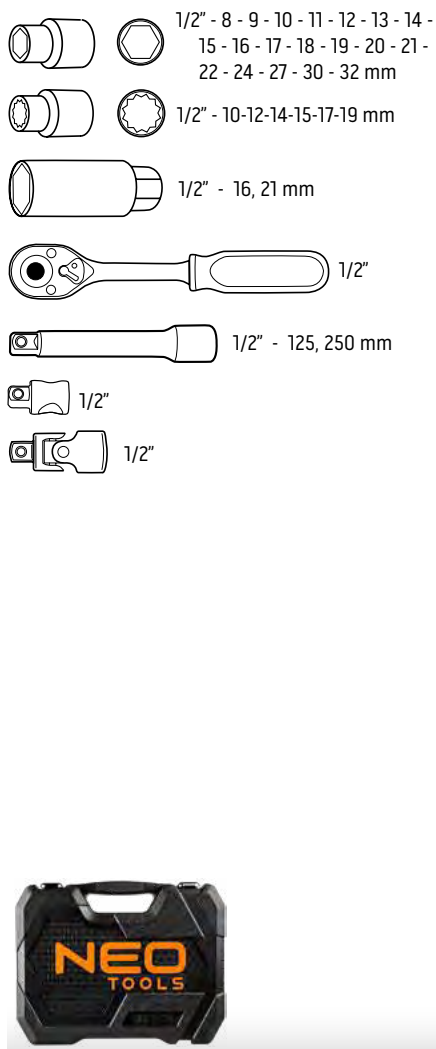

32
elements

Ref.	☒	EAN
10-038	1/5	5907558466096



Klucze nasadowe

Socket wrenches / Steckschlüssel / Набор сменных головок / Ключи торцевые / Dugókulcskészlet / Trusa tubulare / Nástrčné kľúče / Nástrčné klúče / Nasadni ključiči / Veržlerakció antgaliái / Nomaināmo galvu komplekts / Padrunvõtmed / Сменяемыми наконечниками за ключовые / Nasadni ključeviči / Ključeviči natičakāči / Σετ με καρούβια / Llaves de vaso / Set di bussolle SuperLock / Chaves tubulares / Clefs à douilles / Dopsleutels



1/2" - 10-11-12-13-14-15-16-17-18
-19-20-21-22-24-27-30-32 mm

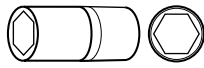

1/2" - 10-11-12-13-14-15-17-19 mm

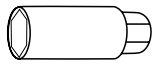

1/2" - 16, 21 mm

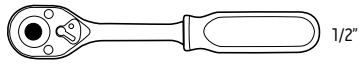

1/2"

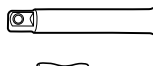

1/2" - 125, 250 mm



1/2"

1/2"

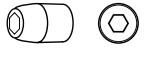

1/2" - 5/16"

5/16" - FD8-FD10-FD12

PH1-PH2-PH3-PH4

PZ1-PZ2-PZ3-PZ4

T20-T25-T30-T40-T45-T50-T55

H4-H5-H6-H8-H10-H12-H14



25 years
GUARANTEE



CrV
steel

x58 1/2"

PRECISE 4°
90T

NEW PATENTED DESIGN



58
elements



Ref.	⊞	EAN
10-042	1/4	5907558466072



1/2" - 14-15-16-17-18-19-20-22-24-27-30-32 mm
1/4" - 4-4.5-5-5.5-6-7-8-9-10-11-12-13-14 mm

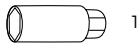

1/2" - 16, 21 mm

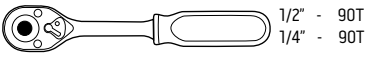

1/2" - 90T

1/4" - 90T

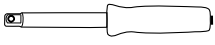

1/4" - 150 mm



1/4" - 150 mm



1/2"

1/2"

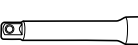

1/2" - 125, 250 mm

1/4" - 50, 100 mm

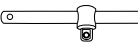

1/4" - 115 mm

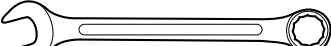

8-10-11-12-13-14-17-19-22 mm



1/2" - 5/16"

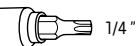

1/4" - SL4-SL5,5-SL7

PH1-PH2

PZ1-PZ2

T8-T10-T15-T20-T25-T30

H3-H4-H5-H6

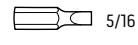

5/16" - SL8-SL10-SL12

PH3-PH4

PZ3-PZ4

T40-T45-T50-T55

H8-H10-H12-H14



25 years
GUARANTEE



CrV
steel

x82 1/4"

PRECISE 4°
90T

NEW PATENTED DESIGN



82
elements



ECO
Walczka wykonana z HDPE - materiału w 100% przerobialnego na granulát.
This case is made of HDPE - material 100% recyclable.

Ref.	⊞	EAN
10-058	1/4	5907558465921



Klucze nasadowe

Socket wrenches / Steckschlüssel / Набор сменных головок / Ключи торцевые / Dugókulcskészlet / Trusa tubulare / Nástrčné kľúče / Nástrčné kľúče / Nasadni ključji / Veržlerakció antgaliai / Nomaināmo galvu komplekts / Padrunvõtmed / Сменная накруйница за ключове / Nasadni ključevi / Ključevi natičaki / Σετ με καρυδάκια / Llaves de vaso / Set di bussole SuperLock / Chaves tubulares / Clefs à douilles / Dopsleutels



1/2" - 10-11-12-13-14-15-16-17-18-19
20-21-22-23-24-27 mm

1/4" - 4-5-5.5-6-7-8-10-11-12-13 mm

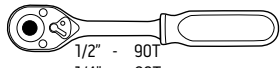

1/2" - 90T
1/4" - 90T

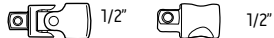

1/2" - 16, 21 mm

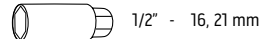

1/2" - 16, 21 mm

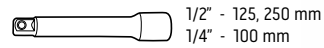

1/2" - 125, 250 mm
1/4" - 100 mm

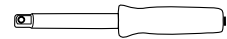

1/4" - 150 mm



1/4"



1.5-2-2.5 mm

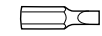

1/4" - TX8, TX10, TX15, TX20, TX25, TX27,
TX30, TX40, PH0, PH1, PH2, PH3,
PZ1, PZ2, PZ3, SL4, SLS.5, SL7, HEX 3,
4, 5, 6, 8, 10, 1/8", 9/64", 5/32",
3/16", 7/32", 1/4", 5/16", SPLINE 6, 8



25 years
GUARANTEE

TÜV Rheinland
CERTIFIED

CrV
steel

x73

1/4"

1/2"



PRECISE
4°
90T

NEW
PATENTED
DESIGN

MOTO BASE

73
elements



Ref.	⊞	EAN
10-054	1/4	5907558465938



1/2" - 14-15-16-17-18-19-20-22-24-27-30-32 mm

1/4" - 4-4.5-5-5.5-6-7-8-9-10-11-12-13-14 mm

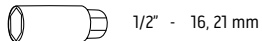

1/2" - 16, 21 mm



1/2" - 90T
1/4" - 90T



1/4" - 150 mm



1/4" - 150 mm

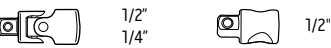

1/2" - 16, 21 mm
1/4" - 16, 21 mm



1/2" - 125, 250 mm
1/4" - 50, 100 mm



1/4" - 115 mm

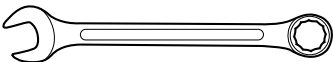

8-10-11-12-13-14-17-19-22 mm



1/2" - 5/16"

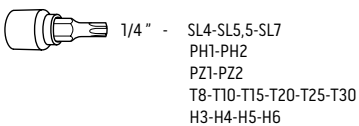

1/4" - SL4-SL5, S-SL7
PH1-PH2
PZ1-PZ2
T8-T10-T15-T20-T25-T30
H3-H4-H5-H6

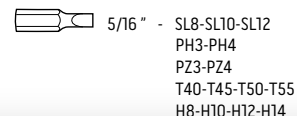

5/16" - SL8-SL10-SL12
PH3-PH4
PZ3-PZ4
T40-T45-T50-T55
H8-H10-H12-H14



25 years
GUARANTEE

TÜV Rheinland
CERTIFIED

CrV
steel

x82

1/4"

1/2"



PRECISE
4°
90T

NEW
PATENTED
DESIGN

MOTO BASE

82
elements



Ref.	⊞	EAN
10-059	1/4	5907558487695



Klucze nasadowe

Socket wrenches / Steckschlüssel / Набор сменных головок / Ключи торцевой / Dugókulcskészlet / Trusa tubulara / Nástrčné kľúče / Nástrčné ključice / Nasadni ključiči / Veržlerakció antgaliak / Nomināmo galvu komplekts / Padrunvõtmed / Сменяемые наконечники за ключом / Nasadni ključiči / Ključiči natičaki / Set me karbidaka / Llaves de vaso / Set di bussole SuperLock / Chaves tubulares / Clefs à douilles / Dopsleutels

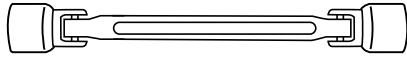
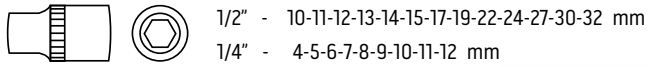

8-9 / 10-11 / 12-13 / 14-15 mm

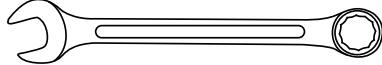

7-8-9-10-11-12-13-14-15-17-19 mm

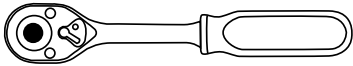

1/2", 72T
1/4", 72T

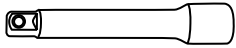

1/2" - 125, 250 mm
1/4" - 100 mm



1/2"
1/4"

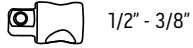

1/2" - 3/8"



1/4"

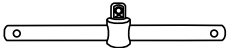

1/4", 115 mm



1/2" - 16, 21 mm



1/4"



1.5-2-2.5-5-6-8-10 mm



1/2", 30 mm - TX - 10-15-20-25-30
PH - 0-1-2-3
PZ - 1-2-3
SL - 3-4-5-5-7 mm
HEX - 2-3-4-5-6 mm



77
elements



Ref.	☐	EAN
08-915	1/4	5907558442120



Klucze nasadowe

Socket wrenches / Steckschlüssel / Набор сменных головок / Ключи торцевые / Dugókulcskészlet / Trusa tubulare / Nástrčné kľúče / Nástrčné kľúče / Nasadni ključji / Veržlerakció antgalliai / Nomaināmo galvu komplekts / Padrinvõtmed / Сменная накруйница за ключеве / Nasadni ključevci / Ključevci natikači / Σετ με καρδιάκια / Llaves de vaso / Set di bussole SuperLock / Chaves tubulares / Clefs à douilles / Dopsleutels

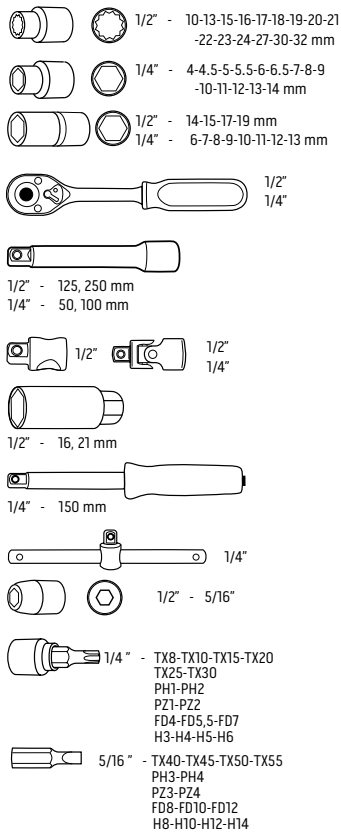

25 years
GUARANTEE

TÜVRheinland
CERTIFIED

CrV
steel

x86 1/4"

PRECISE 4° 90T 1/2"

NEW PATENTED DESIGN

+

+

+

+



86
elements



Ref.	⊞	EAN
10-060	1/4	5907558465976

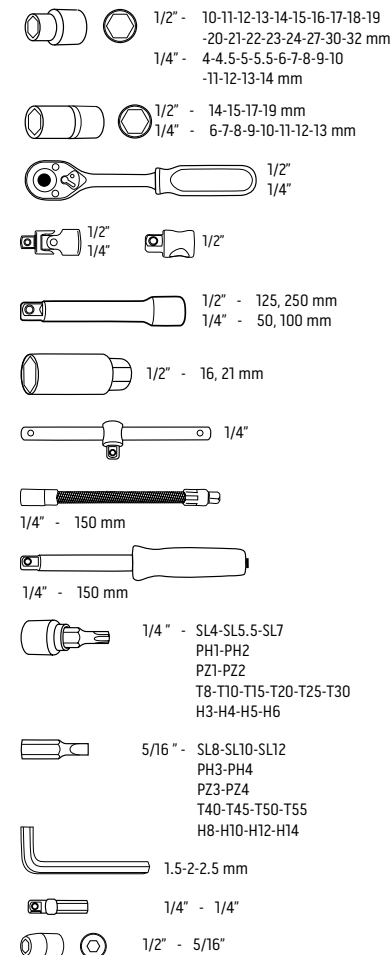

25 years
GUARANTEE

TÜVRheinland
CERTIFIED

CrV
steel

x94 1/4"

1/2"

PRECISE 4° 90T NEW PATENTED DESIGN

+

+

+



94
elements



Ref.	⊞	EAN
10-062	1/4	5907558465952



Klucze nasadowe

Socket wrenches / Steckschlüssel / Набор сменных головок / Ключи торцевой / Dugókulcskészlet / Trusa tubulara / Nástrčné kľúče / Nástrčné kľúče / Nasadni ključiči / Veržlerakció angaljai / Nomināmo galvu komplekts / Padrunvõtmed / Сменяемые наконечники за ключом / Nasadni ključevci / Ključevci natičaki / Σετ με καρυδάκια / Llaves de vaso / Set di bussole SuperLock / Chaves tubulares / Clefs à douilles / Dopsleutels

1/2" - 10-11-12-13-14-15-16-17-18-19-20-21-22-24-27-30-32 mm
1/4" - 4-4.5-5-5.5-6-7-8-9-10-11-12-13-14 mm

1/2" - 14-15-17-19-22 mm
1/4" - 6-7-8-9-10-11-12-13 mm

1/2" - E10-E11-E12-E14-E16-E18-E20-E24
1/4" - E4-E5-E6-E7-E8

1/2" - 16, 21 mm

1/2", 72T
1/4", 72T

1/2" - 125 / 250 mm
1/4" - 50 / 100 mm

1/2" 1/4" 1/2" - 3/8"

1/4"

1/4", 115 mm

1/4", 145 mm

1/2" - 5/16"

1/4"

1.27 - 1.5 - 2 - 2.5 mm

1/4" - TX - 8-10-15-20-25-27-30
PH - 1-2
PZ - 1-2
SL - 4-5-5-7 mm
HEX - 3-4-5-6 mm

1/2", 30 mm - TX - 40-45-50-55-60
PH - 3-4
PZ - 3-4
SL - 8-10-12 mm
HEX - 7-8-10-12-14 mm

25 years GUARANTEE

TÜV Rheinland CERTIFIED

CrV steel

x111

1/4"

1/2"



72T 1/4"

72T 3/8"

72T 1/2"

1/4"



111 elements



Ref.	1/4	EAN
08-910	1/4	5907558442113



Klucze nasadowe

Socket wrenches / Steckschlüssel / Набор сменных головок / Ключи торцевые / Dugókulcskészlet / Trusa tubulare / Nástrčné kľúče / Nástrčné kľúče / Nasadni ključji / Veržlerakció antgaliai / Nomaināmo galvu komplekts / Padrunvõtmed / Сменная накруйница за ключове / Nasadni ključevci / Ključevci natičaki / Σετ με καρδιάκια / Llaves de vaso / Set di bussole SuperLock / Chaves tubulares / Clefs à douilles / Dopsleutels



1/4" - 4-4.5-5-5.5-6-7-8-9-10-11-12-13-14 mm
1/2" - 10-11-12-13-14-15-17-19-20-21-22-24-27 mm

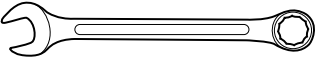
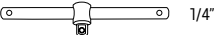
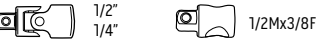
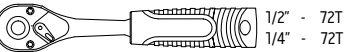
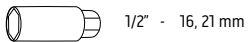

10-11-12-13-14-15-17-19 mm

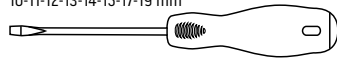

SL 5.5x38mm / SL 6.5x100mm
PH1x38mm / PH2x100mm



SL: 3-4-5-6-7-8
PH: 0-1-2-2-3
PZ: 0-1-2-2-3

T: 8-10-15-20-25-27-30-40-45
TT: 8-10-15-20-25-27-30-40-45
H: 3-4-5-5.5-6-8

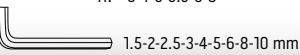

1/4" - 4-4.5-5-5.5-6-7-8-9-10-11-12-13-14 mm
1/2" - 10-11-12-13-14-15-16-17-18-19-20-21-22-24-27-30-32 mm

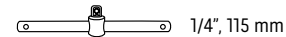
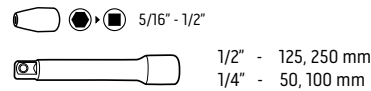
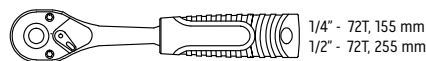
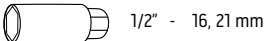
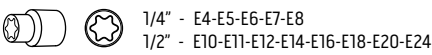
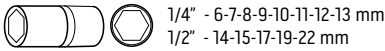

T: 40-45-50-55-60
H: 7-8-10-12-14
PH: 3-4
PZ: 3-4
SL: 8-10-12



1/4" - T: 8-10-15-20-25-27-30
PH: 1-2
PZ: 1-2
SL: 4-5-5-7
H: 3-4-5-6

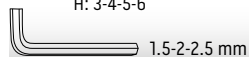

25 years
GUARANTEE

CrV steel
100 ELEMENTS
72T

STRONG CASE
ERGO

72T
1/4"

72T
1/2"

72T
1/4"

72T
1/2"

72T
1/4"

15/21/25/31/41/51/61/81/10 mm
x8

x4
1/4"



100 elements



Ref.	📦	EAN
10-206	1/3	5907558463224



25 years
GUARANTEE

CrV steel
x108
1/2" 1/4"

72T 1/4" 72T 1/2"

72T 1/4" 72T 1/2"

72T 1/4" 72T 1/2"

72T 1/4" 72T 1/2"

72T 1/4" 72T 1/2"

STRONG CASE
ERGO

72T 1/4" 72T 1/2"

72T 1/4" 72T 1/2"

72T 1/4" 72T 1/2"

72T 1/4" 72T 1/2"

72T 1/4" 72T 1/2"

72T 1/4" 72T 1/2"

72T 1/4" 72T 1/2"

72T 1/4" 72T 1/2"

72T 1/4" 72T 1/2"

72T 1/4" 72T 1/2"

72T 1/4" 72T 1/2"

72T 1/4" 72T 1/2"



108 elements



Ref.	📦	EAN
10-212	1/3	5907558468885



Klucze nasadowe

Socket wrenches / Steckschlüssel / Набор сменных головок / Ключи торцевые / Dugókulcskészlet / Trusa tubulara / Nástrčné kľúče / Nástrčné kľúče / Nasadni ključiči / Veržlerákció antigaljai / Nomināmo galvu komplekts / Padrunvārtmed / Сменная накрайница за ключове / Nasadni ključevci / Ključevci natičaki / Set με καρυδάκια / Llaves de vaso / Set di bussole SuperLock / Chaves tubulares / Clefs à douilles / Dopsleutels



1/4" - 4-4-5-5-5-6-7-8-9-10-11-12-13-14 mm
1/2" - 10-11-12-13-14-15-16-17-18-19-20-21-22-23-24-27-30-32 mm

1/2" - 16, 21 mm

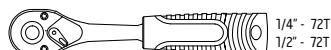

1/4" - 72T
1/2" - 72T



1/4" - 150 mm



1/2" - 125, 250 mm
1/4" - 75, 100 mm

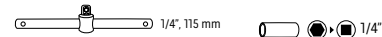

1/4", 115 mm



1/2Mx3/8F
1/4"

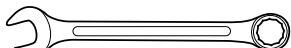

8-10-11-12-13-14-15-16-17-19 mm

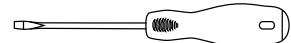

SL 5.5x38mm / SL 6.5x100mm
PH1x38mm / PH2x100mm



1/4"

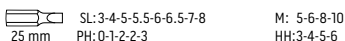

SL: 3-4-5-5-5-6-6-5-7-8 M: 5-6-8-10
PH: 0-1-2-2-3 HH: 3-4-5-6
PZ: 0-1-2-2-3 S: 1-2
T: 8-10-15-20-25-27-30-40-45 U: 4-6-8
TT: 8-10-15-20-27-30-40-45 X: 6-8-10
H: 5-5-6-6-5-7-8 Y: 1-2-3

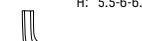

HEX: 1.5-2-2.5-3-4-5-6-8-10 mm
TORX: 10-15-20-25-27-30-40-45-50



25 years
GUARANTEE

138
ELEMENTS

CrV
steel

72T

STRONG
CASE

ERGO

+

+

+

+

+

+

+

+

+

+

+

+

+

1/4"

1/2"

72T
1/4"

72T
1/2"

1/4"

1/4"



x4 x10

138
elements

Ref.	⊞	EAN
10-208	1/2	5907558463231



1/4" - 4-4-5-5-5-6-7-8-9-10-11-12-13-14 mm
1/2" - 10-11-12-13-14-15-16-17-18-19-20-21-22-23-24-27-30-32 mm

1/4" - 4-5-6-7-8-10 mm
1/2" - 10-12-13-14-17-19 mm

1/2" - 16, 21 mm



1/4" - 72T
1/2" - 72T



1/4" - 150 mm



1/2" - 125, 250 mm
1/4" - 75, 100 mm

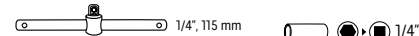

1/4", 115 mm

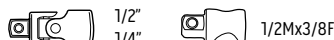

1/2Mx3/8F
1/4"

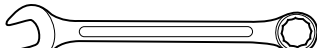

8-10-11-12-13-14-15-16-17-19 mm

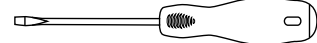

SL 5.5x38mm / SL 6.5x100mm
PH1x38mm / PH2x100mm



1/4"

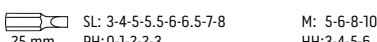

SL: 3-4-5-5-5-6-6-5-7-8 M: 5-6-8-10
PH: 0-1-2-2-3 HH: 3-4-5-6
PZ: 0-1-2-2-3 S: 1-2
T: 8-10-15-20-25-27-30-40-45 U: 4-6-8
TT: 8-10-15-20-27-30-40-45 X: 6-8-10
H: 5-5-6-6-5-7-8 Y: 1-2-3

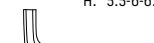

HEX: 1.5-2-2.5-3-4-5-6-8-10 mm
TORX: 10-15-20-25-27-30-40-45-50



25 years
GUARANTEE

150
ELEMENTS

CrV
steel

72T

STRONG
CASE

ERGO

+

+

+

+

+

+

+

+

+

+

+

+

+

1/4"

1/2"

72T
1/4"

72T
1/2"

1/4"

1/2"

1/4"

1/4"

+

x4

x10



150
elements

Ref.	⊞	EAN
10-210	1/2	5907558463248



Klucze nasadowe

Socket wrenches / Steckschlüssel / Набор сменных головок / Ключи торцевой / Dugókulcskészlet / Trusa tubulare / Nástrčné kľúče / Nástrčné ključice / Nasadni ključiči / Veržlerakció antgalliai / Nomaināmo galvu komplekts / Padrunvõtmed / Сменная накруйница за ключове / Nasadni ključeviči / Ključeviči natikači / Σετ με καρδιάκια / Llaves de vaso / Set di bussole SuperLock / Chaves tubulares / Clefs à douilles / Dopsleutels



156
elements



3/8" - 9-10-11-12-13-14-15-16-17-18-19 mm
1/4" - 4-4,5-5-5,5-6-7-8-9-10-11-12-13-14 mm

1/2" - 10-11-12-13-14-15-16-17-18-19
-20-21-22-24-27-30-32 mm

1/2" - 10-12-13-14-17-19 mm
3/8" - 10-11-12-13-14-15 mm
1/4" - 4-5-6-7-8-9 mm

1/2" - E20-E22-E24
3/8" - E10-E11-E12-E14-E16-E18
1/4" - E4-E5-E6-E7-E8

1/2" 3/8" 1/4" 3/8"(M)x 1/2"(F)

1/2" 3/8" 1/4"

1/2" - 125, 250 mm
3/8" - 75, 150 mm
1/4" - 50, 100 mm

1/4" - 150 mm

1/4"

3/8" - 16, 21 mm

8-9-10-11-12-13-14-15-16-17-18-19 mm

8x10 mm 12x13 mm 17x19 mm

3/8" - FD4-FD5,5-FD6,5
PH1-PH2-PH3
T30-T40-T45-T50-T55
H3-H4-H5-H6-H8-H10
PZ1-PZ2-PZ3

5/16" - FD4-FD5,5-FD7
PH1-PH2-PH3
T10H-T15H-T20H-T25H
T27H-T30H-T40H
ST20-ST25-ST30
HEX3-HEX4-HEX5-HEX6

1/4" 1.5-2-2.5-3-4-5-6-8-10 mm



Ref.	⊠	EAN
10-072	1/2	5907558466010



Klucze nasadowe

Socket wrenches / Steckschlüssel / Набор сменных головок / Ключи торцевые / Dugókulcskészlet / Trusa tubulara / Nástrčné kľúče / Nástrčné klúče / Nasadni ključiči / Veržlerákci antgaliai / Nomaināmo galvu komplekts / Padrunvõtmēd / Сменяемые наконечники за ключовые / Nasadni ključeviči / Ključeviči natičakci / Σετ με καρδιάκια / Llaves de vaso / Set di bussole SuperLock / Chaves tubulares / Clefs à douilles / Dopsleutels



1/4" - 4-4.5-5-5.5-6-7-8-9-10-11-12-13-14 mm
 3/8" - 10-11-12-13-14-15-16-17-18-19 mm
 1/2" - 10-11-12-13-14-15-16-17-18-19-20-21-22-24-27-30-32 mm

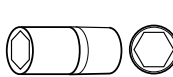

1/4" - 4-5-6-7-8-9-10 mm
 3/8" - 10-11-12-13-14-15 mm
 1/2" - 16-17-18-19-22 mm



1/4" - E4-E5-E6-E7-E8
 3/8" - E10-E11-E12-E14-E16-E18
 1/2" - E20-E24



3/8" - 14, 18 mm
 1/2" - 16, 21 mm

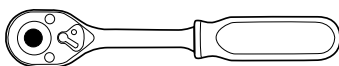

1/4" - 90T
 3/8" - 90T
 1/2" - 90T



1/4"

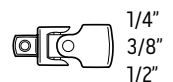

1/4"
 3/8"
 1/2"

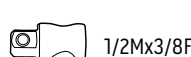

1/2Mx3/8F

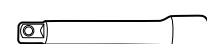

1/4" - 50, 100 mm
 3/8" - 150 mm
 1/2" - 125, 250 mm

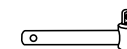

1/4"



1/4" - 8 mm
 3/8" - 8 mm
 1/2" - 10 mm



1/4" - T: 8-9-10-15-20-25-27-30
 TT: 8-9-10-15-20-25-27-30
 PH: 0-1-2
 PZ: 0-1-2
 SL: 4-5.5-6.5-7
 H: 3-4-5-6



1/4"

T: 10-15-20-25-27-30
 TT: 15-20-25-30-40
 H: 3-4-5-6-7
 PH: 0-1-2-3
 PZ: 1-2-3
 SL: 4-5.5-5.5-7
 S: 1-2-3

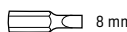

8 mm



10 mm

T: 40-45-50 T: 55-60-70
 TT: 40-45-50 TT: 55-60-70
 H: 7-8-10-12-14
 PH: 3-4
 PZ: 3-4
 SL: 8-10-12



1.27-1.5-2-2.5-3-4-5 mm



182
elements



CrV steel

x182

1/4"

3/8"

1/2"



PRECISE
4°
90T

NEW
PATENTED
DESIGN



Ref.	⊠	EAN
10-074	1/2	5907558466027



Klucze nasadowe

Socket wrenches / Steckschlüssel / Набор сменных головок / Ключи торцевые / Dugókulcskészlet / Trusa tubulare / Nástrčné kľúče / Nástrčné kľúče / Nasadni ključji / Veržlerakció antgaliai / Nomaināmo galvu komplekts / Padrunvõtmed / Сменными наконечниками за ключовые / Nasadni ključevji / Ključevji natičaki / Σετ με καρδιάκια / Llaves de vaso / Set di bussolle SuperLock / Chaves tubulares / Clefs à douilles / Dopsleutels

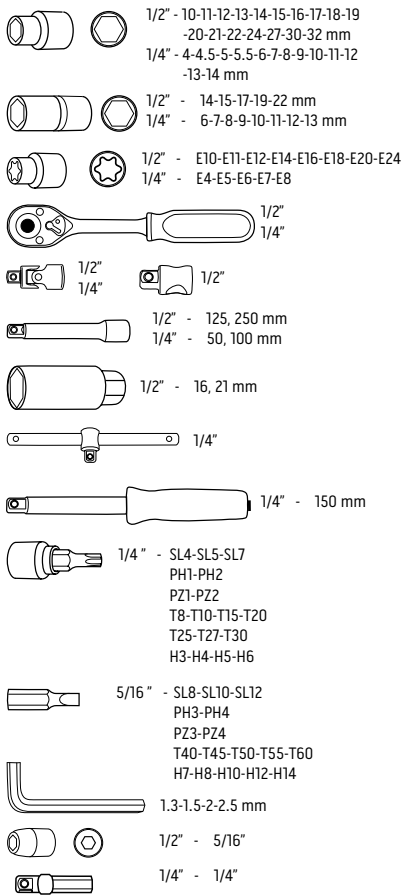

25 years
GUARANTEE



CrV
steel

x110

1/4"

1/2"



PRECISE
4
90T



110
elements



Ref.	⊠	EAN
10-066	1/4	5907558465891

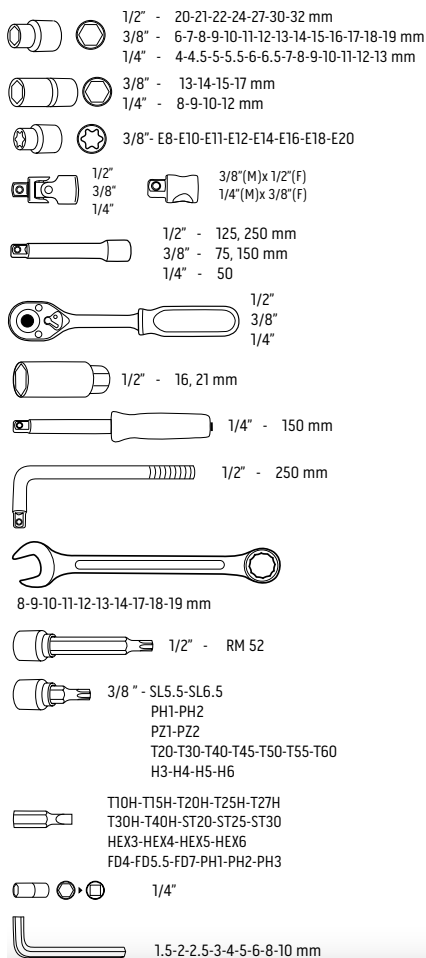

25 years
GUARANTEE



CrV
steel

x126

1/4"

3/8"

1/2"



PRECISE
4
90T



126
elements



Ref.	⊠	EAN
10-070	1/2	5907558466034



Klucze nasadowe

Socket wrenches / Steckschlüssel / Набор сменных головок / Ключи торцевые / Dugókulcskészlet / Trusa tubulara / Nástrčné kľúče / Nástrčné klúče / Nasadni ključji / Veržlerakció antgaliai / Nomaināmo galvu komplekts / Padrunvītmed / Сменными наконечниками за ключовые / Nasadni ključevji / Ključevji natičaki / Set με καρύδακια / Llaves de vaso / Set di bussole SuperLock / Chaves tubulares / Clefs à douilles / Dopsleutels



1/4" - 4-4.5-5-5.5-6-7-8-9-10-11-12-13-14 mm
 3/8" - 10-11-12-13-14-15-16-17-18-19 mm
 1/2" - 10-11-12-13-14-15-17-19-20-21-22-24-27-30-32 mm



1/4" - 4-5-6-7-8-9-10 mm
 3/8" - 10-11-12-13-14-15 mm
 1/2" - 16-17-18-19-22 mm



1/4" - E4-E5-E6-E7-E8
 3/8" - E10-E11-E12-E14-E16-E18
 1/2" - E20-E22-E24

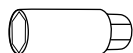

3/8" - 18 mm
 1/2" - 16, 21 mm

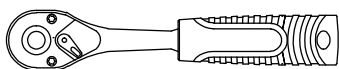

1/4" - 72T 3/8" - 72T 1/2" - 72T

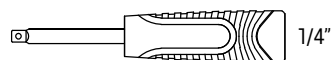

1/4"

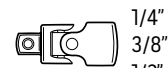

1/4"
 3/8"
 1/2"

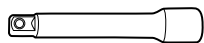

1/4" - 50, 100 mm
 3/8" - 150 mm
 1/2" - 125, 250 mm



1/4" - 115 mm
 1/2" - 250 mm

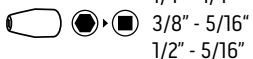

1/4" - 1/4"
 3/8" - 5/16"
 1/2" - 5/16"

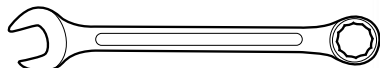

8-10-11-12-13-14-15-16-17-18-19-22 mm

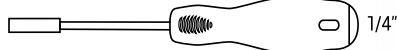

1/4"

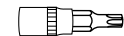

1/2" - T: 55-60
 1/4" - T: 25-27-30-35-40-45-50
 TT: 27-30-35-40-45-50
 PH: 3-4
 PZ: 3-4
 SL: 6-6.5-8
 H: 5.5-6-6.5-7-8
 M: 5-6-8-10

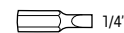

1/4"
 T: 25-27-30-35-40-45 M: 5-6-8-10
 TT: 27-30-35-40-45 HH: 3-4-5-6
 H: 5.5-6-6.5-7-8 S: 1-2
 PH: 1-2-3 U: 4-6-8
 PZ: 1-2-3 X: 6-8-10
 SL: 6-6.5-8 Y: 1-2-3



5/16"
 T: 25-27-30-35-40-45-50
 TT: 27-30-35-40-45-50
 H: 5.5-6-6.5-7-8
 PH: 3-4
 PZ: 3-4
 SL: 6-6.5-8
 M: 5-6-8-10



1.27-1.5-2-2.5-3-4-5 mm



216
elements



Ref.	⊞	EAN
10-216	1/2	5907558463255



Klucze nasadowe

Socket wrenches / Steckschlüssel / Набор сменных головок / Ключи торцевой / Dugókulcskészlet / Trusa tubulare / Nástrčné kľúče / Nástrčné kľúče / Nasadni ključiči / Veržlerakció antgaliái / Nomaināmo galvu komplekts / Padrūvrotmed / Сменная накруйница за ключове / Nasadni ključeviči / Ključeviči natičakči / Σετ με καρυβάκια / Llaves de vaso / Set di bussole SuperLock / Chaves tubulares / Clefs à douilles / Dopsleutels



1/2" - 10-11-12-13-14-15-17-19-20-21-22-24-27-30-32 mm

3/8" - 10-11-12-13-14-15-16-17-18-19 mm

1/4" - 4-4.5-5-5.5-6-7-8-9-10-11-12-13-14 mm



1/2" - 16-17-18-19-22 mm

3/8" - 10-11-12-13-14-15 mm

1/4" - 4-5-6-7-8-9-10 mm



1/2" - E18-E20-E22-E24

3/8" - E8-E10-E12-E14-E16

1/4" - E4-E5-E6-E7-E8

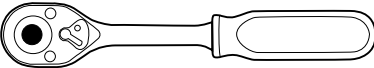

1/2" - 90T; 3/8" - 90T; 1/4" - 90T

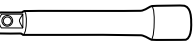

1/2" - 125, 250 mm

3/8" - 125 mm

1/4" - 50, 100 mm



1/2" - 16, 21 mm

3/8" - 18 mm



1/2"

3/8"

1/4"



1/2" - T55-T60

1/4" - SL4-SL5.5-SL6.5-SL7

PZ1-PZ2-PZ3, PH1-PH2-PH3

T8-T9-T10-T15-T20-T25-T27-T30

TT8-TT9-TT10-TT15-TT20-TT25-TT27-TT30

H3-H4-H5-H6

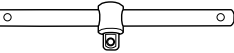

1/4" - 115 mm

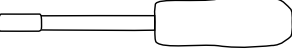

1/4" - 210 mm



1/4" - 150 mm

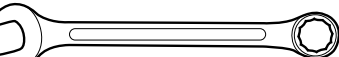

8-9-10-11-12-13-14-15-16-17-18-19 mm



5/16" - T25-T27-T30-T35-T40-T40-T45-T50

H5.5-H6-H7-H8, SL6-SL6.5-SL8

PH3-PH4, PZ3-PZ4, M5-M6-M8-M10



1/4" - H3, H4, H5, H6, H3, H4, H5, H6

PH1, PH2, PZ1, PZ2, T8, T10, T15, T20,

T25, TT10, TT15, TT20, TT25, TT40,

TT8, TT10, TT20, TT25, M5, M6,

M8, SL4, SL5, SL5.5, TRI-WING 1, 2, 3,

TORQ 6, 8, 10, S1, S2, SL4, SL6, SL8

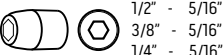

1/2" - 5/16"

3/8" - 5/16"

1/4" - 5/16"

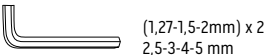

(1,27-1,5-2mm) x 2

2,5-3-4-5 mm



Ref.	⊞	EAN
10-076	1/2	5907558465907



Klucze nasadowe

Socket wrenches / Steckschlüssel / Набор сменных головок / Ключи торцевые / Dugókulcskészlet / Trusa tubulare / Nástrčné kľúče / Nástrčné klúče / Nasadni ključji / Veržlerakció antgaliai / Nomaināmo galvu komplekts / Padrunvārtmed / Сменяемыми наконечниками за ключовые / Nasadni ključevji / Ključevji natičakci / Set me karubakia / Llaves de vaso / Set di bussole SuperLock / Chaves tubulares / Clefs à douilles / Dopsleutels



1/2" - 10-13-15-16-17-18-19-20-21-22-23-24-27-30-32 mm
 7/16", 1/2", 9/16", 5/8", 11/16", 3/4", 13/16", 7/8"
 3/8" - 10-11-12-13-14-15-16-17-18-19 mm
 1/4" - 3.5-4-4.5-5-5.5-6-6.5-7-8-9-10-11-12-13-14 mm
 3/8", 11/32", 5/16", 9/32", 1/4", 5/32", 3/16"

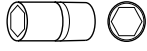

1/2" - 15-16-17-18-19-22 mm
 3/8" - 10-11-12-13-14-15 mm
 1/4" - 4-5-6-7-8-9-10 mm



1/2" - E16-E18-E20-E22-E24
 3/8" - E10-E11-E12-E14
 1/4" - E4-E5-E6-E7-E8

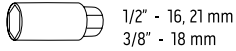

1/2" - 16, 21 mm
 3/8" - 18 mm

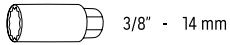

3/8" - 14 mm

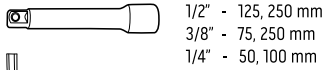

1/2" - 125, 250 mm
 3/8" - 75, 250 mm
 1/4" - 50, 100 mm

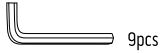

9pcs

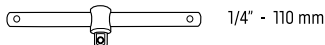

1/4" - 110 mm



1/4"

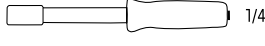

1/4"



1/4"

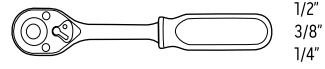

1/2"
 3/8"
 1/4"

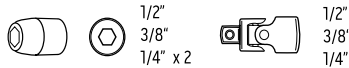

1/2"
 3/8"
 1/4" x 2



1/2"
 3/8"



1/4" 1/4"x1/4"
 1/4"x3/8"

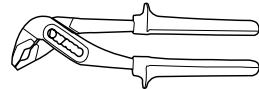
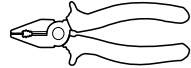

8-9-10-11-12-13-14-15-17-19-22 mm



L=75mm
 8pcs



5/16" L=30mm
 24pcs



L=25mm
 60pcs



233
elements



Ref.	☐	EAN
10-078	1/2	5907558465914



Klucze nasadowe

Socket wrenches / Steckschlüssel / Набор сменных головок / Ключи торцевые / Dugókulcskészlet / Trusa tubulare / Nástrčné kľúče / Nástrčné ključice / Nasadni ključji / Veržlerakció antgaliai / Nomaināmo galvu komplekts / Padrūvīnīdmed / Сменная накруйница за ключове / Nasadni ključevci / Ključevci natičaki / Σετ με καρδιάκια / Llaves de vaso / Set di bussole SuperLock / Chaves tubulares / Clefs à douilles / Dopsleutels

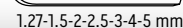
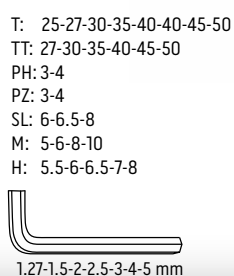
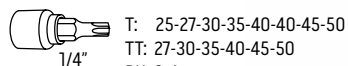
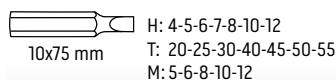
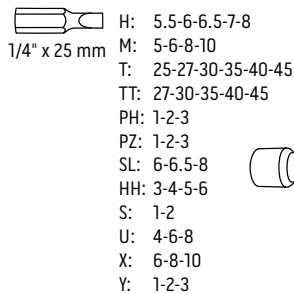
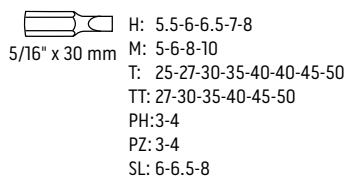
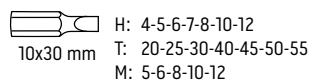
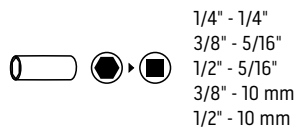
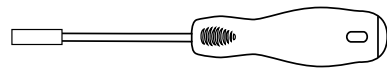
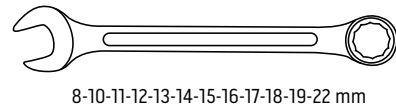
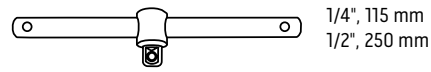
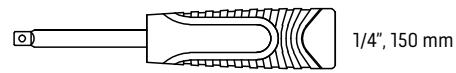
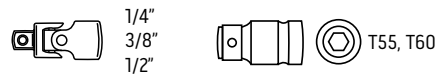
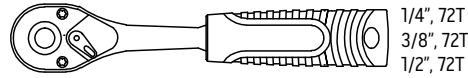
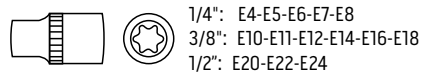
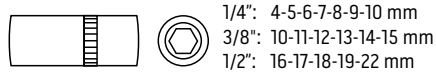
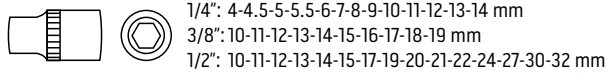

300
elements

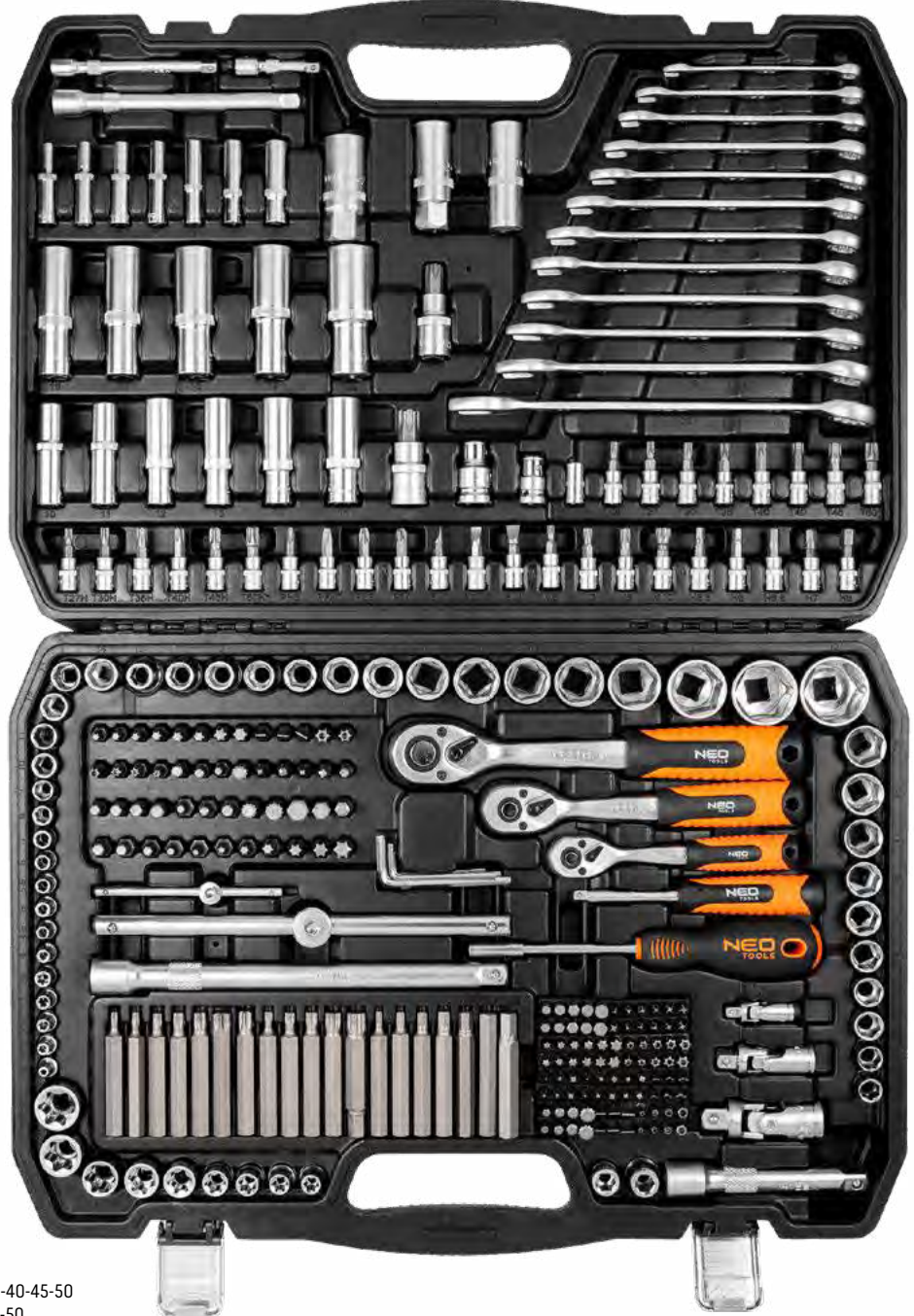

Ref.	⊞	EAN
10-218	1/4	5907558468892



Zestaw narzędzi

Tool and socket set / Werkzeugsatz / Набор инструментов / Инструмент з насадками, набір / Szerszámkészlet / Set scule de grădiniă / Sada nářadí / Súprava náradia kombi / Garnitura orodij / Įrankių komplektas / Instrumentu komplekts / Тоїристаде ја падруните комплект / Комплект инструменти / Set alata / Gedora set / Συλλογή εργαλείων / Juego de herramientas / Set di attrezzi / Kit de ferramentas / Jeu d'outils / Gereedschapsset

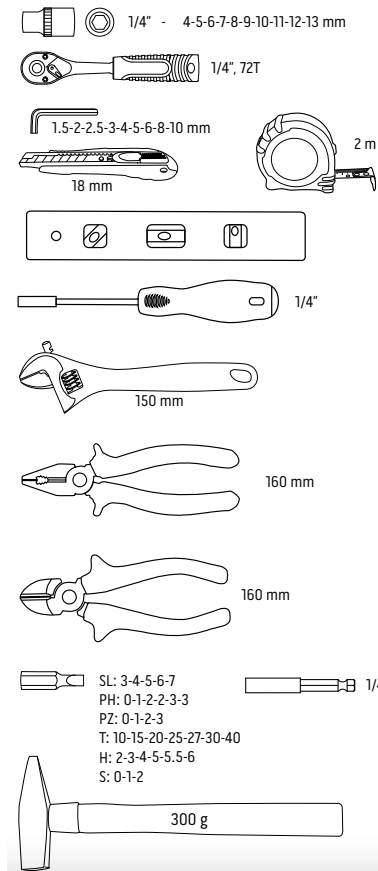

60
elements



Ref.	⊞	EAN
10-200	1/4	5907558463200

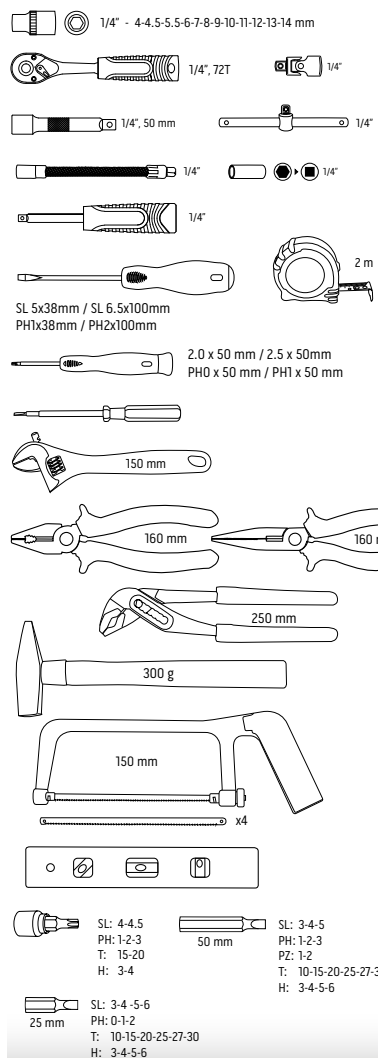

88
elements

Ref.	⊞	EAN
10-202	1/3	5907558463217



Zestaw narzędzi

Tool and socket set / Werkzeugsatz / Набор инструментов / Инструмент з насадками, набір / Szerszámkészlet / Set scule de grădină / Sada nářadí / Súprava náradia kombi / Garnitura orodij / Įrankių komplektas / Instrumentu komplekts / Тööriistade ja padrunite komplekt / Комплект инструменти / Set alata / Gedora set / Συλλογή εργαλείων / Juego de herramientas / Set di attrezzi / Kit de ferramentas / Jeu d'outils / Gereedschapsset

25 years GUARANTEE

CrV steel

STRONG CASE

ERGO

x122

1/4"

1/2"

72T 1/4"

72T 1/2"

1/4"

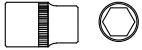

1/4": 4-4.5-5-5.5-6-7-8-9-10-11-12-13-14 mm
1/2": 12-13-14-15-16-17-18-19-20-21-22-24-27-30-32 mm

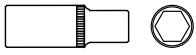

1/4": 4-5-6-7-8-9 mm
1/2": 10-12-13-14-17-19 mm



122 elements

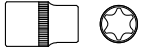

1/2": 10-12-14-16-18-20-22-24 mm



1/2" - 16, 21 mm

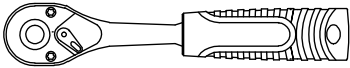

1/4", 72T, 155 mm
1/2", 72T, 255 mm

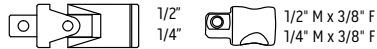

1/2" 1/2" M x 3/8" F
1/4" 1/4" M x 3/8" F

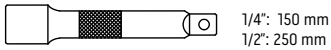

1/4": 150 mm
1/2": 250 mm

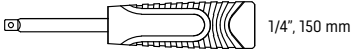

1/4", 150 mm

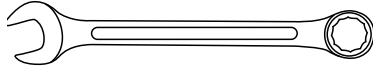

8-9-10-11-12-13-14-15-16-17-18-19 mm



180 mm

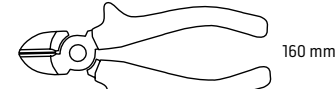

160 mm

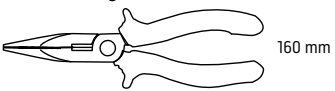

160 mm

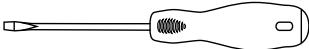

SL 4x100 mm / SL 6.5x100 mm
PH2x150 mm / PH3x150 mm

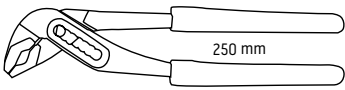

250 mm

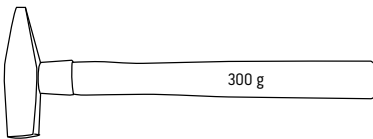

300 g

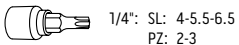

1/4": SL: 4-5.5-6.5
PZ: 2-3
PH: 2-3
H: 3-4-5-6
T: 8-10-15-20-25-27
TT: 10-15-20-25-40

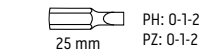

PH: 0-1-2
PZ: 0-1-2
SL: 3-4-5-6

1/4"

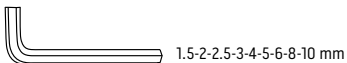

1.5-2-2.5-3-4-5-6-8-10 mm



Ref.	⊠	EAN
10-196	1/2	5907558468854



@NEOTOOLSOFFICIAL

@NEOTOOLS

NEOmov

neo-tools.com

59

Zestaw narzędzi

Tool and socket set / Werkzeugsatz / Набор инструментов / Инструмент з насадками, набір / Szerszámkészlet / Set scule de grădină / Sada nářadí / Súprava náradia kombi / Garnitura orodij / Įrankių komplektas / Instrumentu komplekts / Tööriistade ja padrunite komplekt / Комплект инструментов / Set alata / Gedora set / Συλλογή εργαλείων / Juego de herramientas / Set di attrezzi / Kit de ferramentas / Jeu d'outils / Gereedschapsset



100
elements



1/2" - 10-11-12-13-14-15-17-19-22-24-27-30-32 mm
1/4" - 4-5-6-7-8-9-10-11-12-13 mm

1/4" - 9-10-11-12-13 mm

1/2" - 16, 21 mm

1/2", 72T
1/4", 72T

1/2" - 125 mm

1/4" - 75 mm

1/2"
1/4" 1.5-2-2.5 mm

1/4"



8-10-11-12-13-14-15-17-19 mm

1/4" 1/4"



PZ 2x150 mm
SL 6.5x100 mm / SL 5.5x38 mm /
PH 2x100 mm / PH1x38 mm

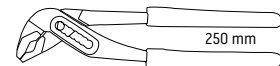

250 mm



180 mm

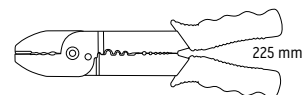

225 mm

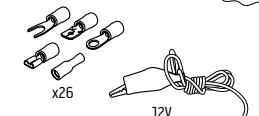

x26

12V

1/4" - TX - 15-20-30

PH - 1-2-3

SL - 4-5-5-7 mm

HEX - 3-4-5-6 mm

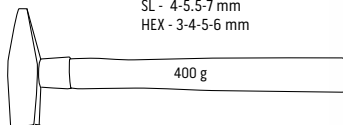

400 g



Ref.	⊞	EAN
08-920	1/2	5907558442137



Klucze nasadowe

Socket wrenches / Steckschlüssel / Набор сменных головок / Ключи торцевой / Dugókulcskészlet / Trusa tubulara / Nástrčné klúče / Nástrčné klúče / Nasadni ključ / Veržlerakció antgalai / Nomaināto galvu komplekts / Padrunvõrmed / Сменяемые наконечники за ключом / Nasadni ključevi / Ključevi natikači / Σει με καριδάκια / Laves de vaso / Set di bussola SuperLock / Chaves tubulares / Clefs à douilles / Dopsleutels

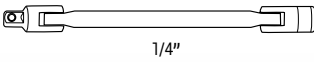
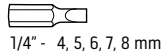
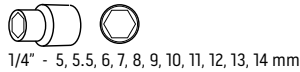

1/4" - 4, 5, 6, 7, 8 mm
PH1, PH2, PH3,
PZ1, PZ3, PZ2x2
TT8, TT9, TT10, TT15, TT20, TT25,
TT27, TT30, TT40
H2, H2.5, H3, H4, H5, H6, H7, H8

25 years
GUARANTEE



CrV
steel

S2
steel

x41

1/4"



Ref.	⊞	EAN
08-603	0/20	5907558409307



5 - 6 - 8 - 9 - 10 - 12 mm

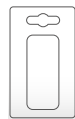

25 years
GUARANTEE



Ref.	⊞	EAN
09-570	6/24	5907558450453

Nasadka sześciokątna

Hexagonal socket / Sechskanteinsatz / Головка сменная шестигранная / Насадка шестигранная / Dugókulcs / Cheie tubulara hexagonala / Šestihranný nástavec / Šesthranný nástavec / Šestkotni natični nastavek / Šešiakampis antgalis / Sešstūra nomaināta galva / Kuuskantpadrun / Шестозъелна наставка / Šesterokutna kapica / Šestougaona nasadka / Καρυδάκι εξάγωνο / Vaso para destornillador hexagonal / Bussola esagonale / Bocal hexagonal / Douille à 6 pans / Zeskant dop

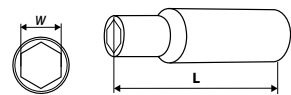

25 years
GUARANTEE

CrV
steel



1/4"



Ref.	W [mm]	L [mm]	⊞	EAN
08-487	4	50	25/200	5907558423679
08-488	4.5	50	25/200	5907558423686
08-489	5	50	25/200	5907558423693
08-490	5.5	50	25/200	5907558423709
08-491	6	50	25/200	5907558423716
08-492	7	50	25/200	5907558423723
08-493	8	50	25/200	5907558423730
08-494	9	50	25/200	5907558423747
08-495	10	50	25/200	5907558423754
08-497	12	50	15/150	5907558423778
08-498	13	50	15/150	5907558423785
08-499	14	50	15/150	5907558423792



Nasadka sześciokątna

Hexagonal socket / Sechskanteinsatz / Головка сменная шестигранная / Насадка шестигранная / Dugókulcs / Cheie tubulara hexagonala / Šestihranný nástavec / Šesthranný nástavec / Šestkotni natični nastavek / Šešiakampis antgalis / Sešstūra nomaināta galva / Kuuskantpadrun / Шестозъелна наставка / Šesterokutna kapica / Šestougaona nasadka / Καρυδάκι εξάγωνο / Vaso para destornillador hexagonal / Bussola esagonale / Bocal hexagonal / Douille à 6 pans / Zeskant dop

25 years
GUARANTEE



CrV
steel

1/4"



DIN
3124

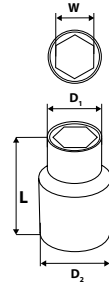

Ref.	W [mm]	L [mm]	D ₁ [mm]	D ₂ [mm]	⊞	EAN
08-220	4	25	7	12	100/500	5907558403787
08-221	4.5	25	7.5	12	100/500	5907558403794
08-222	5	25	8	12	25/200	5907558403800
08-223	5.5	25	8.5	12	25/200	5907558403817
08-224	6	25	9	12	100/200	5907558403824
08-225	7	25	10.5	12	25/200	5907558403831
08-226	8	25	12	12	25/200	5907558403848
08-227	9	25	13	13	50/500	5907558403855
08-228	10	25	14	14	25/200	5907558403862
08-229	11	25	16	16	50/500	5907558403879
08-230	12	25	17	17	15/150	5907558403886
08-231	13	25	18	18	15/150	5907558403893
08-232	14	25	20	20	50/500	5907558403909

25 years
GUARANTEE



CrV
steel

1/4"



DIN
3124

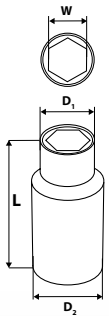

Ref.	W [mm]	L [mm]	D ₁ [mm]	D ₂ [mm]	⊞	EAN
08-235	4	50	7	12	50/500	5907558412055
08-236	4.5	50	7.5	12	50/500	5907558412062
08-237	5	50	8	12	50/500	5907558412079
08-238	5.5	50	8.5	12	50/500	5907558412086
08-239	6	50	9	12	50/500	5907558412093
08-240	7	50	10.5	12	25/200	5907558412109
08-241	8	50	12	12	50/200	5907558412116
08-242	9	50	13	13	50/200	5907558412123
08-243	10	50	14	14	25/200	5907558412130
08-244	11	50	16	16	50/150	5907558412147
08-245	12	50	17	17	50/300	5907558412154
08-246	13	50	18	18	50/150	5907558412161
08-247	14	50	20	20	50/150	5907558412178

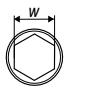

25 years
GUARANTEE

CrV
steel



1/4"

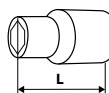

Ref.	W [mm]	L [mm]	⊞	EAN
08-442	4	25	25/200	5907558423280
08-443	4.5	25	25/200	5907558423297
08-444	5	25	25/200	5907558423303
08-446	6	25	25/200	5907558423327
08-447	7	25	25/200	5907558423334
08-448	8	25	25/200	5907558423341
08-449	9	25	25/200	5907558423358
08-450	10	25	25/200	5907558423365
08-451	11	25	15/150	5907558423372
08-452	12	25	15/150	5907558423389
08-453	13	25	15/150	5907558423396
08-454	14	25	15/150	5907558423402



Nasadka sześciokątna

Hexagonal socket / Sechskanteinsatz / Головка сменная шестигранная / Насадка шестигранна / Dugókulcs / Cheie tubulara hexagonală / Šestihránný nástavec / Šesthránný nástavec / Šestkotni natični nastavek / Šešakampis antgalis / Sešstūra nomaināmā galva / Kuuskantpradrin / Шестъгълна наставка / Šesterokutna kapica / Šestougaona nasadka / Καρυδάκι εξαγώνο / Vaso para destornillador hexagonal / Bussola esagonale / Bocal hexagonal / Douille à 6 pans / Zeskant dop

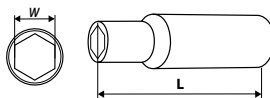
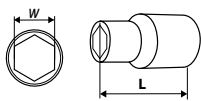

Ref.	W [mm]	L [mm]	☒	EAN
08-168	8	30	20/200	5907558422757
08-170	10	30	20/200	5907558422764
08-171	11	30	20/200	5907558422771
08-172	12	30	20/200	5907558422788
08-173	13	30	20/200	5907558422795
08-174	14	30	20/200	5907558422801
08-175	15	30	20/200	5907558422818
08-176	16	30	20/200	5907558422825
08-177	17	30	20/200	5907558422832
08-178	18	30	20/200	5907558422849
08-179	19	30	20/200	5907558422856
08-180	20	30	20/200	5907558422863
08-181	21	30	20/200	5907558422870
08-182	22	30	20/200	5907558422887

Ref.	W [mm]	L [mm]	☒	EAN
08-184	8	63	20/200	5907558422894
08-185	10	63	20/200	5907558422900
08-186	11	63	20/200	5907558422917
08-187	12	63	20/200	5907558422924
08-188	13	63	20/200	5907558422931
08-189	14	63	20/200	5907558422948
08-190	15	63	20/200	5907558422955
08-191	16	63	20/200	5907558422962
08-192	17	63	20/200	5907558422979
08-193	18	63	20/200	5907558422986
08-194	19	63	20/200	5907558422993
08-195	20	63	20/100	5907558423006
08-196	21	63	20/100	5907558423013
08-197	22	63	20/100	5907558423020

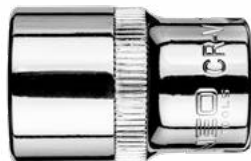
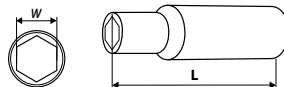
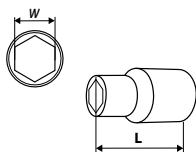

Ref.	W [mm]	L [mm]	☒	EAN
08-408	8	38	20/200	5907558423037
08-409	9	38	20/200	5907558423044
08-410	10	38	20/200	5907558423051
08-411	11	38	20/200	5907558423068
08-412	12	38	20/200	5907558423075
08-413	13	38	20/200	5907558423082
08-414	14	38	20/200	5907558423099
08-415	15	38	20/200	5907558423105
08-416	16	38	20/200	5907558423112
08-417	17	38	20/200	5907558423129
08-418	18	38	20/200	5907558423136
08-419	19	38	20/200	5907558423143
08-421	21	38	20/200	5907558423167
08-422	22	38	20/200	5907558423174
08-423	23	38	20/200	5907558423181
08-424	24	38	20/200	5907558423198
08-425	25	38	10/100	5907558423204
08-426	26	42	10/100	5907558423211
08-427	27	42	10/100	5907558423228
08-429	29	44	10/100	5907558423242
08-430	30	44	10/100	5907558423259
08-431	31	44	10/100	5907558423266
08-432	32	44	10/100	5907558423273

Ref.	W [mm]	L [mm]	☒	EAN
08-458	8	77	20/200	5907558423419
08-459	9	77	20/200	5907558423426
08-460	10	77	20/200	5907558423433
08-461	11	77	20/200	5907558423440
08-462	12	77	20/200	5907558423457
08-463	13	77	20/200	5907558423464
08-464	14	77	20/200	5907558423471
08-465	15	77	20/200	5907558423488
08-466	16	77	20/200	5907558423495
08-467	17	77	20/200	5907558423501
08-468	18	77	20/200	5907558423518
08-469	19	77	20/200	5907558423525
08-470	20	77	20/100	5907558423532
08-471	21	77	20/100	5907558423549
08-472	22	77	20/100	5907558423556
08-473	23	77	20/100	5907558423563
08-474	24	77	20/100	5907558423570
08-475	25	77	10/50	5907558423587
08-476	26	77	10/50	5907558423594
08-477	27	77	10/50	5907558423600
08-478	28	77	10/50	5907558423617
08-479	29	77	10/50	5907558423624
08-480	30	77	10/50	5907558423631
08-482	32	77	10/50	5907558423655
08-486	36	77	4/40	5907558423662



Nasadka sześciokątna

Hexagonal socket / Sechskanteinsatz / Головка сменная шестигранная / Насадка шестигранная / Dugókulcs / Cheie tubulara hexagonala / Šestihranný nástavec / Šesthranný nástavec / Šestkotni natični nastavec / Sešiakampis antgalis / Sešstūra nomaināmā galva / Kuuskantpadrun / Шестьугольная насадка / Šesterokutna kapica / Šestougaona nasadka / Καρυβάκι εξήγωνα / Vaso para destornillador hexagonal / Bussola esagonale / Bocal hexagonal / Douille à 6 pans / Zeskant dop

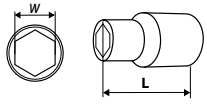

25 years
GUARANTEE



CrV
steel

1/2"



DIN
3124



Ref.	W [mm]	L [mm]	☒	EAN
08-008	8	38	20/200	5907558403503
08-009	9	38	20/200	5907558403510
08-010	10	38	20/100	5907558402353
08-011	11	38	20/100	5907558403527
08-012	12	38	20/100	5907558402360
08-013	13	38	20/200	5907558402377
08-014	14	38	20/100	5907558408232
08-015	15	38	20/200	5907558402384
08-016	16	38	20/200	5907558403534
08-017	17	38	20/200	5907558402391
08-018	18	38	20/200	5907558403541
08-019	19	38	20/200	5907558402407
08-020	20	38	10/100	5907558412451
08-021	21	38	20/200	5907558403558
08-022	22	38	20/200	5907558402414
08-023	23	38	10/100	5907558412468
08-024	24	38	20/100	5907558402421
08-025	25	38	10/100	5907558412475
08-026	26	42	10/100	5907558403565
08-027	27	42	10/100	5907558402438
08-028	28	42	10/100	5907558403572
08-029	29	44	10/100	5907558403589
08-030	30	44	10/100	5907558402445
08-032	32	44	10/100	5907558402452
08-036	36	44	10/0	5907558403602

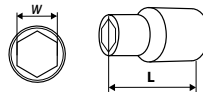

25 years
GUARANTEE



CrV
steel

3/4"



DIN
3124



Ref.	W [mm]	L [mm]	☒	EAN
08-300	19	51	10/80	5907558404180
08-301	21	51	10/100	5907558410600
08-302	22	51	10/80	5907558404197
08-304	24	51	10/100	5907558404203
08-306	27	52	10/80	5907558404210
08-307	28	52	10/60	5907558412543
08-308	30	54	10/60	5907558404227
08-309	32	56	10/60	5907558404234
08-316	34	56	10/60	5907558410624
08-319	35	57	10/60	5907558412567
08-311	36	59	10/40	5907558404241
08-312	38	60	10/40	5907558404258
08-313	41	64	10/40	5907558404265
08-314	46	68	10/20	5907558404272
08-315	50	72	10/20	5907558404289
08-340	55	76	10/20	5907558412574
08-341	60	78	10/20	5907558412581



Nasadka dwunastokątna

Bi-hexagonal socket / Zwölfkanteinsatz / Головка сменная двенадцатигранная / Насадка двенадцатигранная / Dugókulcs 12 pontos / Cheie tubulara, priza in 12 pute / Dvanástihranný nástavec / Dvanástkotni nasadni ključ / Dvylikakampis antgalis / Divpadsmištūra nomaināmā galva / Kaksteistkantpadrun / Дванадесетьугольная насадка / Dvanaesterokutna kapica / Dvanaestougaona nasadka / Καρυβάκι δωδεκάγωνα / Vaso destornillador de encaje dodecagonal / Bussola Spline / Bocal de doze ângulos / Douille à 12 pans / Twaalfkant dop

25 years
GUARANTEE



CrV
steel

1/2"



DIN
3124

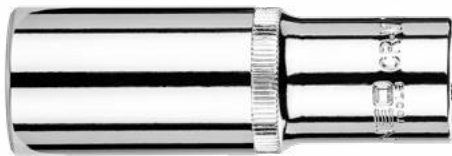
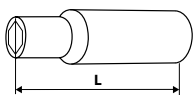

Ref.	W [mm]	L [mm]	☒	EAN
08-039	8	77	12/144	5907558410501
08-040	9	77	20/200	5907558410518
08-041	10	77	20/200	5907558402469
08-052	11	77	20/176	5907558410525
08-042	12	77	20/200	5907558402476
08-043	13	77	20/200	5907558402483
08-053	14	77	20/176	5907558410532
08-044	15	77	20/200	5907558402490
08-054	16	77	12/144	5907558410549
08-045	17	77	20/200	5907558402506
08-055	18	77	20/96	5907558410556
08-046	19	77	20/200	5907558402513
08-056	21	77	6/96	5907558410563
08-047	22	77	6/96	5907558402520
08-058	23	77	6/72	5907558412499
08-048	24	77	6/72	5907558402537
08-049	27	77	10/100	5907558402544
08-050	30	77	10/50	5907558402551
08-051	32	77	6/48	5907558402568

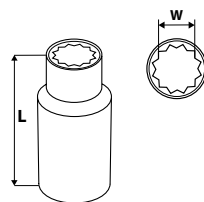

25 years
GUARANTEE



CrV
steel

1/2"



DIN
3124



Ref.	W [mm]	L [mm]	☒	EAN
08-070	10	77	8/200	5907558405613
08-086	11	77	12/144	5907558410594
08-071	12	77	20/200	5907558405620
08-072	13	77	12/200	5907558405637
08-073	14	77	20/200	5907558408249
08-074	15	77	12/144	5907558405644
08-075	16	77	20/200	5907558406078
08-076	17	77	20/200	5907558405651
08-077	18	77	6/96	5907558406085
08-078	19	77	6/96	5907558405668
08-080	21	77	6/96	5907558408256
08-081	22	77	6/120	5907558405675
08-082	24	77	6/72	5907558405682
08-083	27	77	6/72	5907558405699
08-084	30	77	10/50	5907558405705
08-085	32	77	6/948	5907558405712



Nasadka dwunastokątna

Bi-hexagonal socket / Zwölfkanteinsatz / Головка сменная двенадцатигранная / Насадка двенадцатигранная / Dugökülcs 12 pontos / Cheie tubulara, priza in 12 pute / Dvanáctihřanný nástavec / Dvanáštřhanný nástavec / Dvanajstkotni nasadni ključ / Dvylkakampis antgalis / Divpadsmitšūra notaināmā galva / Kaksteistkantpadrūn / Дванадцетъгълна наставка / Dvanaesterokutna kapica / Dvanaestougaona nasadka / Карубіа дьвонадцятъгълна / Vaso destornillador de encaje dodecagonal / Bussola Spline / Bocal de doze ângulos / Douille à 12 pans / Twaalfkant dop

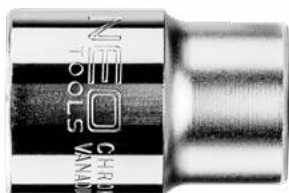
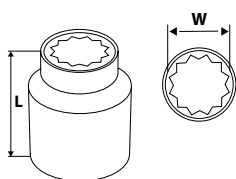

Ref.	W [mm]	L[mm]	⊠	EAN
08-320	19	50	10/80	5907558406108
08-333	21	52	10/80	5907558410631
08-321	22	50	10/80	5907558406115
08-322	24	51	10/80	5907558406122
08-323	27	52	10/80	5907558406139
08-324	30	54	10/60	5907558406146
08-325	32	56	10/60	5907558406153
08-335	34	56	10/60	5907558410655
08-326	36	58	10/60	5907558406160
08-327	38	60	10/40	5907558406177
08-328	41	64	10/40	5907558406184
08-329	46	68	10/20	5907558406191
08-331	55	76	10/20	5907558406214
08-332	60	79	10/20	5907558406221

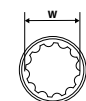

MM	10	12	13	15	17	19	22	24
INCH	3/8	15/32	1/2	19/32		3/4	7/8	15/16
STAR	E12	E16				E24		

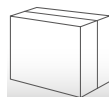

Ref.	W [mm]	⊠	EAN
08-651	10,12,13,15,17,19,22,24	0/30	5907558406290



Ref.	W [mm]	L[mm]	⊠	EAN
08-580	8	38	10/200	5907558408263
08-581	9	38	10/100	5907558408270
08-582	10	38	20/100	5907558408287
08-583	11	38	10/100	5907558408294
08-584	12	38	10/100	5907558408300
08-585	13	38	10/200	5907558408317
08-586	14	38	10/200	5907558408324
08-587	15	38	10/100	5907558408331
08-588	16	38	10/200	5907558408348
08-589	17	38	10/200	5907558408355
08-590	18	38	10/200	5907558408362
08-591	19	38	10/100	5907558408379
08-592	20	38	10/100	5907558408386
08-593	21	38	10/100	5907558408393
08-594	22	38	10/100	5907558408409
08-595	23	38	10/100	5907558412505
08-596	24	38	10/200	5907558408416
08-597	27	42	10/100	5907558408423
08-598	30	44	10/100	5907558408430
08-599	32	44	10/100	5907558408447

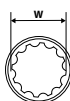

MM	10	12	13	15	17	19	22	24
INCH	3/8	15/32	1/2	19/32		3/4	7/8	15/16
STAR	E12	E16				E24		

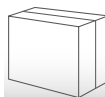

Ref.	W [mm]	m[kg]	⊠	EAN
08-650	10,12,13,15,17,19,22,24	1,1	0/20	5907558406283

Grzechotka

Ratchet handle / Ratsche / Трещотка / Держак з трісноткою / Racsnikulcs / Miner de hurluitoare / Рѣнтачка / Račňa prepinacia / Raglja / Terkslė / Reversa atslėga / Põrktratta pide / Трещотка / Račva za nasadni ključ / Račva za geduru / Καατανά / Llave de carraca / Cricchetto / Catraca de furar / Clé à cliquet / Roteel

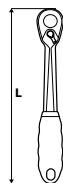

Ref.	Info	L[mm]	⊠	EAN
10-300	1/2"	285	1/10	5907558467338



Ref.	Info	L[mm]	⊠	EAN
08-530	1/4"	155	10/50	5907558435689
08-533	3/8"	200	5/25	5907558435696
08-536	1/2"	250	5/20	5907558435702



Grzechotka

Ratchet handle / Ratsche / Трещотка / Держак з тріскоткою / Racsnikulcs / Mîner de hurluitoare / Řehtačka / Račna prepínacia / Raglja / Terkslê / Reversa atslêga / Põrkkratta pide / Трещотка / Račva za nasadni ključ / Račva za gedoru / Κατασπία / Llave de carraca / Cricchetto / Catraca de furar / Clé à cliquet / Rate!



25 years GUARANTEE
TUV Rheinland CERTIFIED
CrV steel
CrMo steel
72
DIN 3122

Ref.	Info	L[mm]	⊠	EAN
08-540	1/4"	155	5/50	5907558435719
08-543	3/8"	200	5/25	5907558435726
08-546	1/2"	250	5/20	5907558435733



25 years GUARANTEE
TUV Rheinland CERTIFIED
CrV steel
48
DIN 3122

Ref.	Info	L[mm]	⊠	EAN
08-504	1/4"	150	10/50	5907558420708
08-508	3/8"	210	6/48	5907558420715
08-521	1/2"	265	5/25	5907558420722



25 years GUARANTEE
CrV steel
45
DIN 3122

Ref.	Info	L[mm]	⊠	EAN
08-523	1/4"	155	6/72	5907558432190
08-524	3/8"	200	6/48	5907558432206
08-525	1/2"	250	6/36	5907558432213



25 years GUARANTEE
TUV Rheinland CERTIFIED
CrV steel
CrMo steel
72
DIN 3122

Ref.	Info	Lmin[mm]	Lmax[mm]	⊠	EAN
08-502	1/4"	150	200	10/50	5907558412802
08-515	1/2"	305	445	0/25	5907558408546



25 years GUARANTEE
TUV Rheinland CERTIFIED
CrV steel
CrMo steel
72
1/2" DIN 3122

Ref.	Info	L[mm]	⊠	EAN
08-519	1/2"	285	0/24	5907558410167



25 years GUARANTEE
TUV Rheinland CERTIFIED
CrV steel
CrMo steel
72
DIN 3122

Ref.	Info	L[mm]	⊠	EAN
08-503	1/4"	145	10/50	5907558412819
08-507	3/8"	195	5/60	5907558412833
08-520	1/2"	255	5/25	5907558412840



25 years GUARANTEE
TUV Rheinland CERTIFIED
CrV steel
CrMo steel
72
PP POLYPROPYLEN
DIN 3122

Ref.	Info	L[mm]	⊠	EAN
08-514	1/4"	150	12/72	5907558406276
08-513	3/8"	200	12/48	5907558406269
08-511	1/2"	250	0/24	5907558402605



25 years GUARANTEE
TUV Rheinland CERTIFIED
CrV steel
48
1/2" DIN 3122

Ref.	Info	L[mm]	⊠	EAN
08-516	1/2"	255	6/24	5907558409291



25 years GUARANTEE
TUV Rheinland CERTIFIED
CrV steel
CrMo steel
24
3/4" DIN 3122

Ref.	Info	L[mm]	⊠	EAN
08-355	3/4"	500	0/16	5907558404449



25 years GUARANTEE
TUV Rheinland CERTIFIED
CrV steel
CrMo steel
48
1/4" 72
DIN 3122

Ref.	Info	L[mm]	⊠	EAN
08-512	1/4"	105	10/60	5907558403305



25 years GUARANTEE
TUV Rheinland CERTIFIED
CrV steel
CrMo steel
1/4" 72
DIN 3122

Ref.	Info	L[mm]	⊠	EAN
08-501	1/4"	105	10/100	5907558412185



Pokręto

Wheel / Drehknopf / Вороток / Маховик / Hajtókár / Clupá / Otočný knoflík / Ovládacie koliesko / Raglja / Rankena / Grietzuvite / Nurr / Върток / Kота́чи / Ručica / Пóмолo / Mango / Impugnatura a L / Botão / Tourne-à-gauche / Драаикноп

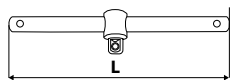

25
years
GUARANTEE



CrV
steel

DIN
3122



Ref.	Info	L[mm]	☒	EAN
08-256	1/4"	110	20/200	5907558403961
08-155	3/8"	165	20/100	5907558403770
08-555	1/2"	250	5/25	5907558402650
08-353	3/4"	460	10/10	5907558404425



25
years
GUARANTEE



CrV
steel



Ref.	Info	L[mm]	L ₁ [mm]	☒	EAN
08-556	1/2"	250	75	0/40	5907558408607
08-357	3/4"	450	110	0/10	5907558405873

Przedłużka

Extension bar / Verlängerung / Удлинитель / Подовжувач / Toldósár / Prelungitor / Prodlužovák / Predĺženie / Podaljšek / Ilgiklis / Pagarinātājs / Piekendsvarras / Удължител / Produziena poluga / Προέκταση / Alargadera / Prolunga / Extensão / Prolongation / Verlengstuk

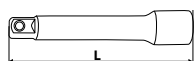

25
years
GUARANTEE



CrV
steel

DIN
3123



Ref.	L[mm]	Info	☒	EAN
08-251	50	1/4"	20/200	5907558403916
08-252	75	1/4"	20/200	5907558403923
08-253	100	1/4"	25/50	5907558403930
08-254	150	1/4"	25/50	5907558403947
08-151	75	3/8"	20/200	5907558403732
08-152	125	3/8"	20/200	5907558403749
08-153	150	3/8"	20/100	5907558403756
08-552	125	1/2"	10/50	5907558402636
08-554	250	1/2"	10/50	5907558402643
08-350	100	3/4"	10/40	5907558404296
08-351	200	3/4"	10/20	5907558404302
08-352	400	3/4"	0/10	5907558404418

Przedłużka elastyczna
Flexible extension
Удлинитель гибкий

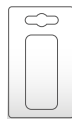
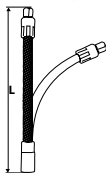

Ref.	☐	L[mm]	M _{0max} [Nm]	☒	EAN
08-557	1/4"	140	5	25/100	5907558402667
08-558	1/2"	190	40	10/80	5907558402674



CrV
steel

Rękojeść z przegubem

Flex handle / Handgriff mit Gelenk / Вороток / Рукюя з шарніром / Hajtókár flexibilis / Maner cu articulație / Kloubové vratidlo / Klbová rukoväť / Ročaj z zglobom / Rankena su lankstu / Pagarinātājs mucinātslēgai / Liigidiga käepide / Ръкохватка с шарнир / Drška sa zglobom / Drška sa zglobom / Μανέλα αλυσθαινούσα / Mango con articulación / Impugnatura telescopica / Cabo com Articulação / Poignée articulée / Handvat met spilverbinding

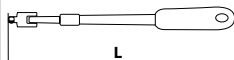

25
years
GUARANTEE



CrV
steel

1/2"

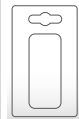

Ref.	L _{min} [mm]	L _{max} [mm]	☒	EAN
08-553	470	620	5/20	5907558409598

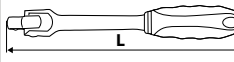

25
years
GUARANTEE



CrV
steel

1/2"



Ref.	L[mm]	☒	EAN
08-559	250	10/40	5907558403367
08-560	450	10/20	5907558403374

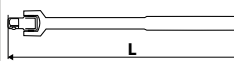

25
years
GUARANTEE



CrV
steel

3/4"

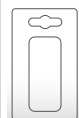

Ref.	L[mm]	☒	EAN
08-356	510	0/10	5907558404456

Przegub

Articulated joint / Gelenk / Шарнир / Сустав / Kardáncsukló / Articulație / Kloub / Čap / Zglob / Lankstas / Šarnirs / Klamber / Шарнир / Zglob / Zglob / Μεντεός / Articulación / Giunto articolato / Articulação / Articulation / Spilverbinding

25
years
GUARANTEE



CrV
steel

DIN
3123

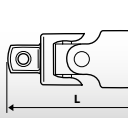

Ref.	Info	L[mm]	☒	EAN
08-255	1/4"	35	50/400	5907558403954
08-154	3/8"	50	50/400	5907558403763
08-551	1/2"	65	10/80	5907558402629

Redukcja / Adapter

Adaptor / Reduzierstück / Переходник / Перехідник / Adapter / Adaptor / Redukce / Redukcia / Adapter / Adapteris / Pāreja / Адаптор / Adapter / Προσαρμογέας / Adaptador / Adattatore / Redução / Réduction / Reductiestuk

25
years
GUARANTEE



CrV
steel

DIN
3123

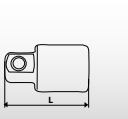

Ref.	Info	L[mm]	☒	EAN
08-562	1/4" M x 3/8" F	26	10/100	5907558403329
08-563	3/8" M x 1/2" F	37	10/100	5907558403336
08-565	1/2" M x 3/4" F	50	40/40	5907558403350
08-564	3/4" M x 1/2" F	46	10/100	5907558403343
08-550	1/2" M x 3/8" F	27	25/200	5907558402612



Końcówka Spline na nasadce

Spline bit / Spline-Endstück / Наконечник Spline / Наконечник „Spline” / Spline bit / Punct Spline / Nástavec Spline / Nástavec Spline / Nástavec Spline / Antgalis Spline / Uzgalis Spline / Spline-otsak / Накрайник Spline / Nastavak Spline / Nastavak Spline / Μύτη Spline / Punta Spline / Inserto Spline su bussola / Ponteiro Spline / Embout Spline / Spline eindstuk



Ref.	Info	L[mm]	⊠	EAN
08-730	M5	55	12/144	5907558411911
08-731	M6	55	12/144	5907558411928
08-732	M8	55	12/144	5907558411935
08-733	M10	55	12/144	5907558411942
08-734	M12	55	12/160	5907558411959
08-735	M14	55	12/160	5907558411966
08-736	M16	55	12/144	5907558411973

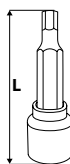

Ref.	Info	L[mm]	⊠	EAN
08-740	M5	100	12/96	5907558411980
08-741	M6	100	12/96	5907558411997
08-742	M8	100	12/96	5907558412000
08-743	M10	100	12/96	5907558412017
08-744	M12	100	12/96	5907558412024
08-745	M14	100	12/96	5907558412031
08-746	M16	100	12/96	5907558412048



Końcówka na nasadce

Bit on socket / Einsatz auf Aufsatz / Головка сменная с насадкой / Наконечник на насадку / Bit / Cap tubulara cu antrenor / Koncovka na nástavce / Koncovka na nástavce / Nástavec za nasadni ključ / Torcinis antgalis su laikikliu / Nomainātmā galva ar uzgali / Otsak padrunil / Накрайник на наставката / Nastavak na kapici / Nastavak za nasadke / Καρυδάκι με μύτη / Vaso / Inserto con bussola / Ponteiros no bico / Embouts sur ajutage / Eindstuk op dop



Ref.	Info	L[mm]	⊠	EAN
10-316	PH1	37	20/200	5907558471243
10-317	PH2	37	20/200	5907558471250
10-318	PH3	37	20/200	5907558471267
10-319	PZ1	37	20/200	5907558471274
10-320	PZ2	37	20/200	5907558471281
10-321	PZ3	37	20/200	5907558471298

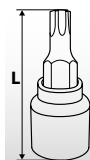

Ref.	Info	L[mm]	⊠	EAN
10-334	PH1	87	30/300	5907558471427
10-335	PH2	87	30/300	5907558471434
10-336	PH3	87	30/300	5907558471441
10-337	PZ1	87	30/300	5907558471458
10-338	PZ2	87	30/300	5907558471465
10-339	PZ3	87	30/300	5907558471472

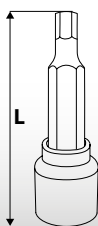

Końcówki sześciokątne na nasadce

Hexagonal bits on socket / Sechskanteinsätze auf Aufsatz / Головки шестигранные с насадкой / Наконечники шестигранные на насадку / Imbusz bit / Trusa capete tubulare cu antrenor / Koncovky šestihranné na nástavce / Šestihranné koncovky na nástavce / Šestkotni nastavki za nasadni ključ / Šešiakantpiai antgaliai su laikikliu / Nomainātmā galva ar sešstūra uzgaliem / Kuuskantotsakud padrunil / Шестогълни накрайници на наставката / Šesterokutni nastavci na kapici / Šestougoni nastavci za nasadke / Καρυδάκι με μύτες εξαγώνες / Vasos destormilladores hexagonales / Inserto esagonale con bussola / Ponteiros hexagonais na bico / Embouts à 6 pans sur ajutage / Zeskant eindstukken op dop



Ref.	Info	L[mm]	⊠	EAN
10-310	H3	37	20/200	5907558471182
10-311	H4	37	20/200	5907558471199
10-312	H5	37	20/200	5907558471205
10-313	H6	37	20/200	5907558471212
10-314	H7	37	20/200	5907558471229
10-315	H8	37	20/200	5907558471236

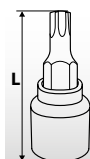

Ref.	Info	L[mm]	⊠	EAN
10-329	H4	87	30/300	5907558471373
10-330	H5	87	30/300	5907558471380
10-331	H6	87	30/300	5907558471397
10-332	H7	87	30/300	5907558471403
10-333	H8	87	30/300	5907558471410

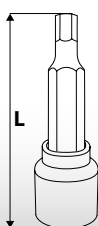

Ref.	Info	L[mm]	⊠	EAN
08-770	H5	55	20/140	5907558409765
08-771	H6	55	12/144	5907558409772
08-772	H7	55	20/160	5907558409789
08-773	H8	55	12/144	5907558409796
08-774	H10	55	20/160	5907558409802
08-775	H12	55	20/160	5907558409819
08-776	H14	55	20/160	5907558409826
08-777	H17	55	20/160	5907558409833
08-778	H19	55	12/96	5907558409840



Ref.	Info	L[mm]	⊠	EAN
08-780	H5	100	12/96	5907558409857
08-781	H6	100	20/100	5907558409864
08-782	H7	100	12/96	5907558409871
08-783	H8	100	20/100	5907558409888
08-784	H10	100	20/100	5907558409895

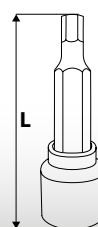

Końcówki sześciokątne na nasadce

Hexagonal bits on socket / Sechskanteinsätze auf Aufsatz / Головки шестигранные с насадкой / Наконечники шестигранны на насадці / Imbusz bit / Trusa capete tubulare cu antrenor / Koncovky šestihranné na nástavce / Šesthranné koncovky na nástavce / Šestkotni nastavki za nasadni ključ / Šešiakampriai antgaliai su laikikliu / Normainānā galva ar sešstūra uzgaļiem / Kuuskantotsakud padrunil / Шестоъгълни накрайници на наставката / Šesterokutni nastavci na kapici / Šestougaoni nastavci za nasadke / Καρυδάκι με μύτες εξάγωνες / Vasos destornilladores hexagonales / Inserto esagonal con bussola / Ponteiros hexagonais no bico / Embouts à 6 pans sur ajutage / Zeskant eindstukken op dop

H4, H5, H6, H7, H8, H10, H12, H14, H17

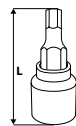

Ref.	L[mm]	☒	EAN
08-705	55	0/12	5907558409253



H4, H5, H6, H7, H8, H10, H12, H14, H17

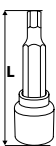

Ref.	L[mm]	☒	EAN
08-706	100	0/12	5907558409260



Końcówki Torx na nasadce

Torx bit on socket / Torx-Einsatz auf Aufsatz / Головка сменная с насадкой Torx / Наконечник «Торх» на насадці / Torx bit / Cap tubulara cu antrenor torx / Koncovka Torx na nástavce / Koncovka Torx na nástavce / Nastavek Torx za nasadni ključ / Torcinis antgalis su laikikliu / Normainānā galva ar Torx uzgali / Torx-otsak padrunil / Накрайник Torx на наставката / Nastavak Torx na kapici / Nastavak Torx za nasadke / Καρυδάκι με μίτη Torx / Vaso torx / Inserto Torx con bussola / Ponteiros Torx no bico / Embouts Torx sur ajutage / Trox eindstuk op dop

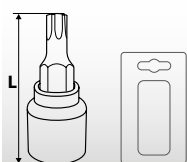

Ref.	Info	L[mm]	☒	EAN
10-322	T10	37	20/200	5907558471304
10-323	T15	37	20/200	5907558471311
10-324	T20	37	20/200	5907558471328
10-325	T25	37	20/200	5907558471335
10-326	T27	37	20/200	5907558471342
10-327	T30	37	20/200	5907558471359
10-328	T40	37	20/200	5907558471366

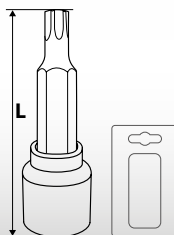

Ref.	Info	L[mm]	☒	EAN
10-340	T10	87	30/300	5907558471489
10-341	T15	87	30/300	5907558471496
10-342	T20	87	30/300	5907558471502
10-343	T25	87	30/300	5907558471519
10-344	T27	87	30/300	5907558471526
10-345	T30	87	30/300	5907558471533
10-346	T40	87	30/300	5907558471540

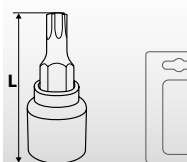

Ref.	Info	L[mm]	☒	EAN
08-750	T20	55	12/144	5907558409604
08-751	T25	55	12/144	5907558409611
08-752	T27	55	12/144	5907558409628
08-753	T30	55	12/144	5907558409635
08-754	T40	55	20/160	5907558409642
08-755	T45	55	20/160	5907558409659
08-756	T50	55	12/144	5907558409666
08-757	T55	55	20/160	5907558409673
08-758	T60	55	12/144	5907558417388
08-759	T70	55	12/144	5907558417395

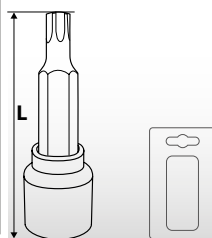

Ref.	Info	L[mm]	☒	EAN
08-760	T20	100	12/96	5907558409680
08-761	T25	100	20/100	5907558409697
08-762	T27	100	20/100	5907558409703
08-763	T30	100	20/100	5907558409710
08-764	T40	100	12/96	5907558409727
08-765	T45	100	20/100	5907558409734
08-766	T50	100	20/100	5907558409741
08-767	T55	100	20/100	5907558409758



Końcówki Torx na nasadce

Torx bit on socket / Torx-Einsatz auf Aufsatz / Головка сменная с насадкой Torx / Наконечник «Torx» на насадке / Torx bit / Cap tubulara cu antrenor torx / Koncovka Torx na nástavce / Koncovka Torx na nástavce / Nastavek Torx za nasadni ključ / Torcinis antgališ su laikikliu / Nomaināma galva ar Torx uzgali / Torx-otsak padrunil / Накрайник Torx на наставката / Nastavak Torx na kapici / Nastavak Torx za nasadke / Καρυδάκι με μύτη Torx / Vaso torx / Inserto Torx con bussola / Ponteiros Torx no bico / Embouts Torx sur ajutage / Trox eindstuk op dop

 T20, T25, T27, T30, T40, T45, T50, T55, T60



25 years
GUARANTEE



S2
steel

1/2"

CrV
steel

x9

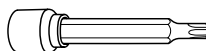

H6, H7, H8, H10, H12
T25, T30, T40, T45, T50, T60
M6, M8, M10, M12, M14

T20, T25, T27, T30, T40, T45, T50, T60

S2
steel

x49

CrV
steel



1/2"

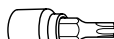

H5, H6, H7, H8, H10, H12, H14, H17, H19
T20, T25, T27, T30, T40, T45, T50, T55, T60, T70
M5, M6, M8, M10

Ref.	L[mm]	☒	EAN
08-707	55	0/12	5907558409277

 T20, T25, T27, T30, T40, T45, T50, T55, T60

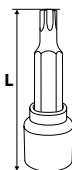

25 years
GUARANTEE



S2
steel

1/2"

CrV
steel

x9



Ref.	L[mm]	☒	EAN
08-708	100	0/12	5907558409284

Ref.	☒	EAN
08-713	0/3	5907558420180

Końcówki i nasadki torx

Torx bits and socket set / Torx-Aufsätze / Наконечники и головки торцевые Torx / Набор жезла та насадок «torx» / Torx kulcskészlet / Set canule "torx" și fixări / Bity a nástavce Torx / Súprava klúčov torx / Garnitura nastavkov z vpenjalom / Antgališ Torx ir galviš rinkinys / Torx atslėgu un tūsiņu komplekts / "Torx" atsikute ja padrunite komplekt / Вложки и накрайници / Set Nasadnih ključeva I biceva / Set biceva I gedora / Συλλογή από μύτες και καρυδάκια / Puntas destornilladoras y vasos TORX / Inserti Torx / Ponteiros e Bocais Torx / Embouts et douilles Torx / Torx eindstukken en doppen



E4, E5, E6, E7, E8, E10, E11, E12, E14, E16, E18, E20
T10, T15, T20, T25, T27, T30, T40, T45, T50, T55, T60
TT10, TT15, TT20, TT25, TT27, TT30, TT40, TT45, TT50, TT55



CrV
steel

3/8"



S2
steel

x34





Ref.	☒	EAN
08-711	0/12	5907558417111



Nasadki Torx

Torx sockets / Torx-Aufsätze / Головки сменные Torx / Насадки «Torx» / Torx kulcs / Tubulara cu capat torx / Nástavce Torx / Nástavce Torx / Nasadni ključiči Torx / Torciniai antgaliai / Torx nomaināmas galviņas / Torx-padrūnīd / Насадки Torx / Каріце Torx / Nasadke Torx / Ανταλλακτικές μύτες Torx / Vasos torx / Bussole Torx / Bocais Torx / Douilles Torx / Torx doppen

  E10, E11, E12, E14, E16, E18, E20, E22, E24

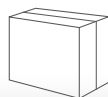

Ref.		EAN
08-649	0/15	5907558417074



Końcówki wkrętaskowe



Driver bits / Einsätze für Schraubendreher / Насадки / Наконечники викртові / Dugókulcs bitkészlet / Set biti / Šroubovákové nástavce / Skrutkovacie nástavce / Nastavki za izvijače / Atsuktuvo antgaliai / Skrūvgrieža uzgaļi / Kruvikeerajaotsakud / Накрайници за отвёртка / Nastavci za odvijajč / Nastavci za odvijajč / Καταβιδόμυτες / Puntas destornilladoras / Inserti lunghi e corti / Ponteiros Chave de fenda / Embouts de tournevis / Schroevendraaiereindstukken

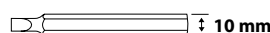

 $\pm 10 \text{ mm}$
L 30 mm

 $\pm 10 \text{ mm}$
L 75 mm

-  30 mm: T20, T25, T30, T40, T45, T50, T55
75 mm: T20, T25, T30, T40, T45, T50, T55
-  30 mm: H4, H5, H6, H7, H8, H10, H12
75 mm: H4, H5, H6, H7, H8, H10, H12
-  30 mm: M5, 6, 8, 10, 12
75 mm: M5, 6, 8, 10, 12

  
3/8" > 10 mm
1/2" > 10 mm



Ref.		EAN
06-107	0/10	5907558414424

H7, H10, H11, H13, H14, H17, H19, H22, H24
TS10, TS15, TS20, TS25, TS27, TS30, TS40, TS45, TS50
T30, T40, T45, T50, T55, T60, T70, T80
M9, M10, M12, M14, M16
R7, R8, R9, R10
H5

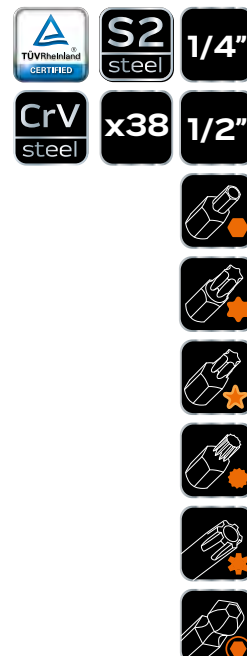

Ref.		EAN
08-710	0/3	5907558417104



Końcówki wkrętakowe

Driver bits / Einsätze für Schraubendreher / Насадки / Наконечники викрутки / Dugókulcs bitkészlet / Set biti / Šraubovákové nástavce / Skrutkovacie nástavce / Nastavki za izvijače / Atsuktuvo antgaliai / Skrtvgrieža uzgaļi / Krivikeerajaotsakud / Накрайници за отвёртка / Nastavci za odvijač / Nastavci za odvijač / Καταβιδόμετες / Puntas destornilladoras / Inserti lunghi e corti / Ponteiros Chave de fenda / Embouts de tournevis / Schroevendraaiereindstukken



Ref.	Info	L[mm]	☒	EAN
10-970	H5	30	50/200	5907558452884
10-972	H6	30	50/200	5907558452891
10-978	H12	30	50/200	5907558452907
10-980	H5	75	30/120	5907558452914
10-982	H6	75	30/120	5907558452921
10-988	H12	75	30/120	5907558452938



Ref.	Info	L[mm]	☒	EAN
10-920	T30	30	50/200	5907558452785
10-922	T40	30	50/200	5907558452792
10-924	T45	30	50/200	5907558452808
10-926	T50	30	50/200	5907558452815
10-928	T55	30	50/200	5907558452822
10-940	T30	75	30/120	5907558452839
10-942	T40	75	30/120	5907558452846
10-944	T45	75	30/120	5907558452853
10-946	T50	75	30/120	5907558452860
10-948	T55	75	30/120	5907558452877
10-960	T100	75	20/40	5907558452945

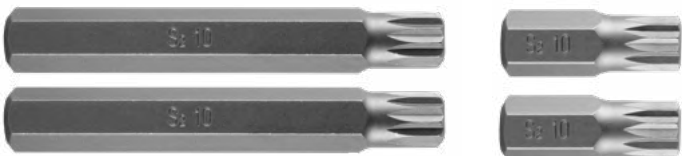

Ref.	Info	L[mm]	☒	EAN
10-900	M8	30	50/200	5907558452723
10-902	M10	30	50/200	5907558452730
10-904	M12	30	50/200	5907558452747
10-906	M8	75	30/120	5907558452754
10-908	M10	75	30/120	5907558452761
10-910	M12	75	30/120	5907558452778



Klucze sześciokątne

Hex key set / Sechskantschlüssel / Ключи шестигранные / Ключ шестигранный / Imbuskulcs készlet / Set chei cu șase laturi / Šestihránný klíč / Šiprava imbus ključov (dlhé) / Garnitura imbus ključev / Šešakampij raktų komplektas / Seškanšu atslēgu komplekts / Kuuskant-mutrivõtmete komplekt / Лумбусу компл. / Ključ imbus set / Ключ имбус set / Συλλογή εξαγωνικών κλειδίων / Llaves Allen / Chiavi esagonali / Chaves hexagonais / Clefs à 6 pans / Zeskantsleutels

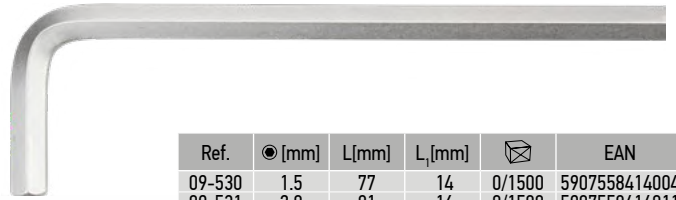
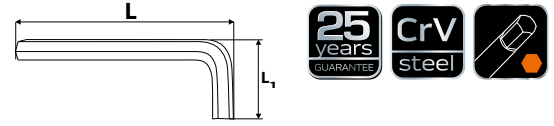

Ref.	☉[mm]	L[mm]	L ₁ [mm]	☒	EAN
09-530	1.5	77	14	0/1500	5907558414004
09-531	2.0	81	16	0/1500	5907558414011
09-532	2.5	87	18	0/1500	5907558414028
09-533	3.0	94	20	0/1500	5907558414035
09-534	4.0	103	24	0/1000	5907558414042
09-535	4.5	108	26	0/800	5907558414059
09-536	5.0	115	28	0/500	5907558414066
09-537	5.5	122	30	0/500	5907558414073
09-538	6.0	129	32	0/500	5907558414080
09-539	7.0	136	34	0/300	5907558414097
09-540	8.0	147	36	0/200	5907558414103
09-541	9.0	159	38	0/200	5907558414110
09-542	10.0	170	40	0/150	5907558414127
09-543	12.0	190	45	0/80	5907558414134
09-544	13.0	205	48	0/80	5907558414141
09-545	14.0	216	54	0/60	5907558414158
09-546	17.0	245	63	0/40	5907558414165



☉[mm]	L[mm]	L ₁ [mm]
2.0	85	18
2.5	90	20
3.0	97	23
4.0	106	28
5.0	118	30
6.0	138	36
8.0	159	40
10.0	180	46

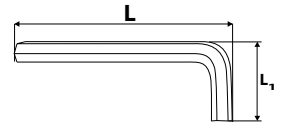

Ref.	☒	EAN
09-523	10/40	5907558414288



☉[mm]	L[mm]	L ₁ [mm]
1.5	92	15
2.0	100	18
2.5	114	20
3.0	127	22
4.0	143	28
5.0	164	31
6.0	185	37
8.0	205	43
10.0	235	47

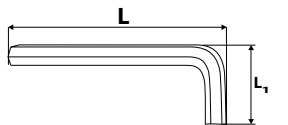

Ref.	☒	EAN
09-525	6/24	5907558414301



Klucze sześciokątne

Hex key set / Sechskantschlüssel / Ключи шестигранные / Ключ шестигранный / Imbuskulcs készlet / Set chei cu șase laturi / Šestihranný klíč / Súpava imbus ključov (dlhè) / Garnitura imbus ključev / Šešakampij raktų komplektas / Seškanšu atslēgu komplekts / Kuuskant-mutrivõtmete komplekt / Лимбуси компл. / Ključ imbus set / Ključ imbus set / Συλλογή εξαγωνικών κλειδίων / Llaves Allen / Chiavi esagonali / Chaves hexagonais / Clefs à 6 pans / Zeskantsleutels

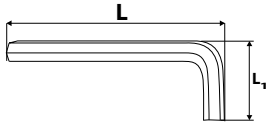

Ø [mm]	L [mm]	L ₁ [mm]
1.5	91	16
2.0	103	19
2.5	115	20
3.0	130	23
4.0	145	29
5.0	166	35
6.0	188	38
8.0	208	43
10.0	230	50



Ref.	⊠	EAN
09-512	6/48	5907558403428



Ø [mm]	L [mm]	L ₁ [mm]
1.5	63	15
2.0	75	17
2.5	87	20
3.0	90	23
4.0	100	27
5.0	116	32
6.0	137	37



Ref.	⊠	EAN
09-517	10/100	5907558410273



Ø [mm]	L [mm]	L ₁ [mm]
1.5	92	15
2.0	100	18
2.5	114	20
3.0	127	22
4.0	143	28
5.0	164	31
6.0	185	37
8.0	205	43
10.0	235	47



Ref.	⊠	EAN
09-515	12/48	5907558409314

● 1.5-2-2.5-3-4-5-6-8 mm



Ref.	⊠	EAN
09-571	6/24	5907558450460

Klucze Torx

Torx key wrench set / Torx-Schlüssel / Ключи Torx / Ключи "Torx" / Torx kulcskészlet / Set chei de tip "torx" / Klíče Torx / Súpava Torx ključov / Garnitura ključev torx / Raktai TORX / Torx atslēgu komplekts / "Torx" mutrivõtmete komplekt / Лимбуси компл. / Ključ imbus / Κλειδιά Torx / Llaves torx / Set chiavi Torx / Chaves torx / Clefs Torx / Torxsleutels

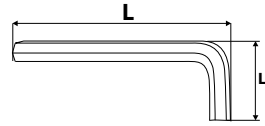

Ref.	⊠	L [mm]	L ₁ [mm]	⊠	EAN
09-550	T10	77	14	0/1500	5907558414172
09-551	T15	84	16	0/1500	5907558414189
09-552	T20	92	18	0/1000	5907558414196
09-553	T25	101	20	0/1000	5907558414202
09-554	T27	111	24	0/500	5907558414219
09-555	T30	122	28	0/500	5907558414226
09-556	T40	136	32	0/400	5907558414233
09-557	T45	152	36	0/300	5907558414240
09-558	T50	176	40	0/200	5907558414257
09-559	T55	183	44	0/100	5907558414264



⊠	L [mm]	L ₁ [mm]
TT10	88	20
TT15	93	22
TT20	98	23
TT25	105	24
TT30	119	30
TT40	130	32
TT45	144	37
TT50	160	40

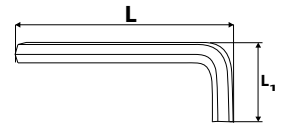

Ref.	⊠	EAN
09-514	6/36	5907558403428



⊠	L [mm]	L ₁ [mm]
TT10	88	20
TT15	93	22
TT20	98	23
TT25	105	24
TT30	119	30
TT40	130	32
TT45	144	37
TT50	160	40

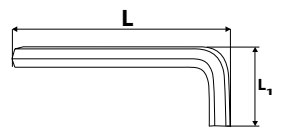

Ref.	⊠	EAN
09-524	10/40	5907558414295



Klucze Torx

Torx key wrench set / Torx-Schlüssel / Ключи Torx / Ключи "Torx" / Torx kulcskészlet / Set chei de tip "torx" / Klíče Torx / Súprava Torx ključov / Garnitura ključev torx / Raktai TORX / Torx atslegu komplekts / "Torx" multivõtmete komplekt / Лимбуси компл. / Кључ имбус / Кљедіа Torx / Llaves torx / Set chiavi Torx / Chaves torx / Clefs Torx / Torxslutles



⚙️	L[mm]	L ₁ [mm]
T10	89	20
T15	105	22
T20	115	23
T25	130	25
T27	146	30
T30	167	35
T40	184	38
T45	204	45
T50	226	50

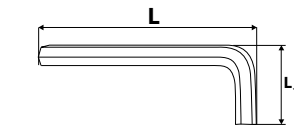

Ref.	📦	EAN
09-518	6/48	5907558420661

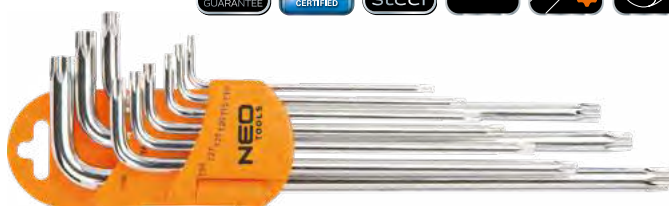

⚙️	L[mm]	L ₁ [mm]
T10	89	20
T15	105	22
T20	115	23
T25	130	25
T27	146	30
T30	167	35
T40	184	38
T45	204	45
T50	226	50

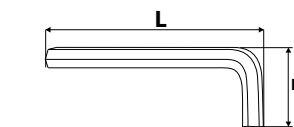

Ref.	📦	EAN
09-516	12/48	5907558409321



⚙️	L[mm]	L ₁ [mm]
T10	89	20
T15	105	22
T20	115	23
T25	130	25
T27	146	30
T30	167	35
T40	184	38
T45	204	45
T50	226	50

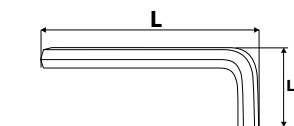

Ref.	📦	EAN
09-526	6/24	5907558414318

⚙️ T9; T10; T15; T20; T25; T27; T30; T40



Ref.	📦	EAN
09-573	6/24	5907558450477

Kluczyk uniwersalny do szafek

Universal control cabinet key / Universalschlüssel für Schränke / Ключ универсальный для шкафов / Ключ универсальный до шаф / Chiave universale per armadietti / Cheie univesala pentru dulapuri / Univerzální klič na rozvodné skříně / Univerzálny klúčik na skrinky / Univerzalni ključ za električne omarice / Elektros spintelių raktas, universalus / Universāla atslēga skapjiem / Universaalne karinvõti / Универсален ключ за шкафчета / Univerzalni ključ za ormare / Univerzalni ključ / Кљедіа γενικής χρήσης για ντουλάπια εργασιών / Llave universal para armarios / Chiave universale per armadietti / Chave universal para armários / Clé pour armoires universelle



Ref.	📦	EAN
02-001	50/200	5907558404319



Ref.	📦	EAN
01-402	24/192	5907558449631



Pokrętko

Wheel / Drehknopf / Вороток / Маховик / Hajtákar / Clupř / Otočný knoflík / Ovládací koliesko / Raglja / Rankena / Grietzvite / Nupp / Върток / Kotačici / Ručica / Πόμολο / Mango / Impugnatura a L / Botão / Tourne-à-gauche / Draaiknop



Ref.	☒	EAN
08-257	10/100	5907558466362

Klucz dynamometryczny

Torque wrench / Drehmomentschlüssel / Ключ динамометрический / Ключ динамометричний / Nyomatékkulcs / Cheie dinamometrică / Dynamometrický klíč / Dynamometrický klúč / Dynamometrični ključ / Dinamometrinis raktas / Dinamometriska atslēga / Dīnamoetriline vārti / Динамометричен ключ / Dinamometrički ključ / Obrtni ključ / Δυναμομετρικό κλειδί / Llave dinamométrica / Chiave dinamometrica / Chave dinamométrica / Clef dynamométrique / Dynamometrische steultel

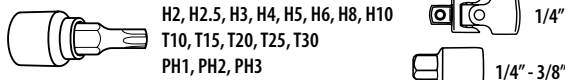

Ref.	☒	EAN
08-821	0/12	5907558458954



Ref.	Info	☒	EAN
08-835	40-220Nm	0/6	5907558458930
08-837	60-330Nm	0/6	5907558458947



Ref.	Info	☒	EAN
08-823	3/8", 10 - 60 Nm	1/10	5907558444544
08-824	3/8", 20 - 100 Nm	1/10	5907558444551
08-825	1/2", 40 - 200 Nm	1/10	5907558444568
08-826	1/2", 60 - 350 Nm	1/4	5907558444599



Ref.	Info	☒	EAN
08-827	1/2", 20 - 210 Nm	1/10	5907558444575
08-828	1/2", 60 - 350 Nm	1/10	5907558444582



Ref.	Info	☒	EAN
08-822	5-25Nm	1/20	5907558471168



Ref.	Info	☒	EAN
08-838	160-800Nm	1/2	5907558469745
08-839	20-1000Nm	1/2	5907558469752



Ref.	Info	☒	EAN
08-843	5-350Nm	1/4	5907558471168



Ref.	Info	☒	EAN
08-845	5-330Nm	1/2	5907558463538



Kątomierz do dokręcania śrub

Torque angle gauge / Winkelmesser zum schraubenanziehen / Угломер для затяжки болтов / Кутомір для догвинчування гвинтів / Szögmérő csavar meghúzásához / Raportor la strângerea șuruburilor / Úhloměr k utahování šroubů / Uhlomer krútiaceho momentu / Kotomer za privijanje vijakov / Varžica užsraudimo kamro matuoklis / Leņķmērs skrūvju pievilkšanai / Nurgatōdīk poltide pingutamiseks / Ёгломер за динмометричне ключ / Kutomer za zatezanje vijaka / Uglomer za zavrtanje šrafova / Γωνιόμετρο σύσφιξης βιδών / Escuadra para atornillar tornillos / Goniometro per avvitare le viti / Transferidor para aparafusar / Clé de serrage angulaire



Ref.	📦	EAN
08-830	1/12	5907558416770

1/2"

360°

Klucz płasko-oczkowy

Combination spanner / Maul-Ringschlüssel / Ключ комбинированный / Ключ комбінований, ріжково-накидний / Csillag-villáskulcs / Cheie combinată / Ključ očko-plochy / Ključ OP / Ključ viličasto-obročni / Raktas plokščias - kilpinis / Kombinētā atslēga / Universaalne mutrivõti / Ключ звездогаечен / Ključ kombinirani / Ključ kombinovani / Γερανοπολύγωνο / Llave combinada / Chiave combinata / Chave plana-de luneta / Clef à fourche-polygonale / Moersleutel



Ref.	● [mm]	L [mm]	📦	EAN	Ref.	● [mm]	L [mm]	📦	EAN
09-706	6	100	0/200	5907558410914	09-722	22	260	5/50	5907558411072
09-707	7	110	5/200	5907558410921	09-723	23	260	5/30	5907558411089
09-708	8	120	5/200	5907558410938	09-724	24	280	5/50	5907558411096
09-709	9	130	5/200	5907558410945	09-725	25	295	5/40	5907558411102
09-710	10	140	5/200	5907558410952	09-727	27	310	5/50	5907558411126
09-711	11	150	5/200	5907558410969	09-728	28	310	5/40	5907558411133
09-712	12	160	5/200	5907558410976	09-729	29	340	4/40	5907558411140
09-713	13	170	5/200	5907558410983	09-730	30	340	4/30	5907558411157
09-714	14	180	5/100	5907558410990	09-732	32	360	4/40	5907558411164
09-715	15	190	5/100	5907558411003	09-734	34	380	4/20	5907558411171
09-716	16	200	5/100	5907558411010	09-736	36	410	5/10	5907558412611
09-717	17	210	5/100	5907558411027	09-738	38	430	5/20	5907558412628
09-718	18	220	5/100	5907558411034	09-741	41	460	2/10	5907558412635
09-719	19	230	5/100	5907558411041	09-746	46	500	5/10	5907558412642
09-720	20	240	5/100	5907558411058	09-747	50	540	5/10	5907558412659
09-721	21	250	5/100	5907558411065	09-749	60	600	0/2	5907558412673



Ref.	● [mm]	L [mm]	📦	EAN
09-406	6	100	25/400	5907558422375
09-407	7	110	25/400	5907558422382
09-408	8	120	25/400	5907558422399
09-409	9	130	25/400	5907558422405
09-410	10	140	25/400	5907558422412
09-411	11	150	25/300	5907558422429
09-412	12	160	25/300	5907558422436
09-413	13	170	25/300	5907558422443
09-414	14	180	25/200	5907558422450
09-415	15	190	25/200	5907558422467
09-416	16	200	25/150	5907558422474
09-417	17	210	25/150	5907558422481
09-418	18	220	10/120	5907558422498
09-419	19	230	10/120	5907558422504
09-421	21	250	10/100	5907558422528
09-422	22	260	10/100	5907558422535
09-424	24	280	10/80	5907558422559
09-427	27	310	10/40	5907558422580
09-429	29	340	10/40	5907558422603
09-430	30	340	10/40	5907558422610
09-432	32	360	10/40	5907558422627

Ref.	● [mm]	L [mm]	📦	EAN
09-650	6	100	1/25	5907558467482
09-651	7	110	1/25	5907558467499
09-652	8	120	1/25	5907558467505
09-653	9	130	1/25	5907558467512
09-654	10	140	1/25	5907558467529
09-655	11	150	1/25	5907558467536
09-656	12	160	1/25	5907558467543
09-657	13	170	1/25	5907558467550
09-658	14	180	1/25	5907558467557
09-659	15	190	1/25	5907558467564
09-660	16	200	1/25	5907558467571
09-661	17	210	1/25	5907558467578
09-662	18	220	1/10	5907558467604
09-663	19	230	1/10	5907558467611
09-665	21	250	1/10	5907558467628
09-666	22	260	1/10	5907558467635
09-668	24	280	1/10	5907558467642
09-671	27	310	1/10	5907558467659
09-672	29	340	1/10	5907558467666
09-674	30	340	1/10	5907558467673
09-675	32	360	1/10	5907558467680



Klucz płasko-oczkowy

Combination spanner / Maul-Ringschlüssel / Ключ комбинированный / Ключ комбінований, ріжково-накидний / Csillag-villáskulcs / Cheie combinată / Кліч ошко-пlochý / Кліч OP / Кључ виљчasto-оброчни / Raktas plokščias - kilpinis / Kombinētā atslēga / Universaalne mutrivõti / Ключ звездозагачен / Кључ комбинирани / Кључ комбиновани / Γερμανοπολύγωνο / Llave combinada / Chiave combinata / Chave plana-de luneta / Clef à fourche-polygonale / Moersleutel

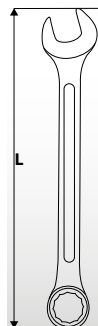

Ref.	● [mm]	L [mm]	📦	EAN
09-760	8	90	10/200	5907558410198
09-761	9	93	5/200	5907558410204
09-762	10	96	5/200	5907558410211
09-763	11	98	10/200	5907558410228
09-764	12	102	10/200	5907558410235
09-765	13	109	5/200	5907558410242
09-766	14	113	10/200	5907558410259
09-767	15	118	10/120	5907558410266
09-768	16	123	10/120	5907558412765
09-769	17	129	10/200	5907558412772
09-770	18	131	10/120	5907558412789
09-771	19	134	10/150	5907558412796

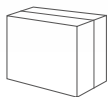

Ref.	● [mm]	N	📦	EAN
09-750	6, 8, 10, 13, 15, 17	x6	0/25	5907558411515
09-751	6, 8, 10, 12, 13, 14, 17, 19	x8	0/25	5907558411522
09-752	6, 7, 8, 10, 11, 12, 13, 14, 15, 17, 19, 22	x12	0/20	5907558411539
09-753	8, 9, 10, 11, 12, 13, 14, 15, 16, 17, 18, 19, 22, 24, 27, 30, 32	x17	0/6	5907558413106
09-754	6, 7, 8, 9, 10, 11, 12, 13, 14, 15, 16, 17, 18, 19, 20, 21, 22, 23, 24, 25, 26, 27, 28, 29, 30, 32	x26	0/4	5907558413113

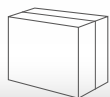

Ref.	● [mm]	📦	EAN
09-791	8, 9, 10, 12, 13, 14, 17, 19	0/20	5907558413090

Klucz płasko-oczkowy z grzechotką

Combination spanner with ratchet / Ringschlüssel mit Ratsche / Ключ комбинированный с трещоткой / Кључ ріжково-накидний з трісчаткою / Csillag-villáskulcs racsnis / Cheie fixă -inelară cu clichet / Očkoplochý klíč ráčnový / Plochý-očkový klíč s račňou / Ploščato-obročni ključ z ragljo / Raktas plokščias, kilpinis su terkšle / Kombinētā atslēga / Kārstīga leht-siltmusvõti / Комбинирана тресчатка / Posnato-okasti ključ s nastavkom / Pljosnato-okasti ključ sa čeragaljom / Κλειδί γερμανοπολύγωνο με καστάνια / Llaves combinadas (de estrella y a carraca abierta) con carraca / Chiave combinata a cricchetto / Chave plana-de luneta z catraca de furar / Clef à fourche-polygonale à cliquet / Moersleutel met ratel

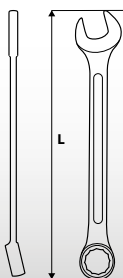

Ref.	● [mm]	L [mm]	📦	EAN
09-063	8	140	10/200	5907558424157
09-064	10	160	10/200	5907558416954
09-065	13	180	10/50	5907558416961
09-066	15	190	10/100	5907558416978
09-067	17	213	0/100	5907558416985
09-068	19	235	10/60	5907558416992
09-069	21	237	10/50	5907558424164
09-042	22	252	5/50	5907558424041
09-043	24	274	5/50	5907558424058
09-044	27	332	6/30	5907558424065
09-045	30	349	6/24	5907558424072

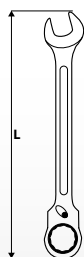

Ref.	● [mm]	L [mm]	📦	EAN
09-320	8 mm	20	10/100	5907558444919
09-321	9 mm	21	10/100	5907558444926
09-322	10 mm	22	10/100	5907558444933
09-323	11 mm	22	10/100	5907558444940
09-324	12 mm	23	10/100	5907558444957
09-325	13 mm	26	5/100	5907558444964
09-326	14 mm	27	5/100	5907558444971
09-327	15 mm	27	5/50	5907558444988
09-328	16 mm	28	5/50	5907558444995
09-329	17 mm	30	5/50	5907558445008
09-330	18 mm	31	5/50	5907558445015
09-331	19 mm	32	5/50	5907558445022
09-333	21 mm	38	5/50	5907558445046
09-334	22 mm	38	5/50	5907558445053
09-336	24 mm	42	5/25	5907558445077
09-338	26 mm	45	5/25	5907558445091
09-339	27 mm	45	5/25	5907558445107
09-340	28 mm	49	5/25	5907558445114
09-341	30 mm	49	5/20	5907558445121
09-342	32 mm	52	5/20	5907558445138



Ref.	● [mm]	L [mm]	📦	EAN
09-051	8	140	10/200	5907558403435
09-052	10	162	10/160	5907558403442
09-055	13	181	10/120	5907558403459
09-057	15	202	10/100	5907558403466
09-059	17	237	10/80	5907558403473
09-061	19	250	10/60	5907558403480
09-062	21	255	10/50	5907558424140
09-053	22	255	5/50	5907558424096
09-054	24	274	5/50	5907558424102
09-056	27	312	5/30	5907558424119
09-058	30	350	6/24	5907558424126
09-060	32	390	8/16	5907558424133



Klucz płasko-oczkowy z grzechotką

Combination spanner with ratchet / Ringschlüssel mit Ratsche / Ключ комбинированный с трещоткой / Ключ рижково-накидной з трісчаткою / Csillag-villáskulcs racsnis / Cheie fixă –inelară cu clichet / Očkový kľúč ráčnový / Plochý-očkový kľúč s račňou / Ploščato-obročni kľuč z ragľo / Raktas plokščias, kilpinis su terkšle / Kombinētā atslēga / Kārstīga leht-siltmusvōti / Комбинирана тресчотка / Plosnato-okasti kľuč s nastavkom / Pļosnato-okasti kľuč sa čegrtaļķom / Κλειδί γερμανοπολύγωνο με καστίνα / Llaves combinadas (de estrella y a carraca abierta) con carraca / Chiave combinata a cricchetto / Chave plana-de luneta z catraca de furar / Clef à fourche-polygonale à cliquet / Moersleutel met ratel



CrV
steel

x12

Klucze płaskie dwustronne

Flat double sided wrenches / Mutterschlüssel, beidseitig / Ключи с открытым зевом двухсторонние / Ключи рижкові двобічні / Villáskulcs készet / Cheie fixa / Kľúče ploché oboustranné / Kľúče ploché obojstranné / Ploščati obojestranski kľučji / Plokšti raktai, dvipusiai / Divpusēja plakana atslēga / Kahepoolsed lehtvõtmed / Пlosки двосторонні ключовые / Dvostrani plosnati kľučevji / Dvačeljusni pļosnati kľučevji / Γερμανικό κλειδί διπλο / Llaves fijas dobles / Chiavi a forchetta doppia / Chaves planas de duas pontas / Clefs à fourches doubles / Vakke tweezijdige sleutels

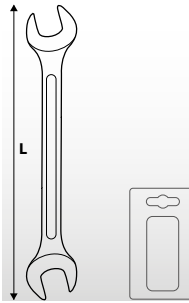

Ref.	● [mm]	L [mm]	☒	EAN
09-806	6x7	120	10/600	5907558411195
09-808	8x9	140	10/200	5907558411201
09-810	10x11	160	10/300	5907558411218
09-812	12x13	170	10/200	5907558411225
09-814	14x15	190	10/100	5907558411232
09-816	16x17	200	10/100	5907558411249
09-817	17x19	220	10/100	5907558411454
09-818	18x19	220	5/100	5907558411256
09-819	19x22	234	10/100	5907558411461
09-820	20x22	230	5/100	5907558411263
09-821	21x23	250	5/100	5907558411270
09-824	24x27	270	5/50	5907558411287
09-825	25x28	285	5/50	5907558411294



25
years
GUARANTEE

TÜV
Rheinland
CERTIFIED

CrV
steel

DIN
3110

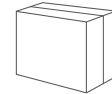

Ref.	● [mm]	N	☒	EAN
09-851	6x7, 8x9, 10x11, 12x13, 14x15, 16x17, 18x19, 20x22	8	0/20	5907558411546
09-852	6x7, 8x9, 10x11, 12x13, 14x15, 16x17, 18x19, 20x22, 21x23, 24x27, 25x28, 30x32	12	0/8	5907558413120

Klucz oczkowy półotwarty

Flare nut wrench / Ringschlüssel halboffen / Ключ разрезной двухсторонний / Ключ торцевий нарізний двосторонній / Fékcsőkulcs / Cheie piulită în formă de con / Očkový kľúč polootevřený / Kľúč otvorenej očkovy / Obročni kľuč, odprti / Kilpinis raktas / Bremžu trubiju atslēga / Vargamutri vōti / Ключ гаечен / Kľuč ekscentrični / Kľuč / Πολύγωνο κλειδί ημίανοιχο / Llave de estrella, abierta / Chiave doppia ad anello aperto / Chave de luneta semi aberta / Clef polygonale demi ouverte / Halfopen ringsleutel

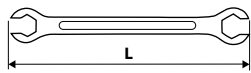

Ref.	● [mm]	L [mm]	☒	EAN
09-141	8x9	130	25/100	5907558404746
09-143	9x11	150	10/200	5907558404753
09-145	10x12	150	10/200	5907558404760
09-147	12x13	170	25/200	5907558404777
09-149	13x14	170	25/100	5907558404784
09-151	15x17	195	25/100	5907558404791

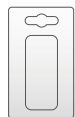

CS
steel

SUPER
THIN

x8

Ref.	● [mm]	☒	EAN
09-860	5,5x7, 8x9, 10x12, 11x13, 14x17, 19x21, 22x23, 24x27	0/20	5907558458916



Klucz oczkowy odgięty

Offset ring spanner / Ringschlüssel, gebogen / Ключ накидной изогнутый / Ключ накидний, вигнутий / Csillagkulcs enyhén hajlított / Cheie inelară-cotita / Кліч оцковий ухнутий / Оцковий кліч огнутий / Оброčni upognjeni ključ / Kilpinis raktas, lenktas / Izliekta uzmanas atslėga / Kõvera otsaga silmsuvõti / Глух гаечен ключ отъгнат / Fleksibilni okasti ključ / Okasti ključ obrnuti / Клеиди полугувно курто / Llave de estrella acodada / Chiave poligonale doppia / Chave de luneta curvado / Clef polygonale contre-coudée / Gebogen ringsleutel

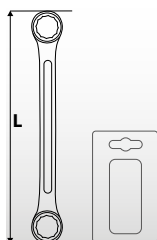

Ref.	● [mm]	L [mm]	☒	EAN
09-906	6x7	170	5/100	5907558411317
09-908	8x9	180	5/100	5907558411324
09-910	10x11	200	5/100	5907558411331
09-912	12x13	210	5/100	5907558411348
09-914	14x15	230	5/60	5907558411355
09-916	16x17	245	5/100	5907558411362
09-918	18x19	265	5/50	5907558411379
09-920	20x22	290	5/40	5907558411386
09-921	21x23	310	4/40	5907558411393
09-924	24x27	330	4/40	5907558411409
09-930	30x32	370	4/40	5907558411430

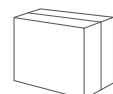

Ref.	● [mm]	☒	EAN
09-952	6x7, 8x9, 10x11, 12x13, 14x15, 16x17, 18x19, 20x22, 21x23, 24x27, 25x28, 30x32	0/6	5907558413137

Klucze oczkowe wygięte

Offset ring spanner / Ringschlüssel, gebogen / Ключ накидной изогнутый / Ключ накидний, вигнутий / Csillagkulcs készlet / Cheie inelară semiluna / Оцковий кліч загнутий / Оцковий кліч ухнутий / Оброčni ukivljenji ključ / Kilpiniai raktai / Izliekta uzmanas atslėga / Poolkuu-silmsuvõti / Глух гаечен ключ отъгнат / Okasti savinut ključ / Okasti izvijeni ključ / Клеиди полугувно курто / Llave de estrella de media luna / Chiavi doppie poligonale a mezza luna / Chaves de luneta curvadas / Clefs polygonales coudées / Uitgebogen ringsleutels

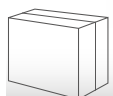

Ref.	● [mm]	☒	EAN
09-176	9x12, 13x15, 14x17, 16x18, 19x22	0/10	5907558404876

Klucz oczkowy

Ring spanner / Ringschlüssel / Ключ накидной / Ключ накидний / Csillagkulcs / Cheie inelară / Оцковий кліч / Оброčni ključ / Kilpinis raktas / Uzmaucama atslėga / Silmsuvõti / Глух гаечен ключ / Okasti ključ / Okasti ključ / Πολύγωνο κλειδί / Llave de estrella / Chave de luneta / Clef polygonale / Ringsleutel



Ref.	● [mm]	L [mm]	☒	EAN
09-360	8 mm	235	10/100	5907558445145
09-361	10 mm	289	10/100	5907558445152
09-362	12 mm	325	10/100	5907558445169
09-363	13 mm	360	5/50	5907558445176
09-364	14 mm	363	5/50	5907558445183
09-365	16 mm	390	5/50	5907558445190
09-366	17 mm	403	5/50	5907558445206
09-367	19 mm	425	5/50	5907558445213
09-368	22 mm	450	5/25	5907558445220



Ref.	● [mm]	☒	EAN
09-370	8, 10, 13, 16, 17, 19		5907558483109



Ref.	● [mm]	☒	EAN
03-030	5 - 16	5/40	5907558445268
03-031	5 - 27	5/20	5907558445275

Klucze oczkowe Torx

Offset ring spanner set / Ringschlüssel / Ключи накидные колпачковые / Ключи накидні / Csillagkulcs készlet torx / Set chei inelară de deviație / Кліче оцкові / Súprava očkových ključov / Obročni ključ / Kilpiniai raktai / Kombineto izliekto atslėgu komplekts / Nutrivõtmete komplekt / Ключ Луна компл. / Ključ okasti / Πολύγωνο κλειδιά / Llaves de estrella / Chiavi combinate Torx / Chaves de luneta / Clefs polygonales / Ringsleutels



Ref.	★ [mm]	☒	EAN
09-980	T6xT8, T10xT12, T14xT18, T20xT24	20/60	5907558412239



Klucz trzpieniowy nasadowy

T-socket wrench / Vierkant-Aufsteckschlüssel / Ключ торцевой Т-образный / Ключ шестигранный торцевой накидной / T-kulcs / Cheie fixare forma T / Nástrčkový kľúč typu T / T ključ / T ključ, nasadni / T formas raktas / T-veida gala atslēga / T-padrūni mutrīvīti / T-образен ключ / T Kľuč / T ključ / Καταβίβακι καρυδάκι τύπου T / Llave de vaso con mango en T / Chiave a T / Chave tubular / Clef mâle à douilles articulée / Imbusdopsleutel

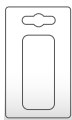
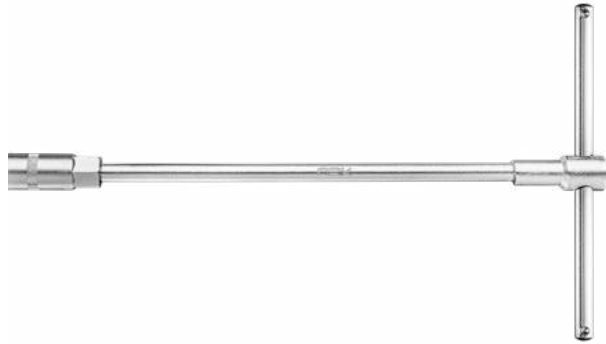

Ref.	● [mm]	L [mm]	📦	EAN
09-302	13	300	25/50	5907558414363

Klucz fajkowy

L-type wrench / Pfeifenschlüssel / Рожковый ключ / Ключ торцовый кривой / Pipakulcs / Cheie tubulară cotită / Zahnutý kľúč / Fajkový kľúč / Угробнен кључ / Рупкинis raktas / radzipatslēga / Padrunvōti / Ключ лупа / imbus kľuč / Kosočeljusni zavrtjnani kľuč / Γερμανικό κλειδί / Llave de pipa / Chiave a pipa / Chave de cabo curvo / Clef à pipe / Pijpsleutel

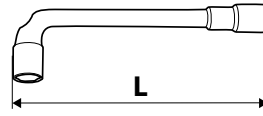

Ref.	● [mm]	L [mm]	📦	EAN
09-203	8	110	10/200	5907558405002
09-205	10	130	10/120	5907558405019
09-208	13	150	10/100	5907558405033
09-212	17	180	10/60	5907558405064
09-214	19	200	10/40	5907558405071

Wkręтак płaski

Screwdriver slotted / Flachsraubendreher / Отвертка плоская / Відкрутка плоска / Csavarhúzó lapos / şurubelnîță plată / Šroubovák plochý / Skrutkovač plochý / Ploščati izvijač / Ploščias atsuktuvas / Skrūvgriezis plakans / Лампепа-кривкеераја / Отвертка / Odvijač / Odvijač / Καταβίβακι εγχοηής / Destornillador plano / Giravite piatto / Chave de fenda plana / Tournevis à fourche / Vlakke schroevendraaier

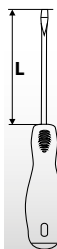

Ref.	⌀ [mm]	L [mm]	📦	EAN
04-011	3,0	75	12/240	5907558401745
04-012	4,0	100	12/240	5907558401752
04-013	5,5	100	12/120	5907558401769
04-014	5,5	200	12/144	5907558401776
04-001	6,5	38	12/288	5907558411638
04-002	6,5	125	12/144	5907558411645
04-015	6,5	150	12/144	5907558401783
04-016	8,0	200	12/120	5907558401790
04-004	10,0	200	6/96	5907558411669

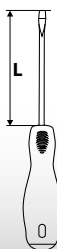

Ref.	⌀ [mm]	L [mm]	📦	EAN
04-171	3,0	75	12/240	5907558440386
04-172	4,0	100	12/240	5907558440393
04-173	5,5	38	12/240	5907558440409
04-174	5,5	100	12/120	5907558440416
04-175	6,5	150	12/120	5907558440423
04-176	8,0	200	6/60	5907558440430

Wkręтак krzyżowy PH

Screwdriver Phillips / Kreuzschraubendreher / Отвертка крестовая / Відкрутка крестовидна / Csavarhúzó philips / şurubelnîță tip „Phillips” / Šroubovák křížový / Skrutkovač PH / Křížni izvijač / Kryžminis atsuktuvas / Phillips / Skrūvgriezis krusta PH / Ristpeakrivikeeraја / Отвертка / Odvijač / Odvijač / Καταβίβακι σταυρωτά τύπου phillips / Destornillador phillips / Giravite Phillips / Chave de fenda de cruzeta / Tournevis en croix / Kriusschroevendraaier

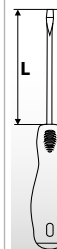

Ref.	⊕	L [mm]	📦	EAN
04-021	PH0	75	12/240	5907558401806
04-006	PH1	75	12/240	5907558411683
04-022	PH1	100	12/240	5907558401813
04-023	PH2	38	12/288	5907558401820
04-024	PH2	100	12/120	5907558401837
04-007	PH2	150	12/180	5907558411713
04-025	PH2	200	12/144	5907558401844
04-026	PH3	150	12/120	5907558401851

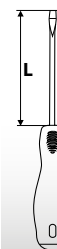

Ref.	⊕	L [mm]	📦	EAN
04-177	PH0	75	12/240	5907558440447
04-178	PH1	100	12/120	5907558440454
04-179	PH2	38	12/240	5907558440461
04-180	PH2	100	12/120	5907558440478
04-181	PH3	150	6/60	5907558440485



Wkrętak krzyżowy PZ

Screwdriver Pozidriv / Kreuzschraubendreher / Отвертка крестовая / Відкрутка крестовидна / Csavarhúzó pozidriv / şurubelnijâ tip „Pozidriv” / Šroubovák křížový / Skrutkovač PZ / Křížni izvijač / Kryžminis atsuktavas Phillips / Skrūvgrizis krusta PZ / Ristpeakruvikeeraja Pozidriv / Отвертка / Одвијач / Одвијач / Καταβίβι τύπου pozidriv / Destornillador phillips / Giravite Pozzi / Chave de fenda de cruzeta / Tournevis en croix / Kriusschroevendraaier

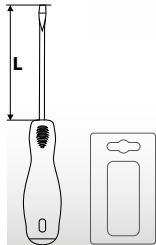

Ref.	⊕	L [mm]	📦	EAN
04-031	PZ0	75	12/600	5907558401868
04-032	PZ1	100	12/120	5907558401875
04-033	PZ2	38	12/288	5907558401882
04-034	PZ2	100	12/144	5907558401899
04-035	PZ2	200	12/144	5907558401905
04-036	PZ3	150	12/120	5907558401912

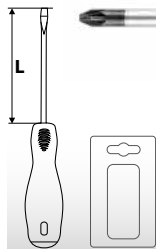

Ref.	⊕	L [mm]	📦	EAN
04-182	PZ0	100	12/240	5907558440492
04-183	PZ1	100	12/120	5907558440508
04-184	PZ2	100	12/120	5907558440515
04-185	PZ3	150	6/60	5907558440522

Wkrętak Torx

Torx screwdriver / Schraubendreher Torx / Отвертка Torx / Вкрутка «Torx» / Csavarhúzó torx / Surubelnijâ varf Torx / Šroubovák Torx / Skrutkovač Torx / Izvijač Torx / Atsuktavas, torcinis / Torx skrūvgrizis / Torx-kruvikeeraja / Отвертка Torx / Одвијач Torx / Одвијач Torx / Καταβίβι Torx / Destornillador con punta torx / Giravite Torx / Chave de fenda Torx / Tournevis Torx / Torx schroevendraaier

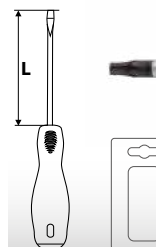

Ref.	⊕	L [mm]	📦	EAN
04-044	T15	100	12/240	5907558401936
04-045	T20	100	12/240	5907558401943
04-046	T25	100	12/144	5907558401950

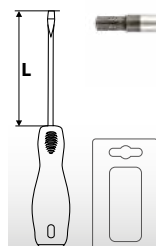

Ref.	⊕	L [mm]	📦	EAN
04-186	T10	100	12/120	5907558440539
04-187	T15	100	12/240	5907558440546
04-188	T20	100	12/240	5907558440553
04-189	T25	100	12/144	5907558440560
04-190	T27	100	12/144	5907558440577

Wkrętak płaski do pobijania

Slotted screwdriver go through / Schraubendreher, flach / Отвертка шлицевая ударная / Викрутка плоска, ударна / Csavarhúzó üthető lapos / Surubelnijâ impact varf drept / Šroubovák plochy úderový / Sekací plochy skrutkovač / Ploščati izvijač za zabijanje / Smūginis, plokščias atsuktavas / Plakanais skrūvgrizis / Lame löökkruvikeeraja / Отвертка плоска ударна / Plosnati odvijac za nabijanje / Pļosnati odvijac za zabijanje / Καταβίβι κρούσης επίπεδο / Destornillador plano de golpe / Giravite passante piatto / Chave de fenda plano p. malhar / Tournevis à fourche à frapper / Vlakke slagschroevendraaier

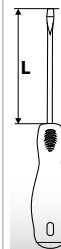
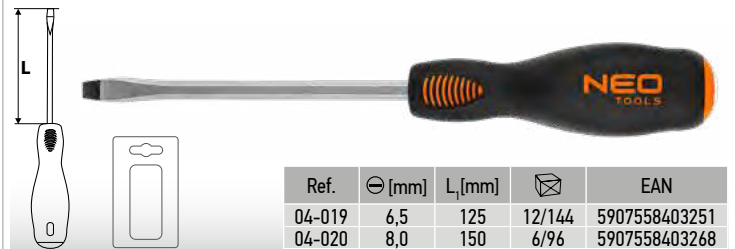

Ref.	⊖ [mm]	L [mm]	📦	EAN
04-019	6,5	125	12/144	5907558403251
04-020	8,0	150	6/96	5907558403268

Wkrętak krzyżowy do pobijania

Screwdriver go through phillips / Kreuzschraubendreher zum Klopfen / Отвертка крестовая усиленная ударная / Відкрутка крестовидна ударна / Csavarhúzó üthető phillips / şurubelnijâ cruciiliță p/u spargere / Šroubovák křížový úderový / Skrutkovač úderový PH sitiena / Ploščati izvijač, udarni / Kryžminis, smūginis atsuktavas / Skrūvgrizis krusta PH sitiena / Ristpeakruvikeeraja / Отвертка / Одвијач / Одвијач / Σταυρωτό καταβίβι τύπου phillips / Destornillador de golpe phillips / Giravite passante Phillips / Chave de fenda de cruzeta p. malhar / Tournevis en croix à frapper / Slagkriusschroevendraaier

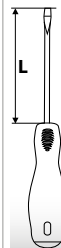

Ref.	⊕	L [mm]	📦	EAN
04-028	PH2	100	12/144	5907558403282

Wkrętaki do pobijania

Go through screwdrivers / Schraubendreher zum Aufheben / Отвертки ударные / Викрутки ударні / Csavarhúzókészlet üthető / Surubelnita de impact / Šroubováky úderové / Sekacie skrutkovače / Izvijači za zabijanje / Smūginiai suktuvai / Triecienskrūvgrieži / Löökkruvikeerajad / Ударни отвертки / Одвијачи за nabijanje / Одвијаче за zabijanje / Καταβίβια κρούσης / Destornilladores de golpe / Set giraviti passante / Chaves de fenda p. malhar / Tournevis à frapper / Slagschroevendraaiers



⊖ 5.5x100mm; 6.5x125mm; 8x150mm
⊕ PH1x75; PH2x100

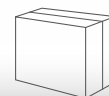

Ref.	📦	EAN
04-240	12/24	5907558412857



Wkręta

Screwdriver set / Schraubendreher / Ομαρτηκι / Відкрутки, набір / Csavarhúzókészlet / Set şurubelişte / Šroubováky / Súprava skrutkovačov / Garnitura izvijačev / Atsuktuvai / Skrūvgriežu komplekts / Kruvikeerajate komplekt / Ομαρτηκι κομпл. / Odivjaci / Odivjac set / Συλλογή από καταβίδια / Destornilladores / Set giraviti / Chaves de fenda / Tournevis / Schroevendraaiers



⊖ 6x125 mm; 5x100 mm; 3x75 mm
 ⊕ PH2x125 mm; PH1x100 mm; PH0x75 mm

Ref.	⊞	EAN
04-213	6/24	5907558432220



⊖ 8x150; 6.5x125; 5.5x100; 6.5x38 mm
 ⊕ PH2x125; PH1x100; PH0x75; H2x38 mm

Ref.	⊞	EAN
04-207	6/12	5907558422177

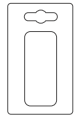

⊖ 5.5x75 mm, 6.5x100 mm
 ⊕ PH1x75 mm, PH2x100 mm

Ref.	⊞	EAN
04-204	6/36	5907558402254



⊖ 6.5x150; 6.5x125; 5.5x100; 3x75 mm
 ⊕ PH2x125, PH1x100; PH0x75 mm

Ref.	⊞	EAN
04-206	6/24	5907558422214



⊖ 4x250 mm, 5.5x250 mm
 ⊕ PH1x250 mm, PH2x250 mm

Ref.	⊞	EAN
04-214	6/24	5907558435627



⊖ 6.5x150 mm; 5.5x100 mm; 3x75 mm; 5.5x38 mm; 6.5x38 mm
 ⊕ PH2x150 mm; PH1x100 mm; PH0x75 mm; PH2x38 mm

Ref.	⊞	EAN
04-208	6/12	5907558422221



Wkrętaki

Screwdriver set / Schraubendreher / Отвертки / Відкртки, набір / Csavarhúzókészlet / Set şurubelnițe / Šroubováky / Súprava skrutkovačov / Garnitura izvijačev / Atsuktuvai / Skrūvgriežu komplekts / Kruvikeerajate komplekt / Отвертки компл. / Odvijači / Odvijac set / Συλλογή από καταβίδια / Destornilladores / Set giraviti / Chaves de fenda / Tournevis / Schroevendraaiers



⊖ 5x250 mm, 4x250 mm
⊕ PH2x250 mm, PH1x250 mm

Ref.	📦	EAN
04-191	6/24	5907558442656

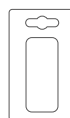

⊖ 3.0x75mm, 5.5x100mm, 6.5x150mm
⊕ PH1x100mm, PH2x150mm

Ref.	📦	EAN
04-192	6/24	5907558442663



⊖ 5.5x38mm, 5.5x100mm, 6.5x150mm
⊕ PH1x100mm, PH2x38mm, PH2x150mm

Ref.	📦	EAN
04-193	6/24	5907558442670



⊖ 2x50mm; 2.4x50mm; 6.5x38mm; 6.5x100mm
⊕ PH0x50mm; PH1x50mm; PH2x100mm; PH2x38mm

Ref.	📦	EAN
04-194	6/24	5907558442687



Wkrętak odwracalny

Reversible screwdriver / Schraubendreher, umwendbar / Отвертка универсальная / Викртка универсальна, з двобічними знімними наконечниками / Csavarhúzókészlet / Surubelniță cu varf dublu, reversibil / Šroubovák oboustranný / Otáčací skrutkovač / Dvosmerni izvijač / Atsuktuvai su keičiamais antgaliais / Universālais skrūvgriežis / Pööratava peaga kruvikeeraja / Универсална отвертка / Povratni odvijač / Povratni odvijac / Καταβίδι γενικής χρήσης / Destornillador reversible / Giravite reversibile / Chave de fenda reversível / Tournevis réversible / Omkeerbare schroevendraaier



⊖ 6x38 mm
⊕ PH2x38 mm

Ref.	📦	EAN
04-201	12/144	5907558402230



Wkrętak z giętkim grotem

Screwdriver with flexible shank with bits / Schraubendreher mit flex. Spitze / Отвертка с гибким стержнем / Відкртка з жалом на шарнірі / Csavarhúzó készlet flexibilis nyéllel / şurubelniță cu corp flexibil cu vîrf / Šroubovák s pružným hrotem / Skrutkovač Flexi+Bity / Izvijač s pregibno konico / Atsuktuvai su lanksčia šerdimi / Skrūvgriežis ar lankano galu uzgalįm / Painduva käepidemeņa kruvikeeraja / Отвертка с Накруйнице / Odvijac / Καταβίδι με εύκαμπτη λαβή και σετ μπιτών / Destornillador con vástago flexible + puntas / Cacciavite con la punta flessibile / Chave de fenda com ponta flexível / Tournevis à pointe douce / Schroevendraaier met zachte eindstuk



⊖ 5, 6, 7 mm
⊕ PH1, PH2, PH3, PZ1, PZ2
⊕ T15, T20

Ref.	📦	EAN
04-212	6/36	5907558402261



Wkrętaki i końcówki wkrętakowe

Screwdrivers and bits / Schraubendreher und Einsätze für Schraubendreher / Отвертки и насадки / Вкрутки и наконечники вкруткови / Csavarhúzó és bitkészlet / Set surubelnița și capete / Šroubováký a šroubovákový nástavec / Skrutkovače a skrutkovacie nástavce / Izvijaiči in nastavki za izvijače / suktuvai ir antgaliai / Skrūvgrieži un to uzgali / Krivikeerajad ja krivikeerajootsakud / Отвертки и наконечники за тях / Odvijači i nastavci za odvijače / Odvijači i nastavci za odvijače / Καταβίδια και καταβιδώματα / Destornilladores y puntas / Set giraviti e inserti / Chaves de fenda e ponteiros de chave de fenda / Tournevis et embouts de tournevis / Schroevendraaiers en schroevendraaiereindstukken



- ⊖ 8x150; 6.5x125; 5.5x100; 3x75; 2.5x50; 3.0x50 mm
- ⊕ PH2x125; PH1x75; PH00x50; PH0x50 mm
- ⊛ T6x50; T7x50; T8x50 mm



4; 5; 6 mm; PH1; PH2; PH3; PZ1; PZ2; PZ3; T10; T15; T20; T25; H4; H5; H6

Ref.	⊠	EAN
04-209	5/10	5907558422207



- ⊖ 8x150; 6.5x100; 5.5x75; 6.5x38; 2.5x40; 3.0x40 mm
- ⊕ PH3x150; PH2x100; PH1x75; PH2x38; PH00x40; PH0x40 mm
- ⊛ T5x40; T6x40; T7x40; T8x40 mm



4; 5; 6 mm; PH1; PH2; PH3; PZ0; PZ1; PZ2; PZ3, T10; T15; T20; T25; T30; T40; H3; H4; H5; H6

Ref.	⊠	EAN
04-210	5/10	5907558422160



- ⊖ 6.5x100mm
- ⊕ PH2x100 mm, PH1x75 mm



4, 5, 6 mm; T10, T15, T20, T25, T27, T30, T40

Ref.	⊠	EAN
04-196	6/24	5907558442694



- ⊖ 6.5x125; 5.5x100; 6.5x38; 2.5x50; 2.0x50 mm
- ⊕ PH2x125; PH2x100; PH1x75; PH2x38; PH00x50; PH0x50 mm
- ⊛ T5x50; T6x50; T7x50; T8x50; T9x50; T10x50 mm



3; 3; 4; 4; 5; 5; 6; 6 mm; PH0; PH0; PH1; PH1; PH2; PH2; PH3; PH3; T10; T10; T15; T15; T20; T20; T25; T25; T27; T27; T30; T30; H2; H2; H2.5; H2.5; H3; H3; H4; H4; H4; H5; H5; H6; H6

Ref.	⊠	EAN
04-211	6/12	5907558422191



- ⊖ 3x75mm, 4x100 mm, 5.5x100mm, 6.5x150mm
- ⊕ PH1x100mm, PH2x150mm



4.5; 6; 7 mm; PH0, PH1, PH2, PH3; T10, T15, T20, T25, T27, T30, T40; H2, H3, H4, H5, H6

Ref.	⊠	EAN
04-197	6/12	5907558442700

Wkrętaki precyzyjne

Precision screwdriver set / Präzisionsschraubendreher / Отвертки прецизионные / Відкрутки прецизійні, набір / Műszerész csavarhúzókészlet / set surubelnițe / Šroubováký jemná mech. / Suprava mikroskrutkovačov / Garnitura natančnih izvijačev / Atsuktuvai tiksliams darbams / Skrūvgrieži komplekts / Täppiskrivikeerajate komplekt / Отвертки компл. / Odvijač / Odvijač set / Συλλογή καταβιδιών ακριβείας / Destornilladores de precisión / Set giraviti di precisione / Chaves de fenda precisas / Tournevis de précision / Fijnschroevendraaiers



- ⊖ 1.5x40 mm, 2.0x40 mm, 2.5x40 mm
- ⊕ PH00x40 mm, PH0x40 mm

Ref.	⊠	EAN
04-225	6/24	5907558402285



Wkrętak precyzyjny płaski

Slotted precision screwdriver / Feinschraubendreher, flach / Отвертка прецизионная шлицевая / Вкрутка прецизијна, пласка / Műszerész csavarhúzó / Surubelnjät de precizie, varf drept / Šroubovák precizní ploché / Precizny plochý skrutkovač / Precizni ploščati izvijač / Atsuktuvas plokščias, torcinis / Precizējošais plakanais skrūvgriezis / Lame peenkruikeeraja / Отвертка плоска прецизна / Precizni plosnati odvijač / Precizni plosnati odvijač / Κατασάβιδο ακριβείας επίπεδο / Destornillador plano de precisión / Giravite di precisione piatto / Chave de fenda precisa plana / Tournevis de précision à fourche / Vlakke fijnschroevendraaier



Ref.	⊖ [mm]	L [mm]	📦	EAN
04-112	2,0	50	12/240	5907558435511
04-113	2,5	50	12/240	5907558435528
04-114	3,0	50	12/240	5907558435535

Wkrętak precyzyjny krzyżowy PH

Cross slotted precision screwdriver / Feinschraubendreher, Kreuz / Отвертка прецизионная крестовидная / Вкрутка прецизијна, хрестовидна / Műszerész csavarhúzó / Surubelnjät de precizie, varf cruce / Šroubovák precizní křížový / Precizny křížový skrutkovač / Križni precizni izvijač / Atsuktuvas precizinis, kryžminis / Precizējošais krustveida skrūvgriezis / Lame ristpeakruivkeeraja / Отвертка прецизна кръстата / Precizni križni odvijač / Precizni kukasti odvijač / Σταυροκατασάβιδο ακριβείας / Destornillador de precisión phillips / Giravite di precisione Phillips / Chave de fenda precisa de cruzeta / Tournevis de précision en croix / Fijnschroevendraaier



Ref.	⊕ [mm]	L [mm]	📦	EAN
04-115	2,0	50	12/240	5907558435511
04-116	2,5	50	12/240	5907558435528
04-117	3,0	50	12/240	5907558435535

Końcówki wkrętakowe precyzyjne z uchwytem

Precision screwdriver bits with holder / Einsätze für Schraubendreher, fein mit Aufnahm / Набор насадок прецизионных с держателем / Насадки вкруткови, прецизијни, з ручијам / Precizios csavarhúzóbetétek tartóval / Set maner si biti, precizie / Šroubovákové nástavce precizní s držadlem / Skrutkovicie nástavce precizne s upínadlom / Nastavki za precizni izvijač z vpenjalom / Atsuktuva antgaliai, preciziniai su laikikliu / Precizējošu uzgaļu komplekts ar turētāju / Peenkruikeerajaotsakud koos käepidemega / Комплект прецизни накрајници за отвертка с држач / Precizni nastavi cza odvijač s hvataljkom / Nastavci za precizni odvijač s drškom / Σετ με κατασάβιδομτες ακριβείας και προσαρμογέα / Puntas destornilladoras de precisión con mango / Inserti di precisione per avvitare con impugnatura / Ponteiros chave de fenda precisos com suporte / Embouts de tournevis de précision avec manche / Fijnschroevendraaierinstukken met handvat



6.3 x 25 mm

3; 4; 5; 6; 7

4; 5; 6; 6.5

T9; T10; T15; T20; T25; T30

H2.5; H3; H4; H5; H6

PZ1; PZ2; PZ3

Y1; Y2; Y3

U6; U8

2.3

R1

4 x 28 mm

1; 1.5; 2; 2.5; 3; 3.5; 4

1; 1.5; 2; 2.5; 3.5

T3; T4; T5; T6; T7; T8; T9; T10; T15; T20

H0.9; H1.3; H1.5; H2; H2.5; H3; H3.5; H4; H4.5; H5; H6

Y2

U2.6

0.8

2; 2.3

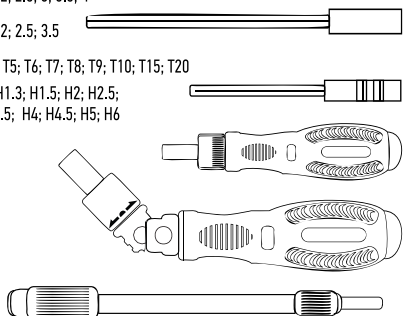

Ref.	📦	EAN
06-115	0/10	5907558431896



6.3 x 25 mm

3; 4; 5; 6; 7

4; 5; 6; 6.5

T9; T10; T15; T20; T25; T30

H2.5; H3; H4; H5; H6

PZ1; PZ2; PZ3

Y1; Y2; Y3

U6; U8

2.3

R1

4 x 28 mm

1; 1.5; 2; 2.5; 3; 3.5; 4

1; 1.5; 2; 2.5; 3.5

T3; T4; T5; T6; T7; T8; T9; T10; T15; T20

H0.9; H1.3; H1.5; H2; H2.5; H3; H3.5; H4; H4.5; H5; H6

Y2

U2.6

0.8

2; 2.3

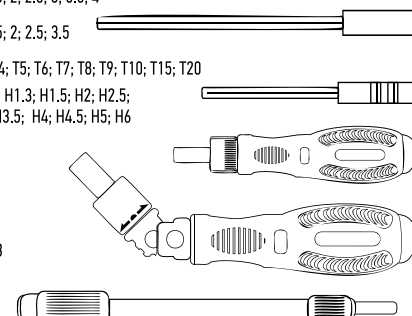

Ref.	📦	EAN
06-116	0/10	5907558431902



Końcówki wkrętaskowe precyzyjne z uchwytem

Precision screwdriver bits with holder / Einsätze für Schraubendreher, fein mit Aufnahme / Набор насадок прецизионных с держателем / Насадки викруткові, прецизійні, з руків'ям / Precíziós csavarhúzóbetétek tartóval / Set maner si biti, precizie / Šroubovákové nástavce precízní s držadlem / Skrutkovacie nástavce precízne s uchytením / Nastavki za precízni izvijač z vpenjalom / Atsuktuvo antgaliai, preciziniai su laikikliu / Precizėjašu uzgaļu komplekts ar turētāju / Peenkrivikeerajaotsakud koos käepidemega / Комплект прецизни накрайниці за отвертка с держач / Precizni nastavi cza odvijač s hvataljkom / Nastavci za precizni odvijač s drškom / Set με καταβιδόμυτες ακριβείας και προαρμογέα / Puntas destornilladoras de precisión con mango / Inserti di precisione per avvitare con impugnatura / Ponteiros chave de fenda precisos com suporte / Embouts de tournevis de précision avec manche / Fijnschroevendraaiereindstukken met handvat

CrV steel PRECISION set x53



- ⬡ 4; 4.5; 5; 5.5; 6; 7 mm
- ⬢ 2.5; 3; 3.5; 4; 4.5; 5; 5.5 mm
- ⊖ 1; 1.5; 2; 2.5; 3; 3.5; 4 mm
- ⊕ 1; 1.5; 2; 2.5; 3.5
- ⊛ T3; T4; T5; T6; T7; T8; T9; T10; T15; T20
- ⊙ H0.9; H1.3; H1.5; H2; H2.5; H3; H3.5; H4
- ⊚ Y0.8; Y2
- ⊛ 2
- ⊛ 0.8
- ⊚ U2.6
- ⊙ SIMIN 0.8
- ⊛ 1.5

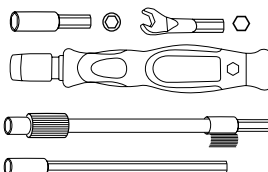

Ref.	⊠	EAN
06-111	20/40	5907558431889



- ⊖ 2.0, 2.5, 3.0 mm
- ⊕ PH00, PH0, PH1, PZ00, PZ0
- ⊛ T6, T7, T8, T9, T10
- ⊙ H1.5, H2.0, H2.5

Ref.	⊠	EAN
04-228	6/36	5907558410068

Szkló powiększające

Magnifying glass / Lupe / Увеличительное стекло / Збільшувальне скло / Nagyító / Vergrößerungsglas / Lupă / Zväčšujúce sklo / Povečevalno steklo / Didinamasis stiklas / Palielinošais stikls / Suurendusklaas / Лупа / Povečalo / Лупа / Μεγεθυντικός φακός / Лупа / Lente d'ingrandimento / Lente de aumento / Loupe / Vergrotingsglas / Magnifying lenses / Vergrößerungslinsen / Увеличительные линзы / Линзи збільшувальні / Nagyító lencsék / Lentile de mărire / Zvětšovací čočky / Zväčšujúce šošovky / Povečevalne leče / Didinamiēji lēšiai / Palielinošās lēcas / Suurendusklaasid / Увеличительни леци / Povečale leče / Повећала сочива / Μεγεθυντικοί φακοί / Lentes de aumento / Lenti d'ingrandimento / Lentes de aumento / Lentilles grossissantes / Vergrotende lenzen

3xLED light DPT 2.5x 110 mm DPT 4x 20 mm DPT 25x 20 mm X3 AAA



Ref.	⊠	EAN
06-129	10/80	5907558444810

Soczewki powiększające

Magnifying lenses / Vergrößerungslinsen / Увеличительные линзы / Линзи збільшувальні / Nagyító lencsék / Lentile de mărire / Zvětšovací čočky / Zväčšujúce šošovky / Povečevalne leče / Didinamiēji lēšiai / Palielinošās lēcas / Suurendusklaasid / Увеличительни леци / Povečale leče / Повећала сочива / Μεγεθυντικοί φακοί / Lentes de aumento / Lenti d'ingrandimento / Lentes de aumento / Lentilles grossissantes / Vergrotende lenzen



2xLED light DPT 10x, 15x, 20x, 25x, 35x X2 AAA

Ref.	⊠	EAN
06-130	0/40	5907558444827

Zestaw otwieraków

Opener set / Öffner-Satz / Открывалки набор / Набор інструменту для розкладання / Szétválasztó készlet / Set deschizătoare / Súprava otváračov / Sada otváracích nástrojů / Set odpiral / Atidarymo komplektas / Atvērēju komplekts / Avaja komplekt / Комплект отварачки / Set otvarača / Отварач сет / Set ανοιχτήρι / Juego de abridor / Leve di separazione / Conjunto abridor / Jeu d'ouvreurs / Opener set

ANTI STATIC x13

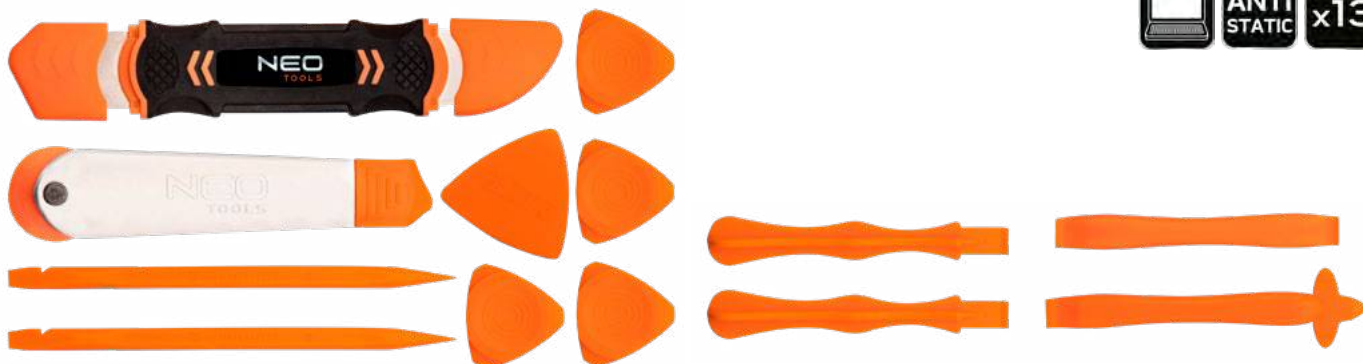

Ref.	⊠	EAN
06-127	60/120	5907558444797



Końcówki wkrętekowe z uchwytem

Screwdriver bits with holder / Einsätze für Schraubendreher mit Aufnahme / Набор насадок с держателем / Наконечники викруткові, з рукояттям / Csavarhúzó cserélhető fejjű / Set biti cu suport capat / Šroubovákové nástavce s držadlem / Skrutkovacie nástavce s upínadlom / Nastavki za izvijač z vpenjalom / Atsuktivo antgalai su laikikliu / Skruvgrieža uzgaļu komplekts ar turētāju / Krūvikeerajaotsakud koos käepidemega / Накрайниці за отвертка с держач / Nastavci za odvijač s hvataljkom / Nastavci za odvijač s drškom / Σετ με καταβίβιομτες και προαρμυγέα / Puntas destornilladoras con mango / Set inserti con supporto / Ponteiros Chave de fenda com Suporte / Embouts de tournevis de précision avec manche / Schroevendraaiereinstukken met handvat

25 years GUARANTEE

TÜVRheinland CERTIFIED

SUPER HARD S2 steel

x99

1/4"



- ⊖ 3, 4, 4.5, 5.5, 6, 6.5, 7, 8 mm
- ⊕ PH0, PH1, PH2x5, PH3
- ⊕ PZ0, PZ1x2, PZ2x5, PZ3
- ⊕ T8, T10, T15, T20, T25, T27, T30, T40
- ⊕ TT8, TT10, TT15, TT20, TT25, TT27, TT30, TT35, TT40
- H1.5, H2, H2.5, H3, H4, H5, H5.5, H6, H8
- H1/16, H5/64, H3/32, H7/64, H1/8, H9/64, H5/32, H3/16, H7/32, H1/4"
- HT2, HT2.5, HT3, HT4, HT5, HT6
- 5/64, 3/32, 7/64, 1/8, 9/64, 5/32"
- M5, M6, M8
- ⊕ 4, 6, 8, 10 mm
- ⊕ 2, 3, 4 mm
- ⊖ 1, 2, 3 mm
- ⊖ 6, 8, 10 mm
- No0, No1, No2, No3

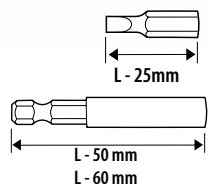

Ref.	⊠	EAN
06-104	6/24	5907558406245

25 years GUARANTEE

TÜVRheinland CERTIFIED

SUPER HARD S2 steel

x38

1/4"

48



- ⊖ 3, 4, 5, 6 mm
- ⊕ PH1x2, PH2x2, PH3x2
- ⊕ PZ1x2, PZ2x2, PZ3x3
- ⊕ T10, T15, T20, T25, T27, T30, T40
- ⊕ TT10, TT15, TT20, TT25, TT27, TT30, TT40
- H2, H2.5, H3, H4, H5, H6

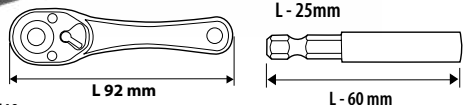

Ref.	⊠	EAN
06-105	6/36	5907558402315

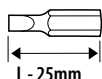
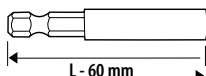

25 years GUARANTEE

TÜVRheinland CERTIFIED

SUPER HARD S2 steel

1/4"

x31



- ⊖ 3, 4, 5, 6 mm
- ⊕ PH1, 2xPH2, PH3
- ⊕ PZ1, 2xPZ2, PZ3
- H3, H4, H5, H6
- ⊕ T10, T15, T20, T25, T27, T30, T40
- ⊕ TT10, TT15, TT20, TT25, TT27, TT30, TT40

Ref.	⊠	EAN
06-103	6/24	5907558402346

25 years GUARANTEE

TÜVRheinland CERTIFIED

SUPER HARD S2 steel

1/4"

x32

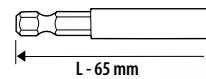
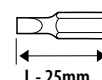

- ⊖ 3, 4, 5, 6 mm
- ⊕ PH1, 2xPH2, PH3
- ⊕ PZ1, 2xPZ2, PZ3
- H3, H4, H5, H6
- ⊕ T10, T15, T20, T25, T27, T30, T40
- ⊕ TT10, TT15, TT20, TT25, TT27, TT30, TT40

Ref.	⊠	EAN
06-106	12/48	5907558410143

25 years GUARANTEE

TÜVRheinland CERTIFIED

SUPER HARD S2 steel

x7

1/4"

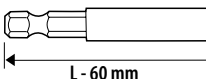
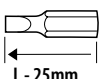

- ⊖ 4, 5, 6 mm
- ⊕ PH1, PH2
- ⊕ T15, T20

Ref.	⊠	EAN
06-101	12/120	5907558402339



Uchwyt do końcówek

Bit holder / Aufnahme für Spitzen / Зажим для наконечников / Тримач до наконечників / Csavarbehajtószer / Dispositiv de prinderea capetelor / Skličadlo na nástavce / Upínadlo na nástavce / Vpenjalo za nastavke / Laikiklis antgaliams / uzgāju patrona / Otsakupadrin / Държач за накрайници / držka za nastavke / Hvat za nastavke / Προσαρμογέας μπιτών / Mandril de sujeción para puntas / Innesto per inserti con impugnatura / Suporte de ponteiros / Manche pour embouts / Houder voor eindstukken

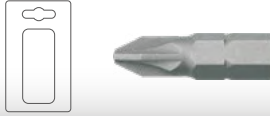
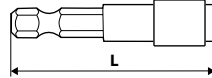

Ref.	L [mm]	⊗	EAN
06-070	65	10/100	5907558403497



Ref.	L[mm]	L ₁ [mm]	⊗	EAN
06-078	215	100	12/180	5907558414417

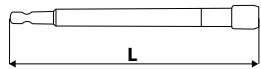

Ref.	L[mm]	⊗	EAN
06-072	150	12/96	5907558410105
06-073	300	12/48	5907558410112

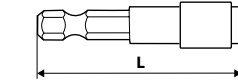

Ref.	L [mm]	⊗	EAN
06-071	60	20/200	5907558405385



Końcówki wkrętakowe

Driver bits / Einsätze für Schraubendreher / Насадки / Наконечники викретоми / Csavarhúzó hegyek / Set biti / Šroubovákové nástavce / Skrutkovacie nástavce / Nastavki za izvijače / Atsuktuvo antgaliai / Skrūvgrieža uzgāļi / Kruvikeerajotsakud / Накрайници за отвертка / Nastavci za odvijač / Nastavci za odvijač / Καταβιβόμενες / Puntas destornilladoras / Inserti / Ponteiros de chave de fenda / Embouts de tournevis / Schroevendraaier eindstukken

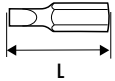

Ref.	⊕	L[mm]	⊗	EAN
06-011	PH2	25	12/120	5907558406351

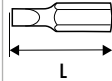

Ref.	⊕	L[mm]	N	⊗	EAN
06-020	PZ2	25	x20	50/150	5907558403015

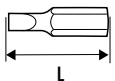

Ref.	⊕	L[mm]	N	⊗	EAN
06-036	PH2	25	x10	50/150	5907558403121
06-037	PH2	50	x5	50/200	5907558403138



Ref.	⊕	⊗	EAN
06-040	PH2	24/192	5907558410099



Szpikulec

Point chisel / Spicknadel / Наконечник / Шило / Ár / Tijä ascuțită / Hrot / Šidlo / Igla za pretikanje / Yla / Caurumsitis / Naaskel / Шило / Šiljak / Probačač, šilo / Μύτη / Púa / Punteruolo / Ponta / Pointe / Puntbeitel



Ref.	📦	EAN
04-037	12/120	5907558435917

Haki

Hooks / Hacken / Крюки / Гаки / Horgok / Cârlige / Háky / Skoby / Kljčke / Kablrai / Āķi / Haagid / Кюки / Kuke / Kuke / Γάντζοι / Ganchos / Ganci / Anzóis / Crochets / Haken



Ref.	📦	EAN
04-231	6/72	5907558483901

Wkrętarz udarowy

Impact screwdriver / Schlag-Schraubendreher / Отвертка ударная / Викрутка ударна / Ütvecsavarozó / Surubelnija cu percutor / Šroubovák rázový / Rázový skrutkovač / Udarni izvijač / Smūginis suktuvas / Trieciens skrūvgrēzis / Löökkruvikeeraja / Ударна отвертка / Odvijač s udarom / Udarni odvijač / Καταβίβι κρούσης / Destornillador de impacto / Cacciavite a percussione / Chave de fenda de impacto / Tournevis à chocs / Slagschroevendraaier



⊖ 5, 6, 8, 10, 12, 14 mm
⊕ PH1, PH2, PH3

1/2" → 5/16"

Ref.	m[kg]	📦	EAN
04-250	1,2	0/12	5907558410082

Wkrętarz akumulatorowy

Cordless Screwdriver / Akku-Schraubendreher / Отвертка аккумуляторная / Шрубверт аккумуляторний / Akkumulátoros csavarozó / Surubelnija cu acumulator / Akumulátorový šroubovák / Akumulátorový skrutkovač / Akumulatorski vijačnik / Akumulatorinis suktuvas / Akumulatora skrūvgrēzis / Akukruvikeeraja / Аккумуляторна отвертка / Akumulatorski odvijač / Akumulatorski odvijač / Εναρφορτιζόμενο καταβίβι / Destornillador a batería / Avvitatore a batteria / Chave de fenda de bateria / Tournevis à batteries / Accu schroevendraaier



Ref.	📦	EAN
04-200	0/16	5907558439380



Wkrętak płaski 1000V

Screwdriver slotted / Flachsraubendreher / Отвертка плоская / Відкрітка плоска / Csavarhúzó / şurubeliňiä platä / Šroubovák plochý / Skrutkovač plochý / Ploščati izvijač / Ploščias atsuktuvas / Skrūvgriezis plakans / Lamepea-kruvikeeraja / Отвертка / Odvijač / Odvijac / Καταβίδι εκροής / Destornillador plano / Giravite piatto 1000V / Chave de fenda plana / Tournevis à fourche / Vlakke schroevendraaier



Ref.	⌀ mm	L[mm]	L ₁ [mm]	⊠	EAN
04-051	2,5	150	75	12/600	5907558401998
04-052	3,0	175	100	12/240	5907558402001
04-053	4,0	205	100	12/240	5907558402018
04-054	5,5	230	125	12/144	5907558402025
04-055	6,5	270	150	12/144	5907558402032

Ref.	⌀ mm	L[mm]	L ₁ [mm]	⊠	EAN
04-130	0.4	175	75	12/120	5907558433227
04-131	0.6	195	100	12/120	5907558433234
04-132	0.8	198	100	12/120	5907558433241
04-133	1.0	230	125	12/120	5907558433258

Wkrętak krzyżowy PH 1000V

Screwdriver Phillips / Kreuzschraubendreher / Отвертка крестовая / Відкрітка хрестовидна / Csavarhúzó philips / şurubeliňiä tip „Phillips” / Šroubovák křížový / Skrutkovač PH / Křížni izvijač / Kryžminis atsuktuvas Phillips / Skrūvgriezis krusta PH / Ristpeakruvikeeraja / Отвертка / Odvijač / Odvijac / Καταβίδι σταυρωτά τύπου philips / Destornillador philips / Giravite Phillips / Chave de fenda de cruzeta / Tournevis en croix / Kriusschroevendraaier



Ref.	⊕	L[mm]	L ₁ [mm]	⊠	EAN
04-071	PH0	135	60	12/600	5907558402070
04-072	PH1	190	80	12/240	5907558402087
04-073	PH2	215	100	12/144	5907558402094

Ref.	⊕	L[mm]	L ₁ [mm]	⊠	EAN
04-137	PH0	160	60	12/120	5907558433296
04-138	PH1	185	80	12/120	5907558433303
04-139	PH2	210	100	12/120	5907558433319
04-140	PH2	285	175	12/120	5907558433326

Wkrętak krzyżowy PZ 1000V

Screwdriver Pozidriv / Kreuzschraubendreher / Отвертка крестовая / Відкрітка хрестовидна / Csavarhúzó pozidriv / şurubeliňiä tip „Pozidriv” / Šroubovák křížový / Skrutkovač PZ / Křížni izvijač / Kryžminis atsuktuvas Phillips / Skrūvgriezis krusta PZ / Ristpeakruvikeeraja Pozidriv / Отвертка / Odvijač / Odvijac / Καταβίδι τύπου pozidriv / Destornillador philips / Giravite Pozzi 1000V / Chave de fenda de cruzeta / Tournevis en croix / Kriusschroevendraaier



Ref.	⊕	L[mm]	L ₁ [mm]	⊠	EAN
04-062	PZ1	190	80	12/240	5907558402056
04-063	PZ2	217	100	12/144	5907558402063

Ref.	⊕	L[mm]	L ₁ [mm]	⊠	EAN
04-136	PZ2	210	100	12/120	5907558433289

Wkrętaki 1000V

Screwdriver set / Schraubendreher / Отвертки / Відкрітки, набір / Csavarhúzókészlet / set şurubeliňiä / Šroubováky / Súprava skrutkovačov-bity / Komplet izvijačev / Atsuktuvų komplektas / Skrūvgriežu komplekts / Kruvikeerajate komplekt / Отвертки компл. / Odvijač / Odvijac set / Συλλογή καταβιδιών / Destornilladores / Set giraviti 1000V / Chaves de fenda / Tournevis / Schroevendraaiers

- ⌀ 2.5x75 mm, 4x100 mm, 6.5x150 mm
- ⊕ PH1x80 mm, PH2x100 mm

- ⌀ 3x100 mm, 4x100 mm, 5.5x125 mm, 6.5x150 mm, 8x175 mm
- ⊕ PH0x60mm, PH1x80 mm, PH2x100 mm, PH3x150 mm

Ref.	⊠	EAN
04-220	6/36	5907558402278

Ref.	⊠	EAN
04-143	0/12	5907558433357



Wkrętaki 1000V

Screwdriver set / Schraubendreher / Отвертки / Відкрітки, набір / Csavarhúzókészlet / set şurubelişte / Šroubováky / Súprava skrutkovačov/bity / Komplet izvijačev / Atsuktuvų komplektas / Skrivgræzių kompleks / Kruvikeerajate komplekt / Отвертки компл. / Одвијач / Одвијас / Συλλογή κατασβιδιών / Destornilladores / Set giraviti 1000V / Chaves de fenda / Tournevis / Schroevendraaiers



- 0.6x100mm, 0.8x100mm, 1.0x100mm, 1.2x100mm, 1.6x175mm
- PH0x60 mm, PH1x80 mm, PH2x100 mm, PH3x150 mm



Ref.	☒	EAN
04-142	0/12	5907558433340

Wkrętak plus-minus 1000V

Screwdriver / Kreuzschraubendreher / Отвертка крестовая / Відкрітка хрестовидна / Csavarhúzó / şurubelişte / Šroubovák křížový / Skrutkovač / Křížní izvijač / Kryžminis atsuktuvus / Skrivgræzis krusta / Ristpeakruvikeeraja / Отвертка / Одвијач / Одвијас / Κατασβίδι σταυρωτό τύπου / Destornillador phillips / Giravite / Chave de fenda de cruzeta / Tournevis en croix / Kriusschroevendraaier



Ref.	☒	☒	L[mm]	L ₁ [mm]	☒	EAN
04-221	SL/PZ2		220	100	12/144	5907558432398
04-222	SL/PH2		220	100	12/144	5907558432404

Konektory

Electric connectors set / Steckverbinder-Set / Коннекторы набор / Коннектори, набір / Kábelsarukészlet / Conectori set / Konektory súprava / Konektory / Komplet električnih priključkov / Elektros jungčių rinkinys / Elektrisko savienotāju komplekts / Elektripistikute komplekt / Комплект електрически съединители / Komplet električnih konektora / Комплект електричних конектора / Set ηλεκτρικών συνδετήρων / Juego de conectores eléctricos / Set di connettori / Conjunto de conectores eléctricos / Jeu de connecteurs électriques / Elektrische connectoren set



x15 6.3 mm 11-10 AWG 4.0-6.0 mm ²	x15 6.3 mm 11-10 AWG 4.0-6.0 mm ²	x30 4.8 mm 20-17 AWG 0.5-1.0 mm ²	x30 4.8 mm 20-17 AWG 0.5-1.0 mm ²	x50 2.8 mm 20-17 AWG 0.5-1.0 mm ²	x50 2.8 mm 20-17 AWG 0.5-1.0 mm ²
x15 M10 20-17 AWG 0.5-1.0 mm ²	x15 M8 20-17 AWG 0.5-1.0 mm ²	x20 M5 20-17 AWG 0.5-1.0 mm ²	x30 4.0 mm 20-17 AWG 0.5-1.0 mm ²	x15 4.0 mm 20-17 AWG 0.5-1.0 mm ²	x15 4.0 mm 20-17 AWG 0.5-1.0 mm ²
x15 M10 15-13 AWG 1.5-2.5 mm ²	x15 M8 15-13 AWG 1.5-2.5 mm ²	x20 M5 15-13 AWG 1.5-2.5 mm ²	x30 4.8 mm 15-13 AWG 1.5-2.5 mm ²	x30 4.8 mm 15-13 AWG 1.5-2.5 mm ²	x10 6.3 mm 15-13 AWG 1.5-2.5 mm ²

Ref.	☒	EAN
01-535	0/36	5907558439366

Końcówki wkrętakowe z uchwytem 1000V

Screwdriver bits with holder / Einsätze für Schraubendreher mit Aufnahme / Набор насадок с держателем / Наконечники викруткаві, з ручієм / Csavarhúzó cserélhető fejű / Set biti cu suport carpat / Šroubovákové nástavce s držadlem / Skrutkovačie nástavce s upínadlom / Nastavki za izvijač z vpenjalom / Atsuktuvų antgaliai su laikikliu / Skrivgræziæa uzgaļu kompleks ar turētāju / Kruvikeerajajotsakud koos käepidemega / Накарайніцы за отвертка с държач / Nastavci za odvijac s hvataljkom / Nastavci za odvijac s drškom / Σετ με κατασβιδόμετες και προσαρμογέα / Puntas destornilladoras con mango / Set inserti con supporto / Ponteiros Chave de fenda com Suporte / Embouts de tournevis de précision avec manche / Schroevendraaiereindstukken met handvat



- 1000V, 100mm
- SL: 2.0, 2.5, 3.0, 3.5, 4.0, 5.5, 6.5
- PH: 0, 1, 2



QUICK CHANGE



Ref.	☒	EAN
01-308	0/20	5907558435597



- 1000V, 100mm
- SL: 2.0 / 2.5 / 3.0 / 3.5 / 4.0 / 5.5 / 6.5
- PH: PH0 / PH1 / PH2
- PZ: PZ0 / PZ1 / PZ2
- T: T6 / T8 / T9 / T10 / T15 / T20 / T25 / T27 / T30
- H: H2.5 / H3.0 / H4.0 / H5.0 / H6.0
- R: R1 / R2
- TRI: TRI 1 / TRI 2 / TRI 3 / TRI 4
- TORO: TORO 4 / TORO 6 / TORO 8 / TORO 10
- M: M4 / M5 / M6
- U: U4 / U6 / U8 / U10

- 1000V, 89mm
- 6.3 / 8.1



QUICK CHANGE



Ref.	☒	EAN
01-309	0/10	5907558435603

Grzechotka 1000V

Ratchet handle / Ratsche / Трещотка / Держак з трісчоткою / Racsnikulcs / Miner de hurluitoare / Řehtačka / Račňa prepínacia / Raglja / Terkslë / Reversa atslëga / Pörkratta pide / Трещотка / Račva za nasadni ključ / Račva za gedoru / Κατασβίδι / Llave de carraca / Cricchetto / Catraca de furar / Clé à cliquet / Ratel



Ref.	☒	EAN
01-180	4/28	5907558432817



Nasadka sześciokątna 1000V

Hexagonal socket / Sechskanteinsatz / Головка сменная шестигранная / Насадка шестигранная / Dugókulcs / Cheie tubulara hexagonală / Šestihranný nástavec / Šesthranný nástavec / Šestkotni natčni nastavek / Šešakampis antgalis / Sešstūra nomaināmo galva / Kuuskantpadrun / Шестозъелна наставка / Šesterokutna kapica / Šestougaona nasadka / Καρδάνκι εξάγωνο / Vaso para destornillador hexagonal / Bussola esagonale / Bocal hexagonal / Douille à 6 pans / Zeskant dop

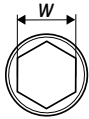

Ref.	W[mm]	☒	EAN	Ref.	W[mm]	☒	EAN
01-181	10	12/108	5907558432893	01-188	18	12/108	5907558432961
01-182	11	12/108	5907558432909	01-189	19	12/108	5907558432978
01-183	12	12/108	5907558432916	01-190	21	11/110	5907558432985
01-184	13	12/108	5907558432923	01-191	22	11/110	5907558432992
01-185	14	12/108	5907558432930	01-192	24	11/110	5907558433005
01-186	16	12/108	5907558432947	01-193	27	15/105	5907558433012
01-187	17	12/108	5907558432954	01-194	30	10/90	5907558433029
				01-195	32	10/90	5907558433036

Klucze sześciokątne 1000V

Hex key / Sechskantschlüssel / Ключи шестигранные / Ключ шестигранный / Imbuskulcs készlet / Set chei cu șase laturi / Šestihranný klič / Súprava imbus klíčův (dlhé) / Garnitura inbus kličův / Šešakampių raktų komplektas / Seškanšu atslēgu komplekts / Kuuskant-mutrivõtmete komplekt / Лумбуси компн. / Kličův imbus set / Kličův imbus set / Συλλογή εξαγωνικών κλειδιών / Llaves Allen / Chiavi esagonali / Chaves hexagonais / Clefs à 6 pans / Zeskantsleutels

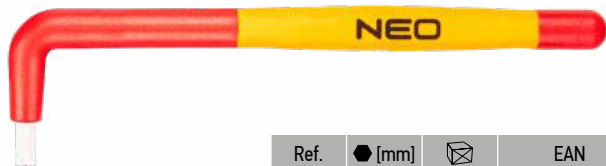

Ref.	● [mm]	☒	EAN
01-171	3	8/72	5907558432824
01-172	4	8/72	5907558432831
01-173	5	6/72	5907558432848
01-175	8	8/48	5907558432862
01-176	10	8/48	5907558432879
01-177	12	6/36	5907558432886

Klucz płaski jednostronny 1000V

Open single end spanner / Maulschlüssel einseitig / Ключ рожковый односторонний / Ключ ріжковий / Villáskulcs / Cheie piulită unilaterală cu cavitatea deschisă / Plochý klič jednostranný / Kličův vidlicový jednostranný / Viličasti kličův / Ploščias vienpusis raktas / Ragatslēga / Ūhe avatud otsaga vōti / Ключ Гаечен / Kličův vilyškasti / Kličův vilyškasti / Μονό γεμανικό κλειδί / Llave fija de una boca / Chiave a forchetta / Chave plana / Clef à fourche simple / Eenzijdig vlakke sleutel

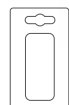

Ref.	● [mm]	☒	EAN	Ref.	● [mm]	☒	EAN
01-110	6	9/108	5907558432411	01-119	15	8/72	5907558432503
01-111	7	9/108	5907558432428	01-120	16	8/72	5907558432510
01-112	8	9/108	5907558432435	01-122	18	8/72	5907558432534
01-113	9	9/108	5907558432442	01-123	19	8/72	5907558432541
01-114	10	9/108	5907558432459	01-124	21	6/54	5907558432558
01-115	11	9/108	5907558432466	01-125	22	6/54	5907558432565
01-116	12	9/108	5907558432473	01-126	24	6/54	5907558432572
01-117	13	9/108	5907558432480	01-127	27	6/36	5907558432589
01-118	14	8/72	5907558432497	01-128	30	6/36	5907558432596
				01-129	32	6/36	5907558432602

Klucze nasadowe 1000V

Socket wrenches / Steckschlüssel / Набор сменных головок / Ключи торцевые / Dugókulcskészlet / Trusa tubulară / Nástrčné kličů / Nástrčné kličů / Nasadni kličůvi / Veržlerakcio antgaliai / Nomaināmo galvu komplekts / Padrunvõtmed / Сменная наконечники за ключом / Nasadni kličůvi / Kličůvi natikači / Σετ με καρδάνια / Llaves de vaso / Set di bussola SuperLock / Chaves tubulares / Clefs à douilles / Dopsleutels



19 elements

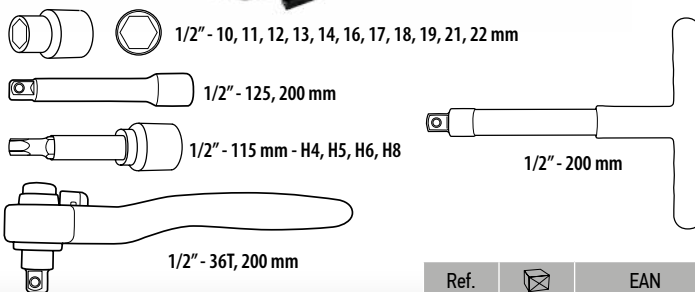

Ref.	☒	EAN
01-306	0/3	5907558435573



8 elements

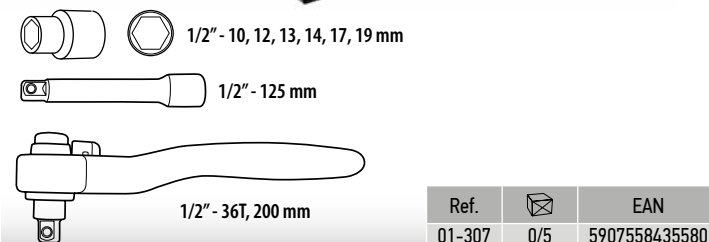

Ref.	☒	EAN
01-307	0/5	5907558435580



Skrzynia serwisowa elektryka 52 szt.

Electrician's tool box 52 pcs / Servicekasten für Elektriker 52-teilig / Инструментальный ящик электрика 52 шт. / Инструментальный ящик электрика 52 шт. / Villanyszerelő koffer, 52 db / Cutie scule electrician 52 piese / Elektrikářský servisní box 52 ks / Elektrikářska skrinka s náradím 52 ks / Servisni kovček elektrikařja 52 kos. / Irankiü deže elektrikiui 52 vnt. / Elektriķa instrumentu kaste 52 gab. / Elektriku tööriistakast 52 tk / Куфар с инструменти за електротехник 52 бр. / Servisni ormar za električare 52 kom. / Servisna kutija električara 52 kom. / Βαλίτσα εργαλείων ηλεκτρολόγου 52 τμχ / Caja de servicio de eléctrico 52 uds. / Casseta portautensili per elettricista 52 pz. / Kit de 52 ferramentas de electricista em caixa / Caisse à outil électricien / Gereedschapkoffer van elektricien 52 st.

160 mm 160 mm 160 mm

180 mm 200 mm

1/2" - 10 / 11 / 12 / 13 / 14 / 16 / 17 / 1 / 8 / 19 / 21 / 22 / 24 / 27 mm

1/2", 115 mm - H4 / H5 / H6 / H8

1/2" - 125 / 250 mm

1/2", 367, 230 mm

195mm

250 V, 3x140mm CE

PH0x60, PH1x80, PH2x100, PH3x150
2.5x75mm, 3x100mm, 4x100mm, 5.5x125mm, 6.5x150mm

8, 10, 11, 12, 13, 14, 15, 16, 17, 18, 19, 22, 24 mm

210 mm, Ra 30 mm

25 years GUARANTEE

CrV steel

S2 steel

1000V

PP POLYPROPYLEN

EVA

DUST / **WATER**

IP67

x52

1/2"

36

52 elements

Ref.	☒	EAN
01-311	0/1	5907558439991

Walizka elektryka

Electrician's suitcase / Elektriker-Koffer / Чемодан электрика / Valiza elektriķa / Villanyszerelő koffer / Valiza electricianului / Kufr elektrikaře / Elektrikářský kufrík / Kovček za električarje / Lagaminas elektrikiui / Elektriķa instrumentu koferis / Elektriku kohver / Куфарче на електротехник / Kovčeg za električare / Kofer električara / Βαλίτσα εργαλείων ηλεκτρολόγου / Maletin de eléctrico / Valigetta da elettricista / Mala de electricista / Malette à outils pour électricien / Gereedschapstas elektricien

S2 steel

CrV steel

CrMo steel

1000V

ABS

TPR

1/4"

1/2"

72

x108

1/2" - 15-16-17-19-20-21-22-24-27-30-32 mm

1/4" - 4-4.5-5-5.5-6-7-8-9-10-11-12-13-14 mm

1/2" - E20-E22-E24

3/8" - E10-E11-E12-E14-E16-E18

1/4" - E4-E5-E6-E7-E8

1/2" - 72T

1/4" - 72T

3/8"x1/2"

1/2"x3/8"

1/2"x5/16"

1/2" - 125, 250 mm

1/4" - 50, 100 mm

1/2" - 16, 21 mm

1/4" - 115 mm

1/4" - 150 mm

1000V

SL 5.5x125, SL 3x100mm

PH0x60mm, PH1x80mm

PH2x100mm

250 V CE

160 mm

1000V, 160 mm

1000V, 160 mm

190 mm

0,34-6 mm²

0,25-6 mm²

0,5-6 mm²

0,5-16 mm²

108 elements

Ref.	☒	EAN
01-310	0/2	5907558431957



Szczypce uniwersalne

Combination pliers / Kombizange / Пассатижи / Пасатижи / Kombinált fogó / clește universal / Kombinované kleště / Kliešte kombinované / Kombinirane klešče / Universalios replės / Plakanknaibles kombinētās / Universaalnripsad / Клеци комбинирани / Kombinirana klijesta / Kombinovana klesta / Πένσα γενικής χρήσης / Alicates universales / Pinza universale / Pinças universais / Pince universelle / Universele tang



Ref.	L[mm]	⊠	EAN
01-010	160	6/48	5907558401547
01-011	180	6/48	5907558401554
01-012	200	6/48	5907558401561

Szczypce wydłużone proste

Combination pliers / Kombizange / Пассатижи / Пасатижи / Hosszúcsőrű fogó / clește universal / Kombinované kleště / Kliešte kombinované / Kombinirane klešče / Universalios replės / Plakanknaibles kombinētās / Universaalnripsad / Клеци комбинирани / Kombinirana klijesta / Kombinovana klesta / Πένσα γενικής χρήσης / Alicates universales / Pinza a becco lungo / Pinças retas prolongadas / Pince allongée droite / Lange rechte tang



Ref.	L[mm]	⊠	EAN
01-013	160	6/48	5907558401578
01-014	200	6/48	5907558401585



Ref.	L[mm]	⊠	EAN
01-250	160	6/60	5907558443646
01-251	180	6/60	5907558443653



Ref.	L[mm]	⊠	EAN
01-252	160	6/60	5907558443660
01-253	180	6/60	5907558443677

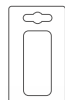

Ref.	L[mm]	⊠	EAN
01-152	180	6/48	5907558448511
01-153	200	6/48	5907558448528

budowa głowicy oszczędza 40% siły przy standardowym nacisku
head design saves 40% of force with standard pressure
конструкция напору экономит 40% усилия при стандартном тиску

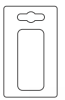

Ref.	L[mm]	⊠	EAN
01-154	160	6/48	5907558448535
01-155	200	6/48	5907558448542

budowa głowicy oszczędza 40% siły przy standardowym nacisku
head design saves 40% of force with standard pressure
конструкция напору экономит 40% усилия при стандартном тиску

Szczypce wydłużone wygięte

Long nose bent pliers / Zange lang, gebogen / Плоскогубцы удлиненные изогнутые / Щипци видовожени, вигнути / Rövidcsőrű fogó / Clește varf ascuțit indoit / Kleště prodloužené vyhnuté / Kliešte predĺžené vyhnuté / Koničaste klešče - upognjene / Prailgintos replės, lenktos / Izliektas pagarinātas knaibles / Pikkade kõverate otstega nāpitsad / Клеци удължени огънати / Izdužena savinuta klijesta / Izdužena uvijena klešta / Μυροταιμπό κυρτό / Alicates Teléfono curvo / Pinza a becco curvo / Pinças curvadas prolongadas / Pince allongée coudées / Lange gebogen tang



Ref.	L[mm]	⊠	EAN
01-015	160	6/48	5907558401592
01-016	200	6/48	5907558401608

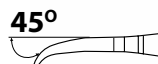

Ref.	L[mm]	⊠	EAN
01-254	160	6/60	5907558443684
01-255	180	6/60	5907558443691



Szczypce boczne

Diagonal cutting pliers / Seitenzange / Бокорезы / Бокорізи / Oldalsípó fogó / clește ascuțit diagonal de tăiat sîrmă / Bočni kleště / Cvikačky bočné / Stranske klešče / Šoninės replės / Sänknaibles / Diagonaal-löiketangid / Клеци Рєзачки / Klijesta cvikerice / Klesta poluokrugla / Πλαγιοκόφτης / Alicates diagonales / Tronchese laterale / Pinças laterais / Pince latérale / Zijtang



Ref.	L[mm]	☒	EAN
01-017	160	6/48	5907558401615
01-018	180	6/48	5907558401622



Ref.	L[mm]	☒	EAN
01-256	160	6/60	5907558443707
01-257	180	6/60	5907558443714



Ref.	L[mm]	☒	EAN
01-156	160	6/48	5907558448559
01-157	180	6/48	5907558448566



Ref.	L[mm]	☒	EAN
01-158	180	6/48	5907558448573

budowa głowicy oszczędza 40% siły przy standardowym nacisku
head design saves 40% of force with standard pressure
конструкция напору экономит 40% зусилля при стандартном тиску

budowa głowicy oszczędza 40% siły przy standardowym nacisku
head design saves 40% of force with standard pressure
конструкция напору экономит 40% зусилля при стандартном тиску

Szczypce okrągłe

Round nose pliers / Rundzange / Круглозубцы / Кръглозубци / Kerekcsőrű fogó / clește rotund / Kulaté kleště / Kliešte s okrúhluou čelustou / Okrogle klešče / Αρvalios replēs / Αρvalknaibles / Ümarmokk-näpitsad / Клещи Чокни / Klijesta okrugla / Klesta okrugla / Μυτοσίμπιλο με στρογγυλά άρμφοι / Alicates redondos / Pinza a becco tondo / Pinças redondas / Pince ronde / Ronde tang



Ref.	L[mm]	☒	EAN
01-020	160	6/48	5907558401646



Ref.	L[mm]	☒	EAN
01-019	160	6/48	5907558401639

Szczypce precyzyjne płaskie

Precision flat pliers / Präzisionszange flach / Плоскозубцы прецизионные / Плоскозубци прецизійні плоскі / Laposcsőrű fogó / Clește plat / Kleště jemná mechanika / Kliešte ploché mikro / Plaske klešče, precizne / Ploščšios replēs tiksliešis darbams / Plakanknaibles / Täppislamemokk-näpitsad / Клещи чокни / Klijesta plosnata / Klesta pljosnata / Πλατυσίμπιλο ακριβείας γενικής χρήσης / Pinza di precisione a becco piatto / Pinças precisas planas / Pince de précision à fourches / Precisie vlakke tang



Ref.	L[mm]	☒	EAN
01-105	130	6/96	5907558401714

Szczypce precyzyjne czołowe

Precision end cutter pliers / Stirnpräzisionszange / Кусячки торцевые прецизионные / Бокорізи прецизійні / Homlokcsípó fogó / clește frontal / Lkleště čelní jemná mechanika / Cvikačky čelné mikro / Stranske klešče, precizne / Žnyplēs tiksliešis darbams / Knaibles / Täppisnäpitsad otste löikamiseks / Клещи резачки / Klijesta cvikerice / Klesta secice / Εμπροσθοκόφτης ακριβείας / Alicates frontales de precisión / Tenaglia di precisione / Pinças precisas frontais / Pince de précision frontale / Precisie hoofdtang



Ref.	L[mm]	☒	EAN
01-101	115	6/96	5907558401677



Szczypce precyzyjne wydłużone proste

Precise long nose straight pliers / Feinzange, lang, gerade / Плоскозубцы прецизионные удлиненные / Щипцы прецизи́йні, з видовженими, прямими зубками / Hoszsúcsőrű fogó / Cleste precizie-varf lung / Kleště precizní prodloužené rovné / Kliešte precízne predĺžené rovné / Precizne ravne podaljšane kleščice / Prailgintos precizinės replės, tiesios / Pagarinātas precizējošas plakanknaibles / Pikkade otstega peennäpitsad / Прецизну удължени клещи / Precizna izdužena jednostavna klijesta / Precizna ravna izdužena klešta / Μυτοσίμυδο ακριβείας / Alicates puntas redondas larga / Pinza di precisione a becco lungo / Pinças precisas prolongadas retas / Pince de précision allongée droite / Lange rechte precisie tang



Ref.	L[mm]	⊠	EAN
01-102	130	6/96	5907558401684

Szczypce precyzyjne wydłużone wygięte

Precise long nose bent pliers / Feinzange, lang, gebogen / Плоскозубцы прецизионные удлиненные изогнутые / Щипцы прецизи́йні, з видовженими, вигнутими зубками / Rövidcsőrű fogó / Cleste precizie-varf indoit / Kleště precizní prodloužení vyhnuté / Kliešte precízne predĺžené vyhnuté / Precizne podaljšane upognjene kleščice / Prailgintos precizinės replės, tiesios / Izliektas pagarinātas precizējošas plakanknaibles / Pikkade kõverate otstega peennäpitsad / Прецизну удължени огънати клещи / Precizna izdužena savinuta klijesta / Precizna unijena izdužena klešta / Μυτοσίμυδο ακριβείας κυρτό / Alicates puntas curvas larga / Pinza di precisione a becco curvo / Pinças precisas prolongadas curvadas / Pince de précision allongée coudées / Lange gebogen precisie tang



45°

Ref.	L[mm]	⊠	EAN
01-103	140	6/96	5907558401691

Szczypce precyzyjne boczne

Precision diagonal pliers / Seitenpräzisionszange / Бокорезы прецизионные / Плоскозубці прецизи́йні діагональні / Oldalcsőrű fogó / Cleste diagonal / Kleště boční jemná mechanika / Cvikačky bočné mikro / Čelne kleščice, precizne / Šoninēs replēs tikslīems darbam / Sānknaibles / Diagonaal-täppisnäpitsad / Клещци резачки / Klijesta cvikerice / Klesta secice / Πλαγκοκόφτης ακριβείας / Alicates diagonales de precisión / Tronchese laterale di precisione / Pinças precisas laterais / Pince de précision latérale / Precisie zijtang



Ref.	L[mm]	⊠	EAN
01-106	110	6/96	5907558401721



Ref.	L[mm]	Ø [mm]	⊠	EAN
01-509	140	0,8 - 2,6	10/50	5907558439281

Szczypce czołowe

End cutting pliers / Frontzange / Нусачки торцовые / Щипцы торцеві / Homlokcsőrű fogó / Cleste taiere frontala / Kleště čelní / Kliešte čelné / Čelne kleščice / Kandiklēs / Kniebjamās knaibles / Otsnāpitsad / Клещци челни / Čeona klijesta / Τανάλια / Alicates de corte frontal / Tenaglia / Pinças frontais / Pince frontale / Hoofd tang



Ref.	L[mm]	⊠	EAN
01-021	160	6/48	5907558401653
01-022	200	6/48	5907558401660

Obcegi do gwoździ

Carpenters pincers / Beißzange / Клещци для гвоздеў / Harapó fogó / cleste dulgher / Štípací kleště / Cvikačky čelné / Mizarske kleščice / Znyplēs vinims / Naglu stangas / Puusepa nāpitstangid / Клещци керпеден / Stolarska Klijesta / Stolarska klesta / Τανάλια Μαραγκού / Tenazas para clavos / Tenaglia da carpentiere / Turqueses p. Pregos / Tenailles à clous / Spijkertang



Ref.	L[mm]	⊠	EAN
01-151	180	6/48	5907558411720
01-150	200	6/48	5907558406054



Szczypce do pierścieni osadzczych

Circlip pliers / Zange für Stellringe / Щипцы для стопорных колец / Щипцы для стопорних кілець / Zégergyűrű fogó / set clește cu spirală / Klešče pro stavěcí kroužky / Segerky vonkajšie rovné / Klešče seger / Replės žiedams / Sprostgredzenu stangas / Vedrunāpīsad / Клещи Зегер / Kružna Klijesta / Kruzna klesta / Ασφαλιστημίδες / Alicates para anillos de asiento / Pinza per anelli elastici / Pinças p. Anéis / Pince pour bagues de retenue / Tang voor dopringen

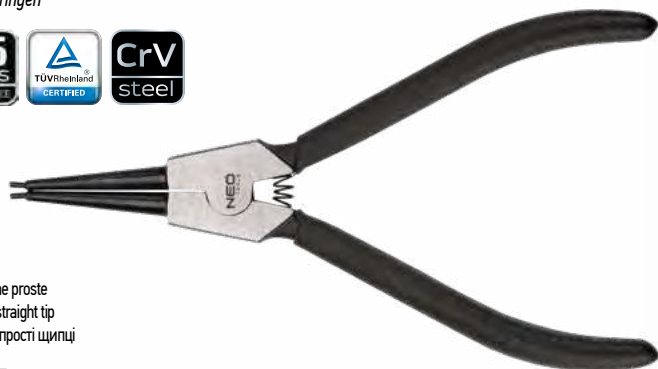

zewnetrzne proste
external, straight tip
зовнішні/прости щипці



Ref.	L[mm]	Ra[mm]	☒	EAN
01-085	150	10-25	6/48	5907558440584
01-087	180	19-60	6/48	5907558440607
01-089	230	40-100	6/36	5907558440621



wewnetrzne proste
internal, straight tip
внутрішні/прости щипці



Ref.	L[mm]	Ra[mm]	☒	EAN
01-086	150	10-25	6/48	5907558440591
01-088	180	19-60	6/48	5907558440614
01-090	230	40-100	6/36	5907558440638



zewnetrzne wygięte
external, bent tip
зовнішні/вигнуті щипці



Ref.	L[mm]	Ra[mm]	☒	EAN
01-091	145	10-25	6/48	5907558440645
01-093	170	19-60	6/48	5907558440669
01-095	220	40-100	6/36	5907558440683



wewnetrzne wygięte
internal, bent tip
внутрішні/вигнуті щипці



Ref.	L[mm]	Ra[mm]	☒	EAN
01-092	145	10-25	6/48	5907558440652
01-094	170	19-60	6/48	5907558440676
01-096	220	40-100	6/36	5907558440690

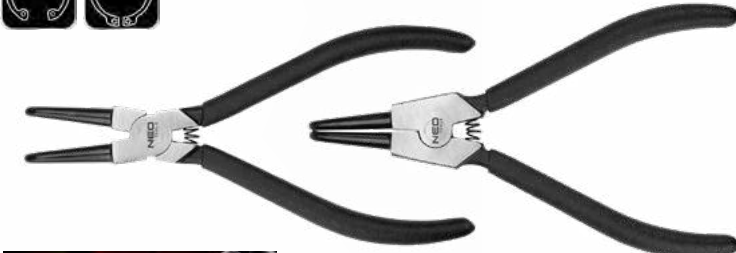

Ref.	L[mm]	Ra[mm]	☒	EAN
01-097	170/180	19-60	4/16	5907558463606

Szczypce zaciskowe

Locking pliers / Klemmzange / Клещи зажимные / Пласкозубці обтискні / Patentfogó / clește fixator / Upinací klešče / Klešče fixačné univerzálne / Prijemne klešče / Užspaidimo replės / Fiksatorstangas / Lukustustangid / Клещи Чупак / Stop klijesta / Smrt klesta / Πένιας - Γκρίν / Tenazas grip / Pinza a scatto dritta / Pinças para grampear / Pince de serrage / Krimptang



Ref.	L[mm]	Ra[mm]	☒	EAN
01-216	250	0-47	6/36	5907558409185



Ref.	L[mm]	Ra[mm]	☒	EAN
01-217	250	0-45	6/36	5907558409192



Szczypce blacharskie

Axial grip locking pliers / Klemmzange / Клещи зажимные / Плоскозубицi обтискини / Patentfogó / Clește fixator / Uprinací kleště / Kliešte fixačné univerzálne / Prijemne klešče / Užspaudimo replės / Fiksatorstangas / Lukustustangid / Клещи чирак / Stop klijesta / Smrt klesta / Певэс – үкpin / Tenazas grip / Pinza griffante / Pinças para grampear / Pince de serrage / Krimptang



TYPE
W
195
mm

Ref.	info	☒	EAN
11-020	W, max. 25 mm	1/20	5907558445473



TYPE
L
195
mm

Ref.	info	☒	EAN
11-021	L, max. 57 mm	1/20	5907558445480



TYPE
LL
205
mm

Ref.	info	☒	EAN
11-022	LL, max. 18 mm	1/20	5907558445497



TYPE
JJ
230
mm

Ref.	info	☒	EAN
11-024	JJ, max. 40 mm	1/20	5907558445510

Szczypce uniwersalne 1000V

Combination pliers / Kombizange / Пассатижи / Пасатижи / Kombinált fogó / clește universal / Kombinované kleště / Kliešte kombinované / Kombinirane klešče / Universalios replės / Plakanknaibles kombinētās / Universaalnāpitsad / Клещи комбинируни / Kombinirana klijesta / Πένσα γενικής χρήσης / Alicates universales / Pinza universale 1000V / Pinças universais / Pince universelle / Universele tang

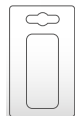

Ref.	L[mm]	☒	EAN
01-220	160	6/60	5907558433043
01-221	180	6/60	5907558433050
01-222	200	6/60	5907558433067



Ref.	L[mm]	☒	EAN
01-240	160	6/48	5907558433364
01-241	180	6/48	5907558433371

Szczypce wydłużone proste 1000V

Long nose pliers / Gerade Zange, verlängert / Плоскозубицi удлинённые прямые / Плоскозубицi з видовженими зубцями / Hosszúcsőrű fogó / Clește ascuțit bine / Kleště prodloužené rovné / Kliešte špicaté rovné / Koničaste klešče / Replės pailgintos, tiesios / Plakanknaibles pagarinātās taisnās / Pikkmokk-nāpitsad / Клещи Човки / Flah Klijesta / Flah klesta / Μυροτσιμίδο μα μακρά ράμφη / Alicates largos rectos / Pinza a becco lungo 1000V / Pinças retas prolongadas / Pince allongée droite / Lange rechte tang



Ref.	L[mm]	☒	EAN
01-223	160	6/60	5907558433074
01-224	180	6/60	5907558433081
01-225	200	6/60	5907558433098

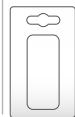

Ref.	L[mm]	☒	EAN
01-242	160	6/48	5907558433388



Szczypce wydłużone wygięte 1000V

Long nose bent pliers / Zange lang, gebogen / Плоскогубцы удлиненные изогнутые / Щипци видовжені, вигнуті / Hajlított csőrű fogó / Cleste varf ascuțit indoit / Kleště prodloužené vyhnuté / Kliešte predĺžené vyhnuté / Koničaste klešče - upognjene / Prailgintos replės, lenktos / Izliektas pagarinātas knaibles / Pikkade kõverate otstega näpitsad / Клещи удължени огънати / Izdužena savinuta klješta / Izdužena uvijena klešta / Μυτατούμπιο κούρτό / Alicate Teléfono curvo / Pinza universale 1000V / Pinças curvadas prolongadas / Pince allongée coudées / Lange gebogen tang



Ref.	L[mm]	⊠	EAN
01-227	160	6/60	5907558433111
01-228	180	6/60	5907558433128

Szczypce do rur 1000V

Water pump pliers / Rohrzange / Клещи трубные / Кліщци трубні / Vízpumpa fogó / clește p/u pompa de apă / Kleště na trubky / Hasák / Cevne klešče / Replės vamzdžiams / Rorstangas / Veepumba tangid / Клещци Гаража / Klješta papige / Klesta paragaļ / Γκαζοτάβλα / Tenazas para tubos / Pinza giratubi 1000V / Pinças p. Tubos / Pince pour tubes / Buistang



Ref.	L[mm]	⊠	EAN
01-232	250	6/36	5907558433166

Szczypce boczne 1000V

Diagonal cutting pliers / Seitenzange / Бокорезы / Бокозізци / Oldalsípő fogó / clește ascuțit diagonal de tăiat sîrmă / Boční kleště / Cvikačky bočné / Stranske klešče / Šoninės replės / Sänknaibles / Diagonaal-löiketangid / Клещци Рєзачки / Klješta cvikerice / Klesta poluokrugla / Πλακοκόφτες / Alicates diagonales / Tronchese laterale 1000V / Pinças laterais / Pince latérale / Zijtang



Ref.	L[mm]	∅ [mm]	⊠	EAN
01-525	160	1.5; 2.5	0/36	5907558404340



Ref.	L[mm]	⊠	EAN
01-226	160	6/60	5907558433104



Ref.	L[mm]	⊠	EAN
01-243	160	6/48	5907558433395



Ref.	L[mm]	⊠	EAN
01-231	180	6/60	5907558433159



Szczypce do cięcia kabli 1000V

Cable cutter / Kabelabschneider / Кабелерез / Обрізувач для кабелю / Kábelvágó fogó / Cleste pentru taiat cabluri / Kleště na kabely / Kliešte na káble / Nož za rezanje kablov / Kandiklės kabeliui / Kabelu griezējs / Kaabliõikur / Резачка за кабелу / Rezač kablova / Nož za rezanje kablova / Κόφτης καλωδίων / Alicate cortacables / Taglia cavo 1000V / Cortador p. Cabos / Coupe-câbles / Knipper voor kabels



Ref.	L[mm]	⊠	EAN
01-244	180	6/48	5907558433401



Ref.	L[mm]	⊠	EAN
01-233	160	6/60	5907558433173



Szczypce do izolacji 1000V

Wire stripper / Isolierungszange / Бокорезы для зачистки / Бокорізи для зачищування / Kábelcsupaszoló / clește p/u înlăturarea izolatorului / Klešče na izolaci / Klešče za odizolovacie / Klešče za snemanje izolacije / Replės izoliacijai nuimti / Knaibles izoliacijai / Каблiтiнгид / Клепци Заголвачки за монтаж / Klesta za izolaciju / Απογυμνωτές καλωδίων / Alicates pelacables / Pinza spela fili regolabile 1000V / Pinças p. Isolação / Pince à dénuder / Isolatieltang



Ref.	L[mm]	Ø [mm²]	⊠	EAN
01-245	160	0.2 - 6.0	6/48	5907558433418

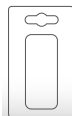

Ref.	L[mm]	Ø [mm²]	⊠	EAN
01-229	160	0.2 - 6.0	6/60	5907558433135

Nóż monterski 1000V

Fitter's knife / Monteurmesser / Нож монтерский / Ніж монтерський / Kábelvágó kés / Cutit pentru cabluri / Nůž montérský / Montérsky nôž / Montažni nôž / Montuotojo peilis / Montiera nazis / Elektrikunuga / Монтерський нож / Monterski nôž / Monterski nôž / Μαχαίρι ηλεκτρολόγου / Cuchillo recto para cables / Coltello per elettricisti / Faca p. montagem / Couteau de monteur / Montagemes

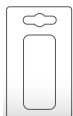
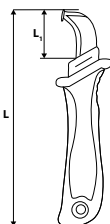

Ref.	L[mm]	L ₁ [mm]	⊠	EAN
01-550	195	50	12/72	5907558409239

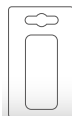
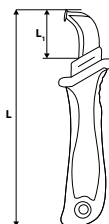

Ref.	L[mm]	L ₁ [mm]	⊠	EAN
01-551	190	50	12/72	5907558409246

Zestaw narzędzi 1000V

Tools set / Werkzeugsatz / Набор инструментов / Набор інструментів / Szerszámkészlet / Set scule de grădini / Sada náradí / Súprava náradia / Garnitura orodja / Įrankių komplektas / Instrumentu komplekts / Тööriistakomplekt / Геодор комплeкт / Set uređaja / Set alata / Συλλογή εργαλείων / Juego de herramientas / Set attrezzi 1000V / Kit de ferramentas / Jeu d'outils / Gereedschapset

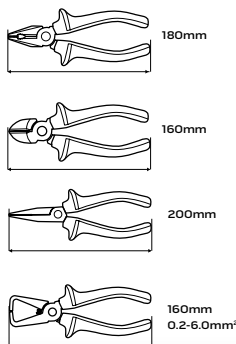

Ref.	⊠	EAN
01-236	0/8	5907558433203

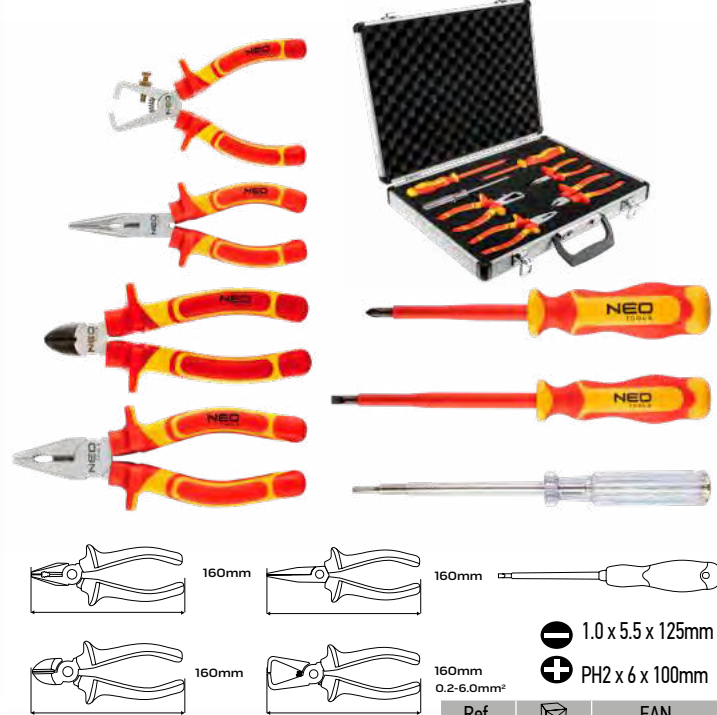

1.0 x 5.5 x 125mm
PH2 x 6 x 100mm

Ref.	⊠	EAN
01-235	0/6	5907558433197



Zestaw narzędzi 1000V

Tools set / Werkzeugsatz / Набор инструментов / Набор инструментов / Szerszámkészlet / Set scule de grădină / Sada nářadí / Súprava náradia / Garnitura orodja / Įrankių komplektas / Instrumentu komplekts / Tööriistakomplekt / Тодоре комплект / Set uređaja / Set alata / Συλλογή εργαλείων / Juego de herramientas / Set attrezzi 1000V / Kit de ferramentas / Jeu d'outils / Gereedschapsset

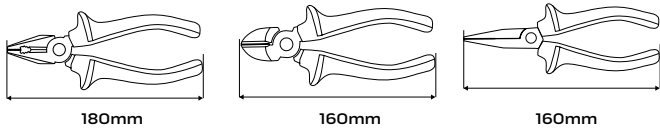

⊖ 5.5x125 mm ⊕ PH1x80

Ref.	⊞	EAN
01-237	0/8	5907558433210

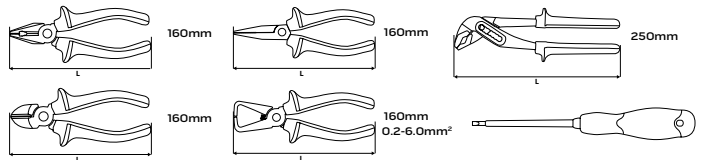

⊖ 1.0 x 5.5 x 125 mm; 0.8 x 4 x 100 mm; 1.0 x 6.5 x 150 mm
 ⊕ PH0 x 3 x 60 mm; PH2 x 6 x 100 mm;
 PH1 x 4.5 x 80 mm; PH3 x 8 x 150 mm

Ref.	⊞	EAN
01-234	0/6	5907558433180

Ściągacz izolacji

Wire stripper / Abziehvorrichtung für Isolierung / Съемник изоляции / Знімач ізоляції / Kábelcsupaszoló / Dispozitiv de scos izolatie / Stahovač izolace / Kliešte na stahovanie izolácie / Snamalnik izolacije / Izolācijas nuēmimo replēs / Izolācijas noņēmtājs / Изолираща скоба / Skidač izolacije / Skidač izolacije / Εργαλείο για αφαίρεση μόνωσης / Alicates pelacables / Spelafili universale / Ponta de aperto de izolação / Dénudeur d'isolation / Trekker voor isolatie



Ref.	L[mm]	⊞	EAN
01-524	125	15/90	5907558415643

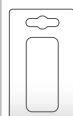

Ref.	L[mm]	⊞	EAN
01-400	170	0/40	5907558449617



Automatyczny ściągacz izolacji

Automatic wire stripper / Automat. Abziehzange / Съемник изоляции автоматический / Автоматичний стягувач ізоляції / Kábelcsupaszoló automata / Clește automatic p/u extragerea izolației / Automatické stahovadlo izolace / Kliešte odizolovacie automatické / Klešče za snemanje izolacije / Automatinis izoliacijos nuimtuvas / Stangas izolācijas noņemšanai automātiskās / Autoaatsed kaablitangid / Клеци заголювачки / Klijesta za izolaciju / Klesta za izolaciju / Αυτόματος απογυμνωτής καλωδίων / Alicates pelacables automáticos / Spelafili automatico / Aparelho automático de remover isolação / Dénudeuse d'isolation automatique / Automatisch draadstriptang



Ref.	L[mm]	⊠	EAN
01-519	195	10/60	5907558415599



Ref.	L[mm]	⊠	EAN
01-520	170	8/48	5907558415605



Ref.	L[mm]	⊠	EAN
01-538	175	8/48	5907558484571



Ref.	L[mm]	⊠	EAN
01-534	180	10/40	590755843935



Ref.	L[mm]	⊠	EAN
01-500	205	10/60	5907558403190



Ref.	L[mm]	⊠	EAN
01-540	200	10/40	5907558454994



Ref.	L[mm]	⊠	EAN
01-542	205	0/10	5907558485493



Szczypce do zaciskania końcówek

Crimping pliers / Feinzunge, zur Verklemmung der Endungen / Клещи для обжима кабельных наконечников / Щипці кабельні, затиски / Kábeláru fagó / Cleste pentru sertizat/conectori / Kleště na svíráni koncovek / Kliešte na koncovky / Klešče za stiskanje konic / Replés, antgaliú užspaudimui / Knaibles kabelu užgaļu saspišana / Otsakinnitusnäpitsad / Клещи за притискане на краища на кабелу / Kliešta za pritiskanje nastavaka / Klešta za pričvršćivanje krajeva / Πένσα ακροδεκτών / Pinzas de presión para puntas / Pinza per terminali / Pinças p. Grampear pontas / Pince universelle de serrage d'embouts / Tang voor eindstukken



Ref.	L[mm]	Info	ⓧ	EAN
01-506	220	0,5-16 mm ² (22-6 AWG)	12/24	5907558409994



Ref.	L[mm]	ⓧ	EAN
01-536	210	0/20	5907558439298



Ref.	L[mm]	ⓧ	EAN
01-507	170	5/20	5907558414394



Ref.	L[mm]	ⓧ	EAN
01-502	250	6/36	5907558408454



Ref.	L[mm]	ⓧ	EAN
01-501	195	8/48	5907558403206



Ref.	L[mm]	ⓧ	EAN
01-539	230	10/20	5907558485479



0.25-2.5 mm²

1.5-6.0 mm²



Ref.	L[mm]	ⓧ	EAN
01-532	140	20/80	5907558432367
01-533	140	20/80	5907558432374



AWG 16-10 1.5 - 6 mm² AWG 17-10 1 - 6 mm² AWG 17-10 1 - 6 mm² AWG 10-6 6 - 16 mm² AWG 20-10 0.5 - 6 mm²

Ref.	L[mm]	ⓧ	EAN
01-537	220	0/5	5907558439304



Szczypce do zaciskania końcówek

Crimping pliers / Feinzange, zur Verklemmung der Endungen / Клепцы для обжима кабельных наконечников / Щипцы кабельны, затисні / Kábelsaru fogó / Cleste pentru sertizat/conectori / Kleště na svírání koncovek / Kliešte na koncovky / Klešče za stiskanje konic / Replés, antgaliú užspaudimui / Knaibles kabelu užgalų saspiešianai / Otsakinnitusnäpitsad / Клепцы за прутискане на краіца на кабелі / Klijesta za pritiskanje nastavaka / Klešča za pričvrščivanje krajeva / Πένσα ακροδεκτών / Pinzas de presión para puntas / Pinza per terminali / Pinças p. Grampear pontas / Pince universelle de serrage d'embouts / Tang voor eindstukken



Ref.	L[mm]	⊠	EAN
01-503	250	6/36	5907558403213



Ref.	L[mm]	⊠	EAN
01-555	270	10/20	5902062063427

Pozycjoner w zestawie
Positioner included
Позиційник включений

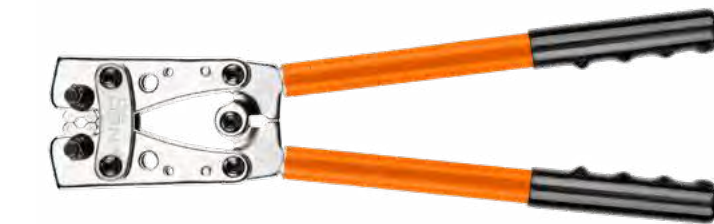

Ref.	L[mm]	⊠	EAN
01-530	390	0/10	5907558432343



Ref.	L[mm]	⊠	EAN
01-531	610	0/5	5907558432350

Praska ręczna hydrauliczna do końcówek elektrycznych

Hydraulic hand press for electric bits / Hydraulische Handpresse für Elektroböhrer / Гідравлічний ручної пресс для електросверл / Прес гідравлічний ручний для електричних долит / Hidraulikus kézi saját elektromos bitekhez / Presă hidraulică manuală pentru biți electrice / Hydraulický ruční lis pro elektrické bity / Hydraulický ruční lis pre elektrické bity / Hidraulična ročna stiskalica za električne svedre / Hidraulinis rankinis presas elektriniams grąžtams / Hidrauliskā rokas prese elektriskajiem bitiem / Χιδραυλικη ρυχνη преса за електрически бита / Υδραυλική πρέσα χειρός για ηλεκτρικά εργαλεία / Pressa manuale idraulica per punte elettriche / Prensa manual hidráulica para brocas eléctricas / Prensa manual hidráulica para brocas eléctricas / Presse hydraulique à main pour mèches électriques / Hydraulische handpers voor elektrische bits



Ref.	[mm²]	⊠	EAN
01-543	16-300	0/4	5907558485523

Nożyce do kabli i izolacji

Cable and insulation cutter / Schere für Kabel und Isolierung / Ножницы для кабеля и изолирующей оболочки / Ножницы по кабелю и изоляции / Kábelvágóólló / Foarfeca taiat/dezizolat cabluri / Nůžky na kabely a na izolaci / Nožnice na káble a izolácie / Škarje za kable in izolaciji / Žirkles kabeliui ir izolacijai / Šķēres kabelēm un izolācijai / Kaabli- ja isolatsioonikäärid / Ножницы за кабелю и изоляция / Škare za kablove i izolaciju / Μακαιρι καλωδίων και μόνωσης / Tijeras de electricista / Forbice da elettricista / Tesoura para cabos e isolação / Cisaille à câbles et isolation / Schaar voor kabels en isolatie

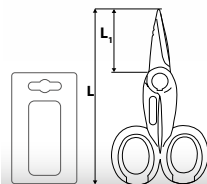

Ref.	L[mm]	L ₁ [mm]	⊠	EAN
01-511	140	45	12/72	5907558405378

Obcinak do drutów

Cable wire cutter / Abschneider für Draht / Кабелерез / Обрізувач до тросів / Drótvágó fogó / Cleste taiat cabluri / Klešče na drát / Kliešte cvikacie na káble a oceľové laná / Nož za žice in jeklenice / Kandiklės vielai ir plieniniam lynui / Stieplu vai tērauda auklu griežējs / Traadi- ja terasjuhtmelõikur / Резачка за тел истоманени въжета / Rezač za žice i čelične sajle / Nož za žicu i čeličnu užad / Κόφτης καλωδίων / Alicata para cortar cable trenzado / Troncatrice per filo / Cortador de arames / Coupe-fils / Knipper voor draad



Ref.	L[mm]	⊠	EAN
01-518	210	6/48	5907558413007



Obcinak do kabli

Cable cutter / Kabelabschneider / Кабелорез / Обрізувач для кабелю / Kábelvágó / Cleave pentru taiat cabluri / Klešče na kabely / Kliešte na káble / Nož za rezanje kablov / Kandiklės kabeliui / Kabelu griezējs / Kaablilõikur / Резачка за кабелу / Rezač kablova / Nož za rezanje kablova / Κόφτης καλωδίων / Alicate cortacables / Cesoie per cavi / Cortador p. Cabos / Coupe-câbles / Knipper voor kabels



Ref.	L[mm]	⊠	EAN
01-510	185	12/72	5907558405361

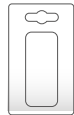

Ref.	L[mm]	max ø [mm ²]	⊠	EAN
01-516	250	325	10/30	5907558408522



Ref.	L[mm]	max ø [mm ²]	⊠	EAN
01-513	160	10	6/48	5907558408485
01-514	200	13	6/48	5907558408492
01-515	235	25	6/36	5907558408508



Ref.	L[mm]	⊠	EAN
01-401	400	5/10	5907558449624



Ref.	L[mm]	max ø [mm ²]	⊠	EAN
01-517	440	20	0/12	5907558408515

Obcinak do drutów i linek stalowych

Cable and steel wire cutter / Abschneider für Draht und Stahlseilen / Кабелорез / Обрізувач до дроту і пропіє / Drótvágó fogó / Cleave taiat cabluri / Klešče na drát a na ocelovú lanku / Kliešte cvikacie na káble a ocelové laná / Nož za žice in jeklenice / Kandiklės vielai ir plieniniam lynui / Stieplu vai tērauda auklu griezējs / Traadi-ja terasjuhtmelõikur / Резачка за метални стоманени въжета / Rezač za žice i čelične sajle / Nož za žicu i čeličnu užad / Κόφτης καλωδίων / Alicate para cortar cable trenzado / Troncatrice per cavi e fili in acciaio / Cortador p. Arames e cabos de aço / Cisaille à fils et câbles d'acier / Knipper voor draad en staalkabels



Ref.	L[mm]	⊠	EAN
01-512	190	10/60	5907558410891

Szczypce do rur

Water pump pliers / Rohrzange / Клещи трубные / Кліщі трубні / Vízpumpa fogó / clește p/u pompa de apă / Klešče na trubky / Hasák / Cevne klešče / Replēs vamzdžiāms / Rorstangas / Veepumba tangid / Клеци Гагза / Kliesta papige / Klesta papagaj / Γκαζοπανάλι / Tenazas para tubos / Pinza regolabile da idraulico / Pinças p. Tubos / Pince pour tubes / Buistang

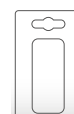
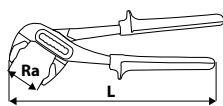

Ref.	L[mm]	Ra[mm]	⊠	EAN
01-202	250	0-36	6/48	5907558434613

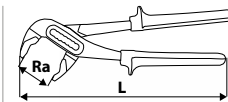

Ref.	L[mm]	Ra[mm]	⊠	EAN
01-204	250	0-42	6/48	5907558412994

Szczypce do rur

Water pump pliers / Rohrzange / Клещи трубные / Кліщи трубні / Vízpumpa fogó / clește p/у pompa de apă / Kleště na trubky / Hasák / Cevne kleště / Replės vamzdžiams / Rorstangas / Veepumba tangid / Клещы гарпа / Klijesta papige / Klesta papagai / Γκαζοτράβια / Tenazas para tubos / Pinza regulabile da idraulico / Pinças p. Tubos / Pince pour tubes / Buistang

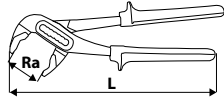

Ref.	L[mm]	Ra[mm]	☒	EAN
01-200	240	0-31	6/48	5907558434606
01-203	300	0-46	6/24	5907558434620

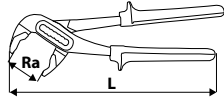

Ref.	L[mm]	Ra[mm]	☒	EAN
02-435	240	0-52	6/60	5907558464634
02-436	300	0-60	6/36	5907558464641

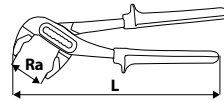

Ref.	L[mm]	Ra[mm]	☒	EAN
02-401	250	10-45	6/48	5907558462913

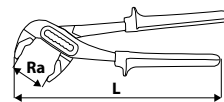

Ref.	L[mm]	Ra[mm]	☒	EAN
02-412	250	0-38	6/60	5907558463026
02-413	300	0-45	6/48	5907558463033

Klucz łańcuchowy do rur

Chain pipe wrench / Kettenschlüssel für Rohre / Ключ трубный цепной / Ключ трубный ланцюговий / Csőfogó láncos / Cheie pentru filtrul cu lant / Řetězový hasák na trubky / Ključ reťazový na rúry / Veržni ključ za cevi / Grandininis raktas, vamzdžiams / Κέδες σωρούυ atslēga / Kett-toruvöti / Верижен тръбен ключ / Lančani ključ za cijevi / Ključ za cevi lančani / Αλυσοκόβουρας σωλήνων / Llave de cadena para tubos / Giratubi a catena / Chave de corrente p. tubos / Clef à chaîne pour tubes / Kettingsseutel voor buizen



Ref.	L [mm]	Ra [mm/"]	☒	EAN
02-444	300	115/4	0/24	5907558481570

Klucz do rur stillson

Stillson pipe wrench / Rohrschlüssel stillson / Ключ трубный stillson / Ключ трубный «Stillson» / Csőfogó „Stillson” / Cheie reglabila pentru tevi / Kleště trubkové Stillson / Ključ na rúry stillson / Ključ za cevi stillson / Raktas vamzdžiams „Stillson” / Cauruļu atslēga / Stillson-toruvöti / Тръбен ключ stillson / Ključ za cijevi stillson / Ključ za cevi stillson / Σωληνοκόβουρας τύπου Stillson / Llave stillson / Giratubi Stillson / Chave p. Tubos stillson / Clef pour tubes stillson / Seutel voor stillsonbuizen

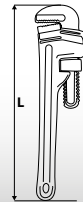

Ref.	L [mm]	Ra [mm/"]	☐ [kg]	☒	EAN
02-415	250	50/1.5	0.62	6/36	5907558463040
02-416	300	70/2.0	0.94	0/24	5907558463057
02-417	350	80/2.0	1.25	0/18	5907558463064
02-418	450	90/2.5	1.79	6/12	5907558463071
02-419	600	100/3.0	2.73	4/8	5907558463088

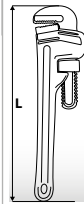

Ref.	L[mm]	Ra ["]	☒	EAN
02-106	300/12"	1 3/4"	0/24	5907558434583
02-107	350/14"	2"	0/24	5907558434590

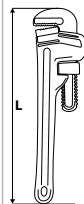

Ref.	L[mm]	Ra ["]	☒	EAN
02-111	450	1 3/4"	0/24	5907558435856
02-112	600	2"	0/24	5907558435863



Obcinak do rur

Tubing cutter / Rohrab Schneider / Труборез / Τρυβροπία / Csővágó / Dispositiv tăiere țevi / Trubkořez / Rezač rúrok / Rezalec cevi / Žirklės vamzdžiams / Caurulgriezējs / Torulöikur / Τρυβροπία / Rezač cijevi / Sekac za cevi / Κόπτης σωλήνων / Cortador de tubos / Taglia tubi / Cortador p. tubos / Coupe-tube / Buisknipper



25 years GUARANTEE

TÜV Rheinland CERTIFIED

max 2.5mm

STEEL

Ref.	Ra [mm]	Ra ["]	⊠	EAN
02-040	19-83	3/4-3.1/4	10/30	5907558410006
02-041	-	-	20/80	5907558410013



3-22 mm

1/8"-7/8"

CU

AL



02-407

Ref.	Ra ["]	Ra [mm]	⊠	EAN
02-429	1/8-7/8	3-22	50/200	5907558463514
02-407		x6	40/200	5907558462975



02-010

TÜV Rheinland CERTIFIED

25 years GUARANTEE

∅ 35 mm

56-58 HRC

AL CU



02-005

Ref.	info	⊠	EAN
02-010	35 max ∅ [mm]	6/36	5907558408461
02-005	3 x	40/200	5907558408973



CU

AL

∅ 3-32 mm

1/8"-1 1/2"



02-407

Ref.	Ra ["]	Ra [mm]	⊠	EAN
02-403	1/8-1.1/4	3-32	12/48	5907558462937
02-407		x6	40/200	5907558462975



02-042

STEEL



02-044

Ref.	info	Ra [mm]	Ra ["]	⊠	EAN
02-042	-	3-50	1/8-2.0	0/8	5907558414332
02-044	2 x	-	-	24/288	5907558415735



CU

AL

∅ 3-30 mm

1/8"-1 1/2"



02-407

Ref.	Ra ["]	Ra [mm]	⊠	EAN
02-402	1/8-1.1/4	3-32	12/72	5907558462920
02-407		x6	40/200	5907558462975



STEEL

∅ 12-50 mm

1/2"-2"



02-409

Ref.	Ra ["]	Ra [mm]	⊠	EAN
02-406	1/2 - 2	12-50	0/10	5907558462968
02-409	-	-	20/100	5907558462999



CU

AL

PLASTIC

50-127 mm

2-5"

QUICK ADJUSTING



02-442

Ref.	Ra ["]	Ra [mm]	⊠	EAN
02-430	2-5	50-127	0/10	5907558464580
02-442	-	-	0/200	5907558464689



Klucz nastawny

Adjustable wrench / Schraubenschlüssel / Ключ разводной / Ключ разводный гаечный / Csavarkulcs állítható / Cheie reglabilă / Klíč přestavitelný / Nastavitelný klíč / Francoski ključ / Reguliojamas raktas / Bīdatslēga / Tellitan vōti / Раздвижен гаечен ключ / Podesivi ključ / Francuski ključ / Γαλλικό κλειδί / Llave inglesa / Chiave a rullino / Chave regulável / Clef à ouverture réglable / Verstelbare moersleutel

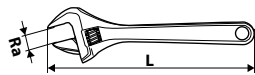

Ref.	Ra [mm]	L [mm]	⊠	EAN
03-017	0-30,5	200	0/36	5907558404326



Ref.	L [mm]	Ra [mm]	⊠	EAN
03-015	150	0-34	6/96	5907558412208
03-014	200	0-38	6/72	5907558404159
03-016	250	0-50	5/30	5907558412215



Ref.	L [mm]	Ra [mm]	⊠	EAN
03-023	155	0 - 28	6/72	5907558426052
03-024	205	0 - 32	6/72	5907558426069
03-025	256	0 - 43	6/36	5907558426076
03-026	306	0 - 53	6/36	5907558426083



Ref.	L [mm]	Ra [mm]	⊠	EAN
03-010	150	0-24	6/120	5907558404111
03-011	200	0-28.6	6/60	5907558404128
03-012	250	0-32.8	6/48	5907558404135
03-013	300	0-38	6/24	5907558404142



Ref.	L [mm]	Ra [mm]	⊠	EAN
03-027	150	0 - 23	6/120	5907558426090
03-028	200	0 - 28	6/60	5907558426106
03-029	250	0 - 32	6/48	5907558426113



Ref.	L [mm]	Ra [mm]	⊠	EAN
03-019	118	0 - 28	6/72	5907558426014
03-020	139	0 - 32	6/72	5907558426021
03-021	156	0 - 43	6/36	5907558426038
03-022	185	0 - 53	6/36	5907558426045

Nóż z ostrzem łamanym

Snap-off blade knife / Messer m. gebrochener Klinge / Нож с отламывающимся лезвием / Нож с ламаним лезом / Törhető pengés kés / Čužit lamä demontabilä / Nůž se zalomeným ostrím / Nožik lámací / Nož / Peilis su nulaužiama geležite / Tarpėšu nazis / Kokkukäiva teraga nuga / Макетен нож / Skalpel / Skalpel / Κοπίδι «snap Off» / Cúter / Tagliarino con lama scorrevole / Faca com lâmina curvada / Couteau à lame cassable / Met met gebroken lemmet



Ref.	W [mm]	⊠	EAN
63-012	25	12/72	5907558443530



Ref.	W [mm]	⊠	EAN
63-060	18	12/72	5907558420777



Ref.	W [mm]	⊠	EAN
63-050	18	12/72	5907558420760



Ref.	W [mm]	⊠	EAN
63-013	9	48/576	5907558484311



Nóż z ostrzem łamanym

Snap-off blade knife / Messer m. gebrochener Klinge / Нож с отламывающимся лезвием / Нож з ламаним лезом / Törhető pengés kés / Cutit lamä demontabilă / Nůž se zalomeným ostrím / Nožik lámací / Nož / Peilis su nulažiamia geležte / Tapešu nazis / Kokkukäiva teraga nuga / Накетен нож / Skalpel / Skalpel / Копібі «snap Off» / Cúter / Taglierino con lama scorrevole / Faca com lâmina curvada / Couteau à lame cassable / Met met gebroken lemmet



Ref.	W [mm]	⊠	EAN
63-021	18	12/48	5907558410457



Ref.	W [mm]	⊠	EAN
63-014	18	40/160	5907558484328



Ref.	W [mm]	⊠	EAN
63-011	18	12/72	5907558410440



Nóż z ostrzem trapezowym

Knife with utility blade / Messer mit Trapezklinge / Нож с трапецеидальным лезвием / Нож з трапецеидальним вістрям / Trapézpengés összecskukható kés / Cutter cu tăiş trapezoidal / Nůž s trapézovým ostrím / Nůž s trapézovou čepeľou / Nož s trapeznim rezilom / Peilis su trapezine geležte / Nazis ar trapezveida asmeni / Trapetsteraga nuga / Нож с трапецеовидно острие / Nož s trapezastom ostricom / Nož sa trapezastom ostricom / Μαχαίρι με τραπεζοειδή ακμή / Cúter con hoja trapezoidal / Taglierino a lama fissa / Faca com Lâminas de trapézio / Couteau à lame trapézoidale / Trapezium mes



Ref.	⊠	EAN
63-700	6/48	5907558483932



Ref.	W [mm]	⊠	EAN
63-702	18	0/80	5907558400212

Ostrza łamane

Snap off blades / Klingen, abbrechbar / Лезвия сменные отламывающиеся / Леза змінні, що обламуються / Törhető penge / Lame cutter / Odlamovací čepele / Odlamovacie čepele / Lomljiva rezila / Laužomi peiliukai / Maināmie nolaužāmie asmeņi / Vaibanoa terad / Отпывацци се остриета / Lomljene oštrice / Lomljene oštrice / Αποσπώμενες λεπίδες / Hojas segmentadas / Ricambio lame scorrevoli / Lâminas curvadas / Lames coupées / Gebogen bladen



Ref.	L [mm]	⊠	EAN
64-012	9	10/120	5907558443547
64-013	18	10/120	5907558443554
64-014	25	10/120	5907558443561



Ref.	W [mm]	⊠	EAN
64-020	18	10/300	5907558400236



Ostrza łamane

Snap off blades / Klíngen, abbrechbar / Лезвия сменные отламывающиеся / Леза змінні, що обламуються / Törhető penge / Lame cutter / Odlatovací čepele / Odlatovacie čepele / Lomljiva rezila / Laužorni peiliukai / Maināmie nolaužāmie asmeņi / Vaibanota terad / Отчупляюща се оструєта / Lomljene oštrice / Lomljene oštrice / Ανοσώμενες λεπίδες / Hojas segmentadas / Ricambio lame scorrevoli / Láminas curvadas / Lames coupées / Gebogen bladen



x10

TITANIUM blade



Ref.	W [mm]	⊠	EAN
64-220	9	10/300	5907558400250



x10



Ref.	W [mm]	⊠	EAN
64-010	18	10/300	5907558400229



x10



Ref.	W [mm]	⊠	EAN
64-210	9	10/300	5907558400243



Ostrza hakowe

Hook blades / Hackenklíngen / Лезвия-крючки / Леза гакови / Törhető penge / Lame secară pentru cutter / Háková čepele / Hákové čepele / Kjukasta rezila / Geležte / Asmeņi-āķi / Konksterad / Оструєта за хуку / Kukaste oštrice / Kukasti noževi / Κοιτίδι τάρητα / Hoja de gancho / Ricambio lame ad uncino / Láminas de anzol / Lames à crochets / Haakbladen

x5



Ref.	⊠	EAN
64-610	10/300	5907558400281

x5

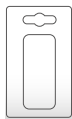

Ref.	⊠	EAN
64-620	10/300	5907558400298



Ostrza trapezowe

Knife blades / Trapezklíngen / Лезвия трапецевидные / Леза ножови / Törhető penge / Çuđit lamä / Lichoběžníkové ostří / Ostrie lichoběžníkové / Nadomestna rezila / Keičiatos geležtes / Naža asmeņi / Noaterad / Острує резервно / Nožiči za skalpel / Nožici za skalpel / Ανταλλακτικές λεπίδες / Hojas trapezoidales / Ricambio lame fisse / Láminasde trapezio / Tranchants trapézoidaux / Trapezium mesbladen

BLACK BLADE

SK2 steel

x10



Ref.	W [mm]	⊠	EAN
64-015		10/240	5907558443578

x5

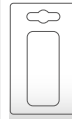

Ref.	L [mm]	⊠	EAN
64-420	52	10/300	5907558400274



x5



Ref.	L [mm]	⊠	EAN
64-410	52	10/300	5907558400267

Nóż uniwersalny

Knife / Universalmesser / Нож универсальный / Нож / Trapézpengés összecukható kés / Çuđit / Univerzální nůž / Nôž univerzálny / Nož / Universalus peilis / Nazis / Nuga / Ножиче / Džepni nožić / Noz / Μαχαίρι γενικής χρήσης / Cuchillo universal / Taglierino a lama fissa / Faca universal / Couteau universel / Universele mes

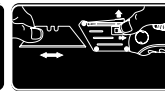

SAFETY LOCK

x5

METAL BODY



Ref.	⊠	EAN
63-710	6/48	5907558420791

Nożyczki

Scissors / Schere / Ножницы / Ножниц / Olló / Foarfeca / Nůžky / Nožnice / Škarje / Žirklés / Šķēres / Kääril / Ножуци / Škarice / Μακασε / Tijeras / forbice da elettricista / Tesoura / Ciseaux / Schar

230 mm

6in1

DOUBLE COMPONENT HANDLE

NUTCRACKER

BOTTLE OPENER

BOX OPENER

SCRAPER

PEELER

SCISSORS



Ref.	L [mm]	⊠	EAN
64-001	230	12/72	5907558485462





NARZĘDZIA SPECJALISTYCZNE

specialized tools спеціалізовані інструменти

Zestaw kluczy nasadowych do filtra oleju

Cap type oil filter wrench set / Steckschlüsselsatz für Ölfilter / Набор торцовых ключей к масляному фильтру / Набор накидных ключів до оливного фільтру / Dugókulcs-készlet olajsűrűhöz / Set de chei tubulare pentru filtru de ulei / Sada miskovitých klíčů na olejový filtr / Súprava nástavcových kľúčov na olejový filter / Set nasadnih kľučev za oljni filter / Galvučij rinkiņys tepalo filtrui / Eļļas filtra mucīņatlēgu komplekts / Ölifiltri padrunvõtmete komplekt / Комплект гаечни ключоие за масления филтър / Garnitura nasadnih kľučeva za filter ulja / Garnitura kľučeva patikača za filtere za ulje / Σετ μπουλονόκλειδα για φίλτρο λαδιού / Juego de llaves de vaso para filtro de aceite / Completo di chiavi a bussola per il filtro dell'olio / Jojo de chaves tubulares para filtro de óleo / Jeu de clés à douille pour filtre à huile / Set van dopseutels voor oliefilter

x30

x16



Ø	Ø mm	N	
	66	6	Fiat Punto 1.2; Renault Clio 1.2, Rapid, Twingo
	65	14	Daihatsu; Toyota; Nissan; Fiat; Camry
	65-67	14	Daihatsu; Toyota; Mazda; Mitsubishi
	68	14	Mazda; Ford; Subaru; Toyota
	73	14	Toyota; Lexus
	74	15	Audi; Rover; Chrysler; Lexus; GM
	74-76	15	Ford; Opel; VW; Audi; Mercedes; GM
	75-77	15	VW; Audi; Isuzu; Mercedes; GM; Chrysler
	76	12	Fiat; Mercedes; Renault
	76	14	VW; Porsche; Mercedes; BMW; Audi; Opel; Buick
	76	30	Ford; VW; Renault; Peugeot
	76	8	Fiat; Lancia
	78	15	Nissan; Ford; Toyota
	80	15	Nissan; Honda; Opel; Mazda; Iveco

Ø	Ø mm	N	
	80	15	Subaru; Toyota; Honda; Nissan; Iveco; Hyundai; Mazda
	86	16	Volvo
	86	18	VW Golf; Audi A6 TDI; Peugeot; Citroen
	90	15	Honda; Mitsubishi; Isuzu; Mazda
	92	10	Fiat
	93	15	Mazda; Volvo; Mitsubishi; Nissan; Honda
	93	36	Ford; Audi
	93	45	VW; Audi TDI
	95	15	Toyota; Alfa Romeo; Ford
	96	18	Audi A4; A6 TDI; VW Passat TDI; Renault Laguna
	100	15	Isuzu; Mitsubishi; Buick; Hyundai; Iveco; Daewoo; Renault
	106	15	Fiat Ducato
	108	15	Volvo
	108	18	Renault Espace; Laguna; Safrane; Traffic

Ref.	Ra[mm]	⊠	EAN
11-242	66-108	1/2	5907558435955

Ref.	Ra[mm]	⊠	EAN
11-243	65-100	1/10	5907558435962

Nasadka do filtra oleju

Cap type oil filter wrench / Ölfilterkappen / Съемник масляного фильтра "чашка" / Знімач масляного фільтру "чашка" / Csésze olajsűrű lehozó / Cupă filtru de ulei / Stahovák olejového filtru / Kľúč na olejový filter / Kľuč za oljni filter / Raktas tepalo filtrui / Atslēga eļļas filtram / Ölifiltri vöti / Водещца чашка за дряза / Kľuč za uljni filter / Kľuč za uljani filter / Κλειδί φίλτρου λαδιού / Llave para filtro de aceite / Chiave per il filtro dell'olio / Chave p. filtros de óleo / Clef à filtre d'huile / Sleutel voor oliefilter



3/8"

Ref.	Ø mm	N	⊠	EAN
11-360	76	12	10/60	5907558445299
11-361	65	14	10/60	5907558445305
11-362	67	14	10/60	5907558445312
11-363	73	14	10/60	5907558445329
11-364	76	14	10/60	5907558445336
11-365	74	15	10/60	5907558445343
11-366	78	15	10/60	5907558445350
11-367	80	15	10/60	5907558445367
11-368	90	15	10/60	5907558445374
11-369	95	15	10/60	5907558445381
11-370	108	15	10/60	5907558445398
11-371	86	16	10/60	5907558445404
11-372	86	18	10/60	5907558445411
11-373	96	18	10/60	5907558445428

Klucz do filtra oleju

Oil filter wrench / Schlüssel für Ölfilter / Съемник масляных фильтров / Ключ для оливных фільтрів / Olajsűrű leszedő / Cheie pentru filtre de ulei / Kľúč na olejový filtr / Kľúč na olejový filter / Kľuč za oljni filter / Raktas tepalo filtrui / Eļļas filtru atslēga / Ölifiltri vöti / Ключ за маслен филтър / Kľuč za filter za ulje / Kľuč za uljni filter / Κλειδί αφαίρεσης φίλτρου λαδιού / Llave para filtros de aceite / Chiave per filto olio / Chave para filtros de óleo / Cle filtre a huile / Filtersleutel



Ref.	Ra[mm]	⊠	EAN
11-237	43-102	1/40	5907558437355

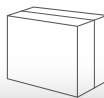

Ref.	Ra[mm]	⊠	EAN
11-239	64-100	1/40	5907558435924

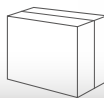

Klucz do filtra oleju

Oil filter wrench / Schlüssel für Ölfilter / Съёмник масляных фильтров / Ключ для масляных фильтров / Olajszűrő leszedő / Cheie pentru filtre de ulei / Ključ na olejovj filter / Ključ na olejovj filter / Kľuč za oljni filter / Raktas tepalo filtrui / Eļļas filtru atslēga / Öljifiltrivõtli / Ключ за маслен филтър / Kľuč za filtre za ulje / Kľuč za filter za ulje / Κλειδί αφαίρεσης φίλτρου λαδιού / Llaves para filtros de aceite / Chiave per filtro olio / Chave para filtros de óleo / Cle filtre a huile / Filtersleutel



Ref.	Ra[mm]	⊠	EAN
11-238	64-120	1/40	5907558437362



Ref.	Ra[mm]	⊠	EAN
11-231	73 - 85	6/36	5907558416657



Ref.	Ra[mm]	⊠	EAN
11-381	60 - 115	5/20	5907558445459

60-115 mm



1/2"



Ref.	Ra[mm]	⊠	EAN
11-380	80 - 115	1/20	5907558445442

80-115 mm



Klucze do spustu oleju

Oil drainer set / Ölablassschlüssel / Ключи для слива масла / Ключи для зливання оливи / Olajleeresztő kulcs készlet / Chei pentru dop de scurgerea uleiului / Klíče na vyrušnění oleje / Sada klíčův na vypuštění oleja / Vijaki za spuščanje olja / Raktai alyvos išleidimui / Eļļas nolaišanas atslēgas / Ölkorgi vőtmed / Ключове за източване на масло / Kľučevni za ispuštanje ulja / Kľučevni za ispuštanje ulja / Σετ αποστράγγισης λαδιού / Llaves para evacuación de aceite / Inserti per tappo olio / Chaves para evacação de óleo / Clés pour la vidange d'huile / Sleutels voor oliedrainage



Ref.	Ra[mm]	⊠	EAN
11-382	60 - 160	6/24	5907558445466

60-160 mm



CrV steel

3/8"

x18



20°

Ref.	Ra[mm]	⊠	EAN
11-240	63.5 - 116	6/36	5907558435931

30°
60°
90°



Ref.	Ra[mm]	⊠	EAN
11-241	63.5 - 116	5/30	5907558435931

Zastosowanie / Application / Применение:

Hex 8 mm: BMW, Ford, GM
Hex 9 mm: GM
Hex 10 mm: Ford
Hex 12 mm: Fiat, Lancia, Peugeot
Hex 14 mm: Lancia, Mercedes
Hex 17 mm: Audi, VW, BMW, Austin
Square 7, 8 mm Citroen, Peugeot, Renault, Talbot, Volvo
Square 11 mm: Ford
Square 13.1 mm: Nissan, Subaru
Square 3/8": Honda, Mazda, Renault, Saab, Volvo
Square (5/16"), 10 mm Female, Square: 10 mm: do skrzyń biegów i mechanizmów dyferencyjnych różnych marek aut np. / for gearboxes and differential mechanisms of various makes / для коробки передач и дифференциала автомобилей разных марок: BMW, Ford, Renault, Toyota
Triangular: 10 mm Renault
M16 Spline (Tamp-proof): Audi A4 i A6



Ref.	⊠	EAN
11-235	0/10	5907558417098





Коңсώwка wкpётакowa до kоркώw олежу

Special bit for oil drain plug / Spezial Bit für Ölablassschraube / Бита специальная для сливной пробки / масляного под / Бита для сливной пробки / Bit az olajdugókhöz / Bit special pentru dopul de scurgere a uleiului / Speciální bit pro vypouštění zátky oleje / Špeciálny bit pre vypúšťaciu zátku oleja / Poseben bit za zamašek za izpust olja / Specialus antgalis alyvos išleidimo kamščiai / Ipašs bit eļļas iztukšošanas aizbāznei / Spetsiaalne ots õli väljalaskekruvi jaoks / Ключ за маслени тапи / Ключ за черпове за уље / Кλειδί για βύαματα λαδιού / Llave especial tapón de aceite / Chiave speciale per tappi olio / Chave especial para óleo / Clé à bouchon d'huile spéciale / Speciale olieplugsleutel



1/4"

 Audi / SEAT / Škoda / VW:
model year 2013 with 1.2 · 1.4 · 1.8 · 2.0 l TFSI petrol engines
Audi: A1, A3, A4, A5, Q5
VW: Golf 7
SEAT: Leon, etc. with 1.6 and 2.0 l diesel engines

Ref.		EAN
11-383	20/100	5907558452266

Zestaw do misek oleju

Oil change tool kit / Ölwechsel-Werkzeugsatz / Набор инструментов для замены масла / Набор інструментів для заміни масла / Különleges szerszámkészlet olajcseréhez / Trusť de scule specială pentru schimbul de ulei / Speciální sada nářadí pro výměnu oleje / Speciálna sada náradia na výmenu oleja / Orodje komplet posebnih za menjavo olja / Įrankių rinkinys specialus alyvos keitimui / Ipašs instrumentu komplekts eļļas maiņai / Τοορίστακιολεοειστικώω spetsiaalne õlivahetuseks / Комплект инструменту за смяна на масло / Komplet alata poseban za zamjenu ulja / Комплект алата спеціални за замену уља / Είδικώω κит εργαλείων για αλλαγή λαδιού / Kit de herramientas especial para cambio de aceite / Kit attrezzi speciali per cambio olio / Kit de ferramentas especial para troca de óleo / Kit d'outils spécial pour le changement d'huile





5 ELEMENTS

1/4"

3/8"

 Audi / SEAT / Škoda / VW:
model year 2013 with 1.2 · 1.4 · 1.8 · 2.0 l TFSI petrol engines
Audi: A1, A3, A4, A5, Q5
VW: Golf 7
SEAT: Leon, etc. with 1.6 and 2.0 l diesel engines

 OEM: Connect 31775 Peugeot/Citroen (OEM 9801444780 Plug) and Ford (OEM 18711598 plug) Connect 31776 Ford (OEM 1830727 plug) Connect 31774 BMW (OEM 11137605018 plug) Connect 31771 VAG (OEM 06L 103 801 sump and cam cover plug)

Ref.		EAN
11-384	5/20	5907558452273

Odciaęarka do oleju

Oil suction gun / Ölabszieher / Отсосное устройство для масла / Олиwоwдсмкнтувач / Olajleszívó / Trägätör de ulei / Odsávačka oleje (ruční) / Odsávačka na olej / Črpalka za olje / Alyvos siurblys / Eļļas atvilcējs / Ūlisūstal / Засмукwащa маслена помпа / Sisáljka za ulje / Pumptra za ispruňavanje ulja / Αναρροητήρας λαδιού / Dispositivo de extracción de aceite / Pistola di aspirazione olio / Máquina de remover óleo / Vidangeur d'huile / Olieafzuiger



METAL

280 mm

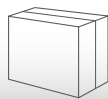

Ref.	[ml]	Ø [mm]	L [mm]		EAN
11-510	500	56,4	280	0/20	5907558415346
11-511	1000	62,5	400	0/10	5907558415353

Wanna do oleju

Oil drain bucket / Ölwanne / Ванночка для масла / Ванна оливна / Olajkád / Baie de ulei / Vana na olej / Vaňa na olej / Posoda za olje / Vanele teralui / Vannipa eļļai / Ölivan / Vana za maslo / Posuda za ulje / Kada za ulje / Λεκάνη αποστράγγισης λαδιού / Bandeja para aceite / Contenitore olio / Bandeja para troca de óleo / Bac à huile



7L

PLASTIC

Ref.		EAN
11-550	0/10	5907558415360

Miska do zlewania oleju, płynu chłódniczego

Bowl for pouring oil, coolant / Schüssel zum Umfüllen von Öl und Kühlmittel / Чаша для слива масла, охладжwающей жидкости / Чаша для зливання масла, охолоджwаючої рідини / Tál olaj, hűtőfolyadék dekantálásához / Bol pentru decantarea uleiului, lichidului de răcire / Nádoba na stáčení oleje, chladicí kapaliny / Miska na dekantáciu oleja, chladiacej kvapaliny / Miska na dekantáciu oleja, chladiacej kvapaliny / Dubuo alyvai, aušinimo skysčiai nupilti / Βλoda eļļas, dzesēšanas šķidruma dekantēšanai / Kausis õli, jahutusvedeliku dekanteerimiseks / Купа за деkantиране на масло, охладжwаща течност / Посуда за pretakanje ulja, rashladne tekućine / Посуда за преливане уља, rashladne течности / Μπολ για μετάγγιση λαδιού, ψικτωώω / Recipiente para decantar aceite, refrigerante / Ciotola per travaso olio, refrigerante / Recipiente para decantar óleo, líquido de arrefecimento / Bol pour décanter l'huile, le liquide de refroidissement / Korn voor het decanteren van olie, koelvloeistof



PE

17L

Ref.		EAN
10-800	1/6	5907558495799

Miska do zlewania oleju

Oil drain pan / Öl auffangwanne / Поддон для слива масла / Піддон для зливу масла / Olajleeresztó edény / Tava de scurgere a uleiului / Vypouštěcí nádoba na olej / Nádoba na vypúšťanie oleja / Posoda za izpust olja / Alyvos nutekėjimo indas / Eļļas noteķas panna / Ūli tūhņenduspann / Съд за източване на масло / Posuda za ispruňanje ulja / Посуда за испуштање уља / Ταψί αποστράγγισης λαδιού / Ταψί αποστράγγισης λαδιού / Vaschetta di scarico dell'olio / Bandeja de drenagem de óleo / Bac de vidange d'huile / Olie orvangbak



PE

10L

Ref.		EAN
10-801	1/4	5907558495805



Nalewak warsztatowy, konewka

Workshop pouter, watering can / Werkstattausgießer, Gießkanne / Наливная мастерская, лейка / Майстерня наливна, літка / Műhelyöntő, öntözőkanna / Atelier de turnare, adaratoare / Dilenský nálevač, konev / Dieleňský nalievač, kanva / Delavniški točilnik, zalivalka / Dirbtuvių piltuvai, laistytuvai / Darbības leiņš, lejkanna / Töökoja valaja, kastekann / Работилница за наливане, лейка / Radionička sipalica, kanta za zaljevanje / Радионички сипач, канта за заливање / Χητής ουνεργείου, ποτιστήρι / Vertedor de taller, regadera / Versatore da officina, annaffiatoio / Despejador de oficina, regador / Verseur d'atelier, arrosoir / Werkplaatsschenker, gieter



PE

Ref.	V [l]	☒	EAN
10-802	1	1/24	5907558495812
10-803	3	1/20	5907558495829
10-804	5	1/16	5907558495836

Strzykawka do płynów eksploatacyjnych

Syringe for operating fluids / Spritze für Betriebsflüssigkeiten / Шприц для рабочих жидкостей / Шприц для операційних рідин / Fecskendő működési folyadékokhoz / Seringă pentru fluide de operare / Siřkačka na provozní kapaliny / Striekačka na prevádzkové kvapaliny / Brizga za operativne tekočine / Švirkštas darbiniamis skysčiams / Šīrce darbības šķidrumiem / Süstäl töövedelike jaoks / Спринцовка за работни течности / Šprica za radne tekučine / Шприц за оперативне течности / Σύριγγα για υγρά λειτουργίας / Jeringa para fluidos operativos / Siringa per fluidi operativi / Seringa para fluidos operacionais / Seringue pour fluides opératoires / Smit voor bedrijfsvoelstoffen



PP + PVC

20cm + 21,5cm

Ref.	V [ml]	☒	EAN
10-805	200	1/25	5907558495843
10-806	500	1/20	5907558495850
10-807	1500	1/10	5907558495867

Kanister na benzynę

Can for petrol / Benzinbehälter / Канистра для бензина / Канистра для бензину / Üzemanyagkanna, mőanyag / Bidon de benzina / Kanistr na benzin / Kanistra na benzin / Kanister za bencin / Bakas benzinui / Benzina kann / Bensinikanister / Бидон за бензин / Kanister za benzin / Kántiro βενζίνης / Bidón para gasolina / Tanica per la benzina / Tanque para gasolina / Jerricane à essence / Jerrycan voor benzin



HDPE
PP
LDPE

Ref.	V [l]	☒	EAN
11-560	10	0/50	5907558436402
11-561	20	0/30	5907558436419

Lejek

Funnel / Trichter / Воронка / Voronka / Tölcsér, flexibilis, szűrővel / Pálnie / Nálevka / Lievik / Lijak / Piltuvēlis / Piltuve / Lehter / Фунія / Lijevak / Levak / Χωνί / Embudo / Imbuto / Funil / Entonnoir / Trechter

1,2 L
HDPE
LDPE



Ref.	Ø ₁ [mm]	Ø ₂ [mm]	☒	EAN
11-555	45	160	0/6	5907558436396

Smarownica dźwigniowa

Lever-operated grease gun / Schmier spritze mit Hebel / Шприц, рычажно-плунжерный / Шприц важільно-плунжерний / Karos zsírzó / Gresor cu prghie / Páková maznice / Páková mazica / Ročna mazalka / Rankinis tepalo presas / Leelõtlõts ar sviru / Kangiga määrimisese / Ръчна масльонка / Mazalica ručna / Mazalica na pumpu / Γρασαδόρος με μοχλό / Engrasadora de palanca / Pistola per grasso / Pistola de lubrificação / Graisseur à levier

400 cm³
10000 Psi
8x300 mm

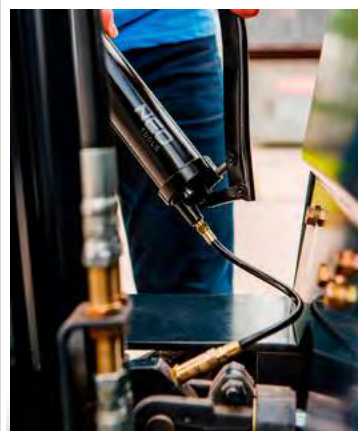

Ref.	☒	EAN
11-500	0/10	5907558415278

Wężyk do smarownic

Hose for grease gun / Schlauch für Schmiergeräte / Шланг смазочный / Шланг до дозаторів оливи / Zsírzó cső / Furtun pentru pistol de gresare/ungere / Hadička pro mazničky / Hadička do maznic / Cev za mazalnike / Žarnelè tepalinèms / Saurulite eļļas kannīnai / Ölīrpistolivoolik / Маркуч за масльонка / Crjevo za mazalice / Crevo za podmazivanje / Εύκαμπτος σωλήνας λίπανσης / Manguera para engrasadoras / Tubo in Nylon / Manguera para lubrificadores / Flexible de graisseur / Slang voor smeerapparaten



do smarownicy 11-500
for 11-500 grease gun
для нафтовиків 11-500

Ref.	L [mm]	☒	EAN
11-532	11x300	0/100	5907558415308



Separator

Spreader / Abscheider / Съемник / Сепаратор / Fémunkahenger visszanyomó tárcsafékhéz / Separator / Separátor / Separátor / Separator / Separatorijs / Separators / Separador / Сепаратор / Separator / Separator / Διαχωριστής / Separador / Separatore / Separador / Séparateur / Separator

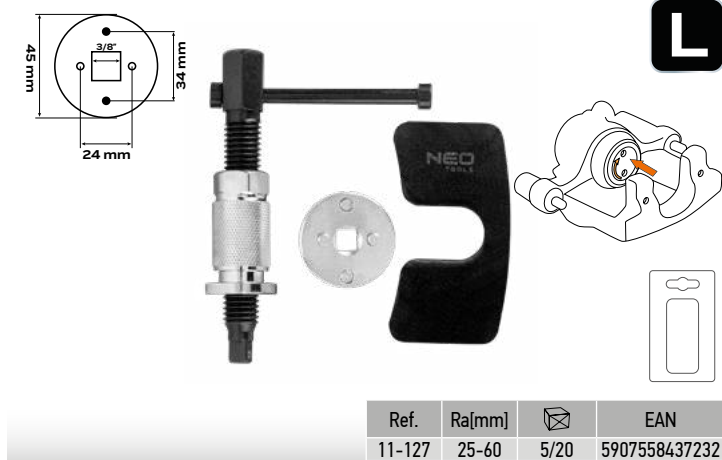
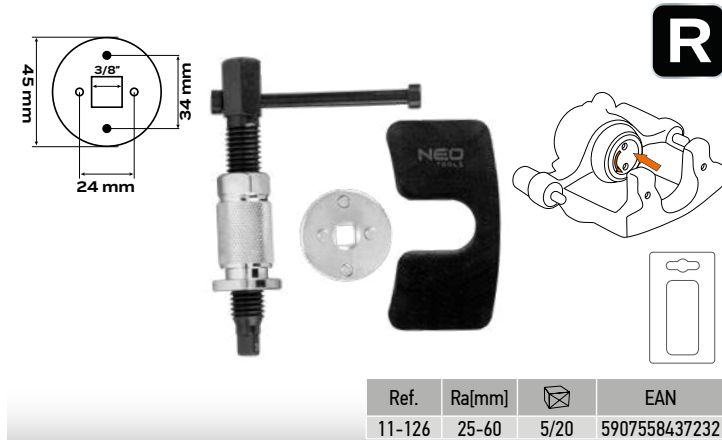
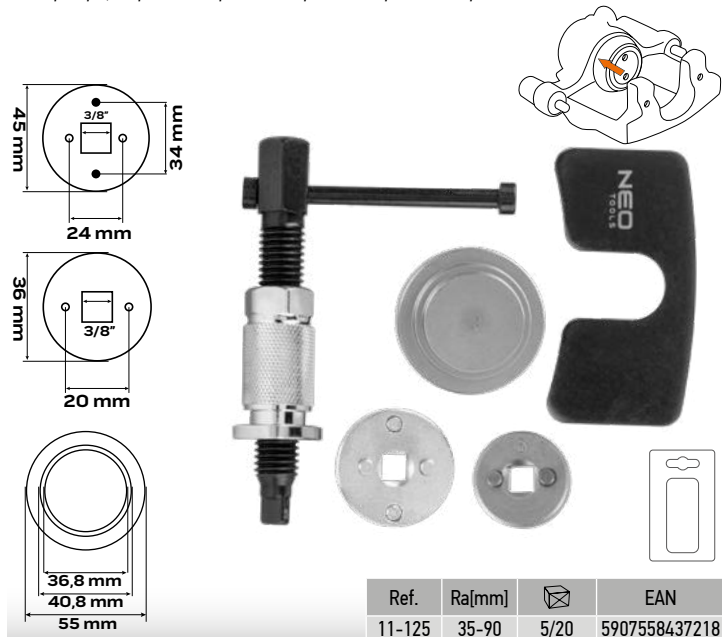

Zestaw ręcznych separatorów do zacisków hamulcowych

Set of hand separators for brake calipers / Bremskolbenrückstellersatz / Комплект приспособлений для обслуживания тормозных цилиндров / Набор ручных сепараторов для тормозных цилиндров / Tárcsafék szerelő és visszanyomó készlet / Set manual de separatori la cleme de frană / Sada na montáž kotoučových brzd / Súprava na montáž kotúčových brzd / Set ročnih ločevalnikov zavornih batov / Stabdžij cilindru suspaudimo komplektas / Bremžu cilindru manuālo separatoru komplekts / Piduriklotside sepaaratorite komplekt / Комплект ручни сепаратори за спирачните клеми / Set ručnih odvajaja za kočione stezaljke / Pribor ručnih separatora za kočione stezače / Set συντήρησης κυλινδρων πέδησης / Juego de separadores manuales para las pinzas de freno / Utensili per il riposizionamento dei pistoncini dei freni / Jogo de separadores manuais para maxilas de travão / Jeu de séparateurs manuels pour étriers de freins / Set voor handmatige afstanders voor remklemmen

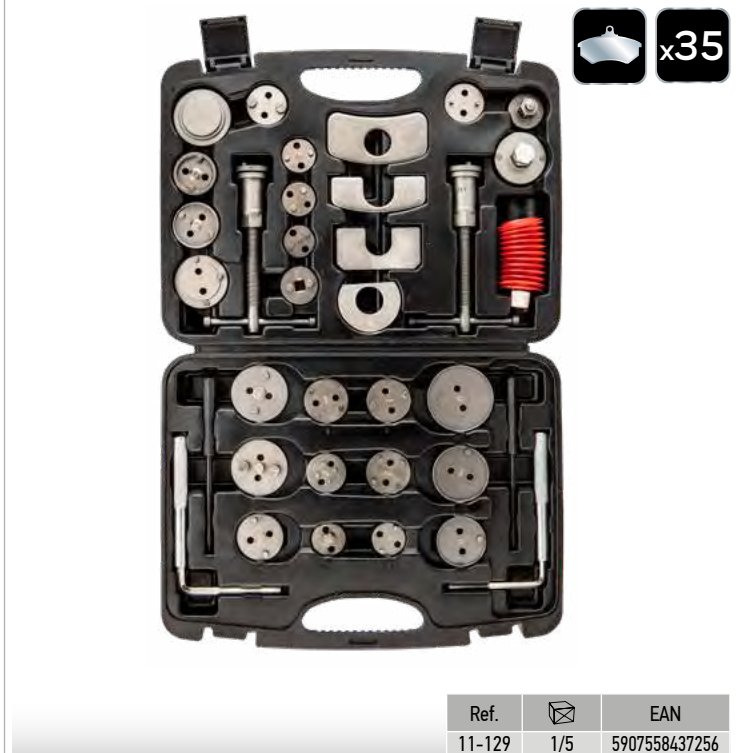

Separator pneumatyczny z końcówkami

Air brake caliper wing tool / Einstellwerkzeug für pneumatische Bremszylinder / Инструмент регулировки пневматического тормозного цилиндра / Інструмент регулювання пневматичного гальмівного цилиндра / Pneumatikus fékhenger beállító eszköz / Instrument de reglare a cilindrilor de frână pneumatic / Nástroj pro seřízení pneumatického brzdového válce / Nástroj na nastavenie pneumatického brzdového valca / Orodje za nastavitve pnevmatičnega zavornega valja / Pneumatinis stabdžių cilindro reguliavimo įrankis / Pneimatisks bremžu cilindra regulēšanas rīks / Pneuamatiline pidurisilindri reguleerimise tööriist / Пневматичен инструмент за регулиране на спирачния цилиндър / Alat za podešavanje pnevmatskog kočnog cilindra / Alat za podešavanje pnevmatskog kočnog cilindra / Εργαλείο ρύθμισης κυλίνδρου πεπιεσμένου αέρα / Herramienta de ajuste del cilindro de freno neumático / Strumento di regolazione del cilindro del freno pneumatico / Ferramenta de ajuste de cilindro de freio pneumático / Outil de réglage du cylindre de frein pneumatique / Luchtremklauw vleugel gereedschap



16
ELEMENTS

(L/R)

1/4"

Ref.	📦	EAN
11-132	0/5	5907558445435

Ściernice do czyszczenia piast

Wheel hub grinder Schleifmittel zur Reinigung von Naben / Шлифовальные круги для очистки ступицы / Шліфувальні круги для очищення маточин / Kerékagy tisztító dörzstárcsa / Discuri pentru curățarea butucilor / Brusne kotouče pro čištění nábojů / Brúsne kotúče na čistenie nábojov / Brusi za čiščenje pest / Įrankiai ratų stebulių valymui / Ritepa rumbas tiršanas slipdiski / Rataste puhastamise lihvketad / Почистювачи четки за главини / Diskovi za čiščenje glavčine / Brusione ploče za čiščenje čvorovišta / Τροχοί λείανσης για καθαρισμό πλῆμνης τροχού / Amoladora para limpiar cubos de ruedas / Dischi abrasivi per la pulizia di mozzi / Escovas circulares para limpeza de cubos de rodas / Meules pour nettoyage des moyeux / Wielnaaf grinder voor reiniging

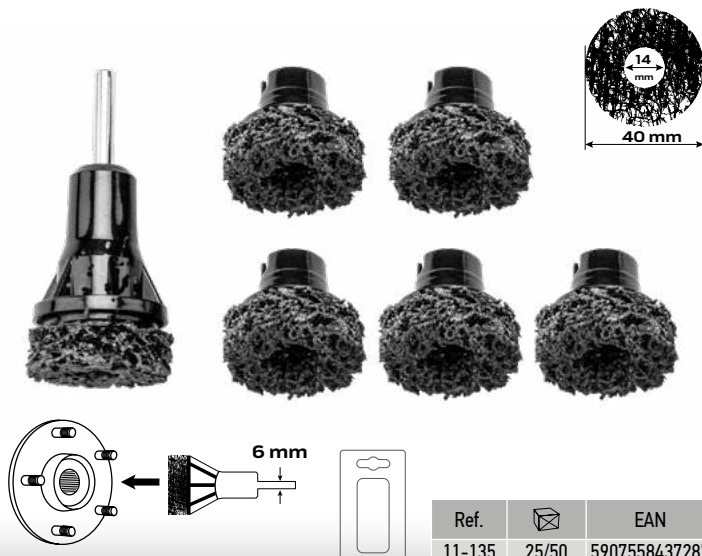

Ref.	📦	EAN
11-135	25/50	5907558437287

Zestaw do sprawdzania bicia tarcz hamulcowych

Brake disc run out kit / Prüfsatz für Unrundlauf von Brems Scheiben / Набор для проверки тормозных дисков / Набор для перевірки гальмівних дисків / Tárcsafék ütésmerő készlet / Trusă pentru verificarea bătăii discurilor de frână / Sada pro kontrolu brzdových kotoučů / Súprava na kontrolu brzdových kotúčov / Komplet za preverjanje zavornih diskov / Rinkiny stabdžių diskų patikrinimui / Bremžu disku pārbaudes instrumentu komplekts / Piduriketaste kontrollimise komplekt / Комплект за проверка на биенето на спирачните дискове / Set za provjeru kočionih pločica / Pribor za proveru kočionih diskova / Σετ ελέγχου δισκοφρένων / Kit para la comprobación de los discos de freno / Kit per il controllo dell'oscillazione assiale dei dischi freno / Kit de verificação de batimento dos discos de travão / Kit de mesure pour disques de freins / Remschijf opraken kit



±0,01
mm

Ref.	📦	EAN
11-130	1/10	5907558437263

Zestaw do montażu szczęk hamulcowych

Tool kit for brake shoe fitting / Bremsbacken-Montagewerkzeugset / Инструмент для обслуживания тормозной системы / Набор для монтажу гальмівних колодок / Fékrofaszerelő készlet / Set pentru montarea sabotilor de frana / Sada na montáž brzdových čelustí / Súprava na montáž brzdových čelustí / Set za montažo zavornih čeljusti / Stabdžių trinkelį montavimo rinkinys / Bremžu uzliku turėtąjį montażo komplekts / Pidurikingade paigaladimise komplekt / Комплект за монтиране на спирачните челюсти / Set za montažu kočionih čeljusti / Pribor za montažu kočionih čeljusti / Εργαλεία συντήρησης συστημάτων πέδησης / Kit de montaje de mordazas de frenos / Kit per montaggio pinze del freno / Jogo de ferramentas para montagem de maxilas de travão / Jeu d'outils de montage de mâchoire de frein / Set voor montage van remkaken



Ref.	📦	EAN
11-131	1/5	5907558437270



Klucz do kół

Wheel wrench / Radschlüssel / Ключ для колес / Ключ для монтажу нп автомобильних / Kereszt kerékkulcs / Cheie piuliță p/u demontarea și montarea roților / Ključ na kola / Ključ na kolesá teleskopický / Kľuč za automobilská kolesa / Raktas ratams / Riteru atslēga / Rattavöti / Ключ за гуми / Kľuč za kotač / Kľuč za točak / Κλειδί για τροχούς / Llave extensible para ruedas / Chiave a croce / Chave para filtro / Clef pour filtre / Wielsleutel

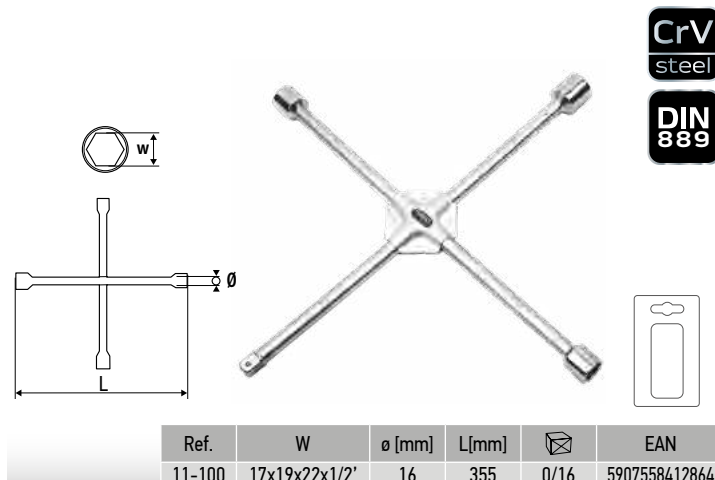

Ref.	W	ø [mm]	L[mm]	📦	EAN
11-100	17x19x22x1/2'	16	355	0/16	5907558412864

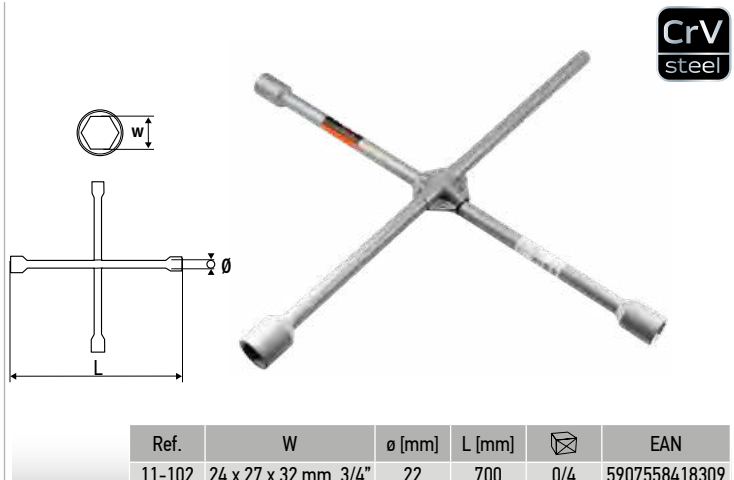

Ref.	W	ø [mm]	L [mm]	📦	EAN
11-102	24 x 27 x 32 mm, 3/4"	22	700	0/4	5907558418309



Ref.	W	📦	EAN
11-101	17x19x1/2'	6/12	5907558417135

Țișca do opon

Wrecking bar / Reifenlöffel / Монтажна автомобильная / Монтувалка / Gumibrancs szerelővas / Levier pentru pneu / Montážní páka na pneumatiky / Páka na pneumatiky / Țișca za pneumaticke / Svirts padangy montavimui / Lāpstiņa riepu montāžai / Rehvilusikas / Щанга за демонтаж на гуми / Podizač za montiranje guma / Kašika za gumu / Κουτάλα φανοποιίας / Llave cuchara para extraer ruedas / Leve per pneumatici / Ferramenta para rodas / Demonte-pneus / Breekijzer



Ref.	L[mm]	📦	EAN
11-111	400	10/20	5907558416619
11-112	500	10/20	5907558416626

Ściągacze do sprężyn

Spring pullers / Abzieher für Feder / Съёмные приспособления для пружин / Знімачі пружин / Rugóösszehúzó kézi / Ancore di arcuri / Stahováký pružin / Stahováký pružin / Izvlekači za vzmeti / Spyruoklių spaustai / Atsperu porėmata ierėce / Vedrutõmmitsad / Скобы за пружини / Skidači za opruge / Stega za oprugu / Εξωλέκας ελασπίων / Extractor de muelles / Pressori per molle / Ponta de aperto para molas / Extracteurs de ressorts / Trekkers voor veren



Ref.	Ra[mm]	📦	EAN
11-796	23-280	1/5	5907558436747



70-130
90-150
mm



- 70/130 mm, 90/150 mm Mercedes
- W123, W124, W126, W140, W202, W210
- W107, W114, W115, W116, W123, W124, W126, W129, W140, W201, W202, W203
- Opel / Vauxhall / Hyundai / Lada / Rover / Saab / Fiat / Ford / Mazda / Toyota / Nissan / Mitsubishi / Peugeot / Volo / VW

Ref.	Ra[mm]	📦	EAN
11-798	70-130; 90-150	1/2	5907558436761



Ściągacze do sprężyn

Spring pullers / Abzieher für Feder / Съёмные приспособления для пружин / Знімачі пружин / Rugóösszehúzókézi / Ancore de arcuri / Stahovky pružin / Stahovky pružin / Izvlekači za vzmeti / Spyruoklių spaustai / Atsperu noņemama ierīce / Vedrutāmmitsad / Скоба за пружину / Skidači za opruge / Stega za oprugu / Εξολκείς ελατηρίων / Extractor de muelles / Pressori per molle / Ponta de aperto para molas / Extracteurs de ressorts / Trekkers voor veren

125-212
88-160
65-125
mm



 125/212 mm, 8/160 mm, 65/125 mm.

 BMW: E31 - E67, MINI R50|R52|R53, Fiat, Alfa Romeo, Chrysler, Lancia, Ford, Mazda, Honda, Hyundai, Jaguar, Jeep, Kia, Mercedes C/E, Citroen, Peugeot, Opel, Vauxhall, Saab, Renault, Nissan, Infiniti, Dacia, Mitsubishi, Rover, Subaru, Toyota, Audi, Porsche, Skoda, VW, Volvo

Ref.	☒	EAN
11-797	1/1	5907558436754

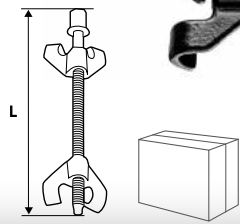
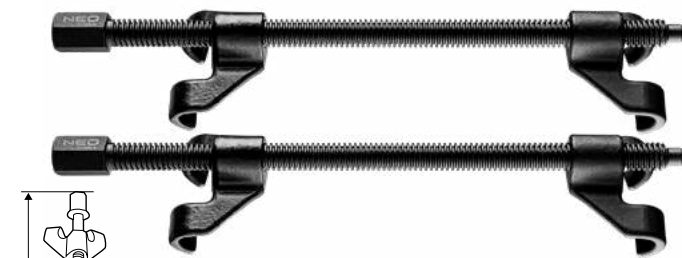

Ref.	L[mm]	☒	EAN
11-807	300	0/10	5907558418453

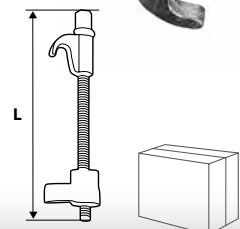
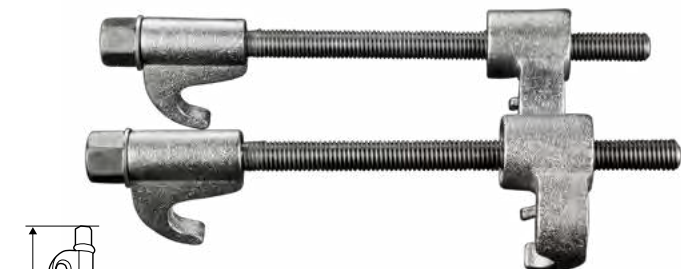

Ref.	L[mm]	☒	EAN
11-808	300	0/10	5907558418460

Dźwignia do przegubów

Lever for articulated joints / Hebel für Gelenke / Рычаг для шарниров / Вахсьль до шарнира / Gömbfejserelő villa / Levier de articulation / Podpěra kloubů / Páka k čarom / Vilice za zglobe / Vyrių svirtis / Šarniuru svira / Klambrikang / Лост за шарниру / Poluga za zglobove / Poluga za zglobove / Μοχλός μεντεσέδων / Palanca para rótulas / Leva per giunti articolati / Alavanca p. Articulações / Levier pour articulations / Hefboom voor spilverbindingen

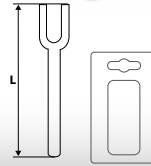

Ref.	L [mm]	☒	EAN
11-805	300	0/12	5907558418590
11-806	400	0/12	5907558418606

Zestaw łomów

Go-through pry bar set / Brechstangen-set / Набор монтажек / Набор ломів / Feszítővas készlet / Set de rânji de oțel / Sada pačidel / Súprava pačidiel / Komplet lomilk / Laužtuvų rinkinys / Laužu komplekts / Kangide komplekt / Комплект щанги / Set poluga / Garnitura poluga / Σετ κουτάλες / Juego de palancas / Set de leve da sforzo / Kit de pés-de-cabra / Jeu de pieds-de-biche / Set van breekijzers



CrV
steel x4

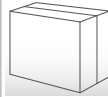

Ref.	L[mm]	☒	EAN
11-113	200, 300, 450, 600	0/10	5907558416633

Ściągacz do przegubów

Ball joint puller / Gelenkabziehvorrichtung / Съемник шарниров / Пристрій для зняття шарнірів / Gömbcsukló kinyomó / Extractor articulații sferice / Stahovák kloubů / Stahovák na guľavé čapy / Snetalec / Nuëmiklis šarnyrams / Novilcējs / Kuullidestõmmits / Скоба за болтове / Izvlekač / Radarpciger / Κροκοπάλαγο για καστανιές / Extractor de juntas de rótula / Estrattore di giunti a sfera / Ponta de aperto de articulações / Arrache-articulations / Trekker voor spilverbindingen



Ref.	ø [mm]	☒	EAN
11-801	20	0/20	5907558416527

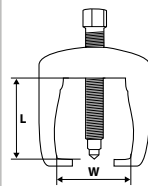

Ref.	L [mm]	W [mm]	☒	EAN
11-803	45	27	0/20	5907558418439
11-804	65	32	0/20	5907558418446

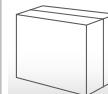

Ref.	ø [mm]	☒	EAN
11-802	19	0/20	5907558418422



Ściągacz do koła kierownicy

Steering wheel puller / Abzieher für Lenkradsrad / Съёмное устройство рулевого колеса / Знімач керма / Kormánykerék leszedő készlet / Ancoră de volan / Stahovák volantu / Stahovák volantu / Izvlekač za volan / Vairo traukės nuėmiklis / Stūres rata noņemama ierīce / Juhtratta tõmmits / Скоба за колелото на волана / Skidač kotača volana / Stega za upravljač / Εξωλέκας τιμονιού / Extractor de volante / Estrattore di volante / Ponta de aperto para volante / Extracteur de volant / Trekker voor stuurwiel



Ref.	📦	EAN
11-816	5/20	5907558419696

Ściągacz z siłownikiem

Hydraulic puler / Abzieher mit Servoantrieb / Съёмник с гидроприводом / Знімач із гидроприводом / Lehúzó hidraulikus rásegítéssel / Extractor cu dispozitiv de acționare / Hydraulický stahovák / Stahovák so servomotorom / Hidraulčni izvlekač / Hidraulinis nutraukiklis / Novlēcējs ar hidropiedziņu / Servomotorīga tōmmits / Инструмент за демонтаж с цилиндър / Skidač sa cilindrom / Alatka za skidanje sa hidraulikom / Υδραυλικός εξωλέκας / Extractor con accionador / Estrattore con cilindro / Extrator com accionador / Extracteur avec vérin / Hydraulische trekker

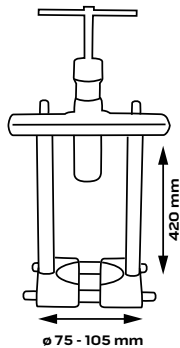

Ref.	📦	EAN
11-847	1/2	5907558436853

Ściągacz do piast

Wheel hub puller / Abzieher für Radnaben / Съёмное приспособление для ступиц / Знімач моточин / Kerékagy lehúzó készlet / Ancoră de butuc / Stahovák hlavy kola / Stahovák náboja / Izvlekač za pesta / Stebulių spaustai / Rumbu noņemama ierīce / Rattarummi tõmmits / Скоба за втулки / Skidač za glavčine / Stega za glavčini / Εξωλέκας πλήμης / Extractor de cubos de ruedas / Estrattore a bilanciare / Ponta de aperto / Extracteur de moyeux / Trekker voor naaf



Ref.	📦	EAN
11-811	5/20	5907558418484

Zestaw ściągaczy do drążków kierowniczych

Steering rods puler set / Abziehvorrichtungssatz für Spurstangen / Набор съёмников шаровых опор и рулевых наконечников / Набор знімачів до нервових тяг / Kormányösszekötő-gömbfejkinnyató készlet / Set trágátoare bare de comandă / Sada stahováků táhel řízení / Sada stahovákov tiahiel riadenia / Set izvlekačev za krmilne drogove / Guolinių atramų ir vairo traukių nuėmimo rinkinys / Stūres uzgaļu un sfērisko balstu novlēcēju komplekts / Roolivarda tõmmitsate komplekt / Комплект скобы за изваждане на кормилни щанги / Set skidača za upravljačke šipke / Pribor alatki za skidanje upravljačkog stalka / Σετ εξωλέκων σφαιρικών αρθρώσεων και κατευθυντήριων ραβδών / Juego de extractores de barras de dirección / Kit di estrattori per tiranti dello sterzo / Kit de extractores de barras de direção / Kit d'extracteurs de biellette de direction / Trekkers voor stuurstangen



Ref.	📦	EAN
11-799	1/2	5907558436778

Ściągacz dwuramienny i separator

Gear puller set / Abzieher mit zwei schenkeln und ausscheider / Съёмник универсальный с сепаратором / Знімач двоуплечевий і сепаратор / Csapágyelhúzó készlet / Extractor universal cu două brațe și separator / Sada dwuramennyj stahovák a oddělovač / Súprava dvooramennyj stahovák a separátor / Komplet dvokrakega snemalca in ločilnika / Dvišakių nuėmėjų rinkinys su separatorium / Divplecu novlēcēja un separatora komplekts / Kahesaruline tõmmits ja sепаратор / Комплект двураменна стяга със сепаратор / Set dvokraki skidač i separator / Garnitura dvokraka stega i separator / Εξωλέκας γενικής χρήσης με διαχωριστή / Juego de extractores de dos brazos y separador / Set separatore per cambio / Kit sacador de 2 garras e separador / Jeu d'extracteurs a 2 bras et separateur / Tweearmig trekker en separator



Ref.	📦	EAN
11-810	0/4	5907558416572



Ściągacz trójramienny

Three-arm puller / 3-Arm Abzieher / Съёмник с тремя захватами / Знімач триницепевий / Csapágyelhűző, háromkarmós / Extractor cu trei brațe / Трійрамений стahовák / Trojramenný stahovač / Trokraki snemalec / Trižiaunis nutraukiklis / Trīspļecu novilcējs / Kolmeharuline tōmmits / Трjраменна скоба / Trokraki izvlnač / Trokraki alat za skidanje / Εξολκείας με τρεις σιαγόνες / Extractor de tres brazos / Estrattore a tre griffe / Extractor de três braços / Arrache à trois branches / Driearmig trekker

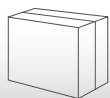
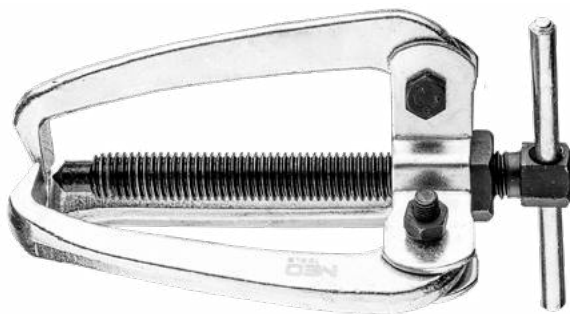

Ref.	L[mm]	☒	EAN
11-868	25	0/50	5907558420128
11-869	50	0/50	5907558420135
11-870	75	0/50	5907558420142

Ściągacz dwuramienny

2 jaws puller / Abzieher mit zwei schenkeln / Съёмник подшипников 2-х лопчатый / Знімач дволицепевий / Csapágyelhűző, kétkarmós / Extractor cu două brațe / Stahovák dvouramenný / Dvojramenný stahovák / Dvokraki snemalec / Nuemējas, divšakis / Divpļecu novilcējs / Kaheharuline tōmmits / Двоураменна скоба / Dvostruki odvajač / Dvokraka stega / Εξολκείας έναφαιρων τριβών με 2 σιαγόνες / Extractor de dos brazos / Estrattore a due griffe / Sacador de 2 garras / Extracteur a 2 bras / Tweearmig trekker

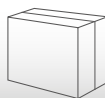

Ref.	L[mm]	☒	EAN
11-871	25	25/100	5907558420159
11-872	50	25/100	5907558420166
11-873	75	25/50	5907558420173

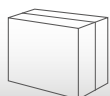

Ref.	L[mm]	☒	EAN
11-857	150	0/16	5907558416862
11-858	200	0/6	5907558416879
11-859	300	0/2	5907558416886

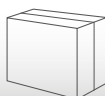

Ref.	L[mm]	☒	EAN
11-850	75	0/50	5907558416817
11-851	100	0/50	5907558416824
11-852	150	0/50	5907558416831

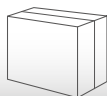

Ref.	L[mm]	☒	EAN
11-861	100	0/20	5907558416794
11-862	150	0/10	5907558416800

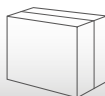

Ref.	L[mm]	☒	EAN
11-865	100	0/16	5907558418514
11-866	110	0/12	5907558418521
11-867	140	0/12	5907558418538



Ściągacz do łożysk

Gear puller / Lagerabziehvorrichtung / Съемник подшипников / Пристрій для зняття підшипників / Csapágyelhúzó / Extractor elicoidal / Stahovák ložisek / Stahovák dvojitenný / Snetalec / Guolių nuėtiklis / Novilcėjs gultniem / Hammasratta tōmmitis / Скоба за лагери / Izvlakač / Radapciger / Крiкoпáлaкo γιa áζφocεc τριβής / Extractor de cojinetes / Estrattore rapporti / Ponta de aperto para rolamentos / Arrache-roulements / Lageronderbank

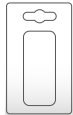
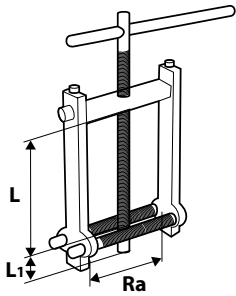

Ref.	L [mm]	L ₁ [mm]	Ra [mm]	☒	EAN
11-813	100	20	24 - 55	0/30	5907558418507



Ref.	Ra [mm]	☒	EAN
11-848	35-130	1/2	5907558436860

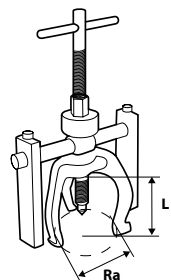

Ref.	L [mm]	Ra [mm]	☒	EAN
11-812	70	18 - 43	0/20	5907558418491

Zestaw do ściągania i instalowania łożysk

Bearing removal and fitting kit / Radlager-Werkzeug-Satz / Набор для снятия/установки подшипников / Набор для зняття та встановлення вальниць / Csapágyeszerelő szerszámkészlet / Set de dispozitive de scos si de instalat lagare / Sada pro vjtměnu a montáž ložisek / Súprava na demontáž a inštaláciu ložísk / Set za snemanje in montažo ležajev / Guolių montavimo komplektas / Gultņu novilkšanas un instalēšanas komplekts / Laagrite eemaldamise ja paigaldamise komplekt / Комплект за стязане и инсталлиране на лагери / Set za skidanje i instaliranje ležaja / Pribor za skidanje i instaliranje ležišta / Σετ τοποθέτησης/αφαίρεσης τριβέων / Juego para extraer e instalar rodamientos / Kit estrazione e montaggio cuscinetti / Jogo de ferramentas para remover e instalar rolamentos / Jeu d'arrache-roulement et de monte-roulement / Set voor demontage en installatie van lagers



Ref.	Ø [mm]	☒	EAN
11-690	50, 55, 60, 64, 67, 70, 72, 74, 75, 78, 82, 84, 88	1/2	5907558436624



Ref.	Ø [mm]	☒	EAN
11-691	18, 19, 20, 21, 22, 23, 24, 25, 26, 27, 28, 29, 30, 31, 32, 33, 34, 35, 36, 37, 38, 39, 40, 41, 42, 43, 44, 45, 46, 47, 48, 49, 50, 51, 52, 53, 54, 55, 56, 57, 58, 59, 60, 61, 62, 63, 64, 65	1/1	5907558436631



Indukcyjna grzałka do śrub

Induction bolt and screw heater / Induktives Heizgerät für Schrauben / Индукционный нагреватель / Нагрівач індукційний / Indukciós hevítő készlet / Incălzitor cu inducție pentru șuruburi / Indukčni ohrev šroubů / Indukčný ohrievač pre skrutky / Indukcijski grelnik za vijake / Indukcinis šildytuvas varžtams / Indukcijas šildītājs / Induktsioon-põldisoojendi / Индукционен нагревател за болтове / Indukcijski grijač za vijke / Indukcioni grejač za šrafove / Επαγωγικός θερμαντήρας / Calentador de inducción para tornillos / Riscaldatore ed induzione per viti / Aquecedor de indução para parafusos / Pistolet à chaleur inductive pour vis / Inductie dompelaar voor schroeven

700°C 1200W

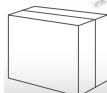

Ref.	📦	EAN
11-931	0/1	5907558436969

Zestaw do naprawy gwintów

Thread repairing kit / Gewindereparatursatz / Набор для восстановления резьбы / Набір для відновлення гвинтованих з'єднань / Menetjavító készlet / Set de rectificat fileturi / Sada pro opravu závitů / Súprava na opravu závitov / Set za popravilo navojev / Srigjimo įrankių rinkinys / Skrävju remontkomplekts / Keertparanduskomplekt / Комплект за ремонт на резби / Set za popravak navoja / Pribor za popravku šrafova / Σετ αποκατάστασης σπειρωμάτων μ5 / Juego de reparación de tornillos / Kit riparazione filetti / Jogo de ferramentas para reparacão de roscas / Kit de réparation de taraudages / Schroefdraad herstelset



CrV steel



Ref.	Ø	📦	EAN
11-901	M6	10/40	5907558419870
11-902	M8	10/40	5907558419887
11-903	M10	10/40	5907558419894
11-904	M12	10/40	5907558419900

Wkłady do naprawy gwintów

Thread repairing kit / Gewindereparatureinsätze / Набор резьбовых вставок / Набір для відновлення гвинтованих з'єднань / Menetjavító betét / Adausuri de rectificat fileturi / Vložky pro opravu závitů / Vložky na opravu závitov / Set za popravilo navojev / Srigjimo galvučių rinkinys / Leliktni vītnu remontam / Keertparandustüübid / Елементи за ремонт на резби / Umetci za popravak navoja / Umetak za popravku / Σετ ένθετα σπειρωμάτων / Repuestos para reparación de tornillos / Kit riparazione filetti / Cartuxos para reparacão de roscas / Inserts de réparation de taraudages / Inzetdelen voor schroefdraad herstel



Ref.	Ø	N	📦	EAN
11-905	M5	20	50/250	5907558419917
11-906	M6	20	50/250	5907558419924
11-907	M8	20	50/250	5907558419931
11-908	M10	20	50/250	5907558419948
11-909	M12	10	50/250	5907558419955

Narzynki i gwintowniki

Tap and die set / Schneideisen und Gewindebohrer / Плашки и метчики / Позначники и плашки, набір / Menetkészítő készlet / Set scule tăiere filet interior și exterior / Závítnice a závitníky / Súprava závitníkov / Garnitura vreznikov in nareznikov navoja / Sriegjovės ir sriegikliai / Vitngriežu komplekts / Kraani ja valuvormi komplekt / Метчици и плашки / Nareznice i ureznicne set / Set ureznika i nareznika / Ελικοκόπιτες και κολλαούζα / Cojinetes y machos de roscar, juego / Madreviti e maschi / Cassonetes e roscas / Filières et tarauds / Snijplaat en schroefdraad snijtoestel

x110



M2x0,4; M3x0,5; M4x0,7; M5x0,8; M6x0,75; M6x1,0; M7x0,75; M7x1,0; M8x0,75; M8x1,0; M8x1,25; M9x0,75; M9x1,0; M9x1,25; M10x0,75; M10x1,0; M10x1,25; M10x1,5; M11x0,75; M11x1,0; M11x1,25; M11x1,5; M12x0,75; M12x1,0; M12x1,25; M12x1,5; M12x1,75; M14x1,0; M14x1,25; M14x1,5; M14x2,0; M16x1,0; M16x1,5; M16x2,0; M18x1,5;



M2x0,4; M3x0,5; M4x0,7; M5x0,8; M6x0,75; M6x1,0; M7x0,75; M7x1,0; M8x0,75; M8x1,0; M8x1,25; M9x0,75; M9x1,0; M9x1,25; M10x0,75; M10x1,0; M10x1,25; M10x1,5; M11x0,75; M11x1,0; M11x1,25; M11x1,5; M12x0,75; M12x1,0; M12x1,25; M12x1,5; M12x1,75; M14x1,0; M14x1,25; M14x1,5; M14x2,0; M16x1,0; M16x1,5; M16x2,0; M18x1,5

Ref.	📦	EAN
11-915	1/3	5907558436907



M3-M12

DIN223
DIN352

32
PCS

HSS

Ref.	📦	EAN
12-915	1/10	5907558483291

Oprapka do narzynek

Handle for die / Schneideisenfassung / Вороток для плашек / Вороток для плашки / Menetkészítő hajtós / Míner filiera / Objímka závitnic / Vratidlo na očká / Ročaj za nareznicke navoja / Sriegjovės rėmas / Vitngriežu turėtājs / Valuvormi käepide / Върток за плашки / Držac nareznica / Okretac nareznika / Χειρολαβή για ελικοκόπιτη / Terraaja de cojinetes / Impugnatura per filettatrice / Armadura p. Cassonetes / Monture de filière / Kader voor snijplaten

M3-M12 #45 STEEL TWISTING FORCE HIGH STRENGTH

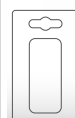

Ref.	📦	EAN
12-909	10/100	5907558483314



Pokrętko do gwintowników

Handle for hand tap / Gewindebohrergriff / Вороток для метчиков / Вороток для позначника / Menetűró hajtóvas / Manivelă burghiu manual / Vratidlo k závitníkům / Vratidlo na závitníky / Ročaj za vreznike navoja / Rankena sriegkliams / Vītņgrieža turētājs / Käsikraani käepide / Върток за метчик / Držič Ureznica / Okretac ureznika / Χειρολαβή για κολλούζο / Manivela para machos de roscar / Impugnatura per filetto / Chave para machos / Tourne-à-gauche / Draaiknop voor draadtap



Ref.	📦	EAN
12-908	25/100	5907558483321

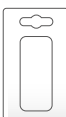

Ref.	📦	EAN
12-910	10/100	5907558483307

Przewody rozruchowe

Booster cables / Akku-Zusatzleitungen / Стартовые провода / Шнури аварійного пуску акумулятора / Indítókábel róz / Conductor de avarie pentru acumulator / Kabely pro nouzové startování k akumulátoru / Pomocné káble do akumulátora pre núdzový štart / Vžigalni kabli / Automobili užvedimo laidai / Palaišanas vadi akumulatoram / Aku avarijuhtmed / Аварийни проводници за акумулатор / Rezervni kablovi za akumulator / Hitni kabl za akumulator / Καλώδια έκτακτης ανάγκης για ηλεκτρικό συσσωρευτή / Cables puente para la batería / Cavi di emergenza per la batteria / Cabos de emergência para bateria / Câbles de démarrage pour batterie



Ref.	A max	📦	EAN
11-834	200	0/6	5907558436815
11-836	600	0/5	5907558436822

Tester akumulatorów

Battery load tester / Batterietester / Тестер батареу / Тестер акумулатора / Akkumulátor tesztelő / Tester de încercare a bateriei / Tester baterii / Tester batterie / Tester akumulatorja / Akkumulatoriaus baterijos testeris / Akumulatoru bateriju testeris / Aku tester / Тестер на батеријата / Ispitivač baterije / Испитивач батерије / Ελεγκτής φορτίου μπαταρίας / Comprobador de carga de batería / Tester di carico della batteria / Testador de carga da bateria / Testeur de charge de batterie / Acculaadtester

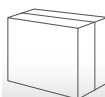

Ref.	A max	📦	EAN
11-984	100	1/10	5907558452402

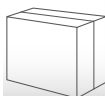

Ref.	A max	📦	EAN
11-985	125	1/10	5907558452419

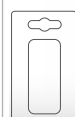

Ref.	📦	EAN
11-986	6/36	5907558452419



Prostownik

Car battery charger / Stromrichter / Выпрямитель / Выпрямляч / Egyenirányító / Redresor auto / Usměňovač / Usměňovač / Usmernik / Įkroviklis / Akumulatora lādētājs / Alaldi / Τοκοσπρωμεν / Ispravljáč / Ispravljáč / Ανορθωτής / Rectificador / Radriizzatore carica batterie / Gelijkrichter

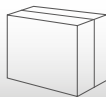
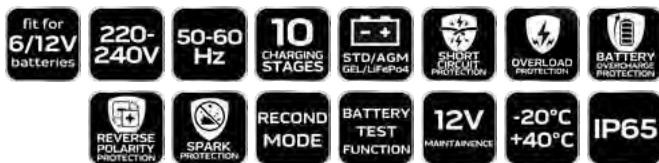

Ref.	[A/W]	Ah	☒	EAN
11-891-1	4/70	3-120	1/10	5907558495126
11-892-1	6/100	3-150	1/10	5907558495126
11-893-1	10/160	3-200	1/10	5907558495140

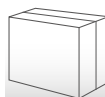

Ref.	☒	EAN
11-890	0/10	5907558463279

Próbnik elektryczny samochodowy

Car voltage tester / Kfz-Spannungsprüfer V / Индикатор напряжения / Индикатор напруги автомобільний / Járműfáziszeruza / Sonda de luat probe la instalații electrice la automobile / Zkoušečka napětí autoelektrikářská / Autoskúšačka / Preizkuševalac napetosti za avtomobile / Elektroninis testeris automobiliams / Automašinas elektrības testeris / Auto elektritester / Автомобилен фазомер / Električni ispitivač napona / Automobiliški električni tester / Συσκευή ένδειξης τάσης / Probador eléctrico para coches / Tester per auto / Testador de tensão para carros / Testeur électrique automobile / Elektrische wagen meetkop

6-24V

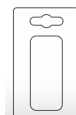

Ref.	☒	EAN
11-832	12/240	5907558420418



Zestaw blokad rozrządu

Timing tool set / Nockenwellen-Arretierwerkzeugsatz / Набор фиксаторов распределителя для установки фаз ГРМ / Набор стопорів для розподільвальних валів / Vezérműtengely blokkoló készlet / Set de blocarea distribuției / Sada blokovací pro opravu rozvodů / Súprava blokad rozvodov / Set blokad gredi / Paskirstymo velenėlių fiksavimo komplektas / Sadales mehānismu fiksatoru komplekts / Jaotuse blokeerimise komplekt / Комплект блокировки на газораспределителе / Set alata za blokiranje radilice / Pribor za blokadu razvođenja / Set συγκράτησης κινωδωφόρων αξόνων / Kit de bloqueo de la correa de distribución / Attrezzi di blocco dell'albero a camme / Conjunto de bloqueios de engrenagem de distribuição / Ensemble de verrouillage de distribution / Set van distributievergrendeling

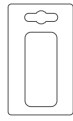

1.2D TDI PD: ANY, AYZ
1.4D TDI PD: AMF, ATL, BHC
1.9D TDI PD: AJM, ANU, ARL, ASZ, ATD, ATJ, AUY, AVB, AVF, AWX, AXR, BSW, BTB, BVK

Ref.	📦	EAN
11-300	10/40	5907558436051



TDI
VAG



TDI
VAG



Audi: A1 (10-15), A2 (00-06), A3 (01-13), A4/Allroad (01-16), A5 (08-15), A6 (11-14), TT (08-14), Q3 (11-15), Q5 (08-15), A6 (10-14)
Dodge: Caliber (06-11); Ford: Galaxy (02-06);
Mitsubishi: Grandis (05-10), Lancer (05-10), Outlander (07-10)
Seat: Alhambra (00-15), Altea/Altea XL (04-15), Cordoba (02-09), Ibiza (02-15), Leon (00-13), Toledo (04-11)
Skoda: Fabia (00-14), Fabia II (07-15), Octavia (00-10), Octavia II (04-15), Praktik (10-15), Rapid (11-15), Roomster (07-15), Superb (02-08), Superb II (08-15), Yeti (09-14)
VW: Amarok (10-16), Beetle (02-15), Bora (02-08), Caddy/Maxi (03-15), EOS (06-15), Fox (05-11), Golf (02-15), Golf Plus (05-14), Jetta (05-15), Lupo (02-05), Passat/CC (02-15), Polo (99-14), Scirocco (08-14), Sharan (02-15), Tiguan (07-15), Touran (03-15), Transporter (03-18)



Kody silników / Engine codes / Коды двигателя:

1.2D TDI CR: CFWA
1.4D TDI PD: AMF, BAY, BMS, BNM, BNV, BWB
1.6D TDI CR: CAYA, CAYB, CAYC, CAYD, CAYE, CLNA
1.9D TDI PD: AJM, ANU, ARL, ASZ, ATD, AUY, AVB, AVF, AVQ, AWX, AXB, AXC, AXR, BJB, BKC, BLS, BLT, BMT, BPZ, BRM, BRR, BRS, BRU, BSU, BSV, BSW, BTB, BVK, BXE, BXF, BXJ
2.0D TDI CR/TDI PD: AZV, BDJ, BDK, BEW, BGW, BHW, BKD, BKP, BKQ, BLB, BMA, BMM, BMN, BNP, BMR, BNA, BPW, BRA, BRC, BRD, BRE, BRF, BRT, BSS, BST, BSY, BUY, BUZ, BVA, BVE, BVF, BVG, BVH, BWC, BVV, CAAA, CAAB, CAAC, CAAD, CAAE, CAGA, CAGB, CAGC, CAHA, CAHB, CBAA, CBAB, CBAC, CBBA, CBBB, CBDA, CBDB, CBDC, CBEA, CCHA, CCHB, CDBA, CDCA, CEGA, CFCA, CFFA, CFFB, CFFD, CFFE, CFGB, CFGC, CFHA, CFHB, CFHC, CFHD, CFHE, CFHF, CFJA, CGLA, CGLB, CGLC, CGLD, CJAA, CJCA, CJCB, CJCC, CLCA, CLCB, CLJA, CLLA, CNEA, ECD, ECD/BSY, ECD/BYL, ECE/BWD
OEM:
Dodge: 9882, 9883
Ford: 310-085/23-059, 303-1054
Mitsubishi: MB995206, MB995208, MB995209
VAG: T10100, T10050, 3359/T20102, T10115, T10060A/T40098, T20167

Ref.	📦	EAN
11-301	10/40	5907558436068



TDI
VAG



AUDI: A1, A3, A4 (B8), A5, A6 (C6, C7), TT, Q3, Q5
VW: Golf V-VI, Passat B6, B7, Polo, Jetta V-VI, Scirocco III, Beetle II, Caddy, Touran, Sharan II, T5
SKODA: Fabia, Roomster, Practice, Octavia II, Superb II, Yeti
SEAT: Ibiza, Leon, Exeo, Altea, Alhambra II



Kody silników / Engine codes / Коды двигателя:
1,6 TDI CR (> 2009): CAYB, CAYC
2,0 TDI CR (> 2007): CAAA, CAAB, CAAC, CBAB, CBBB, CBAA, CFFB, CAGA, CAHA, CAGB, CAHB, CAGC, CCHA, CAVA, CBDA, CBDD, CBAC, CBDC
OEM: T20102 | U40074 | 3359 | T10050 | T10100 | T10264 | T10265 | T40098 | T10051 | T10052 | T10255

Ref.	📦	EAN
11-302	1/5	5907558436075



TDI
VAG



Audi: A4 2,7 TDI (05-09); A4 Quattro 2,0 TDI (05-06); Q7 3,0 TDI (06-09)
Volkswagen: Touareg 3,0 V6 TDI (08-); Phaeton 3,0 V6 TDI (06-); Diesel 2,7 TDI, 2,0 TDI 3,0 TDI



Kody silników / Engine codes / Коды двигателя
2.7 TDI V6: BBP, BSG, CAMA, CAMB, CANA, CANS, CAND, CGKA, CGKB
3.0 TDI V6: ASB, BKN, BKS, BMK, BMZ, BNG, BUG, BUN, CAPA, CARA, CARB, CASA, CASB, CASC, CATA, CCMA, CCWA, CCWB, CDYA, CDYB, CDYC, CEXA,
4.0 TDI V8: ASE
OEM: T40062 | T40061 | T40049 | 3359 | T40058 | T40060 | 3242

Ref.	📦	EAN
11-303	1/5	5907558436082



VAG



Benzyna/Gasoline / Бензин: 1,2 6V/12V / 1,4 16V / 1,6 16V / 1,4FSI / 1,6FSI
Diesel: 1,2TDI / 1,4TDI / 1,9TDI / 2,0TDI / 2,5 V6 TDI / 3,3 V8 TDI / 2,0TDI (PD oraz CR) / 1,6 TDI CR

Kody silników / Engine codes / Коды двигателя

ANY, ASZ, ATD, AMF, ATL, BHC, AXR, AVB, AVX, AWX, AMF, BMS, BNM, BNV, ANU, ARL, AUY, BTB, BVK, BJB, BKC, AZV, BKD, AXB, AXC, BDJ, BST, AJM, AYZ, BWB, BAY, AXG, AXL, AYC, AVQ, BMP, BRM, BRU, BSU, BXE, BXF, BMM, BDK, AZU, BMN, ATJ, BGW, BHW, ACV, AHY, AJ
OEM: T10123 | T10120 | 3458 | 3418 | 2065A | 3366 | T10098 | T10121 | 3242 | T10050 | T10100 | T10060A | T10020 | T10008 | T40011 | 3359 | 2064 | 3369 | T10016 | T10264 | T10265

Ref.	📦	EAN
11-304	1/4	5907558436099



VAG



AUDI: A3, S3, A5, A6, TT (03-11), SEAT: Ibiza, Leon, Altea, Exeo (04-11)
SKODA: Fabia II, Octavia II, Roomster, Superb II (04-11),
VW: Golf, Golf Plus, Jetta, Eos, Scirocco, Tiguan, Touran, Passat (03-11)



Kody silników / Engine codes / Коды двигателя:

2.0FSI: AWA, AXW, BHD, BLR, BLX, BLY, BMB, BVX, BVY, BVZ
2.0TFSI: AXH, BGB, BHZ, BPG, BPJ, BPY, BUL, BWA, BWE, BWJ, BWT, BYD, BYK, BZC, CDLA, CDLB, CDLC, CDLD, CDMA
OEM: T10020 | T10252 | T10092 | T10115 | T10060A | 3366 | T40011

Ref.	📦	EAN
11-306	1/10	5907558436112



Zestaw blokad rozrządu

Timing tool set / Nockenwellen-Arretierwerkzeugsatz / Набор фиксаторов распределителя для установки фаз ГРМ / Набор стопорів для розподільвальних валів / Vezérműtengely blokkoló készlet / Set de blocarea distribuției / Sada blokovací pro organy rozvodů / Súprava blokad rozvodov / Set blokad gredi / Paskirstymo velenėlių fiksavimo komplektas / Sadales mehānismu fiksatoru komplekts / Jaotuse blokeerimise komplekt / Комплект блокировки на газораспределителе / Set alata za blokiranje radilice / Pribor za blokadu razvodnja / Set συγκράτησης κλιβακοφόρων αξόνων / Kit de bloqueo de la correa de distribución / Attrezzo di blocco dell'albero a camme / Conjunto de bloqueios de engrenagem de distribuição / Ensemble de verrouillage de distribution / Set van distributievevergrendeling



Audi: A1 (10-15), A3 (03-13)
 Seat: Alhambra (10-15), Altea/Altea XL (08-15), Ibiza/Cordoba (08-12), Leon (07-13), Toledo (07-15)
 Skoda: Fabia II (07-15), Octavia II (04-15), Praktik (10-15), Rapid (12-15), Roomster (06-15), Superb II (09-14), Yeti (09-14)
 VW: Beetle (11-15), Caddy/Caddy Maxi (10-15), EOS (06-12), Golf (03-12), Golf Plus (03-14), Golf V Estate (07-13), Golf VI Cabriolet (10-15), Jetta (06-14), Passat (05-11), Polo (02-14), Scirocco (08-12), Tiguan (07-12), Touran (03-15)



Kody silników / Engine codes / Коды двигателя:

1.2 TFSI:CBZA, CBZB, CBZC

1.4 FSI:AXU, BKG, BLN

1.4 TFSI:BLG, BMY, BWK, CAVA, CAVB, CAVC, CAVD, CAVE, CAVF, CAXA, CAXC, CDGA, CSMA

1.6 FSI:BAG, BLF, BLP, BTS

OEM VAG: T10170, T10171A, T40011, T10340, T10414

Ref.	📦	EAN
11-305	1/10	5907558436105



AUDI: A1 - A1 Sportback - A3 - A3 Sportback - A3 CABRIO - S1 - S1 Sportback
 SEAT: Alhambra - Altea - Altea XL - Ibiza - Leon - Cordoba - Toledo
 SKODA: Octavia II - Praktik - Roomster - Superb II - Yeti - Yeti Outdoor - RAPID - Rapid Spaceback - Superb II
 VW: Beetle - Caddy - Caddy Maxi - Eos - Golf Plus - Golf V - Golf V Estate - Golf VI - Golf VI Cabrio - Golf VI Estate - Jetta - Passat - Polo - Scirocco - Sharan - Tiguan - Touran - CC



Kody silników / Engine codes / Коды двигателя:

1.2 FSI/TFSI: CBZA - CBZB - CBZC

1.4 TSI/1.4 / 1.6 FSI: AXU - BAG - BKG - BLF - BLG - BLN - BLP - BMY - BTS - BWK CAXA (03-)

OEM VAG: T10340, T10414, T10171A, T40011, T10170, VAS6079, T10341

Ref.	📦	EAN
11-307	1/5	5907558436129



Audi: A3 (2013-)
 Seat: Mii (2012-), Leon (2012-), Toledo (2012-)
 Skoda: Citigo (2012-), Octavia (2013-), Rapid (2012-)
 VW: Up (2012-) and Polo mk5 (2014-), Golf VII (2012-), Jetta (2012-)



1.0 Ecofuel, Ecomotive, Bluemotion, Green Tech

CHYA, CHYB, CPGA

1.2 TFSI: CJZA, CJZB

1.4 TFSI: CMBA, CXXA, CHPA

1.4 TGI: CPWA

1.4 TSI Multi Fuel CPVA

1.4 Hybrid CRJA

OEM VAG: T10340, T10477, T10476, T10499, T10494, T10487

Ref.	📦	EAN
11-338	0/2	5907558451214



116i E81/82/87/88 (07-12), 118i E81/82/87/88 (06-14), 120i E81/82/87/88 (06-14)
 BMW 3 Series: 316i E90/91/92/93 (07-11), 318i E90/91/92/93 (07-13), 320i E90/91/92/93 (07-14)
 BMW 5 Series: 520i E60/61 (07-10)



Kody silników / Engine codes / Коды двигателя:

N43: B16A/AA, B16AA, B16AA/00, B20A, B20A/AA, B20AA, B20AY, B20KQ, B20U0

OEM BMW: 11.8.690 (11.8.691/11.8.692/11.8.693), 11.9.340 (11.9.341/11.9.342), 11.8.710 (11.8.711/11.8.712), 11.3.340, 11.5.120, 11.8.700

Ref.	📦	EAN
11-310	1/5	5907558436136



BMW 1 Series: 118i E81/82/87/88 (04-14), 120i E81/82/87/88 (04-14)
 BMW 3 Series: 316i/ti Compact E46 (01-07), 318i/ti Compact E46 (01-07), 318i E90/91/92/93 (05-12), 320i (E90/91/92/93 (05-14)
 BMW 5 Series: 520i E60/61 (07-10)
 BMW X Series: X1 E84 sDrive 18i (10-12), X1 E84 xDrive 18i (10-12), X3 E83 2.0 (05-10)
 BMW Z Series: Z4 2.0 E85/86 (04-09),



Kody silników / Engine codes / Коды двигателя:

2.0: N42 B18A, N42 B20A, N46 B18, N46 B20, N46 B20B, N46T B20, N46T B20B, N46T B20BZ, N46T B2002, N46T B202

OEM BMW: 11 9 310 | 11 9 320 | 11 9 302 | 11 9 301 | 11 9 290 | 11 9 302 | 11 9 340 | 11 9 390 | 11 9 350 | 11 9 270 | 11 2 300 | 11 9 190 | 11 9 330

Ref.	📦	EAN
11-313	1/5	5907558436167



BMW 1 Series: 118i E81/82/87/88 (04-14), 120i E81/82/87/88 (04-14)
 BMW 3 Series: 316i/ti Compact E46 (01-07), 318i/ti Compact E46 (01-07), 318i E90/91/92/93 (05-12), 320i (E90/91/92/93 (05-14)
 BMW 5 Series: 520i E60/61 (07-10)
 BMW X Series: X1 E84 sDrive 18i (10-12), X1 E84 xDrive 18i (10-12), X3 E83 2.0 (05-10)
 BMW Z Series: Z4 2.0 E85/86 (04-09),



Kody silników / Engine codes / Коды двигателя:

2.0: N42 B18A, N42 B20A, N46 B18, N46 B20, N46 B20B, N46T B20, N46T B20B, N46T B20BZ, N46T B2002, N46T B202

OEM BMW: 11.9.301, 11.9.303, 11.9.310, 11.9.320, 11.9.390

Ref.	📦	EAN
11-312	1/5	5907558436150



Zestaw blokad rozrządu

Timing tool set / Nockenwellen-Arretierwerkzeugsatz / Набор фиксаторов распредела для установки фаз ГРМ / Набор стопорів для розподільвальних валів / Vezérműtengely blokkoló készlet / Set de blocarea distribuției / Sada blokovací pro opravu rozvodů / Súprava blokad rozvodov / Set blokad gredi / Paskirstymo velenėlių fiksavimo komplektas / Sadales mehānismu fiksatoru komplekts / Jaotuse blokeerimise komplekt / Комплект блокировки на газораспределении / Set alata za blokiranje radilice / Pribor za blokadu razvodjenja / Σετ συγκράτησης κινωδοκροφών αξόνων / Kit de bloqueo de la correa de distribución / Attrezzi di blocco dell'albero a camme / Conjunto de bloqueios de engrenagem de distribuição / Ensemble de verrouillage de distribution / Set van distributievergrendeling

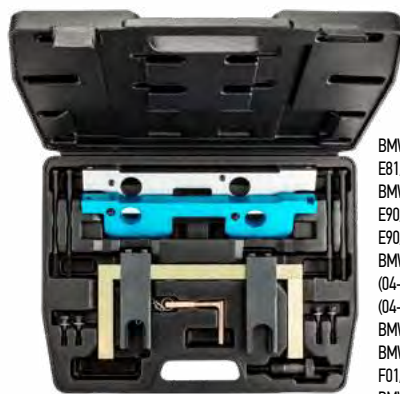

BMW 1 Series: 125i E88 (07-13), 128i E82/88 (07-08), 130i E81/87 (05-12), 135i/S E82 (07-11), M Coupe (11-12)
 BMW 3 Series: 323i E90/91/92/93 (04-11), 325i E90/91/92/93 (05-13), 328i E90/91/92/93 (04-08), 330i E90/91/92/93 (04-14), 335i E90/91/92/93 (05-11)
 BMW 5 Series: 523i/Li E60/61/F10/11 (04-11), 525i E60/61 (04-10), 528i E60/61/F10/11 (06-11), 530i E60/61/F10/11 (04-13), 535i E60/61 (06-08)
 BMW 6 Series: 630i E63/64 (04-11)
 BMW 7 Series: 730i E65/66 F01/02/04 (04-11), 740i F01/02/04 (08-12)
 BMW X Series: X1 E84 xDrive 20i (11-14), X1 E84 sDrive 20i (11-14), X1 E84 xDrive 28i (11-14), X1 E84 3.0 xDrive 25i (10-11), X1 E84 xDrive 28i (09-11), X3 F25 20i (11-14), X3 E83 2.5Si (06-10), X3 E83 3.0i/Si (06-10), X3 F25 3.0 xDrive 28i (11-13), X5 E70 3.0Si/xDrive 30i (06-10), X6 E71/72 3.0 xDrive 35i (08-10)
 BMW Z Series: Z4 E85/86 2.5i/Si (05-09), Z4 E85/86 3.0i/Si (05-09), Z4 E89 2.5 sDrive 23i (09-11), Z4 E89 3.0 sDrive 30i (09-11), Z4 E89 3.0 sDrive 35i (09-13)



Kody silników / Engine codes / Коды двигателя:
 N52/N52K: B25A, B25A/O1, B25AE, B25AF, B25BE, B2501, B2502, B25U1, B30/O2, B30A, B30A/O1, B30AE, B30AF, B30O2, B30U1 N53/N54: B25A, B30A, B30A/AA, B30A/OO, B30A/TO, B3000, B30TD, B30UO
 OEM BMW: 110300 | 114280 | 114281 | 114282 | 114283 | 114290 | 118520

Ref.	📦	EAN
11-311	1/2	5907558436143



BMW:
 118d / 120d: E87:
 318d / 318td Compact / 320td Compact / 320d / 330d: E46:
 316i: 316ti, 318ci, 318ti, 320i E90/E91:
 318i: 320i E90/E91/E92/E93: 520d / 525d / 530d: E39:
 318tds / 318tds Compact (1994-2000) / 325td / tds (1991-99): E36
 525d / 530d / 535d: E60/E61:
 525td / tds (1991-2003): E34/E39
 635d: E63:
 725tds (1991-2003) M47 / M47 TU / T2 / M57 TU/T2: E38:
 730d: E38/E65/E66:
 X3: 2.0i d / 3.0i d E83:
 X5: 3.0i d E53/E70:
 Land-Rover
 Range Rover: 2.5 DT (1994-2002)
 Range Rover: 3.0 TD6 (2002-2006)
 Freelander: 2.0 TD4 (2002-2006)



Kody silników / Engine codes / Коды двигателя:
 M41, M51, M47 - M47 TU/T2, M57 TU/T2: 2.0i / 3.0i - 1998 - 2008
 OEM BMW: 11 2 300 | 11 3 320 | 11 3 340 | 11 3 360 | 11 5 180 | 11 6 080 | 11 6 320 | 11 6 321 | 11 6 322 | 13 5 120 | 13 5 190 | 13 5 191 | 13 5 192
 OEM Land Rover: LRT-12-108 | LRT-12-112 | LRT-12-115 | LRT-12-114 | LRT-12-119
 OEM Opel: KM-6267 | KM-6269 | KM-6268 | KM-813 | KM-823

Ref.	📦	EAN
11-316	1/2	5907558436198



BMW: N42 / N46 / N46T - Valvetronic
 Seria 1: E87 118i/120i (04-10)
 Seria 3: E46 316i/316ti Compact, 318ti Compact (01-05), 318i (01-07), E90 318i (05-08)
 Seria 5: E90 520i (04-08), X3 E83 2.0i (05-09)



Kody silników / Engine codes / Коды двигателя:
 N46, B18, B20B, B20, N42, B18A, B20A, N46T
 OEM BMW: 11 3 350 | 11 9 293 | 11 9 292 | 11 9 291 | 11 9 340 | 11 5 120 | 11 9 270 | 11 9 190

Ref.	📦	EAN
11-314	1/5	5907558436174

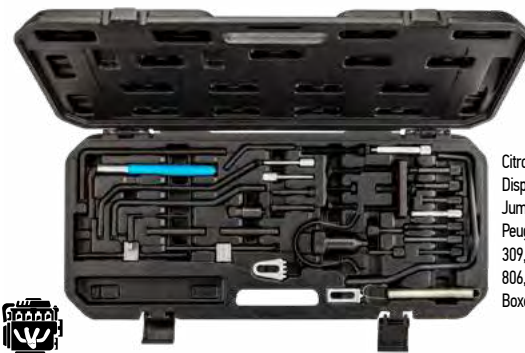

Citroen: AX, ZX, XM, Xsara, Xantia, Dispatch, Evasion, Berlingo, Jumpy, C2, C3, C5 |
 Peugeot: 106, 205, 206, 305, 306, 307, 309, 405, 406, 406 Coupe, 605, 607, 806, 807, Express, Expert, Partner, Boxer.



Silniki / Engines / Двигатели:
 Benzyna / Gasoline / Бензин: 1.0 / 1.1 / 1.4 / 1.6 / 1.8 / 2.0 / 2.0 HPI
 Diesel: 1.8 / 1.9 / D / TD 1.4 / 2.0 / 2.2 / HDI 2.1 / 2.2 / 2.5 / TD
 OEM: 4 4507-TJ | 0132X | 9767.89 | 0132X1Z | 0132Q | 5711-TA | 4507-TB | 0132R | 9767.27 | 7014-TM | 4507-TA | 0132QZ | 0189-C | 0153G | 0153Y | 0153N | 0188D | 7017-TR | 0118X | 7004-TG | 7014-TJ | 7017-TR | 0132AB | 4527-TS2 | 5711-TD | 0189-B | 5711-TC | 9041-TZ | 0188-H | 4527-T-S1 | 0132AJ2 | 0188M | 4533-TAC2 | 0132AJ1 | 4533TAC1 | 0189-A | 0189AZ | 0189-L | 0188Y | 0288D | 7099-TM | 7014-TJ | 0188P/P2 | 7015T | 0134AF | 0188F | 9044

Ref.	📦	EAN
11-320	1/4	5907558436211



BMW 1.6 2.0 3.0 d
 118d E81; 118d E87 - (2006-2010)
 120d E81; 120d E82; 120d E87 - (2006-2010)
 123d E81; 123d E82; 123d E87 - (2007-2010)
 318d E90; 318d E91 - (2007-2010)
 320d E90; 320d E91; 320d E92 - (2005-2010)
 520d E60; 520d E61 - (2006-2008)
 X3 2.0d E83 - (2007-2010)



Kody silników / Engine codes / Коды двигателя:
 N47; N47S D20A; N57
 OEM BMW: 11 6 480 | 11 8 760 | 11 8 740 | 11 8 741 | 118742 | 11 5 320

Ref.	📦	EAN
11-315	1/10	5907558436181



BMW 3 Series: 318tds E36 (94-99), 318tds Compact E36 (95-00), 325td/tds E36 (91-99)
 BMW 5 Series: 525td/tds E34 (91-96), 525td/tds E39 (97-03)
 BMW 7 Series: 725tds E38 (96-02)
 Land Rover: Range Rover (94-02)
 Vauxhall/Opel: Omega-B (94-01)



Kody silników / Engine codes / Коды двигателя:
 1.7D: M41/174T1 2.5D: M51/256T1, M51/256T1L 2.5D Turbo: M51, 256T, 25DT, X25DT
 OEM BMW: 11 2 150, 13 5 062, 11 3 340, 11 3 360, 11 3 320, 13 5 120, 11 2 300
 OEM Land Rover: LRT-12-118, LRT-12-112, LRT-12-114, LRT-12-115, LRT-12-119, LRT-12-108
 OEM Vauxhall/Opel: KM-819, KM-826, KM-823, KM-822, KM-811, KM-825, KM-813

Ref.	📦	EAN
11-317	1/2	5907558436204



Zestaw blokad rozrządu

Timing tool set / Nockenwellen-Arretierwerkzeugsatz / Набор фиксаторов распределителя для установки фаз ГРМ / Набор стопорів для розподільвальних валів / Vezérműtengely blokkoló készlet / Set de blocarea distribuției / Sada blokovací pro opravu rozvodů / Súprava blokad rozvodov / Set blokad gredi / Paskirstymo velenėlių fiksavimo komplektas / Sadales mehānisma fiksatoru komplekts / Jaotuse blokeerimise komplekt / Комплект блокировки на газораспределителе / Set alata za blokiranje radilice / Pribor za blokadu razvođenja / Set συγκράτησης κλωβακοφόρων αξόνων / Kit de bloqueo de la correa de distribución / Attrezzi di blocco dell'albero a camme / Conjunto de bloqueios de engrenagem de distribuição / Ensemble de verrouillage de distribution / Set van distributievevergrendeling



RENAULT: Clio, Clio Sport, Twingo, Kangoo, Megane, Scenic, Laguna, Espace, Safrane, Spider, R19, Master, Trafic
OPEL: Arena, Movano
VOLVO: S40, V40
Gasoline engine: 1.2 / 1.4 / 1.6 / 1.7 / 1.8 / 2.0 / 2.2 / 1.4 16V / 1.6 16V / 1.8 16V / 2.0 16V / 2.5 20V
Diesel Engine: 1.9 / 2.5 / 2.8



Kody silników / Engine codes / Коды двигателя:
B16, B18, B20, N7Q, N7U, K4J, K4M, F4P, F4R, D7F, E5F, E7F, E7J, K7M, F1N, F3N, F3P, F2R, F3R, F7P, F7R, J5R, J7R, J5T, F8M, F8Q, G8T, J8S, F9Q, S8U, S9U, S9W
OEM: MOT1348 | MOT1312 | MOT1135-01 | MOT1384 | MOT1337 | MOT1496 | MOT910-1 | MOT910 | MOT861 | MOT863 | MOT1054 | MOT1318 | MOT1489 | MOT1340 | MOT1386 | MOT1490-1

Ref.	📦	EAN
11-322	1/4	5907558436235



FIAT Ducato, IVECO Daily 2002-2009
CITROEN Relay, Jumper III 2006-2009
PEUGEOT Boxer III 2006-2009



Silniki / Engines / Двигатели:
2.3 JTD - F1AE0481C, F1AE0481D, F1AE0481N,
3.0 JTD - F1CE0481D (2004-)
3.0HDI - F30DT
OEM: 99360614/(-).0191/2.B, 99360615/2.000.018.200/(-).191/2.A, 99360608/1.860.617.000

Ref.	📦	EAN
11-325	8/32	5907558436266



FIAT: Bravo/Brava, Barchetta, Coupe, Doblo Cargo, Idea, Marea/Weekend, Multipla, Siena, Palio/Weekend, Punto, Stilo
Silniki benzynowe / Gasoline engine / Бензиновый двигатель:
1.2; 1.4; 1.6; 1.8 16V
Bravo/Brava, Cargo, Doblo, Ducato, Marea/Weekend, Multipla, Palio/Weekend, Punto, Scudo, Stilo, Ulysse, Dukato, Croma itd



Silniki diesla / Diesel engine / Дизельный двигатель:
1.9D, 1.9TD, 1.9JTD, 2.4TD, 2.4JTD
OEM: 1860847000 | 1860875000 | 1870697000 | 1860895000 | 1895879000 | 1860898000 | 1860992000 | 1860771000 | 1860161000 | 1860874000 | 1860876000 | 1860845000 | 1860876000 | 1860965000 | 1860901000 | 1860905010 | 1860987000 | 1860985000

Ref.	📦	EAN
11-326	1/4	5907558436273



CITROEN: C4 Picasso/Grand Picasso (06-10), C5 II (04-08), C8 (05-10), Dispatch/Jumpy (07-11), Xsara 2.0 16v, C5 1.8/2.0/HPI, Xsara Picasso 1.8/2.0 16v (02-05)
PEUGEOT: 406 1.8 16v (00-04), 407 (06-10), 807 2.0 16v (02-05)



Kody silników / Engine codes / Коды двигателя:
1.8 16v: EW7A(6FY)
2.0 16v: EW10A(RFJ), EW10ABE4(RFH), EW10J4S(RFK)
OEM: 0189S1, 0189S2, 0132AB / 0194A/0178D, 0194B, 0188M, 0189B, 0188AH, 0189R, 70177R / 0153U, 0188J2, 0188J/J2, 0178E / 5711TE

Ref.	📦	EAN
11-321	1/4	5907558436228



FIAT: Panda, Idea, Doblo
OPEL: Agila, Corsa, Astra H, Tigra B, Meriva
ALFA ROMEO: 147, 156
OPEL: Astra, Vectra, Signum, Zafira



Silniki / Engines / Двигатели:
1,3 JTD MULTIJET (04-07)
1,3 CDTi (04-07)
1,9 / 2,4 JTD, 16V, 20V
1,9 JTD 16V / 2,4 JTD 20V
1,9 CDTi (04-06)
1,7D / 1,9 D FIAT / TD / JTD 2,4

Ref.	📦	EAN
11-323	1/4	5907558436242



ALFA ROMEO: Mito (10-15)
FIAT: 500 (07-15), 500C (07-15), Doblo/Cargo (05-10), Fiorino (09-15), Grande Punto (07-12), Idea (05-12), Linea (07-11), Panda/Panda Classic (09-13), Panda EVO2 (05-12), Punto EVO (09-12), Punto (12-15), Qubo (09-15), Seicento/600 (00-11)
FORD: Ka (09-15)
LANCIA: Musa (05-13), Ypsilon (06-15)



Kody silników / Engine codes / Коды двигателя:
Fiat: 1.1 8v; 187A1.000, 1.2/1.2 Dualogic; 169A4.000, 188A4.000 (EVO2 only), 199A4.000, 1.4/1.4 Bi-Fuel LPG/1.4 Natural Power CNG; 199A7.000, 350A1.000
Ford: 1.2 Duratec; 169A4.000(FPA)
Lancia: 1.2 8v; 188A4.000, 1.4/1.4 Bi-Fuel LPG; 350A1.000
OEM Ford: 303-1477 | 303-1478 | 303-1480 | 303-1479
OEM Fiat: 2000004200 | 2190754200 | 2000004300 | 2000004400 | 2190754400 | 2191964400 | 2000004500 | 2190754500 | 2191964500 | 1860987000

Ref.	📦	EAN
11-324	1/5	5907558436259



Zestaw blokad rozrządu

Timing tool set / Nockenwellen-Arretierwerkzeugsatz / Набор фиксаторов распредела для установки фаз ГРМ / Набор стопорів для розподілювальних валів / Vezérműtengely blokkoló készlet / Set de blocarea distribuției / Sada blokovací pro opravu rozvodů / Súprava blokad rozvodov / Set blokad gredi / Paskirstymo velenėlių fiksavimo komplektas / Sadales mehānismu fiksatoru komplekts / Jaotuse blokeerimise komplekt / Комплект блокировки на газораспределении / Set alata za blokiranje radilice / Pribor za blokadu razvodjenja / Σετ συγκράτησης κινωδοφόρων αξόνων / Kit de bloqueo de la correa de distribución / Attrezzi di blocco dell'albero a camme / Conjunto de bloqueios de engrenagem de distribuição / Ensemble de verrouillage de distribution / Set van distributievergrendeling



OPEL



OPEL:
Astra, Vectra B/C, Zafira, Signum,
Frontera
Silnik benzynowy/Gasoline engine:
2.2 16V



Kody silników / Engine codes / Коды двигателей:
ZZ2SE, ZZ2YH

Ref.	📦	EAN
11-331	1/5	5907558436297



OPEL



OPEL:
AGILA, ASTRA, CORSA, FRONTERA, OMEGA,
SINTRA, VECTRA, TIGRA, ZAFIRA, (SAAB,
RENAULT)



Silniki diesla / Diesel engine / Дизельный двигатель:
1.3CDTI 16V, 1.9CDTI, 2.0 Di, 2.2DTI
OEM: KM-952/09912-38310, KM-953/09919-58310, KM-954/09919-08310, KM-955/09919-58320, KM-6130

Ref.	📦	EAN
11-330	1/2	5907558436280



FORD



FORD:
Focus, C-Max, Mondeo (2003-2010)



Silniki benzynowe / Gasoline engine / Бензиновый двигатель: 1.6 16V
Kody silników / Engine codes / Коды двигателя: HXDA (2003-2007), HXJA, PNBA, RHBA,
Silniki diesla / Diesel engine / Дизельный двигатель: 2.0 TDCi
Kody silników / Engine codes / Коды двигателя: G6DA, G6DB, G6DC (2003-2007)
OEM Ford: 303-1097 | 303-1054 | 303-1059 | 303-1270 | 303-748 | 303-735 | 303-1277 | 21-259 | 21-263
OEM Peugeot: 0188X | 0187B | 0189B | 0188M | 0194B | 0132AJ1
OEM Citroen: 0188X | 0187B | 0189B | 0188M | 0194B | 0132AJ1
OEM Renault: MOT1430
OEM Volvo: 9997121 | 9997152 | 9997122

Ref.	📦	EAN
11-335	1/10	5907558436334

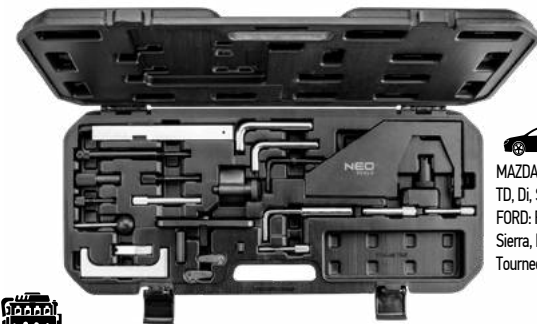

MAZDA
FORD



MAZDA: 1.4 1.8 2.0 2.4 2.5 TDCi,
TD, Di, SCI
FORD: Fiesta, Courier, Escort, Orion,
Sierra, Mondeo, Focus, Transit,
Tourneo, Fusion.



Silniki / Engines / Двигатели:
Diesel: 1.4 TDCi, 1.8 D/TD, 1.8 Di, 1.8 TDCi, 2.0TD/TDCi, 2.4 D, 2.5 Di/Turbo/Tci
Benzyna / Gasoline / Бензин: 1.8 Duratec - SCi
Kody silników / Engine codes / Коды двигателя:
C9DC, F9DA/B, C9DA/B, B9DA/B, B9PA, HCPA, FFDA, HCPB, P7PA, P9PA, R2PA, R3PA, RWPA, RFK, RFN, RKD, RTJ, RTK, 4EB, 4EC, 4ED, 4FA, 4FB, 4FC, 4FD, 4GA, 4GB, 4GC, 4GD, 4GE, 4HB, 4HC
OEM Mazda: 49 JE01 061
OEM Ford: 21-162 | 21-162B | 303-367 | 303-376 | 23-059 | 310-085 | 21-168 | 303-393 | 23-020 | 23-047 | 23-020 | 21-163 | 303-620 | 23-019 | 21-210 | 303-507 | 21-251 | 303-698 | 21-262 | 303-734 | 23-029 | 303-1061 | 23-058 | 310-084 | 21-105 | 21-262 | 303-734 | 21-168 | 303-393 | 21-263 | 303-735
OEM VAG: 3359 | T10008 | T10050 | 2065A

Ref.	📦	EAN
11-333	1/4	5907558436310



CHRYSLER
JEEP



Chrysler Voyager (2001-2008)
Chrysler Grand Voyager (2001-2008)
Jeep Cherokee (2001-2008)
LDV Maxus (2005-2008)



Kody silników / Engine codes / Коды двигателя:
R2516C, R2516L, R2816K, VM2516L
OEM: VM1052 | VM9660 | VM8873 | VM1080 | VM1068 | VM1089 | VM1053
Chrysler

Ref.	📦	EAN
11-332	1/10	5907558436303



FORD
ECOBOOST



FORD:
Galaxy, Mondeo, S-Max, Focus 2010-



Silniki benzynowe / Gasoline engine / Бензиновый двигатель:
2.0 SCTP EcoBoost/Ti-VCT
Kody silników / Engine codes / Коды двигателя:
TNWA / TNWB / TNBA / TPWA / MGDA / XQDA
OEM: 303-748 | 303-1504 | 303-1565 | 303-1521

Ref.	📦	EAN
11-336	1/5	5907558436341



Zestaw blokad rozrządu

Timing tool set / Nockenwellen-Arretierwerkzeugsatz / Набор фиксаторов распределения для установки фаз ГРМ / Набор стопорів для розподільвальних валів / Vezérműtengely blokkoló készlet / Set de blocarea distribuției / Sada blokovací pro opravu rozvodů / Súprava blokad rozvodov / Set blokad gredi / Paskirstymo velenėlių fiksuojimo komplektas / Sadales mehānismu fiksatoru komplekts / Jaotuse blokeerimise komplekt / Комплект блокировки на газораспределении / Set alata za blokiranje radilice / Pribor za blokadu razvođenja / Σετ συγκράτησης κινδωαφορών αξόνων / Kit de bloqueo de la correa de distribución / Attrezzi di blocco dell'albero a camme / Conjunto de bloqueos de engranagem de distribuição / Ensemble de verrouillage de distribution / Set van distributievergrendeling



FORD/CITROEN
FIAT/JAGUAR
LAND ROVER
LDV/PEUGEOT



Ford: Mondeo (00-07), Transit (00-14)
Citroen: Relay/Jumper III (06-13)
Fiat: Ducato (06-11) : Ducato (06-11)
Jaguar: X-Type (03-10)
Land Rover: Defender Td4 (06-11)
LDV: Convoy (02-06)
Peugeot: Boxer III (06-12)



Kody silników / Engine codes / Коды двигателя:

2.0D Di/TDci/TDC: ABFA, D3FA, F3FA, D5BA, D6BA, F1FA, FMBA, FMBB, HJBA, HJBB, HJBC, HJBE, N7BA, N7BB
2.2D TDCi/ECOnetic: BG, CYFA, CYFB, CYFC, DRFA, DRFB, DRFC, P8FA, P8FB, PGFA, PGFB, QJBA, QJBA (BG), QJBB, QJBC, QJBD, QVFA, QWFA, SRFA, SRFB, SRFC, SRFD, SRFE, UHFA
2.2D HDi/JTD:
P22DTE (4HM), P22DTE (4HU), P22DTE (4HV)
2.4D Di/TDCi: D0FA, D2FA, D2FB, D4FA, F4FA, FXFA, H9FA, H9FB, H9FD, JXFA, JXFC, PHFA, PHFC
2.4D TD/Tdi:
ZSD 424
2.4D Td4: 244DT
OEM: 303-679A/21-238, 303-1151, 303-698/21-251, 303-675/21-234

Ref.	☒	EAN
11-334	1/5	5907558436327



VOLVO



VOLVO:
Silniki benzynowe/gasoline engine: 4,5,6 cylinder
S80 (07-), V70 (08-), S80 (-06), XC90, V70 (00-08), V70 XC (01-)/XC70 (-07), S60, C30, C70 (06-), S40 (04-), V50, S40 (-04), V40, 850, C70 Coupe (-05), S70, V70 (-00), V70 XC (-00), 960, S90, V90



Kody silników / Engine codes / Коды двигателя:
B41XX, B42XX, B52XX, B62XX, B63XX, GB5252S

Ref.	☒	EAN
11-337	1/2	5907558436358

Ściągacz uniwersalny

Universal pulley puller / Universalabzieher / Универсальный съёмник / Знімач універсальний / Univerzální agylehűző / Extractor universal / Univerzální stahovák / Univerzálny stahovák / Univerzalni izvlekač / Univeršalus nutraukiklis / Univeršālais novilcejs / Univeršāalne tōmmits / Універсальен снабо за демонтаж / Univerzalni skidač / Univerzalna alatka za skidanje / Εξολκείας γενικής χρήσης / Extractor universal / Estrattore universale / Extrator universal / Extracteur de poulie universel / Univeršiele poelietrekker

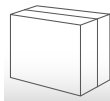

Ref.	☒	EAN
11-299	1/10	5907558436044

Nasadki do sondy lambda i wtryskiwaczy

Oxygen sensor and fuel injectors wrench set / Aufsätze für lambda-sonden und einspritzdüsen / Набор насадок для лямбда-зонда и форсунок / Насадки до лямбда-зонди і форсунок / Injektor és lambdaszonda szerelő készlet / Ajutaj pentru sonda lambda și injectoare / Кліче на лямбда сонду а встřиковací trysky / Nástavce na lambda sondu a za inžektory / Nasadni ključevi za sonda lambda in injektorji / Galvučių rinkinys lambda zondui ir purkštukams / Lambda zondes un sprauslu uzgaļi / Lambda sondi otsakud ja pihustid / Накрайниці за лямбда сонду и за інжектори / Nasadni ključevi za lambda sondu ubrizgivača / Nastavci za sondu lambda i brizgalice / Σετ καρδιάκια και ακροφύσια για αισθητήρα λямбда και εγχυτήρες / Casquillos para sonda lambda y para inyector / Bussole per sonda lambda e iniettori / Bocais para a sonda lambda e injetores / Douilles pour sondes lambda et injecteurs / Doppen voor lambdasonde en inspuiters



- 78 mm x 17, 19, 27, 28, 30 mm
- 80 mm x 27 mm
- 85 mm x 21 mm
- 90 mm x 22 mm
- 110 mm x 27 mm

Nasadka sześciokątna 1/2" do sondy lambda / 6 point socket 1/2" for oxygen sensors / Головка 6-гранная 1/2" для лямбда-зонда:

- 80 mm x 20 mm
- Nasadki odgięte do sondy lambda / Offset sockets for oxygen sensors / Головка для лямбда-зонда:
- 31 mm x 22 mm x 3/8"
- 50 mm x 22 mm x 1/2"

Nasadki dwunastokątna 1/2" do wtryskiwaczy / 12 point sockets 1/2" for diesel injectors / Головки 12-гранные для форсунок:

- 110 mm x 22 mm
- 150 mm x 22 mm

Ref.	☒	EAN
11-880	0/5	5907558436877



Nasadki dwunastokątna 1/2" do sondy lambda / 12 point sockets 1/2" for oxygen sensors / Головки 12-гранные для лямбда-зонда:

- 78 mm x 22, 28 mm
- 80 mm x 27 mm
- Nasadka sześciokątna 1/2" do sondy lambda / 6 point socket 1/2" for oxygen sensors / Головка 6-гранная 1/2" для лямбда-зонда:
- 90 mm x 29 mm

Nasadki sześciokątna 3/8" do sondy lambda / 6 point sockets 3/8" for oxygen sensors / Головка 6-гранная 3/8" для лямбда-зонда:

- 74 mm x 27 mm
- 80 mm x 22 mm
- 90 mm x 22 mm

Odgięte nasadki do sondy lambda / Offset sockets for oxygen sensors / Головка для лямбда-зонда:

- 31 mm x 22 mm x 3/8"
- 50 mm x 22 mm x 1/2"
- Nasadka dwunastokątna 1/2" do wtryskiwaczy / 12 point socket 1/2" for diesel injectors / Головка 12-гранная 1/2" для форсунок:
- 108 mm x 22 mm

Ref.	☒	EAN
11-882	0/5	5907558436891

Klucze nasadowe do sondy lambda

Oxygen sensor socket wrench / Aufsatzschlüssel für lambda-sonde / Торцевые головки для лямбда-зонда / Ключи торцеві до лямбда-зонди / Lambdaszonda szerelő készlet / Chei tubulare pentru sonda lambda / Nástrčné klíče pro sondy lambda / Nástavcové klíče na lambda sondu / Nasadni ključevi za sonda lambda / Galvutės lambda zondui / Mucipatslēgas lambda zondei / Lambda sondi vōti / Ключови накрайниці за лямбда сонду / Nasadni ključevi za lambda sondu / Ključ natikač za sonda lambda / Καρδιάκια για αισθητήρα λямбда / Llave de vaso para sonda lambda / Set di bussola per sonda Lamda / Chaves articuladas para a sonda lambda / Clé à sonde lambda / Dopsleutels voor lambdasonde



- 1/2" x 29 x 90 mm (wycięcie 8 mm)
- 1/2" x 27 x 80 mm
- 3/8" x 7/8" x 90 mm (wycięcie 20 mm)
- 3/8" x 1-1/16" x 74 mm
- 3/8" x 7/8" x 80 mm
- 1/2" x 22 x 50 mm
- 3/8" x 22 x 31 mm

Ref.	☒	EAN
11-881	0/10	5907558436884



Klucze nasadowe do sondy lambda

Oxygen sensor socket wrench / Aufsatzschlüssel für lambda-sonde / Торцевые головки для лямбда-зонда / Ключи торцевые до лямбда-зонды / Lambdasonda kulcs készlet / Cheie tubulare pentru sonda lambda / Nástrčné klíče pro sondy lambda / Nástavcové klíče na lambda sondu / Nasadni ključji za sondo lambda / Galvutės liambda zondui / Mucipatslēgas lambda zondei / Lambda sondi vōti / Ключови накрайници за лямбда сонда / Nasadni ključevi za lambda sondu / Ključ natikača za sonde lambda / Καρυδάκια για αισθητήρα λάμδα / Llave de vaso para sonda lambda / Set di bussole per sonda Lambda / Chaves articuladas para a sonda lambda / Clé à sonde lambda / Dopsleutels voor lambdasonde

Otkienka w nasadkach pozwalają na montaż bez demontażu przewodów

Nasadki pasują do popularnych aut osobowych poruszających się po europejskich drogach

Open-sided for lambda probe fitting without the removal of cables

The sockets fit popular European cars

Дірочки в голівках дозволяють проводити монтаж без демонтажу проводів

Голівки підійдуть популярним легковим автомобілям на європейських дорогах



Klucz do sondy lambda

Oxygen sensor socket wrench / Schlüssel für lambda-sonde / Ключ для лямбда-зонда / Ключ до лямбда-зонды / Lambdasonda kulcs, rövid / Cheie pentru sonda lambda / Klíč na lambda sondy / Ključ na lambda sondu / Ključ za sonda lambda / Raktas liambda zondui / Lambda zondes atslēga / Lambda sondi vōti / Ключ за лямбда сонда / Ključ za lambda sondu / Ključ za sonda lambda / Кλειδί αισθητήρα λάμδα / Llave para sonda lambda / Set di bussole per sonda Lambda / Chave para a sonda lambda / Clé à sonde lambda / Sleutel voor lambdasonde

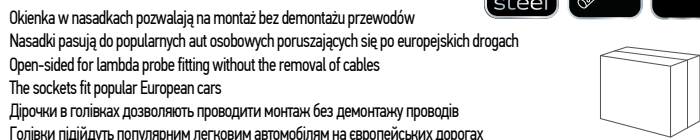

Nasadka końcowej sondy lambda (gorącej) / The socket for end lambda probes (hot) / Голівка для кінцевих лямбда-зондів (гаряча) 1/2", 22 mm x 50 mm

Nasadka czujnika podciśnienia i sondy lambda (do sond nisko osadzonych) / The socket for end lambda probes (hot) / Голівка вакуумного датчика і лямбда-зондів (для низько посаджених зондів) 3/8", 22 mm x 30 mm

Nasadka czujnika podciśnienia i sondy lambda / The socket for vacuum sensor and lambda probe / Голівка вакуумного датчика і лямбда-зондів 3/8", 22 mm x 80mm

Ref.	⊠	EAN
11-203	0/20	5907558416763



Nasadka do długich sond lambda i tam gdzie złącze przewodów nie pozwala na zastosowanie typowej nasadki do sond ze szczeliną

The socket is suitable for long lambda probes and wherever cable connectors do not allow for using typical probe sockets with a gap

Голівка для довгих лямбда-зондів і там, де кабельний роз'єм не дозволяє використовувати типову голівку для лямбда-зондів з зазором

Ref.	W [mm]	⊠	EAN
11-204	22	10/100	5907558416749



Nasadka do krótkich sond lambda

The socket is suitable for short lambda probes

Голівка для коротких лямбда-зондів



Ref.	W [mm]	⊠	EAN
11-205	22	10/50	5907558416756

Ściągacze do wtrysków z młotkiem bezwładnościowym

Fuel injector service set / Abzieher für Einspritzungen mit Trägheitshammer / Комплект для снятия дизельных форсунок с обратными молотками / Комплект знімачів форсунок зі зворотним молотками / Befestigungszöfje kihúzós készlet csúszó kalapáccsal / Instalații de decapare pentru injectări cu ciocan inertial / Sada na vstřikovače s reverzním kladivem / Stahováky vstrekoavačov so zotrvačným kladivom / Izvlekači za injektorje z inercijskim kladivom / Dizelinių purkštukų nuėmimo komplektas su atbuliniu plaktuku / Dizela sprauslu porėtėju komplektas ar inercijos amru / Kütusepihusti tõmmitsad, inertshaariga / Инструмент сноба обратен чука за вадене на дизелу / Skidači za ubrizgivače s inercijskim čekićem / Komplet alatki za skidanje mlaznica sa inercijalnim čekićem / Σετ εξαγωγής ακροφυσίων εγχυτήρα ντιζελ με αφυρία ολίσθησης, κεφαλές / Extractores para inyección con martillo de inercia / Estrattori per iniettori con martello inerziale / Fresas para limpeza de encaixes de injetores / Kit extracteur injection diesel avec marteau coulissant / Injectietrekkers met glijhamer

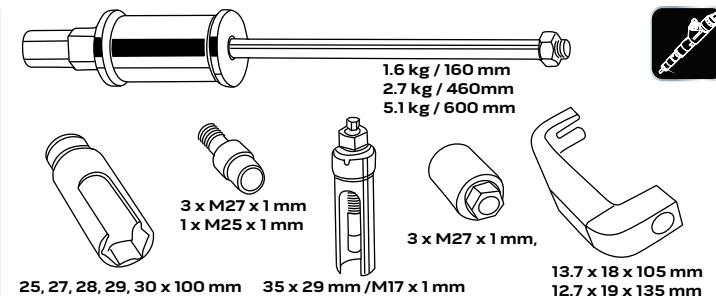
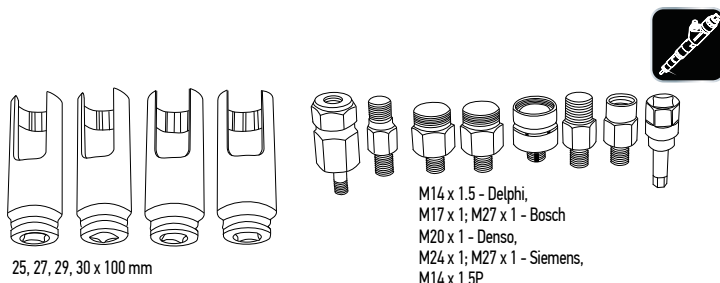

Ref.	⊠	EAN
11-883	1/2	5907558435405



Ref.	⊠	EAN
11-884	1/1	5907558435412



Frezy do czyszczenia gniazd wtryskiwaczy

Diesel injector seat cleaning / Fräsen zur Reinigung von Einspritzbuchsen / Набор для чистки посадочных мест дизельных форсунок / Набор для чищення посадкових місць дизельних форсунок / Injektor fészek maró és tisztító készlet / Freze pentru curățarea prizelor injectoarelor / Frézy na čištění sedel vstříkovačů / Frézy na čistenie zásuviek vstrekovačov / Orodje za čiščenje ležišč injektorjev / Dyzelinių purkštukų lizdų valymo įrankių rinkinys / Dizela sprauslu ligzdu tīrītāji / Pihustipesade puhastamise freesid / Фрезы за почищення на лезлото на инжектору / Set za čiščenje priključka ubrizgivača / Pribor za čiščenje utičnica ubrizgivača / Σετ καθαρισμού υποδοχών ακροφυσίων εγχυτήρα ντίζελ / Fresas para la limpieza de las tomas de los inyectoros / Frese per la pulizia delle sedi degli iniettori / Fresas para limpeza de encaixes de injetores / Kit de nettoyage pour sièges d'injecteurs / Freestukken voor reiniging van injectie nesten

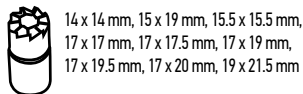

14 x 14 mm, 15 x 19 mm, 15.5 x 15.5 mm, 17 x 17 mm, 17 x 17.5 mm, 17 x 19 mm, 17 x 19.5 mm, 17 x 20 mm, 19 x 21.5 mm



15.5 x 15.5 mm, 17 x 17 mm, 17 x 21 mm, 17.5 x 20.5 mm



Ref.	☒	EAN
11-885	1/5	5907558435429

Zestaw do centrowania tarcz sprzęgła

Clutch center set / Zentriersatz für Kupplungsscheiben / Универсальный набор для центровки дисков сцепления / Набор універсальний для центрування дисків зчеплення / Kuplungtárcsa központosító készlet / Trusa de centrare a discurilor de ambreiaj / Sada pro centrování spojkových kotoučů / Centrovacia súprava kotúčov spojky / Kľuč za centriranje plošč sklopke / Sankabos diskų centravimo rinkinys / Sajūga disku centrēšanas instrumentu universālais komplekts / Siduriketaste tsentreerimise komplekt / Комплект за центровка на съединителу / Set za centriranje ploča spojke / Pribor za centriranje diskova kvačila / Σετ κεντραρίσματος δίσκων συμπλέκτη / Kit de centrado de la placa de embrague / Kit per il centraggio del disco frizione / Kit de centrage de discos de embragem / Kit de centreage pour disques d'embrayage



11, 12, 15, 17, 19, 20, 21, 25 mm



Ref.	☒	EAN
11-170	1/10	5907558437348



Frez do gniazd zaworowych diesel. Zawartość: frez 15 mm płaski frez uniwersalny, 17 mm frez płaski dla wtryskiwaczy, Delphi/Bosch (BMW/PSA/Renault/Ford), 19 mm Frez płaski dla wtryskiwaczy Bosch (Mercedes CRD), 19 mm Frez kątowy do wtryskiwaczy Fiat/Iveco, Trzpień pilotujący 19 mm HEX

Diesel injector seat cutter set 4 pcs. Edge trimming cutter 15 mm flat, universal, 17 mm flat for Delphi/Bosh injectors (BMW/PSA/RENAULT/FORD), 19 mm flat for Bosh injectors (Mercedes CRD), 19 mm angle edge trimming cutter for FIAT/IVECO, Pilot mandrel 19 mm HEX

Фреза для чистки седел дизельных форсунок. В комплекте: плоская фреза 15 мм - универсальное применение, 17 мм плоская фреза для Delphi/Bosch (BMW/PSA/Renault/Ford), 19 мм плоская фреза для Bosch (Mercedes CRD), 19 мм угловая фреза для Fiat/Iveco, держатель-направляющая 19 мм HEX



Ref.	☒	EAN
11-218	0/20	5907558420401

Ściągacz do sprzęgieł skrzyń DCT

DCT Clutch Tool / Abzieher für Doppelkupplungsgetriebe / Съемник для сцепления в коробках передач DCT / Знімач до зчеплення у коробках передач DCT / DCT váltó kuplung leszedő szerszám / Strângere pentru ambreiajele DCT / Přípravek na montáž a demontáž spojky k DCT převodovce / Stáhovák pre spojky DCT / Orodje za skidanje spojke DCT / Sankabos diskų nuėmimo įrankis DCT / Ford/Volvo DCT átrumkárbu sajūga noėmėjs / DCT-kasti sidurite tōmmitis / Специализиран инструмент за монтаж/демонтаж на DCT съединителу / Alat za skidanje spojki kovčega DCT / Alatka za izvlačenje kutije kvačila DTC / Εργαλείο εξιμωταρίσματος συμπλέκτη στο κιβώτιο ταχυτήτων / Tirador para embragues DCT / Estrattore frizione per cambio DCT - Ford/Volvo / Extrator de embraiagens das caixas DCT / DCT outil d'embrayage / Kraag voor DCT koppeling



Volvo: C30, C70 (06>), S40 (04>), S60 (11>), S80(07>), S80L, V40 (13>), V40 Cross Country, V50, V60, V70(08>), XC60 Ford: Focus(04>), C-Max, S-Max, Galaxy, Mondeo (07>), Kuga (13>), zamiennik / replacement / заміна OEM: Volvo 9997435, Ford 308-763



Ref.	☒	EAN
11-171	1/4	5907558437379



Szczypce do opasek

Clamp pliers / Zange für Kraftstoffleitungen / Щипцы для хомутов / Щипци для шлангов / Bilincsfogó / Clește / Kleště na spony / Kliešte na hadicové spony / Klešče za vzmetne objemke / Replės žarnelių žiedų užspaudimui / Savilceju knaibles / Kaablisidemet tangid / Щипци за проводници на гориво / Kliešta za stiskanje / Klešta za žicu / Λαβίδες στεφανιών στερέωσης / Alicates para bridas / Pinza per morsetti in gomma / Pinças para abraçadeiras / Pince de serrage

Do opasek sprężynujących na przewodach olejowych i wodnych etc.
Do pracy w miejscach trudnodostępnych
Długość giętkiej części: 630 mm, długość części z rękojścią: 210 mm
Zasięg ścisku: 0 – 45 mm

For spring clips on oil and water hoses
For difficult to reach places
Flexible section length: 630 mm, handle section length: 210 mm
Clamping range: 0 – 45 mm

Для пружинних хомутів паливних, масляних і водяних шлангів і т.д.
Для роботи у важкодоступних місцях
Довжина гнучкої деталі: 630 мм, довжина деталі з рукою: 210 мм
Діапазон затиску: 0 – 45 мм



Ref.	W [mm]	☒	EAN
11-221	840	6/36	5907558416602

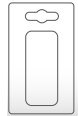

Ref.	☒	EAN
11-222	0/54	5907558418545



Ref.	☒	EAN
11-223	6/48	5907558418552

Szczypce zaciskowe z tworzywa

Flexible line clamp / Gripzange aus Kunststoff / Набор зажимов с фиксатором / Кліщі дзвильні пластикової / Őnzáró fogókészlet műanyag / Clește de strângere din plastic / Plastové svěrací kleště / Zvieracie plastové kliešte / Plastične klešče za prešcip cevi / Replės stabdžių šlangelėms užspausti / Plastmasas saspiešanas knaibles / Plastist lukustustangid / Стягаючи клеци от пластмаса / Stezna kliešta od umjetnog materijala / Plastična klešta / Σετ σφρυκτήρες με μηχανισμό ασφαλίσης / Tenazas abrazaderas de plástico / Pinza occlusione tubo in plastica / Pinças de plástico / Pince de serrage en plastique / Krimptang van kunststof



Ref.	☒	EAN
11-224	0/48	5907558418699



Ref.	☒	EAN
11-226	6/60	5907558420197



Zestaw mini szczypiec do pierścieni osadzczych

Mini pliers set for circlips / Mini-Zangenset für Stellringe / Набор щипцов для стопорных колец, "mini" / Набор минищипцов до стопорных колець / Mini pliers set for circlips / Garnitura de mini clesti pentru inele de strangere / Sada precizních kleští na pojistné kroužky / Súprava mini klieští na poistné kružky / Set mini klešč za objemke / Mini replij komplektas, fiksavimo žiedams / Sprostgredzenu knaiblu komplekts, mini / Lukustusrõngaste minitangide komplekt / Комплект мини щипцов за стопорни пръстени / Set mini seger kliešta za stiskanje i širenje / Komplet mini kliešta za taložne prstene / Σετ μικρές λαβίδες για δακτύλια ασφαλείας / Juego de mini alicates para anillos de retención / Kit mini pinze per anelli d'arresto / Pinças para anéis / Jeu de mini-pinces pour colliers de fixation / Set van mini tangen voor dopringen



Ref.	☒	EAN
11-227	24/48	5907558420395



Zaciskacz do pierścieni

Piston ring compressor / Ringklemme / Оправка поршневых колец / Затискич до кілець / Dugattyúgyűrű szorító szalag / Strångåtor de inele / Svärka na kroužky / Pás na stáňovanie piestnych krúžkov / Obročni prižemnik / Žiedu suspaudejās / Gredzenu saspiedējs / Vārusulgur / Стяга за пръстени / Stezaljka za prstenje / Stezač za prsten / Συμπιεστής δακτυλίων εμφόλου / Compresor para anillos / Morsetto per anelli / Fixador de anéis / Colier de serrage / Ringklem

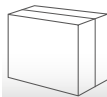

Ref.	Ra [mm]	☒	EAN
11-250	50 - 125	0/60	5907558418330

Klucz do demontażu napinaczy z wymiennymi końcówkami

Tensioner pulley / Schlüssel zum Abbau von Spannern mit auswechselbaren Spitzen / Ключ для снятия переднатяжителей со сменными наконечниками / Ключ для зняття переднатягачів зі змінними наконечниками / Feszítőgörgő kulcs cserélhető fejjel / Cheia pentru demontarea întinzătoarelor cu capete interschimbabile / Klíč na demontáž napínací kladky s výměnitelnými koncovkami / Ključ na odstránovanie napínačov s výmeniteľnými hrotmi / Ključ za odstranitev zategovalnikov z izmenljivimi konicami / Raktas įtempiklį nuėmimui, su keičiamais antgaliais / Priekšspriegotāja demontāžas atslēga ar maiņas uzgaļiem / Pingutite eemaldamise võti, vahetatavate otsakutega / Ключ за демонтиране на обтяжни роли със сменяеми накрайници / Ključ za demontažu zatezača sa izmenljivimi nastavcima / Ključ za demontiranje zatezača sa promenljivim krajevima / Κλειδί αφάιρεσης προεντατήρων με ανταλλακτικές μύτες / Llave para quitar los tensores con puntas intercambiables / Chiave per smontaggio dei tenditori con punte intercambiabili / Chave para desmontar tensores com pontas substituíveis / Clé de démontage des détracteurs avec embouts interchangeables / Sleutel voor demontage van spanners met eindstukken

12, 13, 14, 15, 16, 17, 18, 19 mm

E10, E12, E14, E16, E18



Ref.	☒	EAN
11-169	0/10	5907558437331

Klucz do napinania pasków klinowych

Transmission belt tensioning wrench / Schlüssel zum Spannen von V-Spanngurten / Ключ для затягивания клиновых ремней / Ключ для затягування клинових пасів / Ékszjij feszítő kulcs / Cheie pentru strângerea curelei trapezoidale / Klíč k napínání řemenice / Klúč na uťahovanie klinových remeňov / Ključ za naprejanje klinastega jermena / Pleištniņū diržu užveržimo raktas / Transmisijas siksnas pievilksanas atslēga / Kilirihmade pingutamise võti / Инструмент за натягане на клинов ремък / Ključ za naprežanje remena / Ključ za zatezanje klinastih remenova / Κλειδί τάνυσης σφρνοειδών ιμάντων / Llave para apretar las correas / Chiave per il tensionamento di cinghie dentate / Chave para tensionar correias / Clé pour tendre des courroies / Spanner voor V-snaar



40-200 mm



Ref.	☒	EAN
11-168	1/6	5907558437324

Zestaw do alternatora

Combined sockets for alternator / Lichtmaschinen-Schlüsselsatz / Набор для альтернатора / Набор до генератора змінного струму / Készlet generátor szereléshez / Set de alternator / Sada na alternátory / Súprava pre alternátor / Set za alternator / Rinkiny's kintamosios srovės generatoriui / Mainstrāvas ģeneratora instrumentu komplekts / Generaatori padrunvõtmete komplekt / Комплект за алтернатора / Garnitura za alternator / Garnitura za alternator / Σετ για εναλλακτήρα / Juego para alternador / Kit per montaggio e smontaggio alternatori / Jogo de acessórios para alternador / Kit d'alternateur / Set voor wisselstroomgenerator

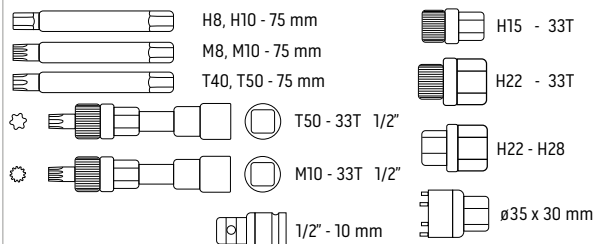

Ref.	☒	EAN
11-167	1/10	5907558437317

Zestaw do układów ciśnienia/podciśnienia

Tester for vacuum and pressure systems / Satz für Druck-/Vakuumsysteme / Набор для напорных / вакуумных систем / Набор для напірних/вакуумних систем / Vákuum és nyomás tesztelő / Set pentru sisteme de presiune / vid / Tester pro tlakové/podtlakové systémy / Súprava pre tlakové / podtlakové systémy / Set za vakuumske in tlačne sisteme / Rinkiny's slėgio / vakuumo sistemoms / Spiediena / vakuuma sistēmu instrumentu komplekts / Rõhu-/vaakumsüsteemide komplekt / Помпа за тестване на вакуум и налягане / Set za sustave tlaka/podtlaka / Pribor za sistem pritiska/vakuuma / Σετ για συστήματα κενού αέρος/παροχής υπό πίεση / Probador de sistemas de presión / vacío / Kit per impianti a pressione/in depressione / Kit para sistemas de pressão/subpressão / Testeur de pression / compression / Meter voor druk/onderdruk systemen

-1÷3 BAR



Ref.	☒	EAN
11-267	1/10	5907558436013



Zestaw do diagnostyki systemów Common Rail

Common Rail diagnostic set / Diagnossatz für Common-Rail-Systeme / Набор для диагностики систем Common Rail / Набор для диагностики систем комон-рэйл / Common rail rendszer diagnosztikai készlet / Trusă pentru diagnosticarea sistemelor Common Rail / Sada pro diagnostiku systémů Common Rail / Sada pre diagnostiku systémov Common Rail / Set za diagnostiko sistemov Common Rail / Diagnostikos rinkinys, skirtas sistemai Common Rail / Common Rail sistėmu diagnosticėšanas komplekts / Common Rail sūsteemide diagnostikakomplekt / Комплект за диагностика на систему Common Rail / Set za dijagnostiku sustava Common Rail / Pribor za dijagnostiku sistema Common Rail / Διαγνωστικό σετ για συστήματα Common Rail / Set para diagnóstico de sistemas Common Rail / Kit diagnostico per sistemi Common Rail / Kit de diagnóstico de sistemas Common Rail / Kit de diagnostic pour systèmes Common Rail / Common Rail diagnostische set



BOSCH
SIEMENS
DENSO
DELPHI



Ref.	📦	EAN
11-263	1/5	5907558435979

Zestaw do testowania systemów wtryskowych

Fuel injection injector pressure test set / Testsatz für Einspritzsysteme / Набор для проверки форсунок впрыска топлива / Набор для перевірки форсунок вприскування палива / Befuelskendező rendszer tesztelő készlet / Set pentru testarea sistemelor de injecție / Sada pro testování vstřikovacích systémů / Súprava na testovanie vstrekovacích systémov / Set za testiranje injektorskih sistemov / Įpurškimo sistemų testavimo rinkinys / Degvielas iesmidzināšanas sprauslas pārbaudes instrumentu komplekts / Sissepritsesüsteemide testimise komplekt / Комплект за диагностика на инжекционни системи / Set za ispitivanje sustava ubrizgivanja / Sistem za testiranje sistema za ubrizgavanje / Σετ ελέγχου ακροφυσίου έγχυσης καυσίμου / Kit para pruebas de sistemas de inyección / Kit per il test di sistemi di iniezione / Kit de testagem de sistemas de injeção / Kit d'essai pour systèmes à injection / Brandstofinjectie test set



0-10
BAR

Ref.	📦	EAN
11-264	1/5	5907558435986

Miernik ciśnienia sprężania

Compression tester / Verdichtungsdruckmesser / Компрессометр бензиновый / Компресометр / Kompresszió mérő készlet / Aparat de măsurat compresia / Měřicí přístroj kompresního tlaku / Merač kompresného tlaku. / Merilec pritiska adapter / Kompresijos matuoklis / Kompresijos manometrs / Manometer adapterite komplekt / Компресометр / Mjerač pritiska / Merač pritiska sabijanja / Συμμετρητρο βενζίνης / Medidor de aire comprimido / Misuratore della compressione / Medidor de pressão de compressão / Compressiometre compression / Meter van persdruk

70
BAR x16
DIESEL



Miernik kompresji do pomiarów ciśnienia sprężania w cylindrach silników wysokopreżnych (diesla)
Zestaw zawiera różne adaptery pasujące do większości silników aut osobowych i dostawczych
Maksymalny zakres pomiaru – 70 barów

Pressure gauge for measuring compression pressure in diesel engine cylinders
The set includes various adapters suited for a majority of passenger and delivery vehicle engines
The maximum measurement range – 70 bars

Компресометр для вимірювання тиску в дизельних двигунах
Включає адаптери, які підходять для більшості двигунів легкових і вантажних автомобілів і вантажніків
Діапазон вимірювального тиску – до 70 бар

Ref.	📦	EAN
11-262	0/6	5907558416732

21
BAR



Miernik kompresji do pomiarów ciśnienia sprężania w cylindrach silników spalinyowych benzynowych
Zestaw zawiera adapter pasujący do większości silników aut osobowych i dostawczych
Maksymalny zakres pomiaru – 21 barów

Compression pressure gauge for measuring compression pressure in petrol combustion engine cylinders
The set includes an adapter suited for a majority of passenger and delivery vehicles
The maximum measurement range is – 21 bars

Компресометр для вимірювання тиску в бензинових двигунах
Включає адаптер, який підходить для більшості двигунів легкових і вантажних автомобілів
Діапазон вимірювального тиску – до 21 бар

Ref.	📦	EAN
11-261	0/20	5907558416725



Tester ciśnienia turbosprężarki

Turbo pressure gauge / Druckprüfgerät für Turbolader / Тестер турбо давления / Тестер тиску у турбокомпресори / Turbófeltöltő nyomás tesztelő / Tester de presiune turbocompresor / Manometr pro kontrolu tlaku turba / Tester tlaku turbodúchadla / Preskuševalnik tlaka turbo kompresorja / Turbokompresorių testavimo rinkinys / Turbo spiediēna mērtājs / Turbolaaduri rõhu tester / Тестер за налягане на турбокомпресор / Tester pritiska u turbokompresoru / Tester za pritisak turbokompresora / Ελεγκτής πίεσης turbo / Probador de presión para turbocompresor / Tester di pressione per turbocompressori / Aparelho de teste de pressão de turbocompressor / Testeur de pression d'huile turbocompresseur / Turbokompresor druk meter



-1÷3
BAR



Ref.	☒	EAN
11-265	1/10	5907558435993

Nasadka do świecec

Spark plug socket / Aufsatz für Zündkerzen / Головка сменная свечная / Ключ свечной / Gyertyakulcs / Cheie tubulara pentru bujii / Nástavec na svíčky / Nástavec na svečky / Nasadni ključ za svečke / Galvutē žvakēms / Sveču atslēga / Kūinlapadrin / Наставка за свещи / Карпача за свјеџице / Nasadka za sveče / Καρπούκι για μπουζί / Vaso para bujía / Chiave per candele / Bocai p. velas / Douille à bougie / Kaarsendop

CrV
steel

1/2"



Ref.	W [mm]	L [mm]	☒	EAN
08-090	16	65	24/144	5907558406092
08-091	21	68	24/96	5907558406252

Klucz do świecec

Spark plug wrench / Zündkerzenschlüssel / Ключ свечной / Ключ для свечок / Gyújtógyertyakulcs / Cheie lumânare / Klíč na svíčky / Klíč sviečkový / Ključ za vžigalno svečko / Raktas degimo žvakēms / Svečatslēga / Süüteküünla võti / Ключ / Ključ / Ключ / Клеиди για μπουζί / Llave para bujía / Bussole poligonala / Chave p. velas / Clef à bougie / Kaarssteutel



3/8"



Ref.	W [mm]	L [mm]	☒	EAN
11-152	14	90	50/100	5907558417166
11-153	16	90	50/100	5907558417173

Tester ciśnienia oleju

Engine oil pressure tester / Druckprüfgerät für Öldruck / Тестер давления масла / Тестер тиску оливи / Olajnyomás tesztelő / Tester de presiune ulei / Tester tlaku oleje / Tester tlaku oleja / Preskuševalnik tlaka olja / Tepalo slęgio matuoklis / Είλας spiediēna mērtājs / Ölirõhu tester / Тестер за налягането на маслото / Tester pritiska ulja / Tester za pritisak ulja / Ελεγκτής πίεσης λαδιού / Probador de presión del aceite / Tester di pressione dell'olio / Aparelho de teste de pressão de óleo / Testeur de pression d'huile / Motorolie druk meter

0-10
BAR



Ref.	☒	EAN
11-266	1/2	5907558436006

Szczypce do ściągania przewodów zapłonowych

Spark plug wire boot pliers / Zange zum Abziehen von Zündkabeln / Плоскогубцы для снятия проводов зажигания / Пласкогубци для знімання дротів запалювання / Gyújtókábel lehúzó fogó / Clește pentru scoaterea cablurilor de aprindere / Kleště na kabely zapalovacích svíček / Klešte na demontáž zapalovacích vodičov / Klešče za vtiče vžigalnih svečk / Replijų rinkinys, užvedimo laidų nužievimimui / Platknaiables aizdedzes vadu noņemšanai / Süütejuhtmete näpitsad / Клещи за кабели на свещи / Klješta za skidanje žica za paljenja / Kješta za skidanje kablova svečica / Πένσα εξαγωγής υποζκαλωδίων / Alicates para quitar los cables de arranque / Pinze per lo scollamento dei cavi d'accensione / Alicates para extração de cabos de ignição / Pincas pour enlever les câbles batterie / Tangen voor bougie leidingen



Ref.	☒	EAN
11-165	5/20	5907558437294



Szczelinomierz

Feeler gauge / Schiebelehre / Щлн / Щлн / Hézagmérő készlet / Calibru măsurare grosime / Spároměr / Listkové mierky / Kontrolni lističi / Ertmių matavimo prietaisai / Spraugmērs / Mõõtesond / Лыфтомер / Kontrolni lističi / Kontrolni lističi / Διακονόμετρο / Calibre de espesores / Calibra a spessori / Medidor de folgas / Jauge d'épaisseur / Voelmaat

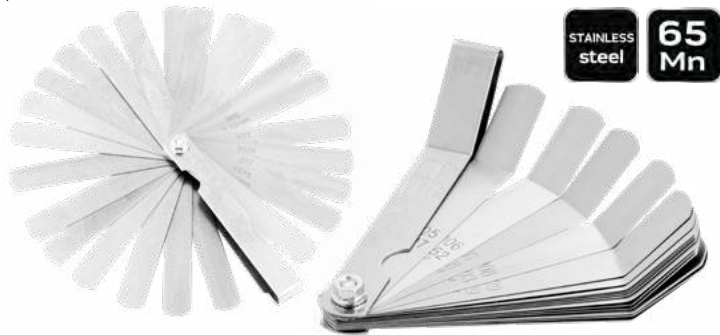

STAINLESS steel
65 Mn

11-192



Ref.	Ra [mm]	N	☒	EAN
11-190	0.04 - 0.63	26	20/120	5907558452433
11-191	0.05 - 1.0	20	20/120	5907558452440
11-192	0.127 - 0.508	16	20/120	5907558452457

Ściągacz do ramion wycieraczek

Wiper arm puller / Abzieher für Scheibenwischer / Съёмник рычагов стеклоочистителя / Знімач важелів склоочисників / Ablaktöröl kar lehúzó / Dispozitiv de scos de brate de stergător de parbriz / Stahovák na ramínka stěračů / Sťahovač na demontáž ramienok stieračov / Snemalec za brisalce / Valytuvų kotų nuėmėklis / Stikla tīrītāju plecu novlēcējs / Kojamehe hoobade tõmmits / Скоба за рамо на чистачката / Alat za skidanje brizgaljki / Alat za skidanje ramena brisača / Εξολκείας μοχλών υαλοκαθαριστήρα / Extractor de brazos de limpiaparabrisas / estrattore per braccio del tergicristallo / Extrator de limpa para-brisas / Extracteur de bras d'essuie-glaces / Trekker voor ruitenwisserarmen

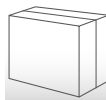

Ref.	☒	EAN
11-827	0/120	5907558420067

Zestaw do demontażu poduszek powietrznych

Airbag removal tool set / Abbausatz für Luftkissen / Набор для замены подушки безопасности / Набор для заміни подушок безпеки / Légzsák kiszerező készlet / Set pentru scoaterea airbag-urilor / Sada na demontáž airbagů / Súprava na demontáž airbagov / Set za odstranitev zračnih blazin / Oro pagalvių išmontavimo rinkinys / Drošības spilvena noņemšanas instrumentu komplekts / Ūhkratjude eemaldamise komplekt / Комплект за демонтаж на въздушни възглавници / Set za skidanje zračnih jastuka / Pribor za demontiranje vazdušnih jastuka / Σετ αντικατάστασης αερόσακου / Kit de desmontaje de airbags / Kit per lo smontaggio di airbag / Kit de ferramentas de desmontagem de airbags / Kit de démontage des airbags / Set voor demontage van airbags

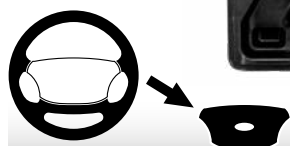

Ref.	☒	EAN
11-817	1/10	5907558436785

Zestaw do demontażu szyb

Car windows disassembling set / Abbausatz für Scheiben / Набор для демонтажа лобовых стекол / Набор для демонтажу вітрового скла / Szélvédő kiszerező készlet / Set pentru demontarea geamurilor / Souprava pro demontáž skel / Súprava na demontáž okien / Set za odstranitev stekel / Automobilių stiklų išmontavimo rinkinys / Autostiklu demontāžas komplekts / Tuuleklaasi eemaldamise komplekt / Комплект за демонтаж на автостъкла / Set za demontažu stakla / Pribor za demontiranje stakla / Σετ εξαγωγής παρμπρίζ / Kit de desmontaje de ventanillas / Kit per lo smontaggio di cristalli / Kit de ferramentas de desmontagem de vidros / Kit de démontage de vitres



Ref.	☒	EAN
11-819	1/10	5907558436792

Zestaw nasadek specjalnych

Socket set / Aufsatzset / Набор головок торцевых / Набор насадок торцевых / Törtcsavarokihajító készlet / Set duze / Sada násadek / Súprava nástr. klúčov / Garnitura nasadnih ključev / Antgalių rinkinys / Muciņu komplekts / Padrunikomplekt / Тедор компл / Šesterokutne kapice / Gedora set / Συλλογή καρδουακιών / Llaves de vaso / Set di boccole / Kit de bicos / Jeu de douilles / Set van doppen

x16 1/2"

8, 10, 11, 12, 13, 14, 15, 16, 17, 19, 21, 22, 24, 27 mm

2 wybijaki do usuwania śrub z nasadek

2 x punches

2 выколотки для снятия винтов с головок

Można stosować z kluczami udarowymi

Suitable for impact wrenches

Можно использовать с ударными гайковертами

Wewnętrzna spirala powoduje samoczynne zaciskanie się na uszkodzonej śrubie/nakrętkę umożliwiając bezpieczne odkręcenie

The innovative spiral profile digs itself into the head of a damaged screw/nut and thereby allows to loosen it securely
Внутренняя спираль вызывает автоматическое зажатие поврежденного болта/гайки, обеспечивая безопасное откручивание



Ref.	☒	EAN
11-920	0/10	5907558436914



Zestaw nasadek specjalnych

Socket set / Aufsatzset / Набор головок торцевых / Набор насадок торцевых / Törtcsavarkihajító készlet / Set duze / Sada násadek / Súprava nástr. klúčov / Garnitura nasadnih ključev / Antgalių rinkinys / Muciņu komplekts / Padrunikoplekt / Гедоре компл / Šesterokutne kapice / Gedora set / Συλλογή καρδακιών / Llaves de vaso / Set di boccole / Kit de bicos / Jeu de douilles / Set van doppen

9, 10, 11, 12, 13, 14, 15, 16, 17, 19 mm
przetyczka 1 szt.

1 x punches

1 x шпиль

Wewnętrzna spirala powoduje samoczynne zaciskanie się na uszkodzonej śrubie/nakrętce umożliwiając bezpieczne odkręcenie

The innovative spiral profile digs itself into the head of a damaged screw/nut and thereby allows to loosen it securely

Внутренняя спираль вызывает автоматическое зажатие поврежденного болта/гайки, обеспечивая безопасное открывание

x11 3/8"



Ref.	☒	EAN
11-922	0/20	5907558436938

Przecinaki do nakrętek

Nut splitters / Meißel für Mutter / Гайколомы / Розривач до мутр / Csavaranyagóg / Dălți pentru piulițe / Trháč matic / Trhače matic / Lomilci matic / Veržilių kirstukai / Uzgriežņu cirtņi / Meisliid / Секачи за гайки / Rezač za maticе / Sekač navrtanja / Κόπτης παξιμαδιών / Tajadera de tuercas / Spraccadadi / Cortadores de porcas / Burins à écrous / Moerknippers

oczko 9 - 12 mm/klucz 12 mm; oczko 12 - 16 mm/klucz 14 mm; oczko 16 - 22 mm/klucz 19 mm; oczko 22 - 27 mm/klucz 21 mm

9 - 12 mm nut splitter. Spanner drive shaft 12 mm; 12 - 16 mm nut splitter. Spanner drive shaft 14 mm; 16 - 22 mm nut splitter. Spanner drive shaft 19 mm; 22 - 27 mm nut splitter. Spanner drive shaft 21 mm

размер гайки 9 - 12 мм / ключ 12 мм; размер гайки 12 - 16 мм / ключ 14 мм; размер гайки 16 - 22 мм / ключ 19 мм; размер гайки 22 - 27 мм / ключ 21 мм



Ref.	☒	EAN
11-925	0/10	5907558436945

Miska magnetyczna

Magnetic tray / Magnetschüssel / Поддон магнитный / Піддон магнітний / Mágneses tál, rozsdamentes / Tava magnetica / Magnetická miska / Magnetická miska / Magnetna posoda / Magnetinis dubenėlis / Magnētiskais trauks / Magnetkauss / Магнитен картер / Magnetska posuda / Magnetna činja / Μαγνητικός δίσκος / Plato magnético / Vassoio magnetico / Tacho magnético / Réceptier magnétique / Magnetische opvangbak



Ref.	L x W [mm]	☒	EAN
11-614	245 x 145	0/24	5907558419702

Chwytnak magnetyczny

Magnetic holder / Magnetgreifer / Магнитный захват / Тримач магнітний / Mágneses csavarkiszédő teleszkópos / Graifär magnetic / Magnetická úchytka / Magnetický zdvihák / Magnetno držalo / Magnetinis laikiklis / Magnētiskais satvērējs / Magnethaarats / Магнитен захват / Magnetska hvatajka / Magnetni hvatač / Μαγνητική αρπάγη / Agarrador magnético / Supporto magnetico / Сацamba magnética / Preneuse magnétique / Magnetisch houder



Ref.	☒	EAN
11-610	0/200	5907558418569

LED



Ref.	☒	EAN
11-611	0/100	5907558418576

Lusterko inspekcyjne

Inspection mirror / Inspektionsspiegel / Зеркало инспекционное / Дзеркальце інспекційне / Vizsgálótükör teleszkópos nyéllel / Oglindă de inspecție / Zrcadlo pro inspekční kontroly / Inšpekčné zrkadlo / Kontrolno ogledalo / Vaizdo veidrodelis / Inspekcijas spogulis / Kontrollpeegel / Контролно огледалце / Kontrolno ogledalo / Ogljedalo za inspekciju / Καθρεπτάκι ελέγχου / Espejo de inspección / Specchietto per ispezione / Espelho de inspeção / Miroir d'inspection / Inspectiespiegel



Ref.	☒	EAN
11-612	0/200	5907558418583

Refraktometr

Refraktometer / Refraktometer / Рефрактометр / Refraktometър / Refraktométer / Refraktometru / Refraktometr / Refraktometer / Refraktometer / Refraktometras / Refraktometrs / Refraktomeeter / Рефрактометър / Refraktometar / Refraktometar / Διαλασίμετρο / Refractómetro / Rifraktometro / Refratómetro / Réfractomètre



Ref.	☒	EAN
11-270	0/50	5907558436020



Nitownica

Riveter / Nietmaschine / Заклепочник / Клепальный инструмент / Popszegecszűző / Maszina de nituit / Nýtovačka / Kliešte nitovacie ocelové / Pištola za kovičenje / Kniedklis / Kniežu stangas / Needitangid / Humачка / Klijesta za zakovice / Pistolj za pop nitre / Ηλοι / Remachadora / Rivettatrice / Rebitadora / Riveuse / Klinkagelmachine



Steel	Ø 2,4/3,0/3,2/4,0/4,8/5,0 mm	Al	Ø 2,4/3,0/3,2/4,0/4,8/5,0 mm
Cu	Ø 2,4/3,0/3,2/4,0/4,8/5,0 mm	Stainless Steel	Ø 2,4/3,0/3,2/4,0 mm

Ref.	Ø [mm]	L [mm]	⊠	EAN
18-101	2,4/3,2/4,0/4,8	264	10/30	5907558400137



Steel	Ø 2,4/3,0/3,2/4,0/4,8/5,0 mm	Al	Ø 2,4/3,0/3,2/4,0/4,8/5,0 mm
Cu	Ø 2,4/3,0/3,2/4,0/4,8/5,0 mm	Stainless Steel	Ø 2,4/3,0/3,2/4,0/4,8/5,0 mm

Ref.	Ø [mm]	L [mm]	⊠	EAN
18-103	2,4/3,2/4,0/4,8	265	10/30	5907558405811

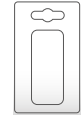

Steel	Ø 2,4/3,0/3,2/4,0/4,8/5,0/6,0/6,4 mm	Al	Ø 2,4/3,0/3,2/4,0/4,8/5,0/6,0/6,4 mm
Cu	Ø 2,4/3,0/3,2/4,0/4,8/5,0/6,0/6,4 mm	Stainless Steel	Ø 2,4/3,0/3,2/4,0/4,8/5,0/6,0/6,4 mm

Ref.	Ø [mm]	L [mm]	m [kg]	⊠	EAN
18-106	3,2/4,0/4,8/6,0/6,4	480	1,95	0/10	5907558412246



Steel	Ø 2,4/3,0/3,2 mm	Al	Ø 2,4/3,0/3,2/4,0/4,8/5,0 mm
Cu	Ø 2,4/3,0/3,2 mm	Stainless Steel	Ø 2,4 mm

Ref.	Ø [mm]	L [mm]	⊠	EAN
18-102	2,4/3,2/4,0/4,8	280	10/20	5907558400144

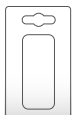

Steel	Ø 2,4/3,0/3,2/4,0/4,8 mm	Al	Ø 2,4/3,0/3,2/4,0/4,8 mm
Cu	Ø 2,4/3,0/3,2/4,0/4,8 mm	Stainless Steel	Ø 2,4/3,0/3,2/4,0/4,8 mm

Ref.	Ø [mm]	L [mm]	m [kg]	⊠	EAN
18-107	2,4/3,2/4,0/4,8	275	0,75	6/24	5907558413564

Lampa lutownicza

Liquid gas blow-lamp / Lötlampe / Лампа паяльная / Газ рідкий для лампи паяльної / Forrasztókészülék / Lampă sudat cu gaz lichid / Pájeci lampa / Pájekovačka plynová / Plinski gorilnik / Litavimo lempa / Lodlampa / Jootelamp (vedelgaas) / Лампа газова / Plinska lemliica / Gasna lemliica / Καμινέτο υγραερίου / Lámpara de soldar a gas / Lampada per saldare / Lämpada p. Soldar / Lampe à braser / Soldeerlamp



1.2 kW
87 g/h
FOR 190g CARTRIDGE

Ref.	T [°C]	q [g/h]	P [kW]	⊠	EAN
20-021	1350	87	1.2	0/12	5907558455151



PIEZO
1.2 kW
87 g/h
FOR 190g CARTRIDGE

Ref.	info	T [°C]	q [g/h]	P [kW]	⊠	EAN
20-022		1350	87	1.2	0/12	5907558455168
20-045	+ 4 x 20-033	1350	87	1.2	0/12	5907558488265



Palnik gazowy

Gas burner / Gasbrenner / Горелка газовая / Пальник газовой / Forrasztófej / Arzător de gaz / Plynový hořák / Horák / Plinski gorilnik / Dujinis degiklis / Gāzes deglis / Gaaspöleti / Нагрівник за горелка / Nastavak za plamenik / Gasna lemilica / Καυστήρας υγραερίου / Soplete / Bescuccio / Maçarico de gás / Chalumeau à gaz / Gasbrander



Ref.	info	T [°C]	P [kW]	☒	EAN
20-025		1300	1.3	10/100	5907558449648
20-041	+ 20-030	1300	1.3	10/100	5907558486773
20-040	+ 2 x 20-030	1300	1.3	10/100	5907558465747



Ref.	T [°C]	P [kW]	☒	EAN
20-026	1350	1.28	10/60	5907558465365

Nabój z gazem butan

Butane gas cartridge / Butan-Gas-Patrone / Баллон с газом бутан / Балончики (картриджи) з газом бутан / Tartály gázlámpához / Cartuş cu gaz butan / Kartuşe s plynem butan / Butánová kartuša / Jeklenka s plinom butan / Butano dujų balionas / Balons ar butāna gāzi / Butaan-gaaspadrun / Бутилка с газ бутан / Patrona sa butan plinom / Patrona sa butan gasom / Δοχείο με μείγμα βουτανίου / Cartucho de gas butano / Bombola di gas / Cartuxo com gás / Cartouche avec gaz butane / Butaan vervangcartridge



Butan

EN417:
2012



Butan

EN417:
2012



Ref.	m [g]	☒	EAN
20-033	190	0/48	5907558468939



Ref.	m [g]	☒	EAN
20-030	227	4/28	5907558449655



Butan

EN417:
2012



Ref.	m [g]	☒	EAN
20-036	500	0/12	5907558468946



Mikropalnik

Microtorch / Mikrobrenner / Микрогорелка / Мініпаяльнік / Forrasztókészülék piezos / Microinjector / Mikrohořák / Mikro rajkovačka / Gorilnik / Mikro degiklis / Lodlampa mini / Mikroelekklamp / Горелка микро / Mikro Plínska lemliica / Mikro gasna lemliica / Φλόγιστρο / Microsoplete / Micro bruciatore / Mikromaçarico / Micro-brûleur / Microbrander



Ref.	☒	EAN
19-904	0/40	5907558465716



Ref.	☒	EAN
19-905	0/40	5907558465723



Ref.	☒	EAN
19-906	50/200	5907558465730

Lutownica bezprzewodowa

Cordless soldering iron / Kabelloser LötKolben / Аккумуляторный паяльник / Аккумуляторный паяльник / Akkumulátoros forrasztóraka / Fier de lipit fără fir / Akumulátorová ráječka / Bezdrôtová sprájkovačka / Brezžični sprajkalnik / Belaidis lituoklis / Bezvadu lodātmurs / Juhtmeta jootekolb / Безжичен паяльник / Bežično lemilo / Безжична лемпица / Ασύρματο κολλητήρι / Soldador inalámbrica / Soldatore a batteria / Ferro de soldar sem fios / Fer à souder sans fil / Draadloze soldeerbout



Ref.	☒	EAN
19-250	10/20	5907558491449

Stacja lutownicza

Soldering station / Lötstation / Паяльная станция / Паялна станция / Forrasztóállomás / Stație de lipit / Pájeci stanice / Sprájkovacia stanica / Sprajkalna postaja / Litavimo stotis / Lodēšanas stacija / Jootejāam / Станция за запояване / Postaja lemliice / Stanica lemliice / Σταθός κόλλησης / Estación de soldadura / Stazione di saldatura / Estação de solda / Poste de soudure / Soldeerstation



Ref.	☒	EAN
19-200	0/12	5907558468908

Kolba lutownicza

Soldering tool / LötKolben / Паяльник / Паялна колба / Forrasztóraka / Fier de lipit / Pájeci ručka / Sprájkovacie pero / Sprajkalnik / Lituoklis / Lodātmurs / Jootekolb / Паяльник / Lemliica / Lemliica / Κολλητήρι / Soldador / Soldatore / Ferro de soldar / Fer à souder / Soldeerbout



Ref.	☒	EAN
19-220	0/80	5907558468915

Końcówki do lutownicy

Soldering tips / Lötspitzen / Наконечники для паяльника / Наконечники до лютувальника / Forrasztóhegyek / Capete pentru ciocan de lipit / Копцовку про рајечку / Nástavec sprájkovačky / Konice za sprajkalnik / Antgali ai lituokliui / Lodēšanas uzgali / Jootekolbi otsakud / Накрайници за паяльника / Vrhovi za lemliicu / Nastavci za lemjenje / Μύτες κολλητηριού / Voquillas para soldar / Inserti per soldatore / Ponteiros p. soldador / Embouts de fer à souder / Soldeereindstukken



Ref.	☒	EAN
19-225	0/500	5907558468922



Lutownica transformatorowa

Soldering gun / Trafo-Lötkolben / Паеньник трансформаторный / Паеньний пістолет / Forrasztópisztoly / Ciocan de lipit / Pájeci stanice s transformátorem / Pájekovačka elektronická / Spajkalnik / Transformatorinis lituoklis / Lodāmurs ar transformātoru / Jootepüstol / Поеньник / Pištolj lemilica / Pistolj lemilica / Ηλεκτρικό κολλητήρι με μετασχηματιστή / Pistola para soldar / Pistola per saldatura / Soldador por transformador / Fer à souder redresseur / Transformator soldeerbout



Ref.	⊠	EAN
19-152	0/10	5907558472059



Ref.	⊠	EAN
19-151	0/10	5907558464696



Ref.	⊠	EAN
19-153	0/6	5907558472066



Wyciskacz do tub

Caulking gun / Auspresser für Tuben / Выжиматель / Толк для витискання монтажноі піни / Kinyomópisztoly / Comprimator de tuburi / Aplikační pistole na tuby / Vytlačáč túb / Pištola za tube / Hermetiko pistoletas / izspiedējs / Torutõmmits / Изтисквач за туби / Istiskivač za tube / Istiskivač za tube / Πιστόλι σιλικόνης / Pistola para tubos / Pistola per cartucce / Espremedor para tubos / Pistolet pour tubes / Afichtingspistool



Ref.	L [mm]	⊠	EAN
61-001	240	0/24	5907558405842



Ref.	L [mm]	⊠	EAN
61-002	240	0/12	5907558405859



3 trzpienie wyciskające
3 forcing pins
3 отжимных штифта

Ref.	L [mm]	⊠	EAN
61-004	240	0/12	5907558420821



Ref.	V [ml]	L [mm]	⊠	EAN
61-005	310	254	0/12	5907558420838
61-006	600	389	0/12	5907558420845





NARZĘDZIA I AKCESORIA PNEUMATYCZNE

pneumatic
tools and accessories

пневматичні інструменти
та аксесуари

Klucz pneumatyczny udarowy

Pneumatic impact wrench / Pressluftschlagschlüssel / Ключ пневматический ударный / Ключ пневматичний ударний / Pneumatikus ütvecsavarozó / cheie pneumatică de lovit / Pneumatický nárazový klič / Pneumatická rázová utahovačka / Pnevmatiski udarni vijajč / Pneumatinis, smūginis veržliaraktis / Pnevmatiskā sitieta pistole / Pneumatiline löök-mutrivõti / Γαύκοεργπ пневματιχεν / Pnevmatiski Klič udarni / Pnevmatiski ključ / Σηραι αέρος αναστρεφόμενο / Llave de impacto neumática / Chiave pneumatica a percussione / Chave pneumática de impacto / Clef pneumatique à chocs / Pneumatisch slagsleutel

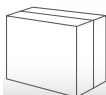

Ref.	⊠	EAN
14-002	1/6	5907558442533

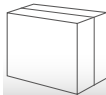

Ref.	⊠	EAN
14-008	1/4	5907558442564

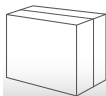

Ref.	⊠	EAN
14-006	1/6	5907558442557

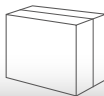

Ref.	⊠	EAN
14-004	1/6	5907558442540

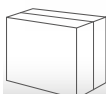

Ref.	⊠	EAN
14-500	1/10	5907558442557



1/2" -9, 10, 11, 13, 14, 17, 19, 22, 24, 27 mm

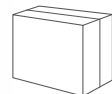

Ref.	⊠	EAN
14-502	1/5	5907558444841

Klucz pneumatyczny udarowy

Pneumatic impact wrench / Pressluftschlagschlüssel / Ключ пневматический ударный / Ключ пневматичний ударний / Pneumatikus ütvecsavarozó / cheie pneumatică de lovit / Pneumatický nárazový klíč / Pneumatická rázová uťahovačka / Pnevmatiski udarni vijač / Pnevmatinis, smūginis veržliaraktis / Pnevmatiskā sitiņa pistole / Pnevmatiline löök-mutrivõti / Γαϊτζοεργον пневματιčen / Pnevmatiski Ključ udarni / Pnevmatiski ključ / Σφυρί αέρος αναστρεφόμενο / Llave de impacto neumática / Chiave pneumatica a percussione / Chave pneumática de impacto / Clef pneumatique à chocs / Pneumatisch slagsleutel



Ref.	☒	EAN
14-010	1/1	5907558442571

Klucz kątowy pneumatyczny

Pneumatic angle wrench / Winkelschlüssel pneumatisch / Ключ угловой пневматический / Мутроверт кутювий пневматичний / Pneumatikus racsnis kulcs / Cheie unghiulară, pneumatică / Uhlový klíč pneumatický / Pneumatický uhlový klíč / Pnevmatiska raglja / Pnevmatinis kampinis raktas / Pnevmatiskā leņķu atslēga / Pnevmatiline nurkvõti / Ёлов пневматичен ключ / Pnevmatiski kutni ključ / Pnevmatiski ugaoni ključ / Κλειδί γωνιακό αέρος / Llave articulada neumática / Chiave pneumatica angolare / Chave de canto pneumático / Clef d'angle pneumatique / Pneumatisch haaksleutel



Ref.	☒	EAN
14-012	1/20	5907558442588

Klucz udarowy kątowy

Angle impact driver / Winkel-Schlag-Schlüssel / Ударный ключ / Ударний кутювий ключ / Ётvecsavarozó sarokkulcs / Cheie de impact unghiulară / Rázový rohový klíč / Uhlový rázový klíč / Kotni udarni ključ / Kampinis smūginis veržliasukas / Leņķveida triecienuzgriežņu atslēga / Nurga-löökvõti / Ёлов ударен ключ / Udarni kutni ključ / Ugaoni udarni ključ / Ασροκλειδί κροατικός / Llave de impacto angular / Chiave a percussione angolare / Chave de impacto angular / Clé à choc angulaire / Haakse slagmoersleutel

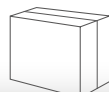

Ref.	☒	EAN
14-019	0/10	5907558469011

Szlifierka pneumatyczna kątowa

Pneumatic angle grinder / Pressluftwinkelschleifer / Машина шлифовальная угловая пневматическая / Шліфмашина пневматична наріжна / Pneumatikus csiszoló / Maşină pneumatică de şlefuit sub unghi / Pneumatická bruska úhlová / Brúska pneu. uhlová / Kotni pnevmatiski brusilnik / Pnevmatinis kampinis šlifuoکتis / Pnevmatiskā leņķa slīpmaşina / Pnevmatiline nurklīhvīmismasin / Ёловшліф пневматичен / Pnevmatiska kutna brusilica / Pnevmatiska brusilica / Γωνιακός τροχός αέρος / Amoladora neumática angular / Retificatrice pneumatica angolare / Disco de limar p. cantos pneumático / Meuleuse pneumatique d'angle / Pneumatische verstekschuurmachine

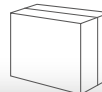

Ref.	☒	EAN
14-016	1/20	5907558442601

Szlifierka prosta pneumatyczna

Pneumatic straight grinder / Schleifmaschine gerade pneumatisch / Прямой пневматический шлифовальный аппарат / Шліфмашина пряма пневматична / Pneumatikus egyenes csiszológép / Polizor simplu, pneumatic / Přímá pneumatická bruska / Pneumatická jednoduchá brúska / Pnevmatiski premi brusilnik / Pnevmatinis, tiesinis šlifuoکتis / Pnevmatiska taisna slīpmaşina / Pnevmatiline līhtlīhvija / Обикновен пневматичен шлайф / Pnevmatiska jednostavna brusilica / Pnevmatiska prosta obična brusilica / Ευθείας λειαντήρας αέρος / Amoladora neumática recta / Smerigliatrice pneumatica dritta / Disco de limar reto pneumático / Meuleuse droite pneumatique / Pneumatische rechte schuurmachine

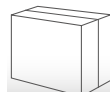

Ref.	☒	EAN
14-014	1/20	5907558442595

Szlifierka oscylacyjna pneumatyczna

Pneumatic finishing sander / Vibrationsschleifer pneumatisch / Колебательный пневматический шлифовальный аппарат / Шліфмашина осциляційна пневматична / Pneumatikus vibrációs csiszoló / Polizor oscilatoriu, pneumatic / Oscilační pneumatická bruska / Pneumatiskā vobračnā brúska / Pnevmatiski vibrācijaski brusilnik / Vibracinis, pneumaticinis šlifuoکتis / Pnevmatiska oscilācijas slīpmaşina / Pnevmatiline taldlīhvija / Осцилаторен пневматичен шлайф / Pnevmatiska vibrācijaska brusilica / Pnevmatiska oscilatorna brusilica / Παλμικό τριβείο αέρος / Lijadora neumática orbital / Levigatrice a delta pneumatica / Disco de limar oscilante pneumático / Meuleuse oscillatoire pneumatique / Pneumatische oscillatie schuurmachine

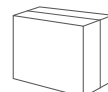

Ref.	☒	EAN
14-018	1/10	5907558442618



Szlifierka pneumatyczna kątowa

Pneumatic angle grinder / Pressluftwinkelschleifer / Машина шлифовальная угловая пневматическая / Шліфмашина пневматична накрісна / Pneumatikus csiszoló / Maşină pneumatică de şlefuit sub unghi / Pneumatická bruska úhlová / Brúška pneu. uhlová / Kotni pnevmatski brusilnik / Pneumatinis kampinis šlifjuoklis / Pneimatsiskā leņķa slīpmašīna / Pneumaatiline nurklihvimisasin / Ёлошлайф пневматичен / Pneumatska kutna brusilica / Pneumatska brusilica / Γωνιακός τροχός αέρος / Amoladora neumática angular / Retificatrice pneumatica angolare / Disco de limar p. cantos pneumático / Meuleuse pneumatique d'angle / Pneumatische versteckschuurmachine



Ref.	☒	EAN
14-508	1/10	5907558444858

Wiertarka pneumatyczna

Pneumatic drill / Bohrmaschine pneumatisch / Дрель пневматическая / Дріль пневматичний / Pneumatikus fűréségép / Masina de gaurit pneumatica / Pneumatická vrtačka / Pneumatiská vrtačka / Pnevmatiski vrtalnik / Pneumatinis gręžtuvas / Pneimatsiska urbjmašīna / Pneumaatiline trell / Пневматична пробивна машина / Pneumatska bušilica / Pneumatska bušilica / Δράπανο αέρος / Taladradora neumática / Трапано pneumático / Berbequim pneumático / Erçeuse pneumatique / Pneumatische boormachine

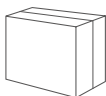

Ref.	☒	EAN
14-026	1/10	5907558442632

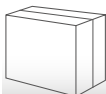
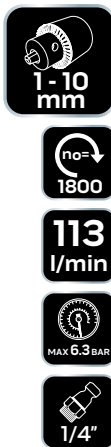

Ref.	☒	EAN
14-514	1/10	5907558444865

Szlifierka mimośrodkowa pneumatyczna

Pneumatic orbital sander / Exzentrerschleifer pneumatisch / Машина шлифовальная эксцентриковая пневматическая / Шліфмашина ексцентрикова пневматична / Pneumatikus excenterszisoló / Polizor excentric, pneumatic / Pneumatiská excentrická bruska / Pneumatiská excentrická brúška / Pnevmatiski ekscentrični brusilnik / Pneumatinis, ekscentrinis šlifjuoklis / Pneimatsiska ekscentriskā slīpmašīna / Pneumaatiline ekstsentrklihvija / Пневматичен ексцентършлайф / Pneumatska ekscentarska brusilica / Pneumatska ekscentrična brusilica / Εκκεντρο τρίβείο αέρος / Lijadora neumática excéntrica / Levigatrice rotoorbitale pneumatica / Disco de limar para excêntrico pneumático / Meuleuse excentrique pneumatique / Pneumatische excenter schuurmachine

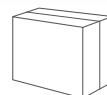

Ref.	☒	EAN
14-013	0/10	5907558469028

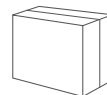

Ref.	☒	EAN
14-020	1/12	5907558442625

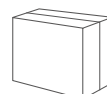

Ref.	☒	EAN
14-510	1/10	5907558446357

Pneumatyczny młotek igłowy czołowy

Pneumatic butt-face needle hammer / Pneumatischer Front-Nadelhammer / Пневматический игольчатый зачистной молоток / Голкобий пневматичний торцевий молоток / Pneumatikus homlok tűkalapács / Ciocan cu ace pneumatic frontal / Čelní pneumatické jehlové kladivo / Čelové pneumatické ihlicové kladivo / Pnevmatisko koničasto kladivo / Pneumatinis adatinis plaktukas / Pnevmatiskais priekšējais adatu āmurs / Pnevmaatiline ots-nõelhaamer / Пневматичен челен иглен чук / Pnevmatiski iglasti čioni čekić / Čioni pnevatiski iglasti čekić / Μηροστικό πνευματικό σφύρι βελόνας / Martillo neumático de aguja frontal / Martello pneumatico ad aghi / Martelo de agulha frontal pneumático / Marteau pneumatique à aiguilles frontal / Pneumatische naaldbikhamer



Ref.	⊠	EAN
14-031	0/10	5907558468977



Ref.	⊠	EAN
14-032	1/6	5907558468984

Młotek udarowy pneumatyczny

Pneumatic impact hammer / Schlaghammer pneumatisch / Молоток ударный пневматический / Перфоратор пневматичний / Pneumatikus vésőkalapács / Ciocan cu percucie pneumatică / Pneumatické rázové kladívko / Pneumatické príklepové kladívko / Pnevmatisko udarno kladivo / Pneumatinis atskėlimo plaktukas / Pnevmatiskais sitarnais āmurs / Pnevmaatiline löökvasar / Пневматичен ударен чук / Pnevmatiski udarni čekić / Udarni pnevatiski čekić / Κρουστική σφύρα αέρος / Martillo neumático de impacto / Martello pneumatico / Martelo de impacto pneumático / Martelet à chocs pneumatique / Pneumatische slaghamer



Ref.	⊠	EAN
14-028	1/5	5907558442649

Przecinarka pneumatyczna

Air Cut-Off Tool / Pneumatisches Schneidegerät / Пневматический резак / Пневматичний різальний станок / Pneumatikus vágó / Máquina de táiat pneumática / Pneumatická řezačka / Pneumatická píla / Pnevmatiski rezalnik / Pnevmatinis pjoviklis / Pnevmatiskais griezējs / Pnevmaatiline lõikur / Пневматичен фреза / Pnevmatiski rezač / Pnevmatiska seckalica / Εργαλείο διακοπής αέρα / Cortador neumático / Troncatrice pneumatica / Cortador pneumático / Dispositif de coupe pneumatique / Pneumatische doorslijpmachine



Ref.	⊠	EAN
14-017	0/20	5907558468991

Piła pneumatyczna

Air Body Saw / Luftkörpersäge / Воздушная пила / Пневматична пила для мина / Pneumatikus fűrész a testhez / Ferästräu pneumatic pentru caroserie / Pneumatická píla / Pneumatická píla / Pnevmatiska žaga / Pnevmatinis pjūklas / Pnevmatiskais zāģis / Pnevmaatiline saag / Pnevmatiska píla / Пневматска тесетра / Αεροπίλοιο / Sierra neumática / Sega pneumática / Serra pneumática / Scie pneumatique / Pneumatische zaag



Ref.	⊠	EAN
14-034	0/25	5907558469004

Dłuta komplet

Chisel set / Beilsetz / Набор долот / Зубила та пробивачи / Vésőkészlet / Set dălți / Sada dlát / Súprava dlát / Garnitura dlet / Kaltu komplektas / Kaltu komplekts / Peitlile komplekt / Сечачи и шило / Špica / Sekac / Συλλογή από σμίλες / Juego de formones / Set di scalpelli / Conjunto de Raspadores / Jeu de ciseaux



Ref.	⊠	EAN
14-029	4/24	5907558455298

Sprężyny

Springs / Federn / Пружини / Пружини / Rugă készlet / Arcuri / Pružiny / Pružiny / Vzmeti / Spryruokliu rinkiny / Atsperes / Vedrud / Пружини / Opruge / Opruge / Σετ ελατήρια / Espirales / Molle / Molas / Ressorts / Veren



Ref.	⊠	EAN
14-030	4/40	5907558455304



Zszywacz pneumatyczny

Pneumatic stapler / Pneumatische Heftmaschine / Стеллер пневматический / Стеллер пневматичний / Pneumatikus tűzőgép / Capsator pneumatic / Pneumatická sešivačka / Pneumatická zošivačka / Pnevmatiski spenjač / Pneumatinis kablių pistoletas / Pnevmatiskais skavotājs / Pneumaatiline klambripūstol / Пневматичен телбод / Pneumatska klamerica / Pneumatska heftalica / Συρραπτικό αέρος / Grapadora neumática / Graffettatrice pneumatica / Máquina de pontear pneumática / Agrafeuse pneumatique / Pneumatische hechtmaschine

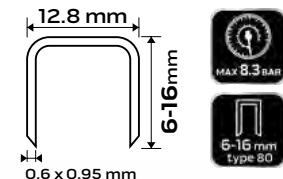
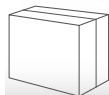

Ref.	☒	EAN
14-572	0/10	5907558444889

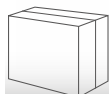
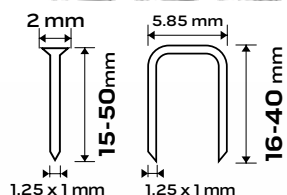

Ref.	☒	EAN
14-570	0/10	5907558444872

Zszywki

Staples / Klammern / Скобы / Скобы / Tűzőkapocs / Capsator / Sešivací spony / Sponky / Sponke / Kabés / Skavas / Klambriid / Телчета / Municija za klamericu / Heftalica / Συρραπτήρες / Grapas / Puntis metallici / Pontas / Agrafes / Hechters

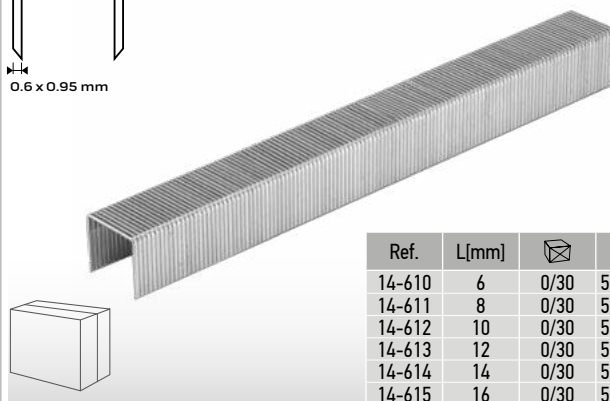
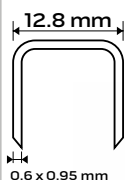

Ref.	L[mm]	☒	EAN
14-610	6	0/30	5907558453720
14-611	8	0/30	5907558453737
14-612	10	0/30	5907558453744
14-613	12	0/30	5907558453751
14-614	14	0/30	5907558453768
14-615	16	0/30	5907558453775

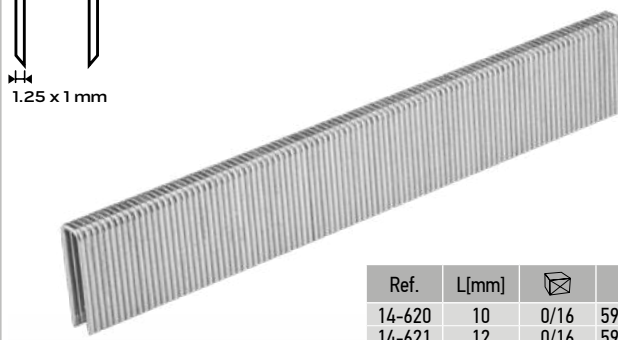
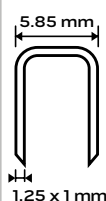

Ref.	L[mm]	☒	EAN
14-620	10	0/16	5907558453782
14-621	12	0/16	5907558453799
14-622	15	0/16	5907558453805
14-623	20	0/12	5907558453812
14-624	22	0/12	5907558453829
14-625	25	0/12	5907558453836
14-626	28	0/12	5907558453843
14-627	30	0/12	5907558453850
14-628	32	0/8	5907558453867
14-629	35	0/8	5907558453874
14-630	38	0/6	5907558453881
14-631	40	0/6	5907558453898

Gwoździe

Nails / Nägel / Гвозди / Цявхи / Tűzőszeg / Cuie / Hřebíky / Klince / Želji / Vinys / Naglas / Naelad / Пирони за тапер / Čavlići za pneumatsku klamericu / Municija za heftalicu / Καρφιά / Clavos / Chiodi / Pontas / Agrafes / Spijkers

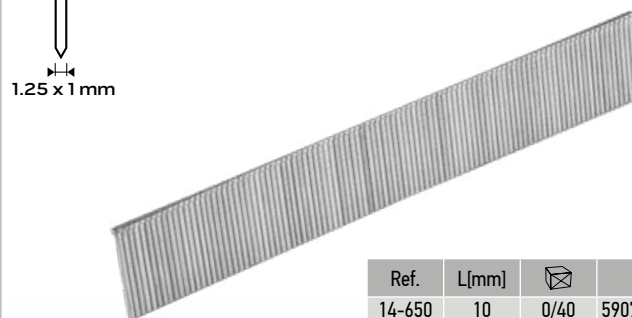
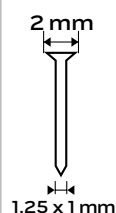

Ref.	L[mm]	☒	EAN
14-650	10	0/40	5907558453904
14-651	15	0/20	5907558453911
14-652	20	0/20	5907558453928
14-653	25	0/20	5907558453935
14-654	30	0/20	5907558453942
14-655	35	0/12	5907558453959
14-656	40	0/12	5907558453966
14-657	45	0/12	5907558453973
14-658	50	0/12	5907558453980

Nasadka udarowa

Impact socket / Schlagaufsatz / Насадка ударная / Патрон перфораторный / Gépi dugókulcs / Brütőtarú cs percütje / Příklepový nástavec / Příklepový nástavec / Udarni nasadni ključ / Antgalis kalimui / Triecienuzgalis / Lööksotsak / Ударна наставка / Udarni nasadni nastavak / Udarna karica / Υποδοχή κρουστικού αναλλακτικού / Llave de vaso para atornilladores de impacto / Bussola esagonale / Bocal de impacto / Douille à choc / Slagkop

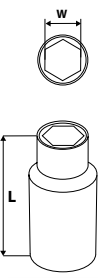

CrMo
steel

Ref.	W[mm]	L[mm]	☒	EAN
12-210	10	38	20/200	5907558423808
12-212	12	38	20/200	5907558423822
12-213	13	38	20/200	5907558423839
12-214	14	38	20/200	5907558423846
12-215	15	38	20/200	5907558423853
12-216	16	38	20/200	5907558423860
12-217	17	38	20/200	5907558423877
12-219	19	38	20/200	5907558423884
12-221	21	38	20/200	5907558423891
12-222	22	38	20/200	5907558423907
12-224	24	38	20/200	5907558423914

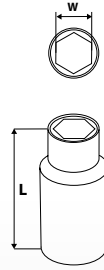

CrMo
steel

Ref.	W[mm]	L[mm]	☒	EAN
12-310	10	78	10/100	5907558423921
12-312	12	78	10/100	5907558423945
12-313	13	78	10/100	5907558423952
12-314	14	78	10/100	5907558423969
12-315	15	78	10/100	5907558423976
12-316	16	78	10/100	5907558423983
12-317	17	78	10/100	5907558423990
12-319	19	78	10/50	5907558424003
12-321	21	78	10/50	5907558424010
12-322	22	78	10/50	5907558424027
12-324	24	78	10/50	5907558424034



1/2" - 10, 12, 13, 14, 16, 17, 19, 21, 22, 24 mm

CrV
steel 1/2" x10



Ref.	☒	EAN
12-101	0/20	5907558414509

1" - 27, 30, 32, 35, 36, 38, 41, 42, 50 mm

CrMo
steel 1" x9



Ref.	☒	EAN
12-105	0/2	5907558414530

1/2" - 10, 11, 12, 13, 14, 16, 17, 19, 21, 22, 24 mm

CrV
steel 1/2" x11



Ref.	☒	EAN
12-102	0/10	5907558414516

E10, E11, E12, E14, E16, E18, E20, E22, E24

CrMo
steel 1/2" x9



Ref.	☒	EAN
12-110	0/20	5907558414554

1/2" - 10, 12, 13, 14, 15, 17, 19, 21, 22, 24 mm

CrMo
steel 1/2" x10



Ref.	☒	EAN
12-107	0/10	5907558414547

3/4" - 126, 27, 29, 30, 32, 35, 36, 38 mm

CrMo
steel 3/4" x8



Ref.	☒	EAN
12-115	0/6	5907558414523



CrMo
steel

Ref.	☒	☒	EAN
10-258	T30	1/10	5907558469660
10-259	T40	1/10	5907558469677
10-260	T45	1/10	5907558469684
10-261	T50	1/10	5907558469691
10-262	T55	1/10	5907558469707
10-263	T60	1/10	5907558469714
10-264	T70	1/10	5907558469721
10-265	T80	1/10	5907558469738



Klucze udarowe torx

Impact Torx bit socket set / Torx-Schlagschrauber-Satz / "Набор ударных торцовых ключей Torx" / Набор ключей ударных «Торх» / Torx gépi kulcsok / Chei cu impact torx / Nástrčné kľúče torx / Rázové kľúče torx / Udarni nasadni ključ Torx / Smitüginiai raktai „TORX“ / Triecienatslēgas torx / Torx-löökvõrtmed / Ударни ключове torx / ударни ključevi torx / Ударни ključevi torx / Σετ κρουσικά μπουλονόκλειδα Torx / Llaves de impacto torx / Inserti Torx / Jogo de chaves de percussão torx / Clés à choc torx / Torx slagsleutels

★ T25, T27, T30, T40, T45, T50, T55, T60



Ref.	☒	EAN
08-712	0/20	5907558418620

★ T30, T40, T45, T50, T55, T60, T70, T80



Ref.	☒	EAN
10-257	1/10	5907558469653

Przedłużka udarowa

Impact extension / Wirkungsverlängerung / Ударный удлинитель / Ударний Подовжувач / Toldósár / Prelungitor / Prodlužovák / Predĺženie / Podaljšek / Ilgiklis / Pagarinātājs / Pikenodus / Удължител / Produženi poluga / Produzена poluga / Προέκταση / Alargadera / Prolunga / Extensão / Prolongation / Verlengstuk



Ref.	L[mm]	☒	EAN
10-250	50	1/10	5907558469585
10-251	75	1/20	5907558469592
10-252	125	1/10	5907558469608

Przegub udarowy

Impact joint / Schlaggelenk / Ударный шарнир / Ударний шарнір / Csukló / Articulație de impact / Nárazový kloub / Nárazový čap / Udarma zglob / Lankstas / Sarnirs / Klamber / Шарнир / Zglob / Zglob / Μεντεσές / Articulación / Snodo / Articulação / Articulation / Spilverbinding



Ref.	Info	☒	EAN
10-253	1/4"	1/20	5907558469615
10-254	3/8"	1/20	5907558469622
10-255	1/2"	1/10	5907558469639

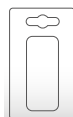

Ref.	☒	EAN
10-256	1/10	5907558469646

Zestaw do uzdatniania powietrza

Air treatment kit / Luftaufbereitungsset / Набор для очистки воздуха / Комплект до підготовки повітря / Levegőelőkészítő egység / Garnitură de innoobilarea aerului / Sada pro úpravu vzduchu / Súprava na upravanje vzduchu / Komplet za obdelavo zraka / Suslęgto oro apdorojimo įrenginys / Gaisa attīršanas komplekts / Ошудухастускомплект / Комплект за подготовка на въздуха / Set za pripremu zraka / Pribor za tretiranje vazduh / Σετ καθαρισμού αέρος / Dispositivo de procesamiento del aire / Filtro, riduttore, lubrificatore / Kit para purificar ar / Jeu pour traitement d'air / Set van mondstukken voor zandblazen



Ref.	☒	EAN
14-734	1/25	5907558452235

Filtr odwadniacz

Draining filter / Entwässerungsfilter / Фильтр / Фильтр сепараторный / Víztelenítő szűrő, fémházas / Filtru - dezodorizant / Odvodňovací filtr / Odvodňovací filter / Odvodni filter / Filtras- džiovintuvias / Atūdepošanas filtrs / Veefilter / Фильтр за отводняване / Filtar za uprjanje vode / Odvodni filter / Φίλτρο-διαχωριστής / Filtro de drenaje / Filtro di drenaggio / Filtro / Filtre purgeur / Filter drainage



Ref.	☒	EAN
14-732	1/50	5907558452228



Ref.	☒	EAN
14-730	1/25	5907558452211



Ref.	☒	EAN
14-550	1/125	5907558444896

Zestaw nasadek

Socket set / Aufsatzset / Набор головок торцевых / Набор насадок торцевых / Dugókulcs készlet alufelnihez, vékonyfalú / Set duze / Sada násadek / Súprava nástr. ključov / Garnitura nasadnih ključev / Antgalių rinkinys / Mucijų komplekts / Padrunikomplekt / Гедоре компл / Šesterkutne kapice / Gedora set / Συλλογή καρυδακιών / Llaves de vaso / Set di boccole / Kit de bicos / Jeu de douilles / Set van doppen

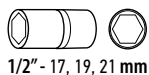

Ref.	☒	EAN
12-350	0/20	5907558435849

Przewód ciśnieniowy spiralny

High pressure spiral hose / Spiraldruckleitung / Шланг сжатого воздуха спиральный / Шланг високого тиску / Pneumatikus spiráltömlő / Furtun spiral presiune înaltă / Tlakové potrubí spirálové / Vysokotlaká spirálová hadica / Visokotlačna spiralna gibka cev / Spiralinė aukšto slėgio žarna / Spirälveida gaisa cauruļvads / Kõrgsurvevoolik (spiraal) / Маркуч за компресор / Spiralno crijevo najlonsko / Crevo za visoki pritisak / Σπυροειδής ρύγχος υψηλής πίεσης / Tubo de presión / Tubo a spirale in nylon / Cabo de tensão espiral / Durite de pression hélicoïdale / Spiraal drukleiding

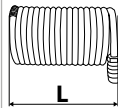

PU

MAX 8 BAR

+35°C
-10°C

Ref.	L [m]	⌀ [mm]	⊘ [mm]	☒	EAN
12-070	5	6,5	10,0	0/50	5907558414448
12-071	10	6,5	10,0	0/20	5907558414455
12-072	15	6,5	10,0	0/20	5907558414462
12-074	5	8,0	12,0	0/25	5907558414479
12-075	10	8,0	12,0	0/20	5907558414486
12-076	15	8,0	12,0	0/15	5907558414493

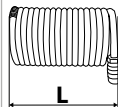

15 m

PU

MAX 8 BAR

Ref.	L [m]	⌀ [mm]	⊘ [mm]	☒	EAN
14-800	15	10,0	15,0	0/10	5907558444667
14-802	15	12,0	17,0	0/10	5907558444674

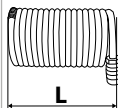

PP

8mm

5mm

MAX 8 BAR

Ref.	L [m]	⌀ [mm]	⊘ [mm]	☒	EAN
14-808	5	5,0	8,0	0/50	5907558457865
14-804	10	5,0	8,0	0/25	5907558444681
14-806	15	5,0	8,0	0/25	5907558444698

Przewód ciśnieniowy zbrojony

High pressure reinforced hose / Druckleitung verstärkt / Шланг високого давления армированный / Шланг високого тиску, армований / Pneumatikus tömlő / Furtun armat presiune înaltă / Tlakové potrubí vyztužené / Vysokotlaká hadica / Visokotlačna gibka cev / Sustiprinta aukšto slėgio žarna / Augstspiediena gaisa cauruļvads / Tugevdatud kõrgsurvevoolik / Маркуч за вис. налягане / crijevo za visoki pritisak / Crevo za visoki pritisak / Ενισχυμένος ρύγχος υψηλής πίεσης / Tubo de presión reforzado / Tubo a pressione rinforzato / Cabo de tensão armado / Durite de pression armée



PVC

+40°C
-10°C

Ref.	L [m]	⌀ [mm]	⊘ [mm]	P _{max} [bar]	☒	EAN
12-079	50	8,0	13,0	19	0/1	5907558414936
12-080	50	10,0	15,0	17	0/1	5907558414943
12-081	50	12,0	17,0	13	0/1	5907558414950



Zwijadło pneumatyczne

Pneumatic reel / Pneumatische Rolle / Пневматическая катушка / Пневматична катушка / Pneumatikus orsó / Bobina pneumatica / Pneumatický naviják / Pneumatický navijak / Pneumatski kolut / Pneumatine rité / Pneimatiskā spēle / Pneumatiline rull / Пневматична макара / Pneumatski kolut / Пневматски колулт / Πνευματικό καρούλι / Carrete neumático / Bobina pneumatica / Carretilha pneumática / Enrouleur pneumatique / Pneumatische haspel



Ref.	📦	EAN
10-700	1/1	5907558497359



Ref.	📦	EAN
10-701	1/1	5907558497366

Szybkozłączka

Quick coupler / Schnellkupplungen / Быстросъемная муфта / Муфта швидкорознімна / Pneumatikus gyorscsatlakozó / Conector rapid / Rychlospojka / Rýchlospojka / Hitra spojka / Greitoji jungtis / Ātrsavienotājs / Kiirühendus / Бърза връзка / Spojnica / Brzo odvajanje / Συζευκτήρας ταχείας απελευθέρωσης / Acoplador rápido / Connetture rapido con presa per tubo / União rápida / Rapport rapide / Snelkoppeling



Ref.	⌀ [mm]	⌀ [mm]	📦	EAN
12-600	4	6	0/36	5907558417685
12-601	6	8	0/27	5907558417692
12-602	8	10	0/27	5907558417708



Ref.	⌀ [mm]	📦	EAN
12-620	7	0/36	5907558417814
12-621	8	0/36	5907558417821
12-622	10	0/36	5907558417838
12-623	12	0/36	5907558417845



Ref.	⌀ [mm]	📦	EAN
12-630	7	0/36	5907558417890
12-631	8	0/36	5907558417906
12-632	10	0/36	5907558417913



Ref.	📏 ["]	📦	EAN
12-635	1/4	0/36	5907558417920
12-636	3/8	0/36	5907558417937
12-637	1/2	0/36	5907558417944



Ref.	📏 ["]	📦	EAN
12-645	1/4	0/36	5907558417975
12-646	3/8	0/36	5907558417982



Ref.	📏 ["]	📦	EAN
12-650	1/4	0/36	5907558417999
12-651	3/8	0/36	5907558418002

Złącze do węża

Hose connection / Schlauchverbinder / Соединители для шланга / Арматура до шлангу / Pneumatikus tömlőtoldó / Imbinare de furtun / Spojka pro hadici / Spoj na hadicu / Konektor za cev / Jungtis žarnai / Šļūtenes savienotāji / Voolikiühendused / Съединение за шланга / Spoj za cijev / Spoj za grevo / Συνδεσμοί εύκαμπτου σωλήνα / Junta para manguera / Connetture per tubo / União p. Mangueira / Raccord pour flexible / Verbindingsstuk voor slang



Ref.	⌀ [mm]	📦	EAN
12-610	6	0/36	5907558417739
12-611	8	0/36	5907558417746
12-612	10	0/36	5907558417753
12-613	12	0/36	5907558417760



Ref.	⌀ [mm]	📏 ["]	📦	EAN
12-615	6	1/4	0/36	5907558417777
12-616	10	1/4	0/36	5907558417784
12-617	10	1/2	0/36	5907558417791
12-618	12	1/2	0/36	5907558417807

Końcówka do szybkozłączeni

Quick coupler tip / Endstück für Schnellkupplung / Наконечник быстрого соединения / Насадка для швидко рознімної муфти / Pneumataikus csatlakozó külsőmenet- gyorsvég / Piesà de conectare rapidă / Koncovka pro rychlospojku / Nástavec rýchlospoja / Nastavek za hitro spojko / Greitaeigis jungties antgalis / Ātrsavienojuma uzgalis / Kiirühendusotsak / Накрайник за бърза връзка / nastavak za spojnicu / Kraj za brzo priključivanje / Κεφαλή ταχείας σύνδεσης / Voquilla para acoplador rápido / Connettore rapido con presa per tubo / Ponteiro do uniões rápidas / Embout pour raccord rapide / Eindstuk voor snelkoppeling



Ref.	⌀ [mm]	⌀ [mm]	⊠	EAN
12-605	6	8	0/27	5907558417715
12-606	8	10	0/36	5907558417722



Ref.	⌀ [mm]	⊠	EAN
12-625	7	0/36	5907558417852
12-626	8	0/36	5907558417869
12-627	10	0/36	5907558417876
12-628	12	0/36	5907558417883



Ref.	⊠ ["]	⊠	EAN
12-640	1/4	0/30	5907558417951
12-641	3/8	0/36	5907558417968



Ref.	⊠ ["]	⊠	EAN
12-655	1/4	0/36	5907558418019
12-656	3/8	0/36	5907558418026

Naolejacz

Oilier / Ölgerät / Смазьватель / Оливорозпилювач / Olajozó pneumatikus / Gresor de ulei / Mazací jednotka / Olejovač / Lubrikator / Teralinè / Ieeļotājs / Õlitusseade / Смазвач / Nauljivač / Podmazivač / Ψεκαστήρας λαδιού / Lubrificador / Oliatore per utensili pneumatici / Máquina oleadora / Huileur / Smeertoestel

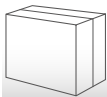

Ref.	⊠	EAN
14-552	1/200	5907558444902

Kompresor

Compressor / Kompresor / Компрессор / Компресор / Kompessor / Compresor / Kompresor / Kompresor / Kompresor / Kompresorius / Kompresors / Kompresor / Компресор / Kompresor / Kompresor / Συμπιεστής / Compresor / Compresore / Compresor / Compresseur / Compresor

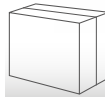

Ref.	⊠	EAN
12K020	0/1	5907558453676

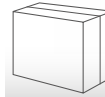

Ref.	⊠	EAN
12K021	0/1	5907558453683

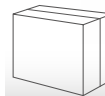

Ref.	⊠	EAN
12K022	0/1	5907558453690



Kompresor olejowy

Compressor - lubricated / Ölkompressor / Компрессор масляный / Компресор олійний / Kompreszor / Compresor cu ulei / Olejový kompresor / Kompresor / Oljni kompresor / Tepalínis kompresorius / Είλας kompresors / Kompresor (määritud) / Компресор / Kompresor / Kompresor / Συμπιεστής γρασαρισμένος / Compresor de aceite / Compresore ad olio / Compresor de óleo / Compresseur à huile / Olie compressor

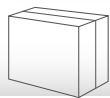

Ref.	☒	EAN
12K030	0/1	5907558453706

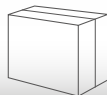

Ref.	☒	EAN
12K031	0/1	5907558453713

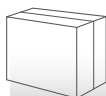

Ref.	☒	EAN
12K010	0/1	5907558439373

Pistolet do przedmuchiwania

Blowing gun / Pistole zum Durchblasen / Пистолет для продувания / Пістолет до продування / Pneumatikus lefúvatópisztoly / Pistole de baleiaj / Pistole pro profukování / Prefukovacia pištoľ / Izpihovalna pištoľa / Prapūtimo pistoletas / Caurpūšanas pistole / Lābiloputuspištoľ / Пистолет за продување / Pištoľ za ispuhvanje / Pištoľ za prodnavanje / Πιστόλι αέρος / Pistola de limpieza a chorro de aire / Pistola aria compressa / Pistola para soprar / Pistolet de soufflage / Afblaaspistol



Ref.	☒	EAN
14-036	10/20	5907558469035

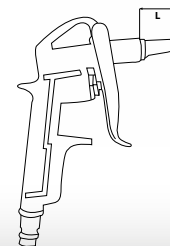

Ref.	L [mm]	☒	EAN
14-708	-	1/100	5907558452129
14-710	83	1/100	5907558452136
14-712	220	1/40	5907558452143

Pistolet natryskowy

Spray gun / Sprühpistole / Пистолет-распылитель / Фарбонпульт / Festékszóró pisztoly / Pistol de duș / Stříkací pistole / Striekacia pištoľ / Brizgalna pištoľa / Purškimo pistoletas / Pistole-smidzinātājs / Pihustuspüstol / Пистолет - наноузамор / Pištoľ za prskanje / Pištoľ za prskanje / Πιστόλι ψεκασμού / Pistola de aspersi3n / Pistola a spruzzo / Pistola de borfirar / Pistolet à projection / Spuitpistool



Zestaw lakierniczy

Lacquer set / Lackierset / Набор для лакирования / Комплект до лакофарбувальних робіт / Kompressor tartozékészlet / Garnitură de lacuit / Lakovací sada / Súprava na lakovanie / Komplet za lakiranje / Komplektas dažytojų / Laku komplekts / Lakkimiskomplekt / Комплект за лакиране / Set za lakiranje / Pribor za lakiranje / Σετ βερνικώματος / Juego de herramientas para barnizado / Pistola a spruzzo in kit / Kit p. Verniz / Jeu d'outils de peinture / Lakset

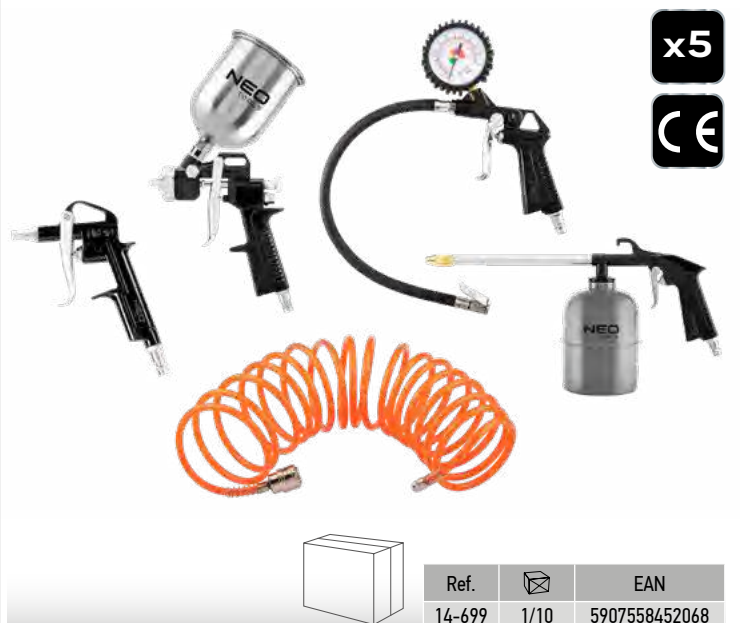

Pistolet do konserwacji

Maintenance gun / Wartungspistole / Αντιкоррозийный пистолет со шлангом / Фарбонпульт / Alfvázvédő szórópisztoly tömlővel / Pistol de conservare / Pistole pro údržbu / Konzervačná pištoľ / Pištoľ za nanašanje zaščite / Oro išsiurbimo pistoletas / Konservācijas pistole / Hoolduspistol / Пистолет за конзервация / Pištoľ za održavanje / Pištoľ za konzerviranje / Πιστόλι ψεκασμού για συντήρηση / Pistola de conservación / Pistola per rivestimenti / Pistola p. Conservação / Pistolet d'entretien / Onderhoudspistol



ALU BODY



Ref.	☒	EAN
14-720	1/20	5907558452181

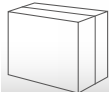

Pistolet do mycia

Washing gun / Reinigungspistole / Пистолет-распылитель для мытья / Пистолет для миття / Alfvázvédő szórópisztoly / Pistol de spălat / Pistole na mytí / Čistiaca pištoľ / Pištoľ za pranje / Plovimo pistoletas / Mazgāšanas pistole / Pesemispistol / Пистолет за миене / Pištoľ za pranje / Pištoľ za pranje / Πιστόλι πλύσης / Pistola de limpiar / Pistola per pulizia / Pistola p. Limpeza / Pistolet de lavage / Waspistol



215 mm

1L

2.5-4 BAR



Ref.	☒	EAN
14-706	1/20	5907558452112



Pistolet do piaskowania

Sandblasting gun / Pistole zum Sandstrahlen / Пескоструйный пистолет с бачком / Пистолет до піскоструменевої обробки / Homokfúvó pisztoly tartállyal / Pistol de sablare / Piskovací pistole / Pieskovacia pištoľ / Pištoľ za peskanje / Smėliavimo pistoletas / Smilšstrūklošanas pistole / Liivaprits / Пистолет за масно / Pištoľ za pjeskarenje / Pištoľ za peskarenje / Πιστόλι αμμοβολής / Pistolas de decapado por arena / Pistola per sabbatura / Pistola p. Areia / Pistolet à sablage / Zandblaaspistol



ALU BODY

1L



Ref.	☒	EAN
14-724	1/10	5907558452204



MAX 8 BAR

0.5-6.8 l/min

125 L/MIN

Ref.	☒	EAN
14-722	0/40	5907558452198

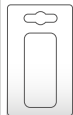

Pistolet do pompowania

Inflating gun / Pumpenpistole / Пистолет для подкачки шин / Пистолет до помпування / Kerékfúvató pisztoly nyomásmérővel / Pistol de pompare / umflare / Plnicí pistole / Pumpovacia pištoľ / Pištoľ za črpanje / Siurbimo pistoletas / Sūkņēšanas pistole / Pūstolpump / Пистолет за изпомпване / Pištoľ za pumpanje / Pištoľ za pumpanje / Πιστόλι φουσκώματος ελαστικών / Pistola para inflar / Gonfiatore per pneumatici / Pistola p. Bomba / Pistolet de pompage / Pomppistol



ALU BODY

370mm

max 12 BAR

63mm



Ref.	☒	EAN
14-714	1/40	5907558452150



ALU BODY

300mm

max 12 BAR



Ref.	☒	EAN
14-716	1/20	5907558452167

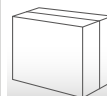

Pistolet do pompowania

Inflating gun / Pumpenpistole / Пистолет для подкачки шин / Пистолет до помпування / Kerékfűvató pisztoly nyomásmérővel / Pistol de pompare / umflare / Plnicí pistole / Pomrovacia pištoľ / Pištoľ za črpanje / Siurbimo pistoletas / Sūkņēšanas pistole / Püstoľpump / Пүстоľем за изпомпване / Pištoľ za pumpanje / Pištoľ za pumpanje / Πιστόλι φουσκώματος ελαστικών / Pistola para inflar / Gonfiatore per pneumatici / Pistola p. Bomba / Pistolet de pompage / Pomppistol



0-12
bar

80mm

max 12 BAR

440mm

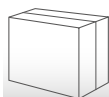

Ref.	☒	EAN
14-718	0/20	5907558452174

Wężyk do pompowania

Hose for inflating gun / Schlauch zum Pumpen / Шланг к пистолету / Шланг до пүстоľемү / Kerékfűvató tömlő / Furtun pentru pistol de pompare / Hadička na pumrování / Hadička na pumprovanie / Cev za črpanje / Žarnelē pumpravimui / Saurulīte sūkņēšanai / Pomvavoolitik / Маркуч за напомпване / Crijevo za pumpanje / Crevo za pumpanje / Εύκαμπτος σωλήνας πιστολιού / Manguera para bombear / Tubo di gonfiaggio / Mangueira p. bombas / Flexible de pompage / Pompslang



Ref.	L [mm]	☒	EAN
14-820	400	0/100	5907558452280





NARZĘDZIA I AKCESORIA MOTOCYKLOWE

motorcycle
tools and accessories

Інструменти та аксесуари
для мотоциклів

Pokrowiec oddychający na motocykl / skuter

Breathable motorcycle/scooter cover / Atmungsaktive Motorrad-/Rollerabdeckung / Дышащий чехол для мотоцикла/скутера / Дихающий чехол для мотоцикла/скутера / Lélegző motorkerékpár/robogó huzat / Acoperire respirabilă pentru motocicletă/scooter / Prodyšný obal na motocykl/skútr / Priedušný obal na motocykel/skúter / Dihajoča prevleka za motorno kolo/skuter / Kvepuojantis motociklo / motoralerio dangtis / Elpojošs motocikla/skūtera pārsegs / Дышащо покрывало за мотоциклет/скутер / Αναπνεύσιμο κάλυμμα μοτοσικλέτας/μυχανής / Copri moto/scooter traspirante / Cobertura respirável de motocicleta/scooter / Funda transpirable para moto/scooter / Housse de moto/scooter respirante / Ademende motorfiets-/scooterhoes



220x
105x
130 cm

waterproof
breathable

black
flat fabric

Ref.	☒	EAN
10-472	0/1	5907558471090

Pokrowiec na motocykl / skuter

Motorcycle / scooter cover / Motorrad-/Rollerabdeckung / Чохол для мотоцикла/скутера / Чехол для мотоцикла/скутера / Motorkerékpár/robogó védőhuzat / Husă pentru motocicletă/scooter / Potaħ na motorku/skútr / Potaħ na motorku/skúter / Prevleka za motorno kolo/skuter / Motociklo / motoralerio dangtis / Motocikla/skūtera pārsegs / Покривало за мотоциклет/скутер / Κάλυμμα μοτοσικλέτας/σκούτερ / Copertura per moto/scooter / Funda para moto/scooter / Housse de moto/scooter / Cobertura de motocicleta/scooter / Motorfiets-/scooterhoes



246
x104
x127cm

190 T
polyester
taffeta

waterproof
resistant
to UV 150°

Ref.	☒	EAN
10-473	0/1	5907558471106

Kuweta na narzędzia, silikonowa

Silicone screw cell small / Werkzeugablage, Silikon / Лоток для інструментів, силіконовий / Лоток для инструментов, силиконовый / Szerszámtálca, szilikon / Tavă pentru scule, silicon / Zásobník na nářadí, silikonový / Zásobník na nářadí, silikónový / Pladenj za orodje, silikon / Įrankių dėklas, silikoninis / Instrumentu paliktinis, silikona / Тава за инструменти, силикон / Δίσκος εργαλείων, σιλκόνή / Vaschetta per attrezzi, silicone / Bandeja de herramientas, silicona / Plateau à outils, en silicone / Bandeja de ferramentas, silicone / Gereedschapsbakje, silicone /



MADE OF
STRONG
TPR
SILICONE

Ref.	Info [mm]	☒	EAN
10-480	275 x 145 x 25	1/20	5907558471137
10-481	257 x 232 x 25	1/20	5907558471144
10-482	540 x 290 x 35	1/10	5907558471151

Mata środowiskowa

Environmental mat / Umweltmatte / экологический коврик / экологічний мат / Környezetvédelmi szőnyeg / Covorăș de mediu / Environmentální podložka / Environmentálna podložka / Okoljska podloga / Aplinkos kilimėlis / Vides paklājīņš / Keskkonna matt / Экологічна мат / Ekološki mat / Екологічна простурка / περιβαλλοντικό χαλάκι / Alfombra ambiental / Tappetino ambientale / Tapete ambiental / Tapis environnemental / Milieumat



100 x
200
cm

HYDROPHOBIC
INTERNAL
SURFACE

PET
+
PVC

4.9
kg

Ref.	☒	EAN
10-600		5907558499865



Zestaw narzędzi

Tool and socket set / Werkzeugsatz / Набор инструментов / Инструмент з насадками, набір / Szerszámkészlet / Set scule de grădină / Sada nářadí / Súprava náradia kombi / Garnitura orodij / Įrankių komplektas / Instrumentu komplekts / Tööriistade ja padrunite komplekt / Комплект инструментов / Set alata / Gedora set / Συλλογή εργαλείων / Juego de herramientas / Set di attrezzi / Kit de ferramentas / Jeu d'outils / Gereedschapset

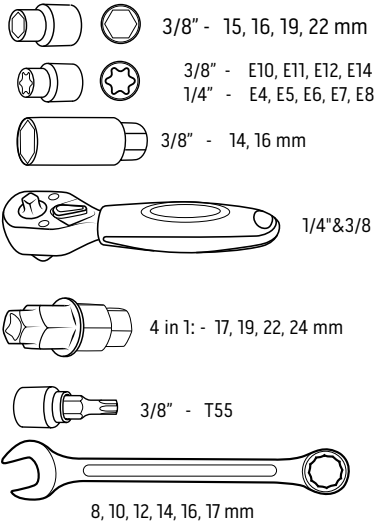

CrV
steel
x25
1/4"
3/8"

Ref.	📦	EAN
10-500	1/10	5907558466317

Narzędzie do osi motocyklowych

Motorcycle axle tool / Werkzeug für Motorrad-Achsen / Инструмент для оси мотоцикла / Инструмент для осей мотоцикла / Szerszám motorkerékpár tengelyekhez / Cheie hexagonală ax roata motocicletă / Přípravek na osy motocyklů / Náradie na motocyklové osi / Orodje za osi motociklov / Motociklo ašij įrankis / Motocikla ass rīki trīs vienā / Mootorratta-teljetoõriistad / Инструмент за мотоциклетни осу / Alat za osovine motocikla / Alat za osovine motocikla / Herramienta de eje de motocicleta / Utensile per assi delle moto / Ferramenta para eixos de motocicleta / Outil pour axe de moteur / As Inbus Zeskant voor motorfietsen

6in1



CrV steel
 12mm FOR: KTM Front axis
 19mm FOR: YAMAHA
 17mm FOR: BENELLI
 22mm FOR: KAWASAKI
 14mm FOR: YAMAHA XT660Z KAWASAKI ER-5N VERSYS XT660Z
 24mm FOR: BMW HONDA SUZUKI

Ref.	📦	EAN
10-501	1/72	5907558466324

4in1



CrV steel
 17mm 19mm
 22mm 24mm

Ref.	📦	EAN
10-502	1/72	5907558466331

3in1



carbon steel
 19mm
 22mm 24mm

Ref.	📦	EAN
10-503	1/72	5907558466348

Wskaźnik zegarowy GMP

GMP dial indicator / GMP-Uhranzeige / Индикатор часов GMP / Годинникової індикатор GMP / GMP órás indikátor / Indicator cadran GMP / Úchylkoměr pro nastavení předstihu / Hodinový ukazovateľ GMP / Merilna ura GMP / Laikrodinis viršutinio mirties taško indikatorius / GMP pulksteņa indikators / GMP-numbrināidīk / GMP часовников индикатор / Satni indikator GMP / Satni indikator GMP / Indicador de dial GMP / Comparatore GMP / Relógio comparador GMP / Indicateur à cadran GMP / GMP wijzerplaat indicator

CrV
steel



Ref.	📦	EAN
10-504	1/10	5907558466355

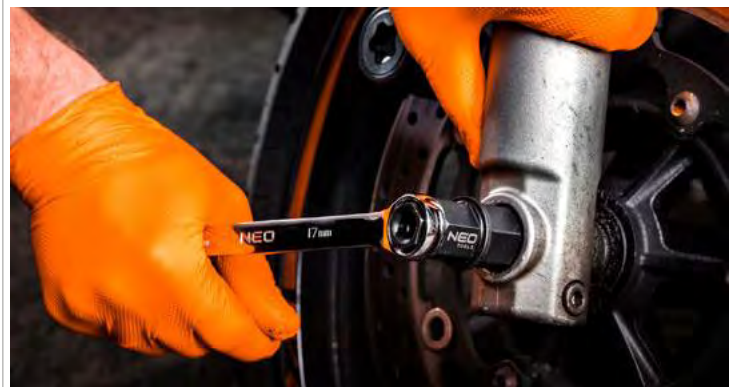

Zestaw narzędzi do zakuwania i rozkuwania łańcucha

Chain crimping and uncrimping set / Set zum Crimpen und Entcrimpen von Ketten / Набор для обжима и разжима цепи / Набор для обжиму та розжиму ланцюга / Láncfűző és -bontó készlet / Set de sertizare și degajare a lanțului / Sada na krimpování a rozplétání řetězů / Súprava na krimpovanie a odskrutkovanie reťaze / Komplet za stiskanje in odpenjanje verige / Grandinių užspaudimo ir atspaudimo rinkinys / Kėdes presėšanas un atpresėšanas komplekts / Tööriistade komplekt keti kokkukpressimiseks ja katkestamiseks / Комплект за пресовање и разпресовање на верицу / Set alata za presovanje i lomljenje lanca / Set alata za presovanje i lomljenje lanca / Set di crimpaggio e disincastro per catene / Conjunto de engaste e desengastamento de correntes / Kit de sertissage et de dessertissage de chaîne / Kettingkrimp- en ontcrimpset



INCLUDES PINS SIZES:
3, 4, 5 mm

FOR CHAIN SIZES:
520, 525
530, 532

Ref.	📦	EAN
10-505	1/10	5907558466362

Zestaw narzędzi do cylinderków hamulcowych

Tool set for brake cylinders / Werkzeugsatz für Bremszylinder / Набор инструментов для тормозных цилиндров / Набор інструментів для гальмівних циліндрів / Szerszámkészlet fékhengerekhez / Set de unelte pentru cilindri de frână / Sada nářadí na brzdové válce / Súprava nástrojov na brzdové valce / Komplet orodja za zavorne cilindre / Stabdžij cilindru įrankių rinkinys / Instrumentu komplekts bremžu cilindriem / Tööriistakomplekt pidurisilindrite jaoks / Комплект інструменту за спирачни циліндри / Set alata za kočione cilindre / Komplet alata za kočione cilindre / Juego de herramientas para cilindros de freno / Set di attrezzi per cilindri dei freni / Conjunto de ferramentas para cilindros de travão / Jeu d'outils pour cylindres de frein / Gereedschapsset voor remcilindersicator



12 adapters

Ø 19-30 mm

Ref.	📦	EAN
10-506	1/5	5907558466379

Narzędzie do rozkuwania łańcucha

Motorcycle chain cutter / Motorrad-Kettenschneider / Мотоциклетная цепь / Розрізувач ланцюга мотоцикла / Motorkerékprár láncvágó / Mašina de tăiat lanțuri de motocicletă / Motocyklový řezák řetězů / Reťazový rezač na motocykel / Rezalnik verige motornega kolesa / Motociklo grandinės pjoviklis / Motocikla kėdes griezėjis / Mootorratta ketilõikur / Резек за мотоциклетна верица / Rezač lanca motocikla / Резач ланца мотоцикла / Κόφτης αλυσίδας μοτοσικλέτας / Cortacadenas para motos / Tagliacatena per moto / Corrente de motocicleta cutter / Coupe-chaîne de moto / Kettingnijder voor motorfietsen



FOR CHAIN SIZES:
415, 420
423, 428

Ref.	📦	EAN
10-510	1/50	5907558466416

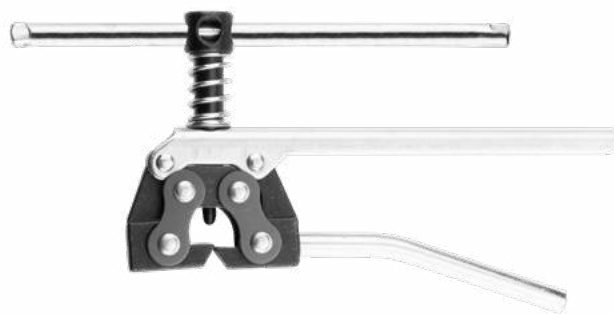

FOR CHAIN SIZES:
520, 525
530, 532

Ref.	📦	EAN
10-511	1/30	5907558466423

Nylonowa szczotka do czyszczenia łańcucha

Chain cleaning nylon brush / Nylon-Bürste für die Reinigung der Kette / Нейлоновая щетка для очистки цепи / Нейлонова щітка для чищення ланцюга / Nylon lánc tisztító kefe / Perie de nylon de curățat lanțuri / Nylonový kartáč na čistení řetězů / Nylónová kefa na čistenie reťaze / Najlonska krtača za čiščenje verige / Nailoninis grandinės valdymo šepetys / Neilona birste kėdes tirišanai / Nailonist ketipuhastushari / Нейлонова четка за почистване на верица / Najlonska četka za čiščenje lanca / Βούρτσα καθαρισμού αλυσίδας από νάylon / Cepillo de nylon para limpiar cadenas / Spazzola in nylon per la pulizia di catene / Escova de nylon para limpeza de correntes / Brosse pour chaîne en nylon / Nylonborstel voor het reinigen van kettingen



CHAIN CLEANING

NYLON BRISTLES

UTYPE



Ref.	📦	EAN
10-509	1/100	5907558466409

Szczypce do wyciągania tłoczków hamulcowych

Brake piston retractors / Zange für das Herausnehmen der Bremskolben / Съемник для тормозных цилиндров / Плоскозубці для зняття гальмівних поршнів / Fékdugattyúk kihúzására szolgáló fogó / Clește pentru extragerea pistoanelor de frână / Kleště na vytažení brzdových pístů / Klešte na vytahovanie brzdových piestov / Klešče za odstranjevanje zavornih batnic / Stabdžij stūmokliju traukimo žnyplės / Knaibles bremžu virzļu noņemšanai / Pidurikalbide eemaldamise tangid / Клеци за изваждане на спирачни бутала / Klijesta za skidanja klipova kočnica / Klešta za skidanje klipova kočnica / Πένσα ανοίγματος εμβόλων φρένων / Pinzas para retirar pistones de freno / Pinze per l'estrazione dei pistoncini dei freni / Alicata de remoção do pistão do travão / Pinceaux pour retirer les pistons de freins / Remzuiger-demontagetang



CrV steel

Ø 16.5mm -38mm

Ref.	📦	EAN
10-507	1/20	5907558466386



Zestaw kluczy do szprych motocyklowych

Motorcycle spoke wrench set / Motorrad-Speichenschlüsselsatz / Набор гаечных ключей для мотоциклетных спиц / Набор гайкових ключів для мотоциклів / Motorkerékprár küllőkulcskészlet / Set de chei pentru gaze de motocicletă / Sada klíčů na motocyklové paprsky / Sada klíčův na špiče motocyklů / Garnitura ključev za kolesa z papirami za motorna kolesa / Motociklo veržirakčij rinkinys / Motociklu spieķu atslēgu komplekts / Mootorratta mutrivõtmete komplekt / Комплект ключевое за спици на мотоциклет / Set ključeva za žbice motocikla / Комплект ключев за мотоцикле / Σετ κλειδιών ακτινών μοτοσυκλέτας / Juego de llaves de radios de moto / Set di chiavi a raggi per moto / Conjunto de chaves de boca de moto / Jeu de clés à rayons pour motos / Motorfiets spaaksleutelset

9 psc 5.4 mm 5.6 mm 5.8 mm 6.0 mm 6.2 mm



Ref.	☒	EAN
10-508	1/60	5907558466393

Nasadka nakrętki zawieszenia - Suzuki

Suzuki suspension nut socket / Aufsatz für Aufhängung-Mutter - Suzuki / Крышка гайки для подвески - Suzuki / Насадка гайки підвіски - Suzuki / Dugókulcs felfüggesztés anyához - Suzuki / Capac piuliftā suspensie - Suzuki / Násadka matice odpružení - Suzuki / Nadstavec matice zavesenia - Suzuki / Nastavek za matico vzmetelja - Suzuki / Pakabos veržės dangtelis - Suzuki / Piekares uzgriežņa uzgalis - Suzuki / Vedrustusmutri kork - Suzuki / Накладка на гайката на окачването - Suzuki / Kapa navrtke ovjesa - Suzuki / Profil navrtke trapa - Suzuki / x / Tapa de la tuerca de suspensión - Suzuki / Bussola per dado della sospensione - Suzuki / Tampa da porca de suspensão - Suzuki / Douille de l'écrou de suspension - Suzuki / Kap voor ophangingsmoer - Suzuki



DESIGNATED FOR: SUZUKI 4mm 5mm 8mm

Ref.	☒	EAN
10-585	1/60	5907558466935

Zestaw narzędzi do łożysk kół do Harley'a-Davidsona

Harley-Davidson wheel bearing tool kit / Radlager-Werkzeugsatz für Harley-Davidson / Набор колесных подшипников для Harley-Davidson / Набор інструментів для підшипників коліс Harley-Davidson / Kerécsapágy szerszámkészlet Harley-Davidsonhoz / Set de scule pentru rulmenți de roți pentru Harley-Davidson / Sada nástrojů na ložiska kol pro Harley-Davidson / Súprava náradia na ložiská kolies Harley-Davidson / Set orodij za ležaje za kolesa Harley-Davidson / Įrankių rinkinys „Harley-Davidson“ ratų guoliams / Harley-Davidson riteņu gultņu instrumentu komplekts / Harley-Davidsoni rattalaagrite tööriistade komplekt / Комплект инструменти за лагери на колелата за Harley-Davidson / Set alata za ležajeve kotača za Harley-Davidson / Set alata za ležajeve točkova Harley Davidson / Σετ εργαλείων ρουλεμάν τροχών για Harley-Davidson / Kit de herramientas para rodamientos de ruedas de Harley-Davidson / Kit di attrezzi per cuscinetti delle ruote per Harley-Davidson / Kit de ferramentas para rolamentos de rodas de Harley-Davidson / Ensemble d'outils pour paliers des roues Harley-Davidsona / Gereedschapssset voor wiellagers van Harley-Davidsons



Ref.	☒	EAN
10-586	1/2	5907558466942

Klucz hakowy

Hook wrench / Rohrzange / Ключ трубный / Ключ для круглых шлицевых гаек / Unverzális csőfogó / Cheie secera / Hákový kľúč / Hákový kľúč / Kjúkasti kľuč / Raktas- kablys / Ακνεida uzgriežņa atslēga / Haakvõti / Ключ за за кръгли шлицови гайки / Kukasti kľuč / Kukasti kľuč / Γαλλικό κλειδί / Llave de gancho / Chiave a gancio / Chave de gancho / Clé à crochet / Haaksleutel



Ref.	Info []	☒	EAN
10-569	16-20	1/100	5907558466775
10-570	25-28	1/50	5907558466782
10-571	30-32	1/50	5907558466799
10-572	34-36	1/50	5907558466805
10-573	40-42	1/50	5907558466812
10-574	45-50	1/50	5907558466829
10-575	52-55	1/50	5907558466836
10-576	58-62	1/25	5907558466843
10-577	68-75	1/25	5907558466850
10-578	80-90	1/15	5907558466867
10-579	95-100	1/15	5907558466874
10-580	110-115	1/10	5907558466881
10-581	120-130	1/10	5907558466898
10-582	135-145	1/20	5907558466904
10-583	155-165	1/20	5907558466911

Ściągacze do kół zamachowych

Flywheel pullers / Schwungradabzieher / Съемники маховиков / Знімачі маховиц / Húzószerszámok lendkerékhez / Extractoare de volante / Stahováky setvačnicků / Stáhovač na zotrvačníky / Orodje za snemanje vztrajnika / Smagracių nuėmikliai / Hooraratta tömmitsad / Hoararatta savilceji / Hoararatta tömmitsad / Издървачи за маховици / Izvlekači za zamašnjak/zvlekači zamajca / Εξολκείς βολάν / Extractor de volante de inercia / Estrattori a volano / Extratores de volante / Outils pour enlever la roue d'inertie / Vliegwieltrekkers

Right threads: M14 x P1,5;
M16 x P1,5; M18 x P1,5;
M19 x P1,0;
M20 x P1,0; M22 x P1,0;
M22 x P1,5; M24 x P1,0;
M25 x P1,5;
M26 x P1,0; M26 x P1,5;
M28 x P1,0; M27 x P1,25;
M28 x P1,5;
Left threads - M27 x P1,0



Ref.	☒	EAN
10-584	1/5	5907558466928

Blokada kosza sprzęgła

Clutch cage retainer / Kupplungskorbsschloss / Ключ-блокировка корзины сцепления / Фиксація ношика зчеплення / Kuplungkosár-zár / Blocare coș ambreiaj / Kľuč na spojkový koš / Blokada koša spojky / Blokada koša / Sankabos dėžės užraktas / Sąjūga graza slėdzene / Sidurikorvi lukk / Замкюване на ноша на съединителя / Blokada košarice kvačila / Blokada košarice kvačila / Εργαλείο συγκράτησης καμπάνας συμπλέκτη / Bloqueo de la jaula del embrague / Blocco cestello fizione / Bloqueio do cesto de embraiagem / Outil de verrouillage du panier d'embrayage / Koppelingsmandblokkade

CrV steel + TRAVEL CASE DESIGNATED FOR: HARLEY DAVIDSON 3/4" - 1" 2000-2006 MODELS 25mm 2007-2008 MODELS 4850-485



Ref.	☒	EAN
10-587	1/20	5907558466959

Zestaw narzędzi do montażu i demontażu łożysk główki ramy w motocyklach

Motorbike head frame bearing installation and removal tool kit / Werkzeugsatz für die Montage und Demontage von Motorradkopflagern / Набор инструментов для установки и снятия подшипников головной рамы мотоцикла / Набор інструментів для встановлення та зняття підшипника головної рами мотоцикла / Motorkerékpár fejcsapágy szerelési és eltávolítási szerszámkészlet / Kit de instrumente de instalare și demontare a rulmenților pentru montarea și demontarea cadrului capului motocicletei / Sada nástrojů pro montáž a demontáž ložisek rámu hlavy motocyklu / Súprava nástrojov na montáž a demontáž ložiska rámu hlavy motocykla / Komplet orodij za namestitve in odstranitev ležaja okvirja glave motornega kolesa / Motociklo galvos rėmo guolių montavimo ir nuėmimo įrankių rinkinys / Motocikla galvas rāmja gultņu uzstādīšanas un noņemšanas instrumentu komplekts / Tööriistade komplekt mootorrattaste roolipea laagrite paigaldamiseks ja eemaldamiseks / Комплект инструментов за монтаж и демонтаж на лагер на рамата на мотоциклета / Set alata za montažu i skidanje ležajeva glave upravljača na motociklima / Сет алата за уградњу и уклањање лежајева главе управљача на мотоциклима / Kit εργαλείων εγκατάστασης και αφαίρεσης ρουλεμάν πλαίσιοι κεφαλής μοτοσικλέτας / Kit de herramientas para la instalación y el desmontaje de los rodamientos del cuadro de la moto / Kit di strumenti per l'installazione e la rimozione dei cuscinetti del telaio della moto / Kit de ferramentas de instalação e remoção de apoios de cabeça de motocicleta / Kit d'outils de montage et de démontage des roulements du cadre de la tête de la moto / Motorfiets hoofdframe lager installatie en verwijdering gereedschapsset



TYPE
T
HANDLE

7
psc
adapters

DIAMETER
SIZES:
32-46
mm

Ref.	📦	EAN
10-588	1/2	5907558466966

Wyważarka statyczna do kół motocyklowych

Static motorcycle wheel balancer / Statische Motorrad-Radauswuchtmaschine / Статическіў балансувальнік колес мотоцикла / Балансир статичний для коліс мотоцикла / Statikus motorkerékpár kerékkiegyensúlyozó eszköz / Echilibrator de roți statice pentru motociclete / Statická vyvažovačka kol motocyklu / Statická vyvažovačka kolies motocykla / Statična izravnalna naprava za kolesa motornih koles / Statinis motociklo ratų balansavimo įtaisas / Statiskais motocikla riteņu balansieris / Staatiline tasakaalustaja mootorrattaste jaoks / Статичен балансир за колела на мотоциклет / Statički uređaj za balansiranje kotača motocikla / Статички баланс точкова за точкове мотоцикала / Στατική εξισορρόπηση για τροχούς μοτοσικλετών / Equilibrador estático de ruedas de moto / Equilibratore statico della ruota della moto / Roda de motocicleta estática balancer / Équilibreur statique de roue de motocyclette / Statische motorfiets wiel balancer



max
21"

14-28
mm
AXIS

39
kg

Ref.	📦	EAN
10-590	0/1	5907558466980

Mobilny podnośnik hydrauliczny do quadów i motocykli

Mobile hydraulic jack for quads and motorbikes / Mobilier hydraulischer Wagenheber für Quads und Motorräder / Мобильный гидравлический домкрат для квадроциклов и мотоциклов / Мобільний гідролічний домкрат для квадроциклів та мотоциклів / Mobil hidraulikus emelő quadokhoz és motorkerékrákokhoz / Cric hidraulic mobil pentru quad-uri și motociclete / Mobilni hidraulický zvedák pro čtyřkolky a motocykly / Mobilný hydraulický zdvihač pre štvorkolky a motocykle / Mobilni hidravlični dvigalo za štirikolesnike in motorna kolesa / Mobilus hidraulinis keltuvas keturračiams ir motociklams / Mobilais hidrauliskais domkrats kvadracikliem un motocikliem / Mobilne hidrauliline tungraud nelikutele ja mootorrattastele / Мобилен хидравличен повдигаач за четурколки и мотоциклети / Mobilna hidraulička dizalica za quadove i motocikle / Мобилна хидраулична дизалица за квад и мотоцикле / Κινητός υδραυλικός γρύλος για quads και μοτοσικλέτες / Gato hidráulico móvil para quads y motos / Martinetto idraulico mobile per quad e moto / Macaco hidráulico móvel para quads e motocicletas / Cric hydraulique mobile pour quads et motos / Mobiele hydraulische krik voor quads en motoren

up to
680kg

27
kg

MAX
375
mm
MIN
115
mm
H



Ref.	📦	EAN
10-596	0/1	5907558467048

Stojak motocyklowy pod przednie koło

Motorcycle front wheel stand / Vorderradständer für Motorräder / Стойка переднего колеса мотоцикла / Підставка для передніх коліс мотоцикла / Motorkerékpár első kerékállvány / Suport pentru roata din față a motocicletei / Stojan na přední kolo motocyklu / Stojan na predné koleso motocykla / Stojalo za sprednje kolo motornega kolesa / Priekinis motociklo ratų stovas / Motocikla priekšējo riteņu statīvs / Mootorratta esiratta stativ / Предна стойка за колело на мотоциклет / Stalak za motocikl ispod prednjeg kotača / Сталак за мотоцикле испод предњег точна / Στήριγμα μπροστινού τροχού μοτοσικλέτας / Caballete de rueda delantera de moto / Cavalletto anteriore per moto / Suporte da roda dianteira da motocicleta / Béquille de roue avant de motocyclette / Motorfiets voorwielstandaard

up to
680kg

19"
7-13cm



Ref.	📦	EAN
10-602	0/1	5907558467109



Przyrząd do demontażu i montażu kół motocyklowych

Tool for dismounting and mounting motorbike wheels / Werkzeug für die Demontage und Montage von Motorradrädern / Инструмент для демонтажа и монтажа колес мотоцикла / Инструмент для демонтажу і монтажу мотоциклетних коліс / Szerszám motorkerékpár kerekek le- és felszereléséhez / Urealtă pentru demontarea și montarea roților de motocicletă / Nástroj na demontáž a montáž kol motocyklu / Nástroj na demontáž a montáž kolies motocykla / Orodje za demontažo in montažo koles motornega kolesa / Įrankis motociklo ratams išmontuoti ir sumontuoti / Instruments motociklu riteņu demontāžai un montāžai / Tööriist mootorratta rataste lahtivõtmiseks ja kokkupanemiseks / Инструмент за демонтиране и монтиране на колела на мотоциклету / Alat za demontažu i montažu kotača motocikla / Алат за демонтажу и монтажу точкова мотоцикла / Εργαλείο για την αποσυναρμολόγηση και τοποθέτηση τροχών μοτοσικλέτας / Herramienta para desmontar y montar las ruedas de la moto / Attrezzo per smontare e montare le ruote della moto / Ferramenta para desmontagem e montagem de rodas de motos / Outil pour le démontage et le montage des roues de motos / Gereedschap voor het demonteren en monteren van motorfietswielen



12"-20"



Ref.		EAN
10-606	0/1	5907558467147





OŚWIETLENIE

workshop lighting освітлення

Latarka

Torch / Taschenlampe / Фонарик / Ліхтарик / Aluminium 2az1-ben zseblámpa/vizsgáológámpa / Lanterna / Bateria / Lampa / Svetilka / Žibintuvėlis / Lukturis / Pöleti / Фенерче / Baterijska / lampa / Lampa / Φακός / Linterna de mano / Torcia / Lanterna / Torche / Zaklamp



3W
300 max lm

CREE XPE+COB LED
ALUMINIUM BODY
BATTERY Li-Ion 3.7V 2000mAh
3h charging
POCKET CLIP
small size EDC compatible
ROTATING
USB charging
MAGNETIC

Ref. 99-034 50/100 EAN 5907558451443

1st click: 3% max 60 h

1st click: 10% max 10 h

1st click: 40% max 3 h

4th click: OFF
press 2 seconds: 100% max 45 sec.

double click: STROBE

30W 3300 max lm
BATTERY Li-Ion 3.7V 4000mAh
OSRAM P9 LED
220 m
ALUMINIUM BODY
USB charging cable
6h charging
IPX4



Ref. 99-037 20/40 EAN 5907558451474

1st click: 100% max 5 h

2nd click: 50% max 10 h

3rd click: SIDE 100% max 5 h

4th click: SIDE STROBE

5th click: OFF

10W 800 max lm
BATTERY Li-Ion 3.7V 2000mAh
CREE T6+COB LED
USB charging cable
ALUMINIUM BODY
2in1
150 m
5h charging
IP20
small size EDC compatible



Ref. 99-033 0/50 EAN 5907558451436

1st click: 100% min 3 h

1st click: 40% max 7 h

2nd click: 10% max 25 h

2nd click: OFF

click + hold: STROBE

10W 1000 max lm
250 m
ZOOM
BATTERY Li-Ion 3.7V 2200mAh
OSRAM P9 LED
BATTERY INDICATOR
USB charging cable
ALUMINIUM BODY
4.5h charging



Ref. 99-035 20/40 EAN 5907558451450

1st click: 100%

2nd click: OFF

3rd click: 20%

4th click: OFF

5th click: SOS strobe

light press: cycle modes

20W 1500 max lm
ALUMINIUM BODY
ZOOM
250 m
X6 AA
CREE XHP50.2 LED
3h work time
IPX4



Ref. 99-036 4/24 EAN 5907558451467

100% 200lm 2h

50% 100lm 5h

stroboscope

3W max 200lm
ZOOM
CREE XP-E2
waterproof IPX7 30min
x3 AAA
ALUMINIUM BODY





Ref. 99-101 12/72 EAN 5907558425482



Latarka

Torch / Taschenlampe / Фонарик / Лихтарик / Aluminium 2az1-ben zseblámpa/vizsgálólámpa / Lanterna / Bateria / Lampa / Svetilka / Žibintuvelis / Lukturis / Pöleti / Фенерче / Bateriajska / lampa / Lampa / Факός / Linterna de mano / Torcia / Lanterna / Torche / Zaklamp



10W	950 m	ANODIZED FINISH
500lm	OSRAM LED	BATTERY Li-Ion 3.7V 4000mAh
	4h charging	3h working
	USB C + cable	62.5x200 mm
		IPX4

Ref.	📦	EAN
99-070	4/24	5907558464948



10w	SST20 LED	100 m	WORKING TIME 3h 130..
500LM	CHARGING TIME 3h	3.7V 800mAh Li-Ion	cable included USB C
	WORKING TIME 2h 500..	BATTERY INDICATOR	EDC
		ALUMINIUM BODY	IPX4

Ref.	📦	EAN
99-074	10/40	5907558464986



10W	200 m	CHARGING TIME 4h	3.7V 4000mAh Li-Ion	BATTERY INDICATOR	cable included USB C
1500LM	SST40 LED	WORKING TIME 2.5h 1500..	WORKING TIME 3h 900..	WORKING TIME 7h 350..	WORKING TIME 9h 200..
				POCKET CLIP	ALUMINIUM BODY
					IPX4

Ref.	📦	EAN
99-075	10/40	5907558464993



20W	180 m	CHN LED	CAPACITY & CHARGING INDICATOR
2000lm	4h charging	ALUMINIUM BODY	USB C + cable
		ANDODIZED FINISH	IPX6
			POCKET CLIP

Ref.	📦	EAN
99-067	6/48	5907558464917



4W	COB LED	400 max lm
	x3 AA INCLUDED	POCKET CLIP

1st click: 50%
2nd click: 100%
3rd click: RED STROBE

Ref.	📦	EAN
99-045	50/100	5907558452365



3W	200 max lm	ALUMINIUM BODY
		COB LED
		x3 AA
		IP20

Ref.	📦	EAN
99-032	0/75	5907558451306



100 lm	OSRAM P9 LED	small size EDC compatible
	1h worktime	35 m
	x1 AAA NOT INCLUDED	ALUMINIUM BODY
		ANDODIZED FINISH
	HEAD ROTATE on/off	9g
		IPX4

Ref.	📦	EAN
99-068	20/200	5907558464924



3W	2in1	4 LIGHT FUNCTIONS	COB LED	LASER	cable included USB
90LM	CHARGING TIME 30min	WORKING TIME 40min	3.7V 120mAh Li-Pol	RED LIGHT MODE	ABS BODY
				32.5mm x 32mm x 18mm	14g
					IPX4

Ref.	📦	EAN
99-078	10/80	5907558465709



Latarka czółowa

Headlamp / Stirnlampe / Фонарь налобный / Ліхтарик на чільний / Fejlámpa / Lampă cap / Čelní baterka / Lampo čelová / Čelna svetilka / Žibintuvelis / Lukturītis uz pieres / Esilatern / Лампа за главо / Lampo za glavu / Rucna lampo / Φακός κεφαλής / Linterna de frente / Lampadina frontale / Lanterna de testa / Torche frontale / Hoofzaklamp



- 1st click: 40% max 2 h
 2nd click: 10% max 6 h
 3rd click: OFF
- press 2 seconds: 100% max 40 sec.
 double click: STROBE

Ref.	⊠	EAN
99-027	10/80	5907558451252

- 1st click: 70% max 4 h
 2nd click: 45% max 4 h
 3rd click: 12% max 6 h

long press: OFF
 press fast 2 times:

- 100% max 2.5 h
 + click 1: STROBE
 + click 2: SOS
 long press: OFF
 press 2 seconds: Red
 + click 1: STROBE
 + click 2: Blue
 long press: OFF



Ref.	⊠	EAN
99-028	0/50	5907558451269

- 1st click: 100% max 1.5 h
 2nd click: 50% max 3 h
 3rd click: STROBE
 4th click: OFF



Ref.	⊠	EAN
99-026	56/112	5907558451245

- 1st click: 40% max 5 h
 2nd click: 15% max 9 h
 3rd click: 3% max 60 h
 4th click: OFF
 press 2 seconds: 100% max 40 sec.
 double click: STROBE



Ref.	⊠	EAN
99-029	10/40	5907558451276

- 1st click: 100%
 2nd click: 40%
 3rd click: RED
 4th click: RED strobe
 long press: MOTION SENSOR



Ref.	⊠	EAN
99-069	6/48	5907558464931



Ref.	⊠	EAN
99-073	25/50	5907558464979



Latarka czółowa

Headlamp / Stirnlampe / Фонарь налобный / Ліхтарик на чільний / Fejlámpa / Lampă cap / Čelní baterka / Lampa čelová / Čelna svetilka / Žibintuvelis / Lukturītis uz pieres / Eslatarn / Лампа за главо / Lampa za glavu / Rucna lampa / Φακός κεφαλής / Linterna de frente / Lampadina frontale / Lanterna de testa / Torche frontale / Hoofdzaklamp

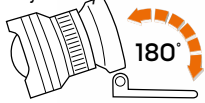

100% 400lm

2h

50% 200lm

5h

stroboscope



5W
max
400lm



CREE
R5

x3
AAA

Ref.	⊠	EAN
99-200	10/40	5907558425505

100% 250lm

3h

50% 125lm

5h

stroboscope



3W
max
250lm



CREE
XPE

x3
AAA

Ref.	⊠	EAN
99-201	0/40	5907558425710

350LM	XPE+ COB LED	MOTION SENSOR	1200mAh Li-Ion	5 LIGHT FUNCTIONS	RUBBER BODY
WORKING TIME 3-6,5h	CHARGING TIME 2.5h	cable included	USB C	67g	IPX4



Ref.	⊠	EAN
99-097		5907558493702



Lampa warsztatowa

Workshop lamp / Werkstattlampe / Лампа переносная / Лампа переносна / Steklámpa / Lampă atelier / Dlienská lampa / Dielenská lampa / Delavniška svetilka / Lampa dirbtuvems / Pārnesājamā lampa / Töökoja lampa / Lampa работна / Radna lampa / Radna lampa / Λάμπα εργαστηρίου / Lámpara de taller / Lampada da officina / Lâmpada de oficina / Lampe d'atelier / Werkplaatlamp

1st click:
100%
max 1.5 h

2nd click:
50%
max 3 h

3rd click:
100%
max 3 h

4th click: OFF

press 2 seconds:
RED LIGHT
max 3 h

+ click 1:
RED STROBE

+ click 2: OFF

3W
200
max lm

COB LED

2in1
LAMP + TORCH



BATTERY
Li-Ion
3.7 V
1200mAh

FOLDING

4h
charging

IP20

USB
charger
+ cable



Ref.	⊠	EAN
99-041	0/50	5907558452327

1st click:

100%
max 2h

2nd click:

30%
max 7h

3rd click:
OFF

8W
600
max lm



BATTERY
Li-Ion
3.7 V
2200mAh

ABS



600
lm



IMPACT
RATING
IK08

10W
900
max lm

SMD LED

25000h
work time

ABS

363x
50x50
mm

CRI
Ra>80

H05RN-F2
x1.0mm²

6500
K

IP54

LEDs
x24

IMPACT
RATING
IK08

CABLE
5m
EU socket

230V
50Hz



Ref.	⊠	EAN
99-043	0/24	5907558452341
99-044	0/16	5907558452358

1st click:
max 3.5 h

2nd click: OFF

3rd click:
max 6 h

4th click: OFF

300
lm

2in1
LAMP + TORCH

COB LED

x3
AAA
INCLUDED



ABS

360°

ADJUSTABLE
STAND



Ref.	⊠	EAN
99-042	0/24	5907558452334



Lampa warsztatowa

Workshop lamp / Werkstattlampe / Лампа переносная / Лампа переносна / Steklámpa / Lampă atelier / Dílenská lampa / Dielenská lampa / Delavníška svetilka / Lampa dirbtuvėms / Pārnēsājamā lampa / Töökoja lamp / Лампа работна / Radna lampa / Radna lampa / Λάμπα εργατρίου / Lámpara de taller / Lampada da officina / Lämpäde de oficina / Lampe d'établi / Werkplaatlamp



2x350 lm
700 max lm
2x 4.5W
4000 K
2x BATTERY Li-ion 3.7 V 2200mAh
SMD LED
2h work time
2h charging
CHARGER INCLUDED
x6

Ref.	⊠	EAN
99-047	0/8	5907558452389



10W
1000 max lm
BATTERY Li-ion 3.7 V 4000mAh
SMD LED
3.5h work time
4.5h charging
CHARGER INCLUDED
x4

1st click:
100% max 3.5 h

2nd click:
50% max 6 h

press 2 seconds:
FLASHING

FOLDABLE HOOKS with magnets
ADJUSTABLE HOLDERS 130 - 200 cm

Ref.	⊠	EAN
99-048	1/4	5907558452396



5W+1W
500 lm
CHARGER INCLUDED
2in1 lamp torch
DIMMING
COB LED
CAPACITY INDICATION
BATTERY Li-ion 3.7 V 2600mAh
HOOK
MAGNETIC
3.5h charging
2-2.5h working
ABS BODY 270x90x80 mm
USB C charger + cable
IP20

Ref.	⊠	EAN
99-065	0/20	5907558464894



6W
500lm
BATTERY Li-ion 3.7 V 2400mAh
COB LED
HOOK
FOLDING CONSTRUCTION
3-4h charging
ABS BODY max 4h (50%) working
400x65x52 mm
IP20

Ref.	⊠	EAN
99-066	0/20	5907558464900



10+5 W W
550+150 LM
2in1 LAMP + TORCH
COB LED
CHARGER INCLUDED
cable included USB C
DIMMING
RED LIGHT MODE
360°
CHARGING TIME 3h
WORKING TIME 3h 3.5h LAMP TORCH
3.7V 2000mAh Li-ion
BATTERY INDICATOR
HANGING HOOK x2
IP20

Ref.	⊠	EAN
99-071	10/20	5907558464955



10+3 W W
500+150 LM
2in1 LAMP + TORCH
COB LED
POWERBANK
cable included USB
RED LIGHT MODE
MOUNTING THREAD
ADJUSTABLE STANDING BASE
CHARGING TIME 3.5h
WORKING TIME 3h LAMP TORCH 4h TORCH
3.7V 2000mAh Li-ion
BATTERY INDICATOR
HANGING HOOK x2
IP20

Ref.	⊠	EAN
99-072	25/50	5907558464962



Naświetlacz

Floodlight / Scheinwerfer / Прожектор / Прожектор / Diszkvilágítás / Projector / Světlo / Svetlo / Reflektor / Prožektorius / Floodlight / Floodlight / Прожектор / Reflektor / Φωοδύεξμη / Προβολέας / Luz de inundación / Proiettore / Floodlight / Projecteur / Schijnwerper

1st click:



2nd click:



3rd click:



4th click: OFF



10W
750
max lm

COB
LED

HANDLE/
SUPPORT

ABS

IP20

POWER
BANK



Zasilane 3xAA lub 2x18650
Powered by 3xAA or 2x18650
Работает на 3xAA или 2x18650

Ref.	📦	EAN
99-038	0/40	5907558452297

30W
3000
max lm

POWER
BANK

CHARGER
INCLUDED

SMD
LED

BATTERY
Li-ion
3.7V
8000mAh

ABS
+
AL

CAPACITY
INDICATION

USB C
charger
+ cable

4.5h
charging

ADJUSTABLE
SUPPORT

TRANSPORT
HANDLE

IP54

210x
180x
55 mm

1st click:

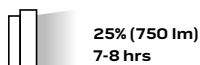

2nd click:

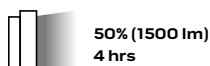

3rd click:

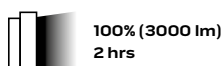

4th click: OFF



Ref.	📦	EAN
99-064	0/10	5907558464887

1st click:
Large LED
100% max 2 h

2nd click:
Small LED
100% max 5 h

3rd click: OFF
press 3 seconds:
Both LEDs
100% max 2 min

750
+250
max lm

10W
+3W

CREE
+CREE XPG
LED

HANDLE/
SUPPORT

POWER
BANK

BATTERY
Li-ion
3.7V
2600mAh

ABS
+
TPR

USB
charger
+ cable

4.5h
charging

IP20



Ref.	📦	EAN
99-040	10/20	5907558452310

Latarka inspekcyjna + laser + UV

Inspection lamp + laser + UV / Inspektionslampe + Laser + UV / Инспекционная лампа + лазер + УФ / Инспекційна лампа + лазер + УФ / Ellenőrző lámpa + lézer + UV / Lampa de inspectie + laser + UV / Inspekční lampa + laser + UV / Inspekcijna lampa + laser + UV / Inspekcijna svetilka + laser + UV / Apžiūros lempa + lazeris + UV / Pārbaudes lampa + lāzers + UV / Kontrolllamp + laser + UV / Инспекционная лампа + лазер + UV / Inspekcijska lampa + laser + UV / Inspekcijska lampa + laser + UV / Λάμπα επιθεώρησης + λέιζερ + UV / Lámpara de inspección + láser + UV / Lampada di ispezione + laser + UV / Lâmpada de inspecção + laser + UV / Lampe d'inspection + laser + UV / Inspectielamp + laser + UV

450lm
+
140lm



4in1
LAMP
+
TORCH

DIMMING

COB
LED

LASER

365nm
UV

cable
included
USB C

ALUMINIUM
BODY

MAGNETIC
POCKET
CLIP

CHARGING
TIME

WORKING
TIME

3.7V
800mAh
Li-ion

BATTERY
INDICATOR

5W
+
3W

165mm
x
23mm

IP20



Ref.	📦	EAN
99-077	50/100	5907558465013

Lampa + trójkąt ostrzegawczy

Lamp + warning triangle / Lampe + Warndreieck / Лампа + предупреждающий треугольник / Лампа + трикутник попередження / Lámpa + figyelmeztető háromszög / Lampă + triunghi de avertizare / Lampa + výstražný trojúhelník / Lampa + výstražný trojuholník / Svetilka + opozorilni trikotnik / Lampa + isprejamsis trikapis / Lampa + brīdinājuma trīsstūris / Lamp + hoiatussurk / Лампа + предупредителен триъгълник / Lampa + trokut upozorenja / Лампа + троугао упозорења / Λάμπα + προειδοποιητικό τρίγωνο / Lámpara + triángulo de advertencia / Lampada + triangolo di emergenza / Lâmpada + triângulo de advertência / Lampe + triangle de présignalisation / Lamp + gevarendriehoek

1st click:



2nd click:

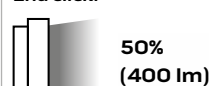

3rd click:



4th click: OFF

10W
800
max lm

COB
LED

RUBBER
POINTS

ADJUSTABLE
HANDLE/
SUPPORT

x4
AA
NOT
INCLUDED

NYLON
+TPR
BODY

220x
220x
45 mm



Ref.	📦	EAN
99-076	5/10	5907558465006



Lampa z czujnikiem ruchu

Lamp with motion sensor / Лампа с датчиком движения / Lampă cu senzor de mișcare / Lámpa mozgásérzékelővel / Лампа з датчиком руху / Svetidlo so snímačom pohybu / Lampa se snímačom pohybu / Lampe mit Bewegungssensor / Svetilka s senzorjem gibanja / Lampa su judesio jutikliu / Lampa ar kustības sensoru / Liikumisanduriga lamp / Лампа със сензор за движение / Svetiljka sa senzorom pokreta / Лампа са сензором покрета / Λάμπα με αισθητήρα κίνησης / Lámpara con sensor de movimiento / Lampada con sensore di movimento / Lâmpada com sensor de movimento / Lampe avec détecteur de mouvement / Lamp met bewegingssensor



230V 50Hz	SMD LED	MOTION DETECTOR	NO DIMM
60 % <0.5s	30000h work time	CRI Ra≥70	6500 K
-20°< >40°	BEAM ANGLE >100°	CABLE 15cm	ALUMINIUM BODY
PF>0.9	ON/OFF ≥15000	IP65	



Ref.	P [W]	[lm]	☒	EAN
99-094	10	800	0/60	5907558469554
99-049	30	2400	0/20	5907558452464
99-050	50	5000	0/10	5907558452471

Lampa

Lamp / Lampe / Лампа / Лампа / Lámpa / Lampă / Lampa / Lampe / Svetilka / Lampa / Lampa / Lamp / Лампа / Лампа / Лампа / Λάμπα / Lámpara / Lampada / Lâmpada / Lampe / Lamp /

SMD LED	50W 4500 max lm	230V 50Hz	CABLE 2m EU plug	BEAM ANGLE >120°	6500 K	25000h work time
60 % <1.0s	ON/OFF ≥15000	CRI Ra≥80	PF>0.9	-25°< >45°	NO DIMM	IP65

SMD LED	230V 50Hz	30000h work time	6500 K	ALUMINIUM BODY	IP65	BEAM ANGLE >100°
CRI Ra≥70	60 % <0.5s	ON/OFF ≥15000	CABLE 15cm	NO DIMM	-40°< >50°	PF>0.8



Ref.	P [W]	[lm]	☒	EAN
99-063	50	4500	0/10	5907558452600

Ref.	P [W]	[lm]	☒	EAN
99-093	10	800	0/60	5907558469547
99-051	20	1600	0/40	5907558452488
99-052	30	2400	0/30	5907558452495
99-053	50	4000	0/20	5907558452501
99-054	100	8000	0/10	5907558452518



Lampa

Lamp / Lampe / Лампа / Лампа / Lámpa / Lampă / Lampa / Lampa / Svetilka / Lampa / Lampa / Lamp / Лампа / Lampa / Lampa / Lámpa / Lámpara / Lampada / Lampe / Lamp

- 100W
- 8500 lm
- 230V
- 50Hz
- SMD LED
- 6500 K
- BEAM ANGLE >110°
- 25° < >45°
- ON/OFF ≥15000
- 25000h work time
- CRI Ra ≥ 80
- 60 W
- <1s
- max 1.8m
- NO DIMM
- CABLE 3m
- DF > 0.9
- IP65



Ref.	P [W]	[lm]	☒	EAN
99-095	100	8500	0/2	5907558469561

- SMD LED
- H 1.8 m MAX
- 6500 K
- 25000h work time
- 230V
- 50Hz
- BEAM ANGLE >120°
- 60 W
- <1.0s
- PF > 0.9
- CRI Ra ≥ 80
- CABLE 3m EU plug
- NO DIMM
- 25° < >45°
- ON/OFF ≥15000
- IP65



Ref.	P [W]	[lm]	☒	EAN
99-059	30	2700	0/4	5907558452563
99-060	50	4500	0/4	5907558452570

- 2x100W
- 16400 lm
- 230V
- 50Hz
- SMD LED
- 6500 K
- ON/OFF ≥15000
- 25000h work time
- BEAM ANGLE >110°
- 25° < >45°
- CRI Ra ≥ 80
- max 1.8m
- CABLE 3m
- 60 W
- <1s
- NO DIMM
- DF > 0.9
- ON/OFF switch
- IP65



Ref.	P [W]	[lm]	☒	EAN
99-096	200	8500	0/2	5907558469578

- 230V
- 50Hz
- SMD LED
- H 1.8 m MAX
- BEAM ANGLE >120°
- 6500 K
- 25000h work time
- 60 W
- <1.0s
- PF > 0.9
- 25° < >45°
- NO DIMM
- CRI Ra ≥ 80
- CABLE 3m EU plug
- ON/OFF ≥15000
- IP65



Ref.	P [W]	[lm]	☒	EAN
99-061	2x 30	5400	0/4	5907558452587
99-062	2x 50	9000	0/4	5907558452594





NORMALIA WARSZTATOWE

workshop
standard items

стандартні предмети
майстерні

Szczypce do klipsów

Trim clip removal pliers / Trimmzange zum Entfernen des Clips / Плоскогубцы для удаления клипсы / Плоскогубцы для удаления клипсы / Vágókarpos-eltávolító fogók / Clesti pentru scoaterea clemelor / Kleště na odstranění klipů / Kliešte na odstraňovanie spôn / Klešče za odstranjevanje sponk / Sqvaržu šalinimo replės / Klipi porėtšanas knaibles / Klambrite eemaldamise tangid / Клеци за премахане на клип / Klijesta za uklanjanje isječaka / Кљешта за уклањање клипа / Πένσα αφαίρεσης κλιπ / Recorte alicates de extracción de clip / Pinza per tagliare clip / Alicates de remoção de cliques de acabamento / Pince pour enlever les clips / Tang voor verwijderen van clip

25
years
GUARANTEE

35x35
mm



Ref.	📦	EAN
11-030	6/36	5907558445527

Zestaw ściągaczy do tapicerki

Upholstery puller set / Lösehebel-Satz für Polster / Набор съёмников панелей облицовки / Набор знімачів до обивки салону / Kárpiteszedő készlet / Set de scos piese de tapiterie / Sada pro demontáž čalounění / Súprava na demontáž čalúnenia / Set smnalceev oblazinijerija / Tvirtinimo elementu ištraukiklių / Tapšėjuma novilcėju / Polstriřtõmmitsate / Комплект скобу за тапицерия / Set za skidanje tapicerung / Pribor alata za skidanje tapetarskog materijala / Σετ εξαλλκείς πλακών επένδυσης / Juego de extractores de tapizado / Serie di utensili per interni / Conjunto de extratores para tapeçaria / Jeu d'extracteurs de tapisserie / Set van trekkers voor stuffing



Ref.	📦	EAN
11-825	6/12	5907558436808

NYLON



Ref.	N	📦	EAN
11-822	x5	6/24	5907558420029
11-823	x6	6/24	5907558420036
11-824	x11	0/10	5907558420043

Opaska ślimakowa

Hose clamp / Schneckenschelle / Хомут червячный / Хомут гвинтований / Tömrlöbilincs / Brätaå cu melc / Šneková spona / Stáhovacia páska kovová / Objemka na polža / Sqvarža / Gliemežšavilcējs / Toruklamber / Скоба с червячна резба / Obujmica sa ružnim navojem / Šelna / Обонτωός σφιγκτήρας σωλήνα / Bidas / Fascetta a vite / Abraçadeira caracol / Collier de serrage

STAINLESS
steel

W4



Ref.	Ø [mm]	N	📦	EAN
11-400	8-12 / 9 mm	x3	0/200	5907558420425
11-401	10-16 / 9 mm	x3	0/200	5907558420432
11-402	12-20 / 9 mm	x3	0/200	5907558420449
11-403	16-27 / 9 mm	x3	0/200	5907558420456
11-404	20-32 / 9 mm	x3	0/200	5907558420463

x34



Ref.	📦	EAN
11-981	0/20	5907558435764

Nity

Rivets / Niete / Закленки / Закленки / Alu popszegecs készlet / Nituri / Nýty / Nity / Zakovice / Kniedes / Kniedes / Needitangid / Нитове / Zakovice / Nitna / Πριτσίνια / Remaches / Rivetti / Rebites / Rivets / Klinknagels /

AL x400



Ref.	Ø [mm]	📦	EAN
11-970	2.4, 3.2, 4.0, 4.8	0/20	5907558437126



Zestaw spinek samochodowych

Car pins / Auto-Körper-Clipsset / Клипсы крепления обшивки / Набор кліпс кріплення обшивки / Gépkocsi rögzítő patent készlet / Set de clipuri auto / Sada přichytek čalounění / Súprava sponek do auta / Set avtomobilskih sponk / Avtomobilnių tvirtinimo elementų rinkinys / Apšuvima stiprinājumi komplekts / Autotihvide komplekt / Комплект автомобильни щипки / Set spona za vozila / Komplet spojnice za automobile / Κλιπς ταπεταρίας / Kit de remaches de coche / Set di clip per carrozzeria / Luvas de nitrilo laranja / Ensemble d'épingles auto / Auto pinnen



x300

OPEL

Ref.	☒	EAN
11-952	0/28	5907558436990



x345

PEUGEOT

Ref.	☒	EAN
11-953	0/28	5907558437003



x408

HONDA

Ref.	☒	EAN
11-956	0/28	5907558437034



x415

MITSUBISHI

Ref.	☒	EAN
11-960	0/28	5907558437072



x290

BMW

Ref.	☒	EAN
11-961	0/28	5907558437089



x360

TOYOTA
LEXUS

Ref.	☒	EAN
11-950	0/28	5907558436976



x255

VOLKSWAGEN

Ref.	☒	EAN
11-963	0/28	5907558437102

Pierścienie segera

Seeger rings / Seeger-Ring / Стопорные кольца / Кільця стопорні / Seeger gyűrűk / Inele Seeger / Segerové kroužky / Segerove krúžky / Seger obroči / Žiedai Segera / Arējie un iekšējie spriegredzeni / Seeger ringid / Зегерки / Uskačnici / Seger prstenovi / Δακτύλιοι συγκράτησης / Anillos seger / Anelli Seeger / Anéis Seeger / Anneaux élastiques / Segger ringen

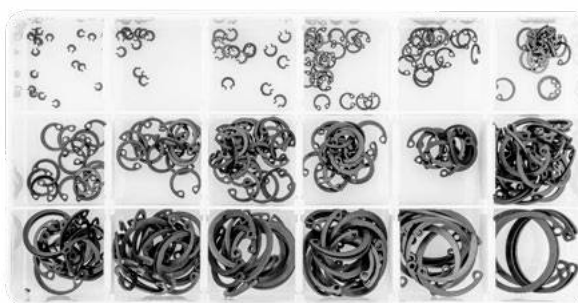

x300

Ref.	☒	EAN
11-975	0/20	5907558437171

Nakrętki samohamowne

Self-locking nuts / Selbstsichernde Muttern / Самоконтрящиеся гайки / Гайки самоконтряючі / Űnzáró anyák / Piulițe cu auto-blocare / Samosvorné matice / Samosvorné matice / Samozaporne matice / Savaitte užsifiksuojaiančios veržlės / Pašbremzėjošie užgriežni / Iseblokeeruvad mutrid / Самозаконтрящи гайки / Samokočive matice / Samokočne matice / Παξιμόδια αυτοσφραλιζόμενα / Tuercas autoblocantes / Dadi autobloccanti / Porcas autotravantes / Écrous freins / Zelfverschuilende moeren

x146



Ref.	Ø [nr]	📦	EAN
11-972	M4 - M12	0/20	5907558437140

Korki z uszczelkami miedzianymi

Drain plugs and copper pads / Verschlusschrauben mit Kupferdichtungen / Набор медных прокладок и пробок / Набор мідних прокладок і пробки / Menetes dugó és rézalátét készlet / Buşoane cu garnituri din cupru / Zátky s měděným těsněním / Zátky s medenými tesneniami / Čepi za medeninastimi tesnilii / Variniai kamščiai ir tarpinės / Väciņi ar vara starplikām / Vasktihenditega korgid / Пробки за източване с медни уплътнения / Затварячи с месингастим бртвama / Komplet čerova sa bakarnim zaprtivcma / Σετ χάλκινων παρεμβυσμάτων και ταπών / Tapones con juntas de cobre / Tappi con guarnizioni in rame / Tampões com anéis de cobre / Bouchons avec joints en cuivre / Krukken met messing dichting

x534



Ref.	📦	EAN
11-974	0/10	5907558437164

Podkładki miedziane

Coper pads / Unterlegscheiben aus Kupfer / Медные шайбы / Шайби мідні / Réz alátétek / Şaibe de cupru / Měděné podložky / Medené podložky / Medeninaste podložke / Varinés tarpinés / Vara starplikas / Vasest seibid / Медни шайби / Mesingasti podložci / Bakarne podložke / Χάλκινες ροδέλες / Arandelas de cobre / Rondelle in rame / Anéis de cobre / Rondelles en cuivre / Roestvrije onderringen

x300

Cu



Ref.	📦	EAN
11-971	0/10	5907558437133

x150



Ref.	📦	EAN
11-979	0/20	5907558435740

Zestaw smarowniczek

Set of lubricating nipples / Ölerset / Набор маслёнок / Набор оливиць / Zsízószem készlet / Set de cãni de ungere / Sada mazniček / Súprava mazniček / Komplet mazalnic / Sutepimo dozatorių komplektas / Eļļas kanniņu komplekts / Määrdepritside komplekt / Комплект ръчни маслёнки / Set dozera za mazivo / Komplet maziva / Σετ ελαιοδεξαμενών / Juego de pistolas engrasadoras / Completo di punti di ingrassaggio / Kit de lubrificadores / Jeu de tubulure de graissage / Set van smeernippels

x110

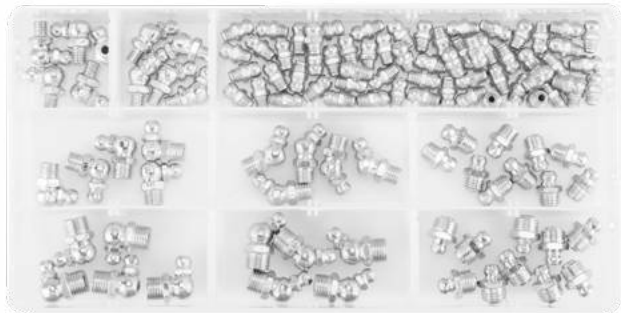

Ref.	📦	EAN
11-973	0/20	5907558437157

Sprężyny

Springs / Federn / Пружини / Пружини / Rugó készlet / Arcuri / Pružiny / Pružiny / Vzmeti / Spyruoklių rinkinys / Atsperes / Vedrud / Пружини / Opruge / Opruge / Σετ ελατήρια / Espirales / Molle / Molas / Ressorts / Veren

x200

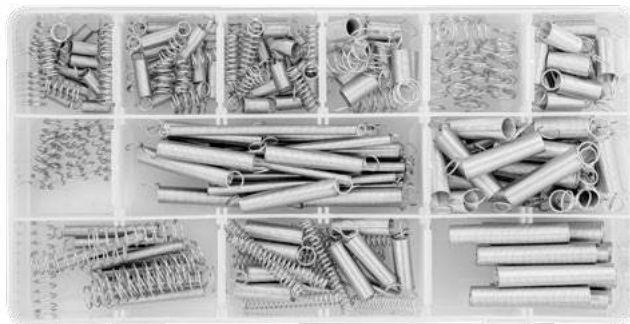

Ref.	📦	EAN
11-980	0/20	5907558435757



Koszulki termokurcziwe

Heat shrink sleeves / Wärmeschrumpfende Hüllen / Термоусадочные рукава / Рукави термоусадочни / Zsugorcsó készlet / Manşoane termocontractabile / Teplem smršťitelné rukávy / Teplom zmršťitelné návleky / Toplatno-skrčné spojky / Termiškai susitraukiančios rankovės / Termorucigās uzmaivas / Termokahanevad sárgjíd / Термосуваеми рукави / Termo savitljivi rukavi / Rukavi koji se skupljaju na toploti / Θερμοσυστελλόμενα μονωτικά καλωδίων / Mangas termoencogibles / Guaine termorestringenti / Mangas termoretráteis / Gaines thermorétractables / Thermokrimp mouwen

x127



Ref.	☒	EAN
11-978	0/20	5907558437201

Uszczelki (O-ring NBR)

Seals (O-ring NBR) / Dichtungen (O-ring NBR) / Прокладки (O-ring NBR) / Прокладки (O-ring NBR) / Tömítés készlet (o-gyűrű nbr) / Garnturi (O-ring NBR) / Těsnění (O-ring NBR) / Tesnenia (O-ring NBR) / Tesnila (O-ring NBR) / Tarpinés (O-ring NBR) / Blives (O-ring NBR) / Tihendid (O-ring NBR) / Γαρνιτυρι (O-ring NBR) / Brtvila (O-ring NBR) / Zaptivke (O-ring NBR) / Ταμώχες (O-ring NBR) / Juntas de calafateo (O-ring NBR) / Guarnizioni (O-ring NBR) / Vedantes (O-ring NBR) / Joints (O-ring NBR) / Dichtringen (O-ring NBR)

x225



Ref.	☒	EAN
11-977	0/20	5907558437195

Uszczelki

Seals / Dichtungen / Прокладки / Прокладки / Tömítések / Garnturi / Těsnění / Tesnenia / Tesnila / Tarpinés / Blives / Tihendid / Γαρνιτυρι / Brtvila / Zaptivke / Ταμώχες / Juntas de calafateo / Guarnizioni / Vedantes / Joints / Dichtringen

x419

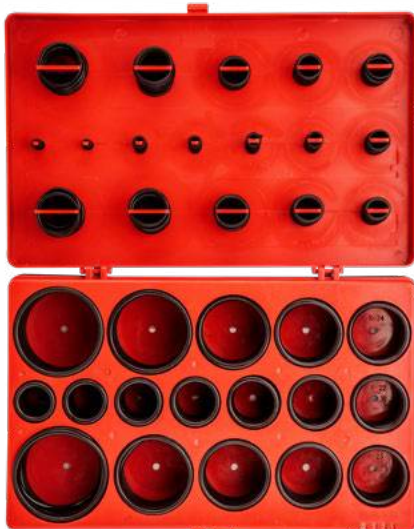

Ref.	☒	EAN
11-983	1/20	5907558435788

Koszulki termokurcziwe "samolutujące"

Heat-shrink solder sleeves / Schrumpfschläuche / Термоусадочные трубки «самоустанавливающиеся» / Термоусадочни тръбки «Самопа̀ика» / Hőre zsugorodó, „önforrasztó” cső / Manşoane termocontractabile „auto-lipire” / Smršťovací „pájeci” spojky s cinem / Termozmršťovacie bužírky „samospájkovacie” / Termokrčljive tape / Karštje susitraukiantys vamzdėliai / "Pašlodėjošas" termiskas sarašanās caurules / "Isejotvad" termokahanevad torud / Термосуваеми маркучи „самопопяващи” / "Samolemljive" termoskupljajuće košuljice / "Samolemljive" termoskupljajuće košuljice / Θερμοσυστελλόμενα μακαρόνια / Mangas termoencogibles / Guaine termorestringenti / Mangas termoretráteis / Gaines thermorétractables / Thermokrimp mouwen

100 pcs
0.25 - 6.0 mm



Ref.	☒	EAN
11-969	1/200	5907558471069

Uszczelki (O-ring HNBR)

Seals (O-ring HNBR) / Dichtungen (O-ring HNBR) / Прокладки (O-ring HNBR) / Прокладки (O-ring HNBR) / Tömítés készlet (O-gyűrű hnbr) autóklimához / Garnturi (O-ring HNBR) / Těsnění (O-ring HNBR) / Tesnenia (O-ring HNBR) / Tesnila (O-ring HNBR) / Tarpinés (O-ring HNBR) / Blives (O-ring HNBR) / Tihendid (O-ring HNBR) / Γαρνιτυρι (O-ring HNBR) / Brtvila (O-ring HNBR) / Zaptivke (O-ring HNBR) / Ταμώχες (O-ring HNBR) / Juntas de calafateo (O-ring HNBR) / Guarnizioni (O-ring HNBR) / Vedantes (O-ring HNBR) / Joints (O-ring HNBR) / Dichtringen (O-ring HNBR)

x270



Ref.	☒	EAN
11-976	0/20	5907558437188

Zestaw bezpieczników samochodowych

Car fuse / Set von Auto-Sicherungen / Набор автомобильных предохранителей / Набор запобіжників автомобільних / Gépkocsi biztosíték szett / Set de siguranțe auto / Sada pojistek do auta / Sada automobilových poistiek / Set avtomobilskih varovalk / Automobiliu saugiklių rinkinys / Automašīnu drošinātāji / Autokaitsmete komplekt / Комплект автомобильни предпазители / Set osigurača za auto / Komplet svečica za avtomobil / Σετ ασφαλείας αυτοκινήτου / Conjunto de fusibles de coche / Set di fusibili per auto / Kit de fusíveis de automóveis / Ensemble de fusibles auto / Auto bougies

x88



Ref.	☒	EAN
11-993	0/20	5907558435818

Zestaw bezpieczników samochodowych

Car fuse / Set von Auto-Sicherungen / Набор автомобильных предохранителей / Набор запобіжників автомобільних / Gépkocsi biztosíték szett / Set de siguranțe auto / Sada pojistek do auta / Sada automobilových poistiek / Set avtomobilskih varovalk / Automobilių saugiklių rinkinys / Automašinu drošinātāji / Autokaitismete komplekt / Комплект автомобильни предпазители / Set osigurača za auto / Komplet svečica za automobil / Set ασφάλειες αυτοκινήτου / Conjunto de fusibles de coche / Set di fusibili per auto / Kit de fusíveis de automóveis / Ensemble de fusibles auto / Auto bougies



x10

Ref.	📦	EAN
11-991	50/200	5907558435795

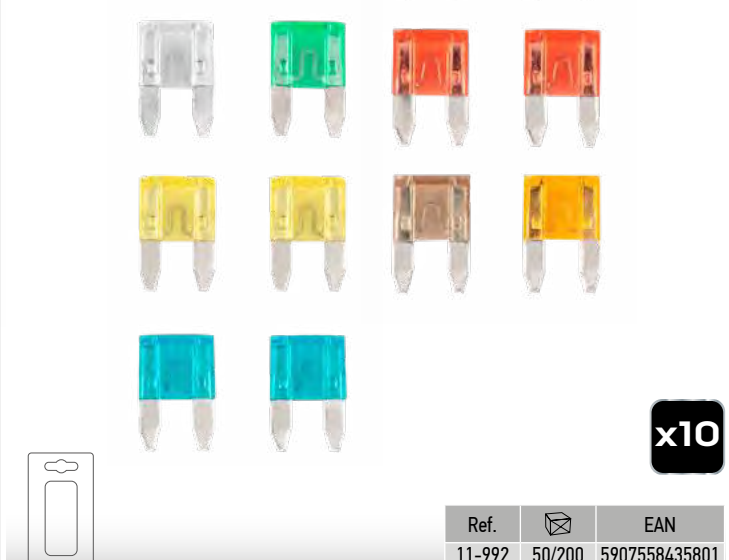

x10

Ref.	📦	EAN
11-992	50/200	5907558435801

Opaski zaciskowe

Band clips / Klemmschellen / Хомутики стяжніе / Хомути стяжні / Kábelkötégető / Cleme conexiune / Hadicové pásky / Fixačné pásky / PVC vezice / Užspauđejas / Savilcēji / Rihmaklamber / PVC vezice / Κολλάρα σύσφιξης / Fascette per cavi / Cintas p. grampear / Bride de serrage / Klemmbanden

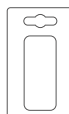
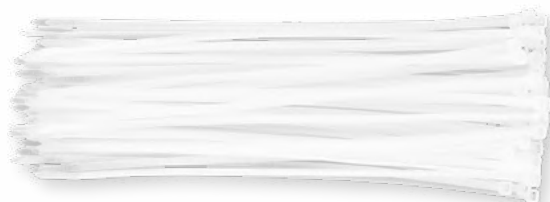

Ref.	color	W [mm]	L [mm]	N	📦	EAN
01-600	■	2.5	100	100	0/250	5907558468007
01-601	□	2.5	200	100	0/250	5907558468014
01-602	■	2.5	200	100	0/250	5907558468021
01-603	■	3.6	300	100	0/125	5907558468038
01-604	□	3.6	300	100	0/125	5907558468045
01-605	□	2.5	100	100	0/250	5907558468052
01-606	■	3.6	200	100	0/200	5907558468069
01-607	□	4.8	200	75	0/200	5907558468076
01-608	■	4.8	200	75	0/200	5907558468083
01-609	□	4.8	300	75	0/150	5907558468090
01-610	■	4.8	300	75	0/150	5907558468106
01-611	□	4.8	370	75	0/100	5907558468113
01-612	■	4.8	370	75	0/100	5907558468120
01-613	■	7.6	500	75	0/50	5907558468137
01-614	□	7.6	500	75	0/50	5907558468144

Taśma naprawcza

Repair tape / Ремонтная лента / Ремонтна стрічка / Javítószalag / Repararea benzii / Páska opravná / Opravná páska



Ref.	W [mm]	L [m]	📦	EAN
56-040	48	20	0/24	5907558446463

Taśma izolacyjna

Insulating tape / Isolierband / Лента ізоляційна / Стрічка ізоляційна / Szigetelőszalag / Banda izolatoare / Izolační páska / Páska izolačná / Izolacijski trak / Izolavimo juosta / Izolācijas lentā / Isolatierpe / Izolir traka / Ταβία μόνωσης / Nastro isolante / Fita de isolação / Bande isolante / Isolatiebänd



Ref.	W [mm]	L [m]	kolor	📦	EAN
01-528	15	10		0/500	5907558439335
01-526	15	10	■	0/500	5907558439311





CHEMIA MOTORYZACYJNA

automotive chemicals автoмобільна хімія

Pasta želova do mycia rąk usuwa trudne zabrudzenia

/ Gel paste for cleaning hands of persistent dirt / Gel-Handwaschpaste, entfernt hartnäckigen Schmutz / гелевая паста для мытья рук удаляет сильные загрязнения / гелевая паста для мытья рук удаляет складки загрязнения / A zselé formájú kézmosó paszta eltávolítja a makacs szennyeződéseket / Pasta-gel pentru spălarea mâinilor îndepărtează murdăria persistentă / Gelová pasta na mytí rukou odstraňuje odolné nečistoty / Gélová pasta na umývanie rúk odstraňuje silné znečistenie / Gel pasta za umivanje rok odstranjuje trdovratne madeže / Geliné pasta rankoms plauti pašalina sunkiai įveikiamus nešvarumus / Gela pasta roku mazgāšanai noņem stiprus netīrumus / Geeljas kätapesupasta eemaldab ka tugeva määrdumise / гел-паста за измиване на ръце за отстраняване на силни замърсявания / Pasta u gelu za pranje ruka, uklanja tvrdokorna zaprljanja / Pasta u gelu za uklanjanje tvrdokornih zaprljanja / πάστα τζελ για το πλύσιμο των χεριών αφαιρεί δύσκολή βρομιά / Pasta gel lavamanos para eliminar la suciedad persistente / Una pasta gel lavamani le sporozie difficili da rimuovere / Pasta de gel para lavar mãos que remove a sujeira difícil / Pâte gel pour le lavage des mains ; élimine les saletés tenaces / De gel pasta voor het wassen van de handen die hardnekkig vuil verwijdert



500g

Ref.	Color	⊞	EAN
10-401	Orange	1/0	5907558467154
10-403	Yellow	1/0	5907558467178
10-405	White	1/0	5907558467192



4.0L

Ref.	Color	⊞	EAN
10-402	Orange	1/0	5907558467161
10-404	Yellow	1/0	5907558467185
10-406	White	1/0	5907558467208

Uniwersalne chusteczki czyszczące do rąk

All-purpose hand wipes / Allzweck-Handreinigungstücher / Универсальные чистящие салфетки для рук / Универсални серветки для очищаня рук / Univerzális kéztisztító törölkendők / Servetele universale pentru curățarea mâinilor / Univerzálni ubrousky na čištění rukou / Univerzálne utierky na čistenie rúk / Univerzalni čistilni robčki za roke / Universalios rankų valymo servetėlis / Univeršālas roku tīršanas salvetes / Universaalsed kāterpuhastusrätikud / Универсални кърпички за почистване на ръце / Univerzalne maramice za pranje ruku / Univerzalne maramice za pranje ruka / Μαντηλάκια καθαρισμού χεριών γενικής χρήσεως / Toallitäs lavamanos multiuso / Fazzoletti universali per pulire le mani / Toalhetes universais para limpar mãos / Lingettes nettoyantes universelles pour les mains / Universele reinigungsdoekjes voor de handen

Chusteczki ze ścierniwem do mycia rąk oraz czyszczenia powierzchni i narzędzi

Abrasive grit wipes for cleaning hands, surfaces and tools. / Scheuertücher zum Händewaschen und Reinigen von Oberflächen und Werkzeugen / Абразивные салфетки для мытья рук, очистки поверхностей и инструментов. / Абразивни серветки для мытья рук, очищаня поверхностей и инструментов / Súrolászeres törölkendők kézmosáshoz, valamint felületek és szerszámok makacs szennyeződéskétől való megtisztításához / servetele abrazive pentru spălarea mâinilor și curățarea suprafețelor și a uneltelor / abrazivni ubrousky na mytí rukou a čištění povrchů a nářadí / Utierky s abrazívnou zložkou na čistenie rúk a čistenie povrchov a nástrojov / čistilni brusilni robčki za čiščenje rok, površin in orodij / Abrazivinės servetėlis rankoms plauti ir paviršiams bei įrankiams valyti / Abrazivos salvetes roku tīršanai, kā arī virsmu un instrumentu tīršanai / Abrasiivainega rätikud käte pesemiseks ning pindade ja tööriistade puhastamiseks. / Кърпички с абразив за измиване на ръце и почистване на повърхности и инструменти. / maramice s abrazivom za pranje ruku i čišćenje površina i alata / maramice sa abrazivom za pranje ruka i čišćenje površina i alata. / λειαντικά μαντηλάκια για πλύσιμο χεριών και καθαρισμό επιφανειών και εργαλείων / toallitäs con abrasivos para lavar las manos y limpiar las superficies y herramientas / fazzoletti con abrasivo per lavare le mani e pulire le superfici e gli strumenti di lavoro / Toalhetes com abrasivo para lavar mãos e limpar superfícies e ferramentas / lingettes abrasives pour le lavage des mains et le nettoyage de surfaces et d'outils. / schurende doekjes voor het wassen van de handen en het reinigen van oppervlakken en gereedschap



Ref.	⊞	EAN
10-407	1/0	5907558467215



Ref.	⊞	EAN
10-408	1/0	5907558467222





BHP

OHS охорона праці

Spodnie robocze

Working trousers / Arbeitshose / Брюки рабочие / Штаны рабочие / Munkadzseki / Pantaloni de lucru / Pracovní kalhoty / Montérky / Delovne hlače / Darbinės kelnės / Darba bikses / Тööpüksid / Работни панталони / Radne hlače / Radne pantalone / Παντελόνι εργασίας / Pantalón de trabajo / Pantaloni da lavoro / Calças de trabalho / Pantalon de travail



Ref.	Size	☒	EAN
81-234-XS	XS/46	1/10	5907558470215
81-234-S	S/48	1/10	5907558470222
81-234-M	M/50	1/10	5907558470239
81-234-L	L/52	1/10	5907558470246
81-234-XL	XL/54	1/10	5907558470253
81-234-XXL	XXL/56	1/10	5907558470260
81-234-XXXL	XXXL/58	1/10	5907558470277

Spodnie robocze ogrodniczki

Working dungarees / Arbeitslatzhose / Полукомбинезон / Наніокомбінезон / Munkaruha - kertész nadrág / Pantaloni de lucru cu pieptar / Pracovní kalhoty s lacem / Pracovné pohovce do záhrady / Delovne hlače / Darbinės kelnės (sodininkams) / Dārznieces darba bikses / Töötunked / Градинарски работен панталон / Radne hlače na tregeru / Pantalone za rad u vrtu / Φόρμα εργασίας με τράντες / Pantalón de trabajo tipo mono / Calças de trabalho / Pantalon de travail salopette / Tuinbroek



Ref.	Size	☒	EAN
81-249-XS	XS/46	1/10	5907558470284
81-249-S	S/48	1/10	5907558470291
81-249-M	M/50	1/10	5907558470307
81-249-L	L/52	1/10	5907558470314
81-249-XL	XL/54	1/10	5907558470321
81-249-XXL	XXL/56	1/10	5907558470338
81-249-XXXL	XXXL/58	1/10	5907558470345



Ref.	Size	☒	EAN
81-226-XS	XS/46	12/24	5907558446654
81-226-S	S/48	12/24	5907558446661
81-226-M	M/50	12/24	5907558446678
81-226-L	L/52	12/24	5907558446685
81-226-XL	XL/54	12/24	5907558446692
81-226-XXL	XXL/56	12/24	5907558446708
81-226-XXXL	XXXL/58	12/24	5907558446715



Ref.	Size	☒	EAN
81-246-XS	XS/46	0/15	5907558446722
81-246-S	S/48	0/15	5907558446739
81-246-M	M/50	0/15	5907558446746
81-246-L	L/52	0/15	5907558446753
81-246-XL	XL/54	0/15	5907558446760
81-246-XXL	XXL/56	0/15	5907558446777
81-246-XXXL	XXXL/58	0/15	5907558446784



Możliwość połączenia z bluzą roboczą 81-217 w kombiniezon (wewnętrzny suwak)
Could be matched with jacket 81-217 into jumpsuit by zipper on elastic inner panel
Можно комбинировать с блузой рабочей 81-217 в комбинезон (поиск на резинке на молнии внутри)

Ref.	Size	☒	EAN
81-227-XS	XS/46	0/24	5907558446937
81-227-S	S/48	0/24	5907558446944
81-227-M	M/50	0/24	5907558446951
81-227-L	L/52	0/24	5907558446968
81-227-XL	XL/54	0/24	5907558446975
81-227-XXL	XXL/56	0/24	5907558446982
81-227-XXXL	XXXL/58	0/24	5907558446999



Ref.	Size	☒	EAN
81-247-XS	XS/46	0/20	5907558447002
81-247-S	S/48	0/20	5907558447019
81-247-M	M/50	0/20	5907558447026
81-247-L	L/52	0/20	5907558447033
81-247-XL	XL/54	0/20	5907558447040
81-247-XXL	XXL/56	0/20	5907558447057
81-247-XXXL	XXXL/58	0/20	5907558447064



Spodnie robocze

Working trousers / Arbeitshose / Брюки рабочие / Штаны рабочие / Munkadzseki / Pantaloni de lucru / Pracovní kalhoty / Montérky / Delovne hlače / Darbinės kelnės / Darba bikses / Tööpüksid / Работни панталони / Radne hlače / Radne pantalone / Παντελόν εργασιών / Pantalón de trabajo / Pantaloni da lavoro / Calças de trabalho / Pantalon de travail



POLYAMIDE
90%
SPANDEX
10%

170g/m²

PROFILED

4-WAY STRETCH

CE

Ref.	Size	☒	EAN
81-231-XS	XS/46	0/20	5907558447071
81-231-S	S/48	0/20	5907558447088
81-231-M	M/50	0/20	5907558447095
81-231-L	L/52	0/20	5907558447101
81-231-XL	XL/54	0/20	5907558447118
81-231-XXL	XXL/56	0/20	5907558447125
81-231-XXXL	XXXL/58	0/20	5907558447132



COTTON
98%
ELASTAN
2%

390g/m²

PROFILED

CE

Ref.	Size	☒	EAN
81-228-XS	XS/46	0/20	5907558439427
81-228-S	S/48	0/20	5907558439434
81-228-M	M/50	0/20	5907558439441
81-228-L	L/52	0/20	5907558439458
81-228-XL	XL/54	0/20	5907558439465
81-228-XXL	XXL/56	0/20	5907558439472
81-228-XXXL	XXXL/58	0/20	5907558439489



COTTON
98%
ELASTAN
2%

390g/m²

PROFILED

CE

Ref.	Size	☒	EAN
81-236-XS	XS/46	0/20	5907558467840
81-236-S	S/48	0/20	5907558467857
81-236-M	M/50	0/20	5907558467864
81-236-L	L/52	0/20	5907558467871
81-236-XL	XL/54	0/20	5907558467888
81-236-XXL	XXL/56	0/20	5907558467895
81-236-XXXL	XXXL/58	0/20	5907558467901



COTTON
98%
ELASTAN
2%

410g/m²

PROFILED

CE

Ref.	Size	☒	EAN
81-233-XS	XS/46	0/20	5907558467703
81-233-S	S/48	0/20	5907558467710
81-233-M	M/50	0/20	5907558467727
81-233-L	L/52	0/20	5907558467734
81-233-XL	XL/54	0/20	5907558467741
81-233-XXL	XXL/56	0/20	5907558467758
81-233-XXXL	XXXL/58	0/20	5907558467765



COTTON
98%
ELASTAN
2%

410g/m²

PROFILED

CE

finalist
of the competition

GOOD DESIGN

2020

Ref.	Size	☒	EAN
81-229-XS	XS/46	0/20	5907558439496
81-229-S	S/48	0/20	5907558439502
81-229-M	M/50	0/20	5907558439519
81-229-L	L/52	0/20	5907558443127
81-229-XL	XL/54	0/20	5907558443134
81-229-XXL	XXL/56	0/20	5907558439540
81-229-XXXL	XXXL/58	0/20	5907558439557



COTTON
60%
POLYESTER
37%
SPANDEX
3%

285g/m²

PROFILED

CE

Ref.	Size	☒	EAN
81-238-XS	XS/46	0/20	5907558451658
81-238-S	S/48	0/20	5907558451665
81-238-M	M/50	0/20	5907558451672
81-238-L	L/52	0/20	5907558451689
81-238-XL	XL/54	0/20	5907558451696
81-238-XXL	XXL/56	0/20	5907558451702
81-238-XXXL	XXXL/58	0/20	5907558451719



Spodnie robocze

Working trousers / Arbeitshose / Брюки рабочие / Штани робочи / Munkadzseki / Pantaloni de lucru / Pracovní kalhoty / Montérky / Delovne hlače / Darbinės kelnės / Darba bikses / Тööriksid / Работни панталони / Radne hlače / Radne pantalone / Παντελόνι εργασίας / Pantalón de trabajo / Pantaloni da lavoro / Calças de trabalho / Pantalon de travail

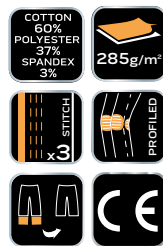

Ref.	Size	⊠	EAN
81-239-XS	XS/46	0/20	5907558451726
81-239-S	S/48	0/20	5907558451733
81-239-M	M/50	0/20	5907558451740
81-239-L	L/52	0/20	5907558451757
81-239-XL	XL/54	0/20	5907558451764
81-239-XXL	XXL/56	0/20	5907558451771
81-239-XXXL	XXXL/58	0/20	5907558451788

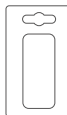

Spodnie robocze ogrodniczki

Working dungarees / Arbeitslatzhose / Полукомбинезон / Нاپівокомбінезон / Munkaruha - kertész nadrág / Pantaloni de lucru cu pieptar / Pracovní kalhoty s laclem / Pracovné pohavice do záhrady / Delovne hlače / Darbinės kelnės (sodininkams) / Dārznieces darba bikses / Тöötunked / Градинарски работен панталон / Radne hlače na tregere / Pantalone za rad u vrtu / Φόρμα εργασίας με τράντες / Pantalón de trabajo tipo mono / Calças de trabalho / Pantalon de travail salopette / Tuinbroek



Ref.	Size	⊠	EAN
81-248-XS	XS/46	0/20	5907558451795
81-248-S	S/48	0/20	5907558451801
81-248-M	M/50	0/20	5907558451818
81-248-L	L/52	0/20	5907558451825
81-248-XL	XL/54	0/20	5907558451832
81-248-XXL	XXL/56	0/20	5907558451849
81-248-XXXL	XXXL/58	0/20	5907558451856



Spodnie robocze na szelkach

Working trousers with suspenders / Arbeitslatzhose / Полукомбинезон рабочий / Півкомбінезон рабочий / Kantáros munkanadrág / Pantaloni de lucru cu bretele / Montérkové kalhoty / Montérky na traky / Delovne hlače z naravnimi / Darbinės kelnės su petnešomis / Darba puskombezonas / Traksidega tööriksid / Работни панталони с тиранту / Radne farmer hlače / Radne pantalone sa tregerima / Φόρμα εργασίας πράτα / Pantalón de trabajo con tirantes / Salopette da lavoro / Jardineiras de trabalho / Pantalon de travail sur bretelles

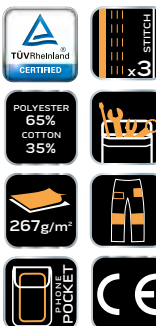

Ref.	Size	⊠	EAN
81-220-S	S/48	0/10	5907558419085
81-220-M	M/50	0/10	5907558419092
81-220-L	L/52	0/10	5907558419108
81-220-LD	L/54	0/10	5907558419115
81-220-XL	XL/56	0/10	5907558419122
81-220-XXL	XXL/58	0/10	5907558419139

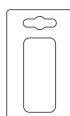

Ref.	Size	⊠	EAN
81-240-S	S/48	0/10	5907558419207
81-240-M	M/50	0/10	5907558419214
81-240-L	L/52	0/10	5907558419221
81-240-LD	L/54	0/10	5907558419238
81-240-XL	XL/56	0/10	5907558419245
81-240-XXL	XXL/58	0/10	5907558419252



Ref.	Size	⊠	EAN
81-230-S	S/48	0/10	5907558419146
81-230-M	M/50	0/10	5907558419153
81-230-L	L/52	0/10	5907558419160
81-230-LD	L/54	0/10	5907558419177
81-230-XL	XL/56	0/10	5907558419184
81-230-XXL	XXL/58	0/10	5907558419191

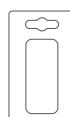

Spodnie robocze

Working trousers / Arbeitshose / Брюки рабочие / Штани робочі / Munkadzseki / Pantaloni de lucru / Pracovní kalhoty / Montérky / Delovne hlače / Darbinės kelnės / Darba bikses / Tööpüksid / Работни панталони / Radne hlače / Radne pantalone / Παντελόνι εργασίας / Pantalón de trabajo / Pantaloni da lavoro / Calças de trabalho / Pantalon de travail



Ref.	Size	☒	EAN
81-225-S	S/48	0/20	5907558435146
81-225-M	M/50	0/20	5907558435153
81-225-L	L/52	0/20	5907558435160
81-225-XL	XL/54	0/20	5907558435177
81-225-XXL	XXL/56	0/20	5907558435184



Ref.	Size	☒	EAN
81-420-S	S/48	0/10	5907558415445
81-420-M	M/50	0/10	5907558415452
81-420-L	L/52	0/10	5907558415469
81-420-LD	L/54	0/10	5907558415476
81-420-XL	XL/56	0/10	5907558415483
81-420-XXL	XXL/58	0/10	5907558415490

Spodnie robocze ogrodniczki

Working dungarees / Arbeitslatzhose / Полукombineзон / Наніюкombineзон / Munkaruha - kertész nadrág / Pantaloni de lucru cu pieptar / Pracovní kalhoty s lacem / Pracovné pohavice do záhrady / Delovne hlače z naramnicami / Darbinės kelnės su petnešomis / Darba puskombinezons / Traksedega tööpüksid / Работни панталони с тупанму / Radne farmer hlače / Radne pantalone sa tregerima / Φάρμα εργασίας τράντα / Pantalón de trabajo tipo mono / Calças de trabalho / Pantalon de travail salopette / Tuinbroek



Ref.	Size	☒	EAN
81-245-S	S/48	10/20	5907558435191
81-245-M	M/50	10/20	5907558435207
81-245-L	L/52	10/20	5907558435214
81-245-XL	XL/54	10/20	5907558435221
81-245-XXL	XXL/56	10/20	5907558435238

Spodnie robocze na szelkach

Working trousers with suspenders / Arbeitslatzhose / Полукombineзон робочий / Півкombineзон робочий / Kantáros munkanadrág / Pantaloni de lucru cu bretele / Montérkové kalhoty / Montérky na traky / Delovne hlače z naramnicami / Darbinės kelnės su petnešomis / Darba puskombinezons / Traksedega tööpüksid / Работни панталони с тупанму / Radne farmer hlače / Radne pantalone sa tregerima / Φάρμα εργασίας τράντα / Pantalón de trabajo con tirantes / Salopette da lavoro / Jardineiras de trabalho / Pantalon de travail sur bretelles



Ref.	Size	☒	EAN
81-430-S	S/48	0/10	5907558415506
81-430-M	M/50	0/10	5907558415513
81-430-L	L/52	0/10	5907558415520
81-430-LD	L/54	0/10	5907558415537
81-430-XL	XL/56	0/10	5907558415544
81-430-XXL	XXL/58	0/10	5907558415551

Spodnie robocze

Working trousers / Arbeitshose / Брюки рабочие / Штани робочі / Munkadzseki / Pantaloni de lucru / Pracovní kalhoty / Montérky / Delovne hlače / Darbinės kelnės / Darba bikses / Tööpüksid / Работни панталони / Radne hlače / Radne pantalone / Παντελόνι εργασίας / Pantalón de trabajo / Pantaloni da lavoro / Calças de trabalho / Pantalon de travail



Ref.	Size	☒	EAN
81-565-S	S/48	0/10	5907558428247
81-565-M	M/50	0/10	5907558428254
81-565-L	L/52	0/10	5907558428261
81-565-XL	XL/56	0/10	5907558428278
81-565-XXL	XXL/58	0/10	5907558428285
81-565-XXXL	XXXL/60	0/10	5907558428292



Ref.	Size	☒	EAN
81-451-S	S/48	0/20	5907558486025
81-451-M	M/50	0/20	5907558486018
81-451-L	L/52	0/20	5907558486001
81-451-XL	XL/54	0/20	5907558486032
81-451-XXL	XXL/56	0/20	5907558486049
81-451-XXXL	XXXL/58	0/20	5907558486056



Kpl. odzieży roboczej

Set of workwear / Satz Arbeitskleidung / Комплект спецодежды / Комплект спецодежды / Munkaruha készlet / Set de haine de lucru / Sada pracovních oděvů / Súprava pracovného oblečenia / Komplet delovnih oblačil / Darbo aprangos komplektas / Darba apģērbi komplekts / Тööriiete komplekt / Комплект работно облекло / Set radne odejbe / Комплект радне одеће / Conjunto de ropa de trabajo / Set di abiti da lavoro / Conjunto de roupa de trabalho / Ensemble de vêtements de travail



Ref.	Size	☒	EAN
81-450-S	S/48	0/10	5907558483369
81-450-M	M/50	0/10	5907558483376
81-450-L	L/52	0/10	5907558483383
81-450-XL	XL/54	0/10	5907558483390
81-450-XXL	XXL/56	0/10	5907558483406
81-450-XXXL	XXXL/58	0/10	5907558483413



Kombinezon roboczy

Working overalls / Arbeitsoverall / Комбинезон рабочий / Комбинезон рабочий / Overall / Combinezon de lucru / Pracovní kombinéza / Pracovná kombinéza / Delovni kombinezon / Darbinis kombinezonas / Darba kombinezons / Тöökombinesoon / Работен комбинезон / Radni kombinezon / Radni kombinezon / Φόρμα εργασίας / Mono de trabajo / Tuta da lavoro / Mascacão de trabalho / Combinaison de travail



Ref.	Size	☒	EAN
81-258-XS	XS/46	0/15	5907558451863
81-258-S	S/48	0/15	5907558451870
81-258-M	M/50	0/15	5907558451887
81-258-L	L/52	0/15	5907558451894
81-258-XL	XL/54	0/15	5907558451900
81-258-XXL	XXL/56	0/15	5907558451917
81-258-XXXL	XXXL/58	0/15	5907558451924



Ref.	Size	☒	EAN
81-250-S	S/48	0/10	5907558419269
81-250-M	M/50	0/10	5907558419276
81-250-L	L/52	0/10	5907558419283
81-250-LD	L/54	0/10	5907558419290
81-250-XL	XL/56	0/10	5907558419306
81-250-XXL	XXL/58	0/10	5907558419313



Bluza robocza

Working top / Arbeitsshirt / Блуза рабочая / Куртка рабочая / Munkadzseki / Blusa de lucru / Pracovní blůza / Pracovná blůza / Delovna jakna / Darbiniai marškiniai / Darba krekls / Тööjakk / Работна блуза / Radna bluz / Radna bluz / Μπλουζά εργασίας / Sudadera de trabajo / Giacca da lavoro / Blusão de trabalho / Veste de travail



Ref.	Size	☒	EAN
81-214-S	S/48	1/10	5907558470154
81-214-M	M/50	1/10	5907558470161
81-214-L	L/52	1/10	5907558470178
81-214-XL	XL/54	1/10	5907558470185
81-214-XXL	XXL/56	1/10	5907558470192
81-214-XXXL	XXXL/58	1/10	5907558470208



Ref.	Size	☒	EAN
81-216-S	S/48	0/20	5907558446593
81-216-M	M/50	0/20	5907558446609
81-216-L	L/52	0/20	5907558446616
81-216-XL	XL/54	0/20	5907558446623
81-216-XXL	XXL/56	0/20	5907558446630
81-216-XXXL	XXXL/58	0/20	5907558446647



Ref.	Size	☒	EAN
81-217-XS	XS/46	0/20	5907558446869
81-217-S	S/48	0/20	5907558446876
81-217-M	M/50	0/20	5907558446883
81-217-L	L/52	0/20	5907558446890
81-217-XL	XL/54	0/20	5907558446906
81-217-XXL	XXL/56	0/20	5907558446913
81-217-XXXL	XXXL/58	0/20	5907558446920



Możliwość połączenia ze spodniami roboczymi 81-227 w kombinezon (elastyczny pas z zamkiem w środku)
Can be matched with jacket 81-227 into a jumpsuit (elastic waistband with a zipper inside)
Можно комбинировать с брюками рабочими 81-227 в комбинезон (пояс на резинке на молнии внутри)



Bluza robocza

Working top / Arbeitsshirt / Блуза рабочая / Къртка работна / Munkadzseki / Bluza de lucru / Pracovní blůza / Pracovná bunda / Delovna jakna / Darbiniai marškiniai / Darba kreklis / Тööjakk / Работна блуза / Radna bluza / Radna bluza / Μηλούζα εργασίας / Sudadera de trabajo / Giacca da lavoro / Blusão de trabalho / Veste de travali

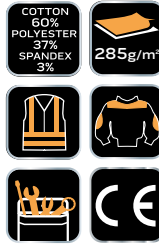

Ref.	Size	☒	EAN
81-218-S	S/48	0/20	5907558451597
81-218-M	M/50	0/20	5907558451603
81-218-L	L/52	0/20	5907558451610
81-218-XL	XL/54	0/20	5907558451627
81-218-XXL	XXL/56	0/20	5907558451634
81-218-XXXL	XXXL/58	0/20	5907558451641



Ref.	Size	☒	EAN
81-210-S	S/48	0/10	5907558419023
81-210-M	M/50	0/10	5907558419030
81-210-L	L/52	0/10	5907558419047
81-210-LD	L/54	0/10	5907558419054
81-210-XL	XL/56	0/10	5907558419061
81-210-XXL	XXL/58	0/10	5907558419078



Ref.	Size	☒	EAN
81-215-S	S/48	0/20	5907558435092
81-215-M	M/50	0/20	5907558435108
81-215-L	L/52	0/20	5907558435115
81-215-XL	XL/54	0/20	5907558435122
81-215-XXL	XXL/56	0/20	5907558435139



Ref.	Size	☒	EAN
81-410-S	S/48	0/10	5907558415384
81-410-M	M/50	0/10	5907558415391
81-410-L	L/52	0/10	5907558415407
81-410-LD	L/54	0/10	5907558415414
81-410-XL	XL/56	0/10	5907558415421
81-410-XXL	XXL/58	0/10	5907558415438

Bluza polarowa

Polar fleece jacket / Arbeitskittel aus Polarfleece / Блуза из флиса / Майстерка / Polár munkadzseki / Bluza polar / Fleeceová mikina / Flísóvá bunda / Јорџ из флиса / Džemperis iš polarinio fliso audinio / Flíša jaka / Fliis / Блузка от флорне / Bluza od polara / Jakna / Μηλούζα φλις / Chaqueta de polar / Giacca in pile / Camisola polar / Polo polaire / Fleece trui



Ref.	Size	☒	EAN
81-506-S	S/48	0/13	5907558441482
81-506-M	M/50	0/13	5907558441499
81-506-L	L/52	0/13	5907558441505
81-506-XL	XL/54	0/13	5907558441512
81-506-XXL	XXL/56	0/13	5907558441529
81-506-XXXL	XXXL/58	0/13	5907558441536



Ref.	Size	☒	EAN
81-500-S	S/48	0/20	5907558419498
81-500-M	M/50	0/20	5907558419504
81-500-L	L/52	0/20	5907558419511
81-500-XL	XL/56	0/20	5907558419528
81-500-XXL	XXL/58	0/20	5907558419535



Bluza polarowa

Polar fleece jacket / Arbeitskittel aus Polarfleece / Блуза из флиса / Μαϊτσερκα / Polár munkadzseki / Bluza polar / Fleecová mikina / Flísová bunda / Jopič iz flisa / Džemperis iš polarinio fliso audinio / Flíša jaka / Fliis / Блузка от флорте / Bluza od polara / Jakna / Μπλούζα φλις / Chaqueta de polar / Giacca in pile / Camisola polar / Polo polaire / Fleece trui



Ref.	Size	☒	EAN
81-501-S	S/48	0/20	5907558429237
81-501-M	M/50	0/20	5907558429244
81-501-L	L/52	0/20	5907558429251
81-501-XL	XL/56	0/20	5907558429268
81-501-XXL	XXL/58	0/20	5907558429275



Ref.	Size	☒	EAN
81-502-S	S/48	1/20	5907558482706
81-502-M	M/50	1/20	5907558482713
81-502-L	L/52	1/20	5907558482720
81-502-XL	XL/54	1/20	5907558482737
81-502-XXL	XXL/56	1/20	5907558482744
81-502-XXXL	XXXL/58	1/20	5907558482751



Ref.	Size	☒	EAN
81-503-S	S/48	1/20	5907558482768
81-503-M	M/50	1/20	5907558482775
81-503-L	L/52	1/20	5907558482782
81-503-XL	XL/54	1/20	5907558482799
81-503-XXL	XXL/56	1/20	5907558482805
81-503-XXXL	XXXL/58	1/20	5907558482812



Ref.	Size	☒	EAN
81-504-S	S/48	1/20	5907558482829
81-504-M	M/50	1/20	5907558482836
81-504-L	L/52	1/20	5907558482843
81-504-XL	XL/54	1/20	5907558482850
81-504-XXL	XXL/56	1/20	5907558482867
81-504-XXXL	XXXL/58	1/20	5907558482874



Bluza dziana

Knitted sweatshirt / Strickbluse / Теплая блуза / Блуза трикотажна / Kötött blúz / Bluz tricotaj / Pletená mikina / Pletená bunda / Pletena bluza / Džemperis / Trikotāžas sporta džemperis / Trikotāzist dressiplusus / Телефон за работа при тежки условия / Bluza od pletenine / Pletena bluza / Μπλούζα πλεκτή σμιμονιού / Sudadera de punto / Felpa in tessuto / Blusão em malha / Blouson tricot / Katoenen trui



Ref.	Size	☒	EAN
81-511-S	S/48	0/20	5907558441420
81-511-M	M/50	0/20	5907558441437
81-511-L	L/52	0/20	5907558441444
81-511-XL	XL/54	0/20	5907558441451
81-511-XXL	XXL/56	0/20	5907558441468
81-511-XXXL	XXXL/58	0/20	5907558441475



Ref.	Size	☒	EAN
81-555-S	S/48	0/10	5907558428063
81-555-M	M/50	0/10	5907558428070
81-555-L	L/52	0/10	5907558428087
81-555-XL	XL/56	0/10	5907558428094
81-555-XXL	XXL/58	0/10	5907558428100
81-555-XXXL	XXXL/60	0/10	5907558428117



Kurtka softshell

Waterproof, windproof jacket, softshell / Wind- und wasserdichte Softshelljacke / Куртка водо- и ветронепроницаемая, softshell / Випірна з водоідутоохувальної тканини «softshell» / Softshell munkadzseki / Djaca impermeabila, antivânt, softshell / Voděodolná, větruvzdorná, softshellová bunda / Vodoodolná, vetruodolná, softshellová bunda / Jakna, odporna na vodu, veter, softshell / Vėjui ir vandeniui atspari striukė („softshell“) / Ūdensnecaurlaidīga vējaka, softshell / Softshell vee- ja tuulekindel jope / Блуза от нолар / Vodootporna, vjetrootporna jakna softshell / Jakna otporna na vodu, veter, sa mekim jezgrom / Αδιάβροχο μπουφάν για προστασία από τον αέρα / Chaqueta impermeable, antiviento, softshell / Giacca antivento, anti pioggia, softshell / Casaco corta vento impermeável pare-brise softshell



Ref.	Size	☒	EAN
81-550-S	S/48	0/10	5907558419542
81-550-M	M/50	0/10	5907558419559
81-550-L	L/52	0/10	5907558419566
81-550-XL	XL/56	0/10	5907558419573
81-550-XXL	XXL/58	0/10	5907558419580

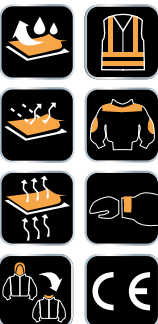

Ref.	Size	☒	EAN
81-551-S	S/48	0/10	5907558427943
81-551-M	M/50	0/10	5907558427950
81-551-L	L/52	0/10	5907558427967
81-551-XL	XL/56	0/10	5907558427974
81-551-XXL	XXL/58	0/10	5907558427981
81-551-XXXL	XXXL/60	0/10	5907558427998

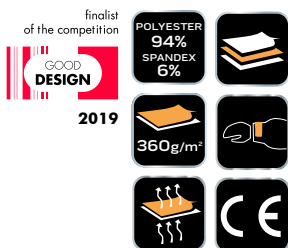

Ref.	Size	☒	EAN
81-558-S	S/48	0/10	5907558434798
81-558-M	M/50	0/10	5907558434804
81-558-L	L/52	0/10	5907558434811
81-558-XL	XL/54	0/10	5907558434828
81-558-XXL	XXL/56	0/10	5907558434835

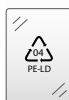

Bluza robocza

Working top / Arbeitsshirt / Рабочая толстовка / Куртка робоча / Munkadzseki / Bluză de lucru / Pracovní blůza / Pracovná bunda / Delovna jakna / Darbiniai marškiniai / Darba krekls / Tööjakk / Рабочна блуза / Radna bluza / Radna bluza / Μηλούζα εργασίας / Sudadera de trabajo / Giacca da lavoro / Blusão de trabalho / Veste de travail



Ref.	Size	☒	EAN
81-556-S	S/48	0/10	5907558428124
81-556-M	M/50	0/10	5907558428131
81-556-L	L/52	0/10	5907558428148
81-556-XL	XL/56	0/10	5907558428155
81-556-XXL	XXL/58	0/10	5907558428162
81-556-XXXL	XXXL/60	0/10	5907558428179



T-shirt

T-shirt / T-Shirt / Футболка сигнальная / Футболка / Póló / T-shirt / Tričko / Tričko / Majica / Apatiniai marškinėliai - T / T-krekls / T-särk / Тушэрт / T-shirt / Majica kratkih rukava / Κοτομάνικη μπλούζα / Camiseta / Maglietta / Camisola / T-shirt / T-shirt



Ref.	Size	☒	EAN
81-609-S	S/48	1/25	5907558470352
81-609-M	M/50	1/25	5907558470369
81-609-L	L/52	1/25	5907558470376
81-609-XL	XL/54	1/25	5907558470383
81-609-XXL	XXL/56	1/25	5907558470390
81-609-XXXL	XXXL/58	1/25	5907558470406



Ref.	Size	☒	EAN
81-640-M	M/50	0/50	5907558483420
81-640-L	L/52	0/50	5907558483437
81-640-XL	XL/54	0/50	5907558483444
81-640-XXL	XXL/56	0/50	5907558483451
81-640-XXXL	XXXL/58	0/50	5907558483468

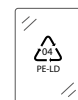

T-shirt

T-shirt / T-Shirt / Футболка сигнальная / Футболка / Póló / T-shirt / Tričko / Tričko / Majica / Apatiniai marškinėliai - T / T-kreikls / T-särk / Тушэpm / T-shirt / Majica kratkih rukava / Κομποάνηκη μπλουζά / Camiseta / Maglietta / Camisola / T-shirt / T-shirt



COTTON 100%

180g/m²





Ref.	Size	☒	EAN
81-642-M	M/50	0/50	5907558483529
81-642-L	L/52	0/50	5907558483536
81-642-XL	XL/54	0/50	5907558483543
81-642-XXL	XXL/56	0/50	5907558483550
81-642-XXXL	XXXL/58	0/50	5907558483567



COTTON 100%

180g/m²





Ref.	Size	☒	EAN
81-641-M	M/50	0/50	5907558483475
81-641-L	L/52	0/50	5907558483482
81-641-XL	XL/54	0/50	5907558483499
81-641-XXL	XXL/56	0/50	5907558483505
81-641-XXXL	XXXL/58	0/50	5907558483512



COTTON 100%

180g/m²





Ref.	Size	☒	EAN
81-643-M	M/50	0/50	5907558483574
81-643-L	L/52	0/50	5907558483581
81-643-XL	XL/54	0/50	5907558483598
81-643-XXL	XXL/56	0/50	5907558483604
81-643-XXXL	XXXL/58	0/50	5907558483611



COTTON 100%

180g/m²





Ref.	Size	☒	EAN
81-610-S	S/48	0/50	5907558432022
81-610-M	M/50	0/50	5907558432039
81-610-L	L/52	0/50	5907558432046
81-610-XL	XL/56	0/50	5907558432053
81-610-XXL	XXL/58	0/50	5907558432060



COTTON 100%

180g/m²





Ref.	Size	☒	EAN
81-648-S	S/48	0/50	5907558482942
81-648-M	M/50	0/50	5907558482959
81-648-L	L/52	0/50	5907558482966
81-648-XL	XL/54	0/50	5907558482973
81-648-XXL	XXL/56	0/50	5907558482980
81-648-XXXL	XXXL/58	0/50	5907558482997



COTTON 100%

180g/m²





Ref.	Size	☒	EAN
81-647-S	S/48	0/50	5907558483000
81-647-M	M/50	0/50	5907558483017
81-647-L	L/52	0/50	5907558483024
81-647-XL	XL/54	0/50	5907558483031
81-647-XXL	XXL/56	0/50	5907558483048
81-647-XXXL	XXXL/58	0/50	5907558483055



COTTON 100%

180g/m²





Ref.	Size	☒	EAN
81-612-S	S/48	0/50	5907558432121
81-612-M	M/50	0/50	5907558432138
81-612-L	L/52	0/50	5907558432145
81-612-XL	XL/54	0/50	5907558432152
81-612-XXL	XXL/56	0/50	5907558432169



COTTON 100%

180g/m²





Ref.	Size	☒	EAN
81-649-S	S/48	0/50	5907558482881
81-649-M	M/50	0/50	5907558482898
81-649-L	L/52	0/50	5907558482904
81-649-XL	XL/54	0/50	5907558482911
81-649-XXL	XXL/56	0/50	5907558482928
81-649-XXXL	XXXL/58	0/50	5907558482935



T-shirt

T-shirt / T-Shirt / Футболка сигнальная / Футболка / Póló / T-shirt / Tričko / Tričko / Majica / Apatiniai marškinėliai - T / T-kreklis / T-särk / Тушэрт / T-shirt / Majica kratkih rukava / Κοτομάνικη μπλούζα / Camiseta / Maglietta / Camisola / T-shirt / T-shirt



Ref.	Size	☒	EAN
81-615-S	S/48	0/50	5907558435344
81-615-M	M/50	0/50	5907558435351
81-615-L	L/52	0/50	5907558435368
81-615-XL	XL/54	0/50	5907558435375
81-615-XXL	XXL/56	0/50	5907558435382



Koszulka polo

Polo shirt / Polo-Shirt / Футболка-поло / Сорочка-поло / Pólóing / Camisa din tesatura / Tričko polo / Polokošela / Majica z ovratnikom / Marškiniai „Polo“ / Polo kreklis / Polosärk / Блуэка зопф / Polo majica / Polo majica / Κοτομάνικη μπλούζα πόλο / Camiseta polo Polo / Camisa pólo / Chemise polo / Polo shirt



Ref.	Size	☒	EAN
81-606-S	S/48	0/40	5907558439809
81-606-M	M/50	0/40	5907558439816
81-606-L	L/52	0/40	5907558439823
81-606-XL	XL/54	0/40	5907558439830
81-606-XXL	XXL/56	0/40	5907558439847
81-606-XXXL	XXXL/58	0/40	5907558439854



Ref.	Size	☒	EAN
81-659-S	S/48	0/25	5907558467918
81-659-M	M/50	0/25	5907558467925
81-659-L	L/52	0/25	5907558467932
81-659-XL	XL/54	0/25	5907558467949
81-659-XXL	XXL/56	0/25	5907558467956
81-659-XXXL	XXXL/58	0/25	5907558467963



Bezrękawnik roboczy

Work body warmer / Arbeitsweste / Жилет рабочий / Безрукавка рабочая / Mellény fényvisszaverő / Vesta de lucru / Pracovní vesta / Pracovní vesta / Delovni brezrokavnik / Darbine liemenė / Darba jaka bez piedurknēm / Töövest / Рабочен енек / Radni prsluk / Radnički prsluk / Γιλέκο εργασίας / Chaleco de trabajo / Gilet de lavoro doppio uso / Blusa de trabalho sem mangas / Gilet de travail



Ref.	Size	☒	EAN
81-534-S	S/48	0/10	5907558441789
81-534-M	M/50	0/10	5907558441796
81-534-L	L/52	0/10	5907558441802
81-534-XL	XL/54	0/10	5907558441819
81-534-XXL	XXL/56	0/10	5907558441826
81-534-XXXL	XXXL/58	0/10	5907558441833



Ref.	Size	☒	EAN
81-530-S	S/48	0/20	5907558427011
81-530-M	M/50	0/20	5907558427028
81-530-L	L/52	0/20	5907558427035
81-530-XL	XL/56	0/20	5907558427042
81-530-XXL	XXL/58	0/20	5907558427059



Ref.	Size	☒	EAN
81-532-S	S/48	0/20	5907558427882
81-532-M	M/50	0/20	5907558427899
81-532-L	L/52	0/20	5907558427905
81-532-XL	XL/56	0/20	5907558427912
81-532-XXL	XXL/58	0/20	5907558427929
81-532-XXXL	XXXL/60	0/20	5907558427936



Koszula flanelowa

Flannel shirt / Flannelhemd / Фланелевая рубашка / Сорочка фланелева / Flanel ing / Cămașă de flanelă / Flanelová košile / Flanelová košeľa / Flanelasta srajca / Flaneliniai marškiniai / Flanela kreklis / Flannelsärk / Фланелена пуза / Košulja od flanela / Flannelska košulja / Φανελένιο πουκάμισο / Camisa de franela / Camicia di flanela / Camisa de flanela / Chemise en flanelle



COTTON
100%



Ref.	Size	☒	EAN
81-540-S	S/48	0/36	5907558432244
81-540-M	M/50	0/36	5907558432251
81-540-L	L/52	0/36	5907558432268
81-540-XL	XL/54	0/36	5907558432275
81-540-XXL	XXL/56	0/36	5907558432282



COTTON
100%



Ref.	Size	☒	EAN
81-541-S	S/48	0/36	5907558432299
81-541-M	M/50	0/36	5907558432305
81-541-L	L/52	0/36	5907558432312
81-541-XL	XL/54	0/36	5907558432329
81-541-XXL	XXL/56	0/36	5907558432336



COTTON
100%



Ref.	Size	☒	EAN
81-545-S	S/48	1/36	5907558484366
81-545-M	M/50	1/36	5907558484373
81-545-L	L/52	1/36	5907558484380
81-545-XL	XL/56	1/36	5907558484397
81-545-XXL	XXL/58	1/36	5907558484403
81-545-XXXL	XXXL/60	1/36	5907558484410



COTTON
100%



Ref.	Size	☒	EAN
81-546-S	S/48	1/36	5907558484427
81-546-M	M/50	1/36	5907558484434
81-546-L	L/52	1/36	5907558484441
81-546-XL	XL/56	1/36	5907558484458
81-546-XXL	XXL/58	1/36	5907558484465
81-546-XXXL	XXXL/60	1/36	5907558484472



Koszula robocza

Work shirt / Arbeitshemd / Рабочая рубашка / Робоца сорочка / Munka ing / Cămașă de lucru / Pracovní košile / Pracovní košeľa / Delovna majica / Darbo marškiniai / Darba kreklis / Töösärk / Работна пуза / Radna košulja / Радна мајица / εργασιό πουκάμισο / Camisa de trabajo / Camicia da lavoro / Camisa de trabalho / Chemise de travail / Werk shirt



COTTON
100%



Ref.	Size	☒	EAN
81-549-S	S/48	0/30	5907558439625
81-549-M	M/50	0/30	5907558439632
81-549-L	L/52	0/30	5907558439649
81-549-XL	XL/54	0/30	5907558439656
81-549-XXL	XXL/56	0/30	5907558439663
81-549-XXXL	XXXL/58	0/30	5907558439670



Koszulka termoaktywna

Thermal long sleeve / Thermo-Funktionsunterwäsche Hemd langarm / Термоактивная блуза / Футболка з довшим рукавом термоактивна / Thermo alüöltözet felső / Cămașă termoactivă / Termoaktivni tričko / Termo tričko / Termo majica / Termo marškinėliai / Termoveļas kreklis / Termoaktiivne alussärk / Термоактивна блуза / Termoaktivna majica / Termoaktivna košulja / Ισοθερμική μπλούζα / Camiseta termoactiva / Maglia termica / Camisola térmica / Chemise thermoactive / Thermoactive shirt



Ref.	Size	☒	EAN
81-660-S/M	S/48 / M/50	0/60	5907558431964
81-660-L/XL	L/52 / XL/54	0/60	5907558431971
81-660-XXL/XXXL	XXL/56 / XXXL/58	0/60	5907558431988



Ref.	Size	☒	EAN
81-661-S/M	S/48 / M/50	0/50	5907558448900
81-661-L/XL	L/52 / XL/54	0/50	5907558448917
81-661-XXL/XXXL	XXL/56 / XXXL/58	0/50	5907558431971



Ref.	Size	☒	EAN
81-662-S/M	S/48 / M/50	0/60	5907558463392
81-662-L/XL	L/52 / XL/54	0/60	5907558463408
81-662-XXL/XXXL	XXL/56 / XXXL/58	0/60	5907558463415

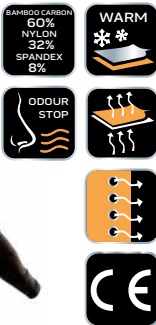

Ref.	Size	☒	EAN
81-663-S/M	S/48 / M/50	0/60	5907558463422
81-663-L/XL	L/52 / XL/54	0/60	5907558463439
81-663-XXL/XXXL	XXL/56 / XXXL/58	0/60	5907558463446

Kalesony termoaktywne

Thermal leggings / Thermo-Funktionsunterwäsche Hose / Термоактивные кальсоны / Кальсоны термоактивни / Thermo alüöltözet alsó / Izmene thermoactive / Termoaktivni kalhoty (spodky) / Termo spodné nohavice / Termo spodnje hlače / Termo kelnės / Termoveļas bikses / Termoaktiivsed pīkad aluspiüksid / Термоактивен клин / Termoaktivne duge gaće / Termoaktivne pantalone / Ισοθερμικό κολών / Mallas termoactivas / Calzamaglia termica / Calças justas térmicas / Caleçon thermoactif / Thermoactive broek



Ref.	Size	☒	EAN
81-670-S/M	S/48 / M/50	0/60	5907558431995
81-670-L/XL	L/52 / XL/54	0/60	5907558432008
81-670-XXL/XXXL	XXL/56 / XXXL/58	0/60	5907558432015



Ref.	Size	☒	EAN
81-671-S/M	S/48 / M/50	0/50	5907558448931
81-671-L/XL	L/52 / XL/54	0/50	5907558448948
81-671-XXL/XXXL	XXL/56 / XXXL/58	0/50	5907558448955



Ref.	Size	☒	EAN
81-672-S/M	S/48 / M/50	0/60	5907558463453
81-672-L/XL	L/52 / XL/54	0/60	5907558463460
81-672-XXL/XXXL	XXL/56 / XXXL/58	0/60	5907558463477

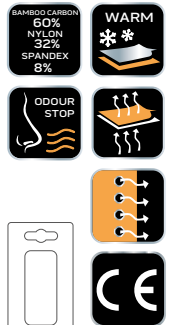

Ref.	Size	☒	EAN
81-673-S/M	S/48 / M/50	0/60	5907558463484
81-673-L/XL	L/52 / XL/54	0/60	5907558463491
81-673-XXL/XXXL	XXL/56 / XXXL/58	0/60	5907558463507



Czapka z latarką

Cap with flashlight / Mütze mit Stirnlampe / Бейсболка с фонариком / Шапка з ліхтарем / Sapka lámpával / Ččaciulá cu lanternă / Čepice s baterkou / Čiapka s baterkou / Kapa z lučkou / Kepurè su žibintuveliu / Cepure ar lukturii / Lambiga müts / Шапка с фенерче / Kapa sa svjetiljkom / Kapa s lampom / Καπέλο τύπου τζόκευ με φακό / Gorra con linterna / Cappello con torcia elettrica / Gorra con lanterna / Casquette avec torche



81-632

81-630

81-631

Ref.	☒	EAN
81-630	0/100	5907558460179
81-631	0/100	5907558460186
81-632	0/100	5907558460193

180lm USB charging
3 light modes
WATER RESISTANT LAMP
CE



180lm USB charging
3 light modes
WATER RESISTANT LAMP
CE



Ref.	☒	EAN
81-621	12/120	5907558428308

Póľubuty robocze

Safety shoes / Arbeitshalschuhe / Полуботинки рабочие / Півчеревики робочі / Munkcipő / Pantofi de lucru / Pracovní obuv / Pracovné poltopánky / Nizki delovni čevlji / Darbo pusbačiai / Darba puszābaki / Töökingad / Работни обувки ниски (половинки) / Radne cipele / Poluduboke radne cipele / Нїжнота ерваіас / Botas de seguridad / Scarpa da lavoro / Sapatos de trabalho / Souliers de sécurité / Werkschoenen



S1 SRC

METAL FREE
ANTISLIP
200J
ANTISTATIC
ANTISHOCK
ABRASION RESISTANT
CE

Ref.	Size	Size [cm]	☒	EAN
82-155-39	39	26	0/10	5907558442908
82-155-40	40	26.7	0/10	5907558442915
82-155-41	41	27.3	0/10	5907558442922
82-155-42	42	28	0/10	5907558442939
82-155-43	43	28.7	0/10	5907558442946
82-155-44	44	29.3	0/10	5907558442953
82-155-45	45	30	0/10	5907558442960
82-155-46	46	30.7	0/10	5907558442977
82-155-47	47	31.3	0/10	5907558442984



S1 SRC

ANTISTATIC
ANTISHOCK
ANTISLIP
200J
CE

Ref.	Size	Size [cm]	☒	EAN
82-090	39	26	0/10	5907558426748
82-091	40	26.7	0/10	5907558426755
82-092	41	27.3	0/10	5907558426762
82-093	42	28	0/10	5907558426779
82-094	43	28.7	0/10	5907558426786
82-095	44	29.3	0/10	5907558426793
82-096	45	30	0/10	5907558426809
82-097	46	30.7	0/10	5907558426816
82-098	47	31.3	0/10	5907558426823



S1P SRA

STEEL METAL
ANTISLIP
ANTISTATIC
ABRASION RESISTANT
ANTISHOCK
200J
CE

Ref.	Size	Size [cm]	☒	EAN
82-010	39	26	0/10	5907558412604
82-011	40	26.7	0/10	5907558414530
82-012	41	27.3	0/10	5907558414974
82-013	42	28	0/10	5907558414981
82-014	43	28.7	0/10	5907558414998
82-015	44	29.3	0/10	5907558415001
82-016	45	30	0/10	5907558415018
82-017	46	30.7	0/10	5907558415025
82-018	47	31.3	0/10	5907558421002



S1 SRC

ANTISHOCK
200J
ANTISHOCK
ANTISTATIC
CE

Ref.	Size	Size [cm]	☒	EAN
82-160-39	39	26	0/10	5907558483970
82-160-40	40	26.7	0/10	5907558483987
82-160-41	41	27.3	0/10	5907558483994
82-160-42	42	28	0/10	5907558484007
82-160-43	43	28.7	0/10	5907558484014
82-160-44	44	29.3	0/10	5907558484021
82-160-45	45	30	0/10	5907558484038
82-160-46	46	30.7	0/10	5907558484045
82-160-47	47	31.3	0/10	5907558484052



Półbuty robocze

Safety shoes / Arbeitshalbschuhe / Полуботинки рабочие / Півчеревики робочі / Munkacisrő / Pantofi de lucru / Pracovní obuv / Pracovné poltopánky / Nizki delovni čevlji / Darbo pusbačiai / Darba puszabaki / Töökingad / Работни обувки ниски (половинки) / Radne cipele / Poluduboke radne cipele / Ημιγυατα εργασις / Botas de seguridad / Scarpa da lavoro / Sapatos de trabalho / Souliers de sécurité / Werkschoenen



SB
SRA



Ref.	Size	Size [cm]	☒	EAN
82-100	39	26	0/10	5907558426830
82-101	40	26.7	0/10	5907558426847
82-102	41	27.3	0/10	5907558426854
82-103	42	28	0/10	5907558426861
82-104	43	28.7	0/10	5907558426878
82-105	44	29.3	0/10	5907558426885
82-106	45	30	0/10	5907558426892
82-107	46	30.7	0/10	5907558426908
82-108	47	31.3	0/10	5907558426915

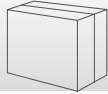

SB
SRA



Ref.	Size	Size [cm]	☒	EAN
82-110	39	26	0/10	5907558426922
82-111	40	26.7	0/10	5907558426939
82-112	41	27.3	0/10	5907558426946
82-113	42	28	0/10	5907558426953
82-114	43	28.7	0/10	5907558426960
82-115	44	29.3	0/10	5907558426977
82-116	45	30	0/10	5907558426984
82-117	46	30.7	0/10	5907558426991
82-118	47	31.3	0/10	5907558427004

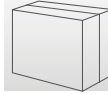

OB
SRA



Ref.	Size	Size [cm]	☒	EAN
82-710	39	26	0/10	5907558430165
82-711	40	26.7	0/10	5907558430172
82-712	41	27.3	0/10	5907558430189
82-713	42	28	0/10	5907558430196
82-714	43	28.7	0/10	5907558430202
82-715	44	29.3	0/10	5907558430219
82-716	45	30	0/10	5907558430226
82-717	46	30.7	0/10	5907558430233
82-718	47	31.3	0/10	5907558430240

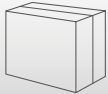

O1
SRC



Ref.	Size	Size [cm]	☒	EAN
82-700	39	26	0/10	5907558430073
82-701	40	26.7	0/10	5907558430080
82-702	41	27.3	0/10	5907558430097
82-703	42	28	0/10	5907558430103
82-704	43	28.7	0/10	5907558430110
82-705	44	29.3	0/10	5907558430127
82-706	45	30	0/10	5907558430134
82-707	46	30.7	0/10	5907558430141
82-708	47	31.3	0/10	5907558430158

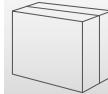

Sandaly robocze

Working sandals / Arbeitssandale / Рабочие сандалии / Sandale de lucru / Робоци стандарти / Munkaszandál / Pracovní sandály / Pracovné sandále / Delovni sandali / Darbo sandalai / Darba sandales / Töösandaalid / Работни сандали / Radne sandale / Radne sandale / Σανδάλια εργασις / Sandalias de trabajo / Sandali da lavoro / Sandálias de proteção / Sandales de travail / Werksandalen



S1
SRC



Ref.	Size	Size [cm]	☒	EAN
82-070-39	39	26	0/10	5907558440812
82-070-40	40	26.7	0/10	5907558440829
82-070-41	41	27.3	0/10	5907558440836
82-070-42	42	28	0/10	5907558440843
82-070-43	43	28.7	0/10	5907558440850
82-070-44	44	29.3	0/10	5907558440867
82-070-45	45	30	0/10	5907558440874
82-070-46	46	30.7	0/10	5907558440881
82-070-47	47	31.3	0/10	5907558440898



OB
SRA



Ref.	Size	Size [cm]	☒	EAN
82-720	39	26	0/10	5907558430257
82-721	40	26.7	0/10	5907558430264
82-722	41	27.3	0/10	5907558430271
82-723	42	28	0/10	5907558430288
82-724	43	28.7	0/10	5907558430295
82-725	44	29.3	0/10	5907558430301
82-726	45	30	0/10	5907558430318
82-727	46	30.7	0/10	5907558430325
82-728	47	31.3	0/10	5907558430332



Trzewiki robocze

Safety boots / Arbeitsschuhe / Ботинки рабочие / Череваци робочі / Munkabakancs / Vocanci de lucru / Kotníková pracovní obuv / Pracovné topánky / Visoki delovni čevlji / Darbo batai / Darba zābaki / Töösaapad / Работна обувка високи / Radne visoke cipele / Radne cipele / Μπoτάκια εργασιών / Botas de seguridad altas / Scarpa alta da lavoro / Botas de trabalho / Chaussures de sécurité / Hoge werkschoenen



S3 SRC



Ref.	Size	Size [cm]	☒	EAN
82-120	39	26	0/10	5907558428698
82-121	40	26.7	0/10	5907558428704
82-122	41	27.3	0/10	5907558428711
82-123	42	28	0/10	5907558428728
82-124	43	28.7	0/10	5907558428735
82-125	44	29.3	0/10	5907558428742
82-126	45	30	0/10	5907558428759
82-127	46	30.7	0/10	5907558428766
82-128	47	31.3	0/10	5907558428773

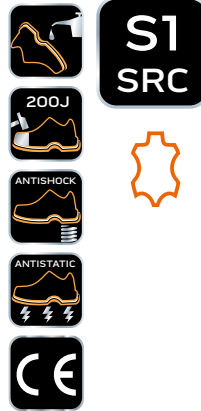
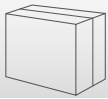

S1 SRC



Ref.	Size	Size [cm]	☒	EAN
82-165-39	39	26	0/10	5907558484069
82-165-40	40	26.7	0/10	5907558484076
82-165-41	41	27.3	0/10	5907558484083
82-165-42	42	28	0/10	5907558484090
82-165-43	43	28.7	0/10	5907558484106
82-165-44	44	29.3	0/10	5907558484113
82-165-45	45	30	0/10	5907558484120
82-165-46	46	30.7	0/10	5907558484137
82-165-47	47	31.3	0/10	5907558484144

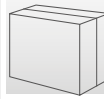

S3 SRC



Ref.	Size	Size [cm]	☒	EAN
82-166-39	39	26	0/10	5907558484151
82-166-40	40	26.7	0/10	5907558484168
82-166-41	41	27.3	0/10	5907558484175
82-166-42	42	28	0/10	5907558484182
82-166-43	43	28.7	0/10	5907558484199
82-166-44	44	29.3	0/10	5907558484205
82-166-45	45	30	0/10	5907558484212
82-166-46	46	30.7	0/10	5907558484229
82-166-47	47	31.3	0/10	5907558484236

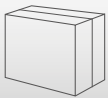

S1P SRA



Ref.	Size	Size [cm]	☒	EAN
82-020	39	26	0/10	5907558415032
82-021	40	26.7	0/10	5907558415049
82-022	41	27.3	0/10	5907558415056
82-023	42	28	0/10	5907558415063
82-024	43	28.7	0/10	5907558415070
82-025	44	29.3	0/10	5907558415087
82-026	45	30	0/10	5907558415094
82-027	46	30.7	0/10	5907558415101
82-028	47	31.3	0/10	5907558421019

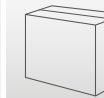

Wkładka do butów

Shoe insert / Einlegesohle / Стелька для обуви / Устілка до черевацик / Talpabetét / Branč / Încălțăminte / Vložka do obuvi / Vložka do topánok / Vložek za čevlje / Batų vidpadiš / Apsavu ieliktņis / Sisetalad / Вложка за обувку / Uložak za cipele / Uložak za obuću / Πάτος παπουτσιών / Plantilla para zapatos / Soletta per scarpe / Palmilha / Insert de chaussure / Inlegzool



Ref.	size [mm]	☒	EAN
82-315	36-40	1/200	5907558495492
82-316	41-47	1/200	5907558495508



Ref.	size	☒	EAN
82-300	universal	0/300	5907558431438



Wkładka do butów

Shoe insert / Einlegesohle / Стелька для обуви / Устілка до черевука / Talpbatét / Branđ de Încălțăminte / Vložka do obuvi / Vložka do toránok / Vložek za čevlje / Batų vidpadiš / Араву иеліктніс / Sisetallad / Вложка за обувку / Uložak za cipele / Uložak za obuću / Πάτος παπουτσιών / Plantilla para zapatos / Soletta per scarpe / Palmilha / Insert de chaussure / Inlegzool

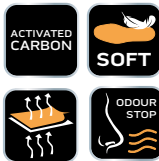

Ref.	Info	☒	EAN
82-302	1 pcs	0/300	5907558431445
82-303	10 pcs	0/30	5907558431421



Ref.	Size	☒	EAN
82-320	38-39	0/200	5907558430578
82-321	40-41	0/200	5907558430585
82-322	42-43	0/200	5907558430592
82-323	44-45	0/200	5907558430608
82-324	46-47	0/200	5907558430615



Ref.	Size	☒	EAN
82-310	38-39	0/200	5907558430523
82-311	40-41	0/200	5907558430530
82-312	42-43	0/200	5907558430547
82-313	44-45	0/200	5907558430554
82-314	46-47	0/200	5907558430561

Skarpety robocze

Working socks / Arbeitssocke / Рабочие носки / Шкарпетка робоча / Munkazokni / Šosetã de lucru / Pracovní ponožka / Pracovné ponožky / Delovna nogavica / Darbinės kojines / Darba zeķes basic / Töösokid / Рабочи чоран / Radne čarape / Radna čarapa / Κάλτσα εργαίας / Calcetín de trabajo / Calza da lavoro / Meias de trabalho / Chaussette de travail / Werksok

GRAPHITE



Ref.	Size	info	☒	EAN
GD019	39-42	long	50/400	5902062997777
GD020	43-46	long	50/400	5902062997784
GD032	39-42	short	50/600	5902062102669
GD033	43-46	short	50/600	5902062102676



Ref.	Size	info	☒	EAN
GD017	39-42	long	50/400	5907558481785
GD018	43-46	long	50/400	5907558481792
GD030	39-42	short	50/600	5907558495294
GD031	43-46	short	50/600	5907558495300

Skarpety robocze

Working socks / Arbeitssocke / Рабочие носки / Шкарпетка робоча / Munkazokni / Šosetã de lucru / Pracovní ponožka / Pracovné ponožky / Delovna nogavica / Darbinės kojines / Darba zeķes basic / Töösokid / Рабочи чоран / Radne čarape / Radna čarapa / Κάλτσα εργαίας / Calcetín de trabajo / Calza da lavoro / Meias de trabalho / Chaussette de travail / Werksok



COTTON 67%
POLYESTER 30%
ELASTAN 3%



Ref.	Size	☒	EAN
82-350	39 - 42	1/60	5907558444605
82-351	43 - 46	1/60	5907558444612



COTTON 67%
POLYESTER 30%
ELASTAN 3%



Ref.	Size	☒	EAN
82-355	39 - 42	1/60	5907558444629
82-356	43 - 46	1/60	5907558444636



COTTON 67%
POLYESTER 30%
ELASTAN 3%



Ref.	Size	☒	EAN
82-360	39 - 42	0/20	5907558444643
82-361	43 - 46	0/20	5907558444650



COTTON 45%
COOLMAX 23%
POLYESTER 22%
POLYAMID 6%
SPANDEX 4%

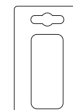

Ref.	Size	☒	EAN
82-365	39 - 42	0/20	5907558463576
82-366	43 - 46	0/20	5907558463583



Rękawice robocze

Working gloves / Arbeitshandschuhe / Перчатки рабочие / Руквици работни / Munkakesztyű / Mănuși de lucru / Pracovní rukavice / Pracovné rukavice / Delovne rokavice / Darbo pirštines / Darba cimdi / Töökindad / Ръкавицу работни / Radne rukavice / Radne rukavice / Γάντια εργαίας / Guantes de trabajo / Guanti da lavoro / Luvas de trabalho / Gants de travail / Werkhandschoenen



LATEX COATED
KAT II
2143X
CE



Ref.	Size	⊠	EAN
97-640-8	8"	10/100	5907558447811
97-640-9	9"	10/100	5907558447828
97-640-10	10"	10/100	5907558447835



LATEX COATED
KAT II
3131X
CE



Ref.	Size	⊠	EAN
97-641-8	8"	10/100	5907558447842
97-641-9	9"	10/100	5907558447859
97-641-10	10"	10/100	5907558447866



LATEX COATED
KAT II
3141X
CE



Ref.	Size	⊠	EAN
97-617-8	8"	10/100	5907558448023
97-617-9	9"	10/100	5907558448030
97-617-10	10"	10/100	5907558448047



2x LATEX COATED
KAT II
3141X
CE



Ref.	Size	⊠	EAN
97-643-8	8"	10/100	5907558447903
97-643-9	9"	10/100	5907558447910
97-643-10	10"	10/100	5907558447927



NITRILE COATED
KAT II
4131X
CE



Ref.	Size	⊠	EAN
97-616-8	8"	10/100	5907558447996
97-616-9	9"	10/100	5907558448009
97-616-10	10"	10/100	5907558448016



NITRILE COATED
KAT II
4131X
CE



Ref.	Size	⊠	EAN
97-642-8	8"	10/100	5907558447873
97-642-9	9"	10/100	5907558447880
97-642-10	10"	10/100	5907558447897



NITRILE COATED
KAT II
4121X
CE



Ref.	Size	⊠	EAN
97-630-8	8"	10/100	5907558448115
97-630-9	9"	10/100	5907558448122
97-630-10	10"	10/100	5907558448139



NITRILE COATED
KAT II
4111X
CE



Ref.	Size	⊠	EAN
97-631-8	8"	10/100	5907558448146
97-631-9	9"	10/100	5907558448153
97-631-10	10"	10/100	5907558448160



anti cut
PU COATED
KAT II
4X43D
CE



Ref.	Size	⊠	EAN
97-609-8	8"	10/100	5907558447934
97-609-9	9"	10/100	5907558447941
97-609-10	10"	10/100	5907558447958



anti cut
NITRILE COATED
KAT II
4X43D
CE



Ref.	Size	⊠	EAN
97-610-8	8"	10/100	5907558447965
97-610-9	9"	10/100	5907558447972
97-610-10	10"	10/100	5907558447989



KAT I
CE



Ref.	Size	⊠	EAN
97-620-8	8"	10/300	5907558448054
97-620-9	9"	10/300	5907558448061
97-620-10	10"	10/300	5907558448078



NITRILE COATED
KAT II
4131X
CE



Ref.	Size	⊠	EAN
97-621-8	8"	10/100	5907558448085
97-621-9	9"	10/100	5907558448092
97-621-10	10"	10/100	5907558448108



Rękawice robocze

Working gloves / Arbeitshandschuhe / Перчатки рабочие / Рукавици работчи / Munkakesztyű / Mänuși de lucru / Pracovní rukavice / Pracovné rukavice / Delovne rokavice / Darbo pirštines / Darba cimdi / Töökindad / Ръкавици работни / Radne rukavice / Radne rukavice / Гάντα εργασιών / Guantes de trabajo / Guanti da lavoro / Luvas de trabalho / Gants de travail / Werkhandschoenen



Ref.	Size	⊠	EAN
97-615	10"	12/120	5907558433982



Ref.	Size	⊠	EAN
97-602	10,5"	12/96	5907558406825



Ref.	Size	⊠	EAN
97-611	10"	0/120	5907558421804



Ref.	Size	⊠	EAN
97-603	10"	12/120	5907558409147
97-604	8"	0/12	5907558407655



Ref.	Size	⊠	EAN
97-605	10"	0/96	5907558412901



Ref.	Size	⊠	EAN
97-606	10"	6/96	5907558412918



Ref.	Size	⊠	EAN
97-690-M	M	10/10	5907558484489
97-690-L	L	10/10	5907558484496
97-690-XL	XL	50/10	5907558484502



Ref.	Size	⊠	EAN
97-691-M	M	100/10	5907558484519
97-691-L	L	100/10	5907558484526
97-691-XL	XL	100/10	5907558484533

Rękawice robocze z magnesem

Working gloves with magnet / Arbeitshandschuhe / Перчатки рабочие с магнитом / Рукавици работчи / Bőr kesztyű / Mänuși de lucru / Pracovní rukavice / Pracovné rukavice / Delovne rokavice / Darbo pirštines / Darba cimdi / Töökindad / Ръкавици работни / Radne rukavice / Radne rukavice / Гάντα εργασιών / Guantes de trabajo / Guanti da lavoro / Luvas de trabalho / Gants de travail / Werkhandschoenen



Ref.	⊠	EAN
GD013	12/120	5907558462401
GD014	12/120	5907558462418

Opaska magnetyczna

Magnetic wristband / Магнитный браслет / Магнетний ремінець / Mágneses zsinór / Bandă magnetică / Magnetický náramek / Magnetický páratok / Magnetni trak / Magnetinis apyrankė / Magnētiskā siksnā / Magnetiline esiriba / Магнитна лента за китка / Magnetska vrpca / Магнетна трака за носење / Μαγνητική ζώνη / Braccialeto magnetico / Pulsera magnética / Pulseira magnética / Bracelet magnétique / Magnetische polsband



Ref.	⊠	EAN
GD012	10/50	5907558462425

Półmaska przeciwpyłowa

Dust half-mask / Staubschutzmaske / Респиратор противопылевой / Респиратор захисний протипилевоий / Portmask / Mască mică protecție praf / Polomaska protiprašná / Respirátor protiprachový / Zaščitna maska / Puskaukê nuo dulkių / Aizsargmaska / Tolmuvastane poolmask / Μασκα αντιοποραχουα / Zašitna maska / Zašitna maska / Ημίμασκα προστασίας / προστασίας από ακόνη / Máscara para polvo / Semimaschera contro polvere / Máscara contra pó / Demi-masque anti-poussière / Stof half-masker



Okulary ochronne

Safety goggles / Schutzbrille / Очки защитные / Окуляри протиоскопичні / Védőszemüveg / Ochelari protecție / Ochranné brýle / Ochranné okuliare / Zaščitna očala / Apsauginiai akiniai / Aizsargbrilles / Kaitseprillid / Очла предпазни / Zašitne naočale / Zastitne naočari / Γαυλιά προστασίας / Gafas protectoras / Occhiali di sicurezza / Óculos de proteção / Lunettes de protection / Beschermingsbril



Gogle ochronne

Protective goggles / Augenschutzbrillen / Защитные очки / Окуляри захисні / Védőszemüveg / Ochelari de protecție / Ochranné brýle / Ochranné okuliare / Zaščitna očala / Apsauginiai akiniai / Aizsargbrilles / Kaitseprillid / Защитни очила / Zašitne gogle / Zašitne naočare / Προστατευτικά γαυλιά / Gafas protectoras / Occhiali protettivi / Óculos de proteção / Lunettes google de protection / Veiligheidsbril



Oszona przeciwdpryskowa

Face protection shield / Splitterschutz / Щиток протиоскопичний / Щиток протиоскопичний / Arcvédő / Ecran protecție față / Clona proti odpryskům / Ochranný štít / Ščitnik za obraz / Apsauginis skydelis veidui / Pretlauskus aizsargmaska / Kaitsevisiir / Предпазен щит / Štitnik za lice / Štitnik za lice / Μάσκα κεφαλής προστασίας από θραύσματα / Máscara protectora facial / Visiera ribaltabile anti scheggia / Proteção / Protecteur anti-éclats / Bescherming tegen tegen slingerende deeltjes



Półmaska silikonowa

Silicon mask / Silikon-Halbmaste / Силиконовая полумаска / Півмаска силіконова / Szilikon félmaszk / Semimascara cu silicon / Silikonová polomaska / Silikonový respirátor / Silikoniska polmaska / Silikonine puskaukè / Silikona pumaska / Silikonist respirator / Силиконова полумаска / Silikoniska polumaska / Silikoniska polumaska / Μάσκα μισού προσώπου από σιλκόνη / Media máscara de sílica / Maschera di protezione / Semi-máscara em silicone / Demi-masque silicone



Ref.	📦	EAN
97-350	0/60	5907558407730

Filtr

Filter / Filter / Фильтр / Фильтр / Szűrő / Filtru / Filtr / Filter / Filter / Filtras / Filtrs / Filter / Филтър / Filtar / Filteri za prašinu / Φίλτρο / Filtra / Filtra per mascherina / Filtra / Filtre / Filter



Ref.	📦	EAN
97-361	50/200	5907558408058

Pochłaniacz

Cartridge / Maskenfilter / Фильтрующий патрон A1 / Фильтр / Szűrő / Absorbant / Pohlcovač / Pohlcovač / Absorbent / Filtras / Absorbētājs / Filter / Адсорбер / Apсорber / Prigušivač / Ανταλλακτικό φίλτρο A1 / Filtra / Cartuccia / Filtra / Absorbeur



Ref.	📦	EAN
97-360	50/200	5907558407747



Ref.	📦	EAN
97-362	50/200	5907558409130

Czapka z daszkiem

Work cap / Schilmütze / Бейсболка рабочая / Бейсболка рабочая / Láthatósági sapka / Sapca cu sozorar / Pracovní kšiltovka / Čiapka so šiltom, pracovná / Delovna kapa s šiltom / Kepure su snapeliu / Darba cepure ar pagu / Nokaga tōōtmūts / Рабочна шапка с нозурка / Radna kapa / Radnička kapa / Καπέλο εργασίας τύπου μπέιζμπολ / Gorra de trabajo / Cappello / Boné de trabalho / Casquette de travail à visière



100% COTTON



Ref.	📦	EAN
97-590	0/50	5907558415728

Pasek

Belt / Gürtel / Ремень / Ремінь / Öv / Curea / opasek / Opasok / Pašček / Dirželis jrankiams / Josta / Rihm / Колан / Pojas / Kaiš / Ζώνη / Cinturón / Cintura / Riem



COTTON 100%

ONE SIZE

130 cm



Ref.	L [cm]	📦	EAN
81-900	130	0/160	5907558431148

Nakolanniki ochrone

Knee protector / Knieschützer / Наколенники защитные / Щитки наколінні захисні / Térdvédő zselés / Genuchierä protectoare / Nákolenky / Chráníč kolien / Ščitniki za kolena / Arpsauga keliams / Celgalu aizsargi / Põlvekaitse / Наколенки / Štitnik za koljena / Štitnik za kolena / Επιγονατίδες προστατευτικές / Rodilleras de protecció / Ginocchiere / Protecção de joelhos / Protège-genoux / Kniebescherming



x2



Ref.	📦	EAN
97-536	6/24	5907558407679



x2

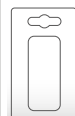

Ref.	📦	EAN
97-535	6/24	5907558419627



Wkładki piankowe na kolana

Knee foam pads / Knieeinlagen aus Schaumstoff / Вставки-наколенники из пеноматериала / Наколінники поліуретанові / Térdelő betét / Insertii de spuma pentru genunchi / Pěnové vložky na kolena / Penasti ščitniki za kolena / Apsauga keliams su putų pagalvėlėmis / Putuplasta ieliktni celgaliam / Vahtplastist põlvekaitismed / Наколенники от пена / Pjenasti štitnik za koljena / Jastučici od pene za kolena / Προσθαφαριούμενες επιγονατίδες από αφρώδες υλικό / Rodilleras de espuma / Ginocchiere / Almofada de espuma para joelho / Inserts de protection en mousse pour genoux / Schuimkniebescherming

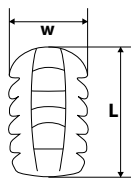

x2

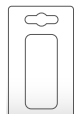

Ref.	W [mm]	L [mm]	Info	EAN
97-530	175	265	0/25	5907558419610

Wkładki przeciwhałasowe

Earplugs / Ohrstöpsel / Противошумные вкладыши / Бөрүкха ("бөрүш") / Földugó pár / Antifoane / zátky do uší / Zátkové chrániče sluchu / Сепки за ушеса / Ausy kaištukai / Ausu aizbāžņi / Kõrvatropid / Антифони, поставяни на ушите / Сепици за уши / Сепови за уши / Πτοασπίδες / Tapones para los oídos / Tappi per le orecchie / Tappões de ouvidos / Bouchons d'oreille / Oordopjes

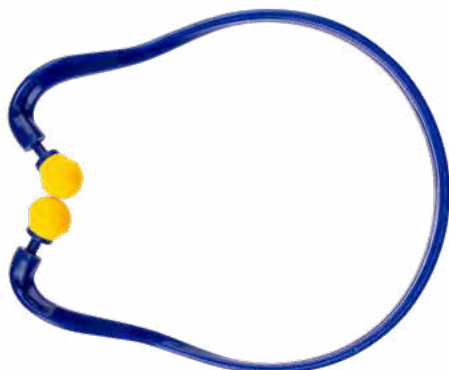

29 dB EN352

Ref.	Info	Info	EAN
97-553	29dB	15/300	5907558481655



32 dB EN352

Ref.	Info	Info	EAN
97-554	29dB	30/600	5907558481662

Wkładki przeciwhałasowe

Earplugs / Ohrstöpsel / Противошумные вкладыши / Бөрүкха ("бөрүш") / Földugó pár / Antifoane / zátky do uší / Zátkové chrániče sluchu / Сепки за ушеса / Ausy kaištukai / Ausu aizbāžņi / Kõrvatropid / Антифони, поставяни на ушите / Сепици за уши / Сепови за уши / Πτοασπίδες / Tapones para los oídos / Tappi per le orecchie / Tappões de ouvidos / Bouchons d'oreille / Oordopjes

x10 EN352 CE



Ref.	Size	Info	Info	EAN
97-550	9/11	33dB	25/500	5907558419634

x10 EN352 CE

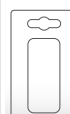

Ref.	Size	Info	Info	EAN
97-555	5/16	29dB	40/800	5907558419641

x1000 (500 pairs) 38 dB EN352



Ref.	Info	Info	EAN
97-552	38dB	0/20	5907558481648

38 dB x1000 (500 pairs) EN352



Ref.	Info	Info	EAN
97-551	38dB	0/4	5907558481631





ELEKTRONARZĘDZIA I AKCESORIA

power tools
and accessories

електроінструмент
та аксесуари

GRAPHITE

POWER IN YOUR HANDS

3

YEARS
WARRANTY

GRAPHITE

GRAPHITE



18V
Li-Ion
4.0Ah

ENERGY+
system

NEO GRAPHITE
TOOLS

Marka **GRAPHITE** zapewnia pełną dostępność części zamiennych oraz materiałów eksploatacyjnych dla urządzeń i elektronarzędzi. Dzięki temu urządzenia mogą być sprawne przez długi czas.

We ensure constant availability of spare parts and consumable materials for devices and power tools. Therefore, the **GRAPHITE** power tools stay operational for years.

Забезпечуємо постійну доступність запчастин та витратних матеріалів для обладнання та електроінструменту. Завдяки цьому електроінструмент GRAPHITE залишається справним протягом довгих років.

GRAPHITE to:

- ▶ szeroki asortyment wysokiej jakości elektronarzędzi i akcesoriów
- ▶ ważny i wiodący element marki stanowi system Energy+
- ▶ elektronarzędzia przeznaczone do intensywnego użytkowania, przy obciążeniach bliskich profesjonalnym
- ▶ produkty z optymalnym zestawem cech: wytrzymałe, ergonomiczne, o mocnych silnikach

GRAPHITE is:

- ▶ a wide range of high quality power tools and accessories
- ▶ an important and leading element of the brand is the Energy+ System
- ▶ power tools designed for intensive semi-professional use
- ▶ products with optimum set of features: durable, ergonomic, with powerful motors

GRAPHITE це:

- ▶ широкий асортимент високоякісного електроінструменту та аксесуарів до нього
- ▶ важливим та провідним елементом бренду є система Energy +
- ▶ електроінструмент, призначений для інтенсивного використання при навантаженнях, наближених до професійних
- ▶ продукти з оптимальним набором якостей: міцні, з потужними двигунами та ергономічною конструкцією

ZAPRASZAMY NA KANAŁY MARKI GRAPHITE W MEDIACH SPOŁECZNOŚCIOWYCH

COME AND BROWSE GRAPHITE SOCIAL MEDIA CHANNELS

ЗАПРОШУЄМО НА КАНАЛИ МАРКИ GRAPHITE У СОЦІАЛЬНИХ МЕРЕЖАХ



GRAPHITE

Informacje o nowościach produktowych, porady oraz VIDEO



Information on new products, advice and VIDEOS

Інформація про нові продукти, події, поради та відео

YouTube
GRAPHITEmov

VIDEO produktowe, porównania i testy produktów w wielu wersjach językowych



Product related VIDEOS, product comparisons and tests in multiple language versions

ВІДЕО про продукцію, порівняння продукції та тести на декількох мовах



QR-code obok produktu to dedykowane dla niego części zamienne

Scan the QR code to purchase spare parts for each GRAPHITE tool

QR-код поряд із продуктом присвячений

graphite.pl

Wiertarko-wkrętarka akumulatorowa

Cordless drill / Akkuboehrschrauber / Дрель-шуруповерт аккумуляторная / Дрель-шуруповерт аккумуляторный / Akkus ütvefűró / Vormasina-surubelmita cu acumulator / Akumulátorový vrtačka-šroubovák / Akumulátorový vrtací skrutkovač / Akumulatorski vrtalnik-vijačnik / Akumuliatorinis gręžtuvas - sukutvas / Akumulatora urbjmašina-skrūvgriezis / Akutrell / Аккумуляторен пробивен винтоверт / Akumulatorska bušilica - izvijač / Akumulatorska bušilica - odvijač / Εναρφαρριζόμενο βραχάνο-κατσάβιδο / Taladradora atornilladora a batería / Trapano avvitatore a batteria con percussione / Aparafuradora de batería / Perceuse-visseuse à batterie / Accu boor-draaimachine

ENERGY+
system

NEO GRAPHITE



2 - 13 mm



2x 18V 2Ah
Li-Ion



I: 0-350 min⁻¹
II: 0-1250 min⁻¹



1-19
+ drilling



35 Nm



55 Nm



Ref.	[kg]	☒	EAN
58G006-SET2	5,02	0/4	5902062503640

ENERGY+
system

NEO GRAPHITE



2 - 13 mm



18V 2Ah
Li-Ion



I: 0-500 min⁻¹
II: 0-1700 min⁻¹



1-16
+ drilling



38 Nm



58 Nm



Ref.	[kg]	☒	EAN
58G019-SET1	4,56	0/4	5902062503664

ENERGY+
system

NEO GRAPHITE



2 - 13 mm



18V 2Ah
Li-Ion



I: 0-500 min⁻¹
II: 0-1700 min⁻¹



1-16
+ drilling



38 Nm



58 Nm



Ref.	[kg]	☒	EAN
58G020-SET2	5,06	0/4	5902062503688

Wiertarko-wkrętarka akumulatorowa

Cordless drill / Akkubohrschrauber / Дрель-шуруповерт аккумуляторная / Дрель-шуруповерт аккумуляторный / Akkus ütvefűró / Vormasina-surubelnita cu acumulator / Akumulátorová vrtačka-šroubovák / Akumulátorový vrtací skrutkovač / Akumulatorski vrtalnik-vijačnik / Akumulatoriinis gręžtuvas - suktuvas / Akumulatora urbjmašina-skrūvgriezis / Akutrell / Аккумуляторен пробоеен винтоверт / Akumulatorska bušilica - izvijač / Akumulatorska bušilica - odvijrač / Επαναφορτιζόμενο βραπάνο-κατάρτιδο / Taladradora atornilladora a batería / Trapano avvitatore a batteria con percussione / Aparafuradora de batería / Perceuse-visseuse à batterie / Accu boor-draaimachine

ENERGY+
system

NEO GRAPHITE

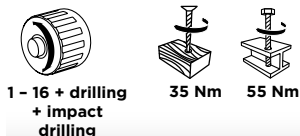
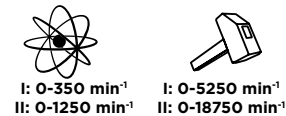
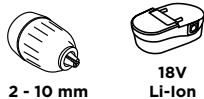

Ref.	[kg]	⊠	EAN
58G010	1,3	0/5	5902062035387



ENERGY+
system

NEO GRAPHITE

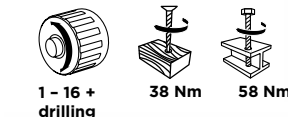

Ref.	[kg]	⊠	EAN
58G019	1,2	0/5	5902062045942



ENERGY+
system

NEO GRAPHITE

NEO
TOOLS

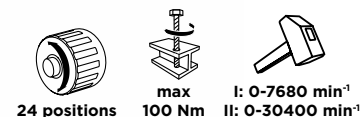
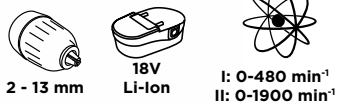

Ref.	[kg]	⊠	EAN
04-616	1,56	1/5	5907558484595

Wiertarko-wkrętarka sieciowa

Electric screwdriver / Netzschrauber / Дрель-шуруповерт электрическая / Шрубоверт мережевий / Elektromos csavarhúzó / Surubelnita electrica / Elektrická vrtačka / Elektrický skrutkovač / Električni vijačnik / Elektrinis suktuvas / Tikla skrūvgriezis / Elektriline krivikeeraja / Мрежова бормашина / Električna bušilica / Električna bušilica / Ηλεκτρικό βραπάνο-κατάρτιδο / Atornillador eléctrico / Avvitatore elettrico / Máquina de pôr parafusos / Visseuse réseau / Elektrische boormachine

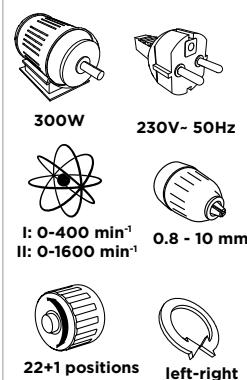

Ref.	[kg]	⊠	EAN
58G793	1,39	1/4	5902062087805

Wiertarka udarowa

Impact drill / Bohrhämmer / Дрель ударная / Дрель ударный / Ütvefűró / Perforator de lovit / Přiklepová vrtačka / Přiklepová vrtačka / Udarni vrtalnik / Gręžtuvas su kalimu / Sitiena urbjmašina / Löökdrell / Бормашина ударна / Udarata bušilica / Udarata busilica / Κρουστικό βράπανο / Taladro de impacto / Trapano a percussione / Berbequim de impacto / Perceuse à choc / Slagboormachine

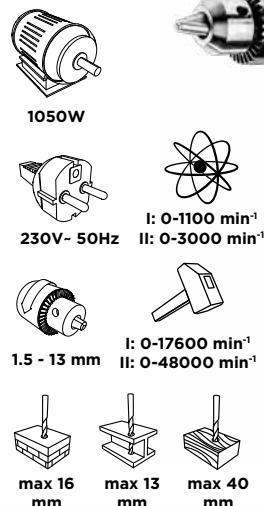

Ref.	[kg]	⊠	EAN
58G722	5,4	0/4	5902062024251

Grzechotka akumulatorowa

Cordless ratchet / Schnurlöse Ratsche / Аккумуляторная трещотка / Аккумуляторна тріскачка / Akkus racsni / Clichet fără fir / Akumulátorová ráčna / Akumulátorová račia / Akumulatorska vrtavka / Akumulatoriinis reketas / Bezvadu tarkšķis / Juhtmeta ratas / Аккумуляторна трещотка / Bežična čegrtaljka / Аккумуляторна чергталъна / Αιούρητη κατάρτινα / Carraca inalámbrica / Cricchetto a batteria / Catraca sem fio / Cliquet sans fil / Draadloze ratel

ENERGY+
system

NEO GRAPHITE

NEO
TOOLS

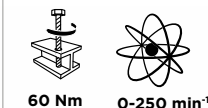

Ref.	[kg]	⊠	EAN
04-603	0,9	1/20	5907558465525

Zakrętaraka akumulatorowa ENERGY+

Cordless driver / Akku-Schraubmaschine / Гайковерт аккумуляторный / Мутроверт аккумуляторный / Akkus ütvecsavarozó / Inchizător de acumulator / Akumulátorový šroubovák / Akumulátorový šroubovák / Akumulatorski vrtalnik / Akumulatorinis suktivas / Akumulatora uzvāznis / Кеетмерпуур / Ударен гайковерт / Akumulatorski zavijač / Akumulatorski navojni čep / Εναρφορτιζόμενο καταβίθι / Dispositivo de cierre a batería / Avvitatore a batteria ad impulsi / Máquina de travar com bateria / Visseuse à batterie / Accu schroefmachine

ENERGY+
system

NEO GRAPHITE



6.35mm (1/4") 18V Li-Ion

0-2200 min⁻¹ 180 Nm

Ref.	[kg]	⊠	EAN
58G012	1,2	0/5	5902062035400

ENERGY+
system

NEO GRAPHITE



BRUSHLESS MOTOR



6.35mm (1/4")



18V Li-Ion



I. 0-1000 min⁻¹
II. 0-1800 min⁻¹
III. 0-2700 min⁻¹



I. max 80 Nm
II. max 120 Nm
III. max 200 Nm



Ref.	[kg]	⊠	EAN
58G024	1,1	0/5	5902062059765

Klucz udarowy akumulatorowy ENERGY+

Impact wrench / Schlagschlüssel / Ключ ударный / Мутроверт ударный / Ütvecsavarozó / Cheie cu percúție / Rázový utahovák / Priklepový klúč / Udarni vijačnik / Atskélimo plaktukas / Sitama atslēga / Löökvõti / Ударен ключ / Udarni ključ / Pneumatski ključ / Κλειδί κρούσης / Llave de impacto / Avvitatore ad impulsi / Chave de impacto / Clef à chocs / Slagsleutel

ENERGY+
system

NEO GRAPHITE



12.7 mm (1/2") 18V Li-Ion

0-2000 min⁻¹ 180 Nm

Ref.	[kg]	⊠	EAN
58G018	1,8	0/5	5902062045935

ENERGY+
system

NEO GRAPHITE



BRUSHLESS MOTOR



12.7 mm (1/2")



18V Li-Ion



I. 0-1000 min⁻¹
II. 0-1800 min⁻¹
III. 0-2700 min⁻¹



I. max 220 Nm
II. max 250 Nm
III. max 300 Nm



Ref.	[kg]	⊠	EAN
58G028	1,8	1/5	5902062059796

ENERGY+
system

NEO GRAPHITE



BRUSHLESS MOTOR



12.7 mm (1/2")



18V Li-Ion



I. 0-1600 min⁻¹
II. 0-2100 min⁻¹
III. 0-2600 min⁻¹



I. max 200 Nm
II. max 320 Nm
III. max 450 Nm



Ref.	[kg]	⊠	EAN
58G038	1,25	0/5	5902062089076

NEO
TOOLS

ENERGY+
system

NEO GRAPHITE



BRUSHLESS MOTOR



12.7 mm (1/2")



18V Li-Ion



I. 0-1000 min⁻¹
II. 0-1200 min⁻¹
III. 0-1800 min⁻¹



I. 560 Nm
II. 680 Nm
III. 1100 Nm



Ref.	[kg]	⊠	EAN
04-618	3,01	1/4	5907558495973

Klucz udarowy

Impact wrench / Schlagschlüssel / Ключ ударный / Мутроверт ударный / Ütvecsavarozó / Cheie cu percucie / Rázový utahovák / Prikleponý ključ / Udarni vijčnik / Sitama atslēga / Celniecības jēns / Löökvõti / Ударен ключ / Udarni ključ / Pneumatski ključ / Κλειδί κρούσης / Llave de impacto / Avvitatore ad impulsi / Chave de impacto / Clef à chocs

NEO
TOOLS

3 YEARS WARRANTY
10 YEARS SHAFT PARTS WARRANTY

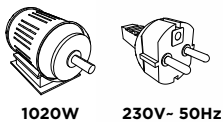

Ref.	[kg]	⊠	EAN
04-720	3,5	1/4	5907558483673

Szlifierka kątowa akumulatorowa ENERGY+

Cordless angle grinder / Winkelschleifer / Аккумуляторная угловая шлифовальная машина / Шлифмашина кутова (болгарка) / Akkus sarkocsizoló / Masina de slefuit unghiulara / Úhlová bruska / Uhlová bruska / Kotni brusilnik / Kampinis šlifjuoklis / Leŕka slípmášina / Nurkljihvija / Ёлоушлѝф / Kutna brusilica / Γωνιακό τριβείο / Amoladora angular / Smerigliatrice angolare / Disco de limar p. cantos / Meuleuse d'angle / Versteckschuurmachine

ENERGY+
system
NEO GRAPHITE



Ref.	[kg]	⊠	EAN
58G026	1,7	1/4	5902062059772

ENERGY+
system
NEO GRAPHITE

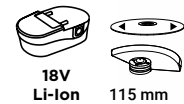

Ref.	[kg]	⊠	EAN
58G003	1,5	1/4	5902062035318

Szlifierka kątowa

Angle grinder / Winkelschleifer / Шлифмашина угловая / Шлифмашина нарижна / Sarkocsizoló / Mašiná unghiulará de slefuit / Bruska úhlová / Brúska uhlová / Kotni brusilnik / Kampinis šlifjuoklis / Leŕka slípmášina / Nurkljihvija / Ёлоушлѝф / Brusilica kutna / Brusilica ugaona / Γωνιακό τριβείο / Amoladora angular / Smerigliatrice angolare / Disco de limar p. cantos / Meuleuse d'angle / Versteckschuurmachine

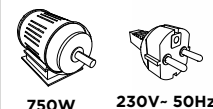

Ref.	[kg]	⊠	EAN
59G175	2,08	1/6	5907558480740

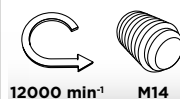
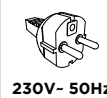
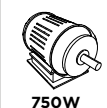

Ref.	[kg]	⊠	EAN
59G063	2,5	1/6	5902062024336

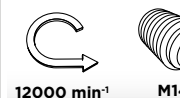
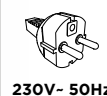
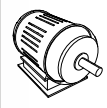

Ref.	[kg]	⊠	EAN
59G087	2,5	1/6	5902062024343

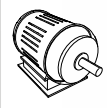

Ref.	[kg]	⊠	EAN
59G208	6,9	1/2	5902062034663

Szlifierka mimośrodowa akumulatorowa ENERGY+

Cordless orbital sander / Exzenterschleifmaschine / Аккумуляторная эксцентриковая шлифовальная машина / Шліфмашина ексцентрикова / Akkus excentercsiszoló / Masina de slefuit excentrica / Excentrická bruska / Excentrická brúška / Ekscentrični brusilnik / Ekscentrinis šlijfuoklis / Ekscentra slīpmašīna / Ekscentriklihvija / Шліфмашина ексцентрична / Vibracijska bušilica / Екцентро трибеџо / Lijadora excéntrica / Levigatrice orbitale / Disco de limar / Meuleuse excentrique / Excenter schuurmachine

ENERGY+
system

NEO GRAPHITE

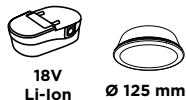

18V
Li-Ion Ø 125 mm



I. 5000 min⁻¹
II. 7000 min⁻¹
III. 9000 min⁻¹



I. 10000 min⁻¹
II. 14000 min⁻¹
III. 18000 min⁻¹



2,7 mm



Ref.	[kg]	⊠	EAN
58G014	1,1	1/4	5902062035424

Szlifierka mimośrodowa

Orbital sander / Exzenterschleifmaschine / Эксцентриковая шлифовальная машина / Шліфмашина ексцентрикова / Excentercsiszoló / Masina de slefuit excentrica / Excentrická bruska / Excentrická brúška / Ekscentrični brusilnik / Ekscentrinis šlijfuoklis / Ekscentra slīpmašīna / Ekscentriklihvija / Шліфмашина ексцентрична / Vibracijska bušilica / Екцентро трибеџо / Lijadora excéntrica / Levigatrice orbitale / Disco de limar / Meuleuse excentrique / Excenter schuurmachine



Ø 125 mm

300W



7000-
13000 min⁻¹



1 mm



Ref.	[kg]	⊠	EAN
59G348	1,2	1/8	5902062087881

Urządzenie wielofunkcyjne

Multi-function tool / Mehrfunktionsgerät / Многофункциональный инструмент / Багатофункційний пристрій / Többfunkciós berendezés / Dispozitiv multifuncțional / Multifunkční zařízení / Multifunkčné zariadenie / Večfunkcijska naprava / Daugiafunkcinis įrankis / Daudzfunkcionālā iekārta / Multifunktsionaalne seade / Мультифункционално устройство / Višenamjenski uređaj / Višefunkcionalni uređaj / Εργαλείο πολλαπλών χρήσεων / Dispositivo multifunción / Dispositivo multifunzione / Dipositivo multifuncional / Appareil multifonction / Multifunctioneel toestel

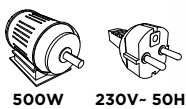

500W 230V-50Hz



8000-
16000 min⁻¹



5°



Ref.	[kg]	⊠	EAN
59G025	1,1	1/4	5902062087836

Urządzenie wielofunkcyjne akumulatorowe ENERGY+

Multi-function tool / Mehrfunktionsgerät / Многофункциональный инструмент / Багатофункційний пристрій / Többfunkciós berendezés / Dispozitiv multifuncțional / Multifunkční zařízení / Multifunkčné zariadenie / Večfunkcijska naprava / Daugiafunkcinis įrankis / Daudzfunkcionālā iekārta / Multifunktsionaalne seade / Мультифункционално устройство / Višenamjenski uređaj / Višefunkcionalni uređaj / Εργαλείο πολλαπλών χρήσεων / Dispositivo multifunción / Dispositivo multifunzione / Dipositivo multifuncional / Appareil multifonction / Multifunctioneel toestel

ENERGY+
system

NEO GRAPHITE



18V
Li-Ion



5000-
20000 min⁻¹



3°



Ref.	[kg]	⊠	EAN
58G013	1,8	1/4	5902062035417

Polerka

Polisher / Polierrmaschine / Полировальная машина / Машина полирувальна / Polírozógép / Masina de lustruit / Leštička / Leštička / Polirka / Poliravimo staklės / Pālēšanas mašīna / Poleerija / Машина за полиране / Aparat za poliranje / Polir mašina / Μηχανή σπλινδμάτος / Pulidora / Lucidatore / Aparelho polidor / Polisseuse / Polijstmaschine

ENERGY+
system

NEO GRAPHITE

NEO
TOOLS

3
YEARS
WARRANTY

10
YEARS
WARRANTY

NEO
TOOLS

3
YEARS
WARRANTY

10
YEARS
WARRANTY



BRUSHLESS
MOTOR



18V
Li-Ion

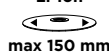

max 150 mm



800- 2300 min⁻¹



M14



Ref.	[kg]	⊠	EAN
04-602	2,8	1/4	5907558465518



710W 230V-50Hz

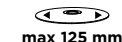

max 125 mm



2000- 4600 min⁻¹



6 m



Ref.	[kg]	⊠	EAN
04-700	2,7	1/6	5907558467994

Opalarka akumulatorowa ENERGY+

Cordless Heat Gun / Schnurlose Heißluftpistole / Аккумуляторная тепловая пушка / Аккумуляторная тепловая гармата / Akkus hólégfúvó / Arma de càldura fàrà fir / Akumulátorová tepelná pistole / Akumulátorová tepelná pištoľ / Brežični toplotni pištoľ / Akumulatorinis šilumos pistoletas / Bezvada karstuma pistole / Juhtmeta soojuspistol / Безжичен топлинен пистолет / Bežični toplinski pištoľ / Безжични топлинни пуштолъ / Πιστόλι θερμότητας χωρίς καλώδιο / Pistola de calor sin cuerda / Pistola termica a batteria / Pistola de calor sem fio / Pistolet à chaleur sans fil

ENERGY+
system

NEO GRAPHITE



Ref.	[kg]	⊠	EAN
58G082	0,6	1/5	5902062503497



18V
Li-Ion



200 l/min



550°C

Pistolet klejowy ENERGY+

Glue gun / Leimpistole / Пистолет клеевой / Пистолет клеїєвий / Ragasztópisztoly / Pistol de lipit / Lepící pistole / Pištoľ lepiaca / Lepilna pištoľ / Klijų pistoletas / Limes pistole / Liimpistol / Пистолет за силикон / Pištoľ za plastiku / Pistoľ za plastiku / Πιστόλι θερμοκόλλησης / Pistola surtidora de pegamento / Pistola incollante / Pistola p. cola / Pistolet à colle / Lijmpistol

ENERGY+
system

NEO GRAPHITE



18V
Li-Ion



Ø 11 mm



3 min



Ref.	[kg]	⊠	EAN
58G040	0,4	1/5	5907558480078

Opalarka

Hot air gun / Sengmaschine / Термофен / Фен / Hólégfúvó / Masina de parlit / Opalovací pistole / Opalovací pištoľ / Fen / Techninis fenas / Celtniecības fēns / Куурапухур / Пистолет за зорещ въздух / Puhala vrućeg zraka / Fen / Πιστόλι θερμού αέρα / Decaparador por aire caliente / Pistola ad aria calda / Soprador de ar quente / Décapeur thermique / Verfstripper



2000W



230V - 50Hz



I: 300 l/min
II: 150 l/min
III: 500 l/min



I: 25°C
II: 350°C
III: 550°C



Ref.	[kg]	⊠	EAN
59G522	1,9	0/5	5902062595225



2000W



230V - 50Hz



I: 350 l/min
II: 350 l/min
III: 500 l/min



I: 50°C
II: 50-550°C
III: 50-550°C



Ref.	[kg]	⊠	EAN
59G526	0,74	1/5	5902062086747

NEO
TOOLS

3
YEARS
WARRANTY

10
YEARS
SPARE PARTS
WARRANTY



2000W



230V - 50Hz



I: 300 l/min
II: 500 l/min



I: 350°C
II: 550°C



Ref.	[kg]	⊠	EAN
59G523	1,0	1/10	5902062086730



2000W



230V - 50Hz



I: 350 l/min
II: 350 l/min



300-500 l/min



Ref.	[kg]	⊠	EAN
04-710	0,77	1/5	5907558470550



Latarka akumulatorowa ENERGY+

Cordless flashlight / Taschenlampe / Аккумуляторный фонарь / Лихтарик / Akkus lámpa / Lanterna / Bateria / Lampa / Svetilka / Žibintuvēlis / Lukturis / Pöleti / Фенерче / Baterijska lampa / Lampa / Φακός / Linterna de mano / Torcia / Lanterna / Torche / Zaklamp

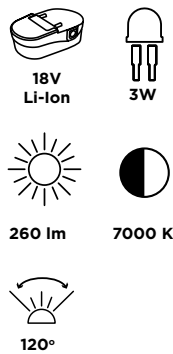

Ref.	[kg]	⊠	EAN
58G007	0,3	1/10	5902062035356

Przecinarka do metalu

Portable cut-off saw / Metall-Trennmaschine / Пила по металлу / Пилка монтажна / Fémdaraboló / Aparat portabil de debitat în metale / Rezačka kovu / Rezačka na kov / Rezalnik kovine / Metalo pjūklas / Metāla griezējs / Metālisaepīnk / Секач за метал / Rezalica za metal / Sekaç za metal / Πριόνι μετάλλου / Cortador para metal / Troncatrice per metallo / Cortador p. metal / Tronçonneuse à métal / Metaalknipper

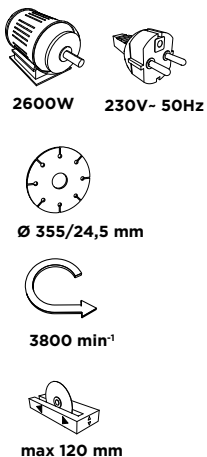

Ref.	[kg]	⊠	EAN
59G873	19	0/1	5902062504890

Pilarka szablowa akumulatorowa ENERGY+

Sabre saw / Motorstichsäge / Сабельная пила / Пилка шабельна / Szablyafűrész / Ferästräu sabie / Šavlová pila / Chvostová pila / Sabljasta žaga / Tiesinis pjūklas / Zobenzägis / Saabelsaag / Саблен трион / Sabljasta pila / Sabljasta testera / Σαβλόσαγα / Sierra de vaivén / Sega universale / Serra de sabre / Scie à sabre / Sabelzaag



Ref.	[kg]	⊠	EAN
58G017	1,8	0/5	5902062035928

Pilarka szablowa

Sabre saw / Motorstichsäge / Сабельная пила / Пилка шабельна / Mini szűrőfűrész / Ferästräu sabie / Šavlová pila / Chvostová pila / Sabljasta žaga / Tiesinis pjūklas / Zobenzägis / Saabelsaag / Саблен трион / Sabljasta pila / Sabljasta testera / Σαβλόσαγα / Sierra de vaivén / Mini sega a gattuccio / Serra de sabre / Scie à sabre / Sjabelzaag

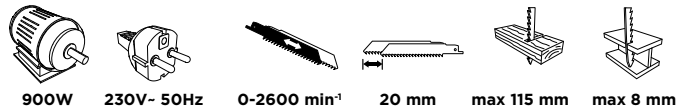

Ref.	[kg]	⊠	EAN
58G971	3,1	0/6	5902062015716

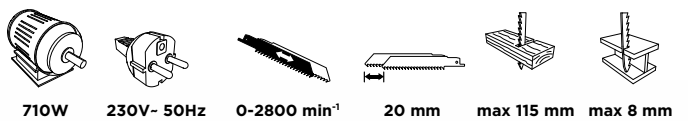

Ref.	[kg]	⊠	EAN
58G961	2,4	1/6	5902062103093

Szlifierka stołowa

Bench grinder / Tischschleifmaschine / Машина шлифовальная настольная / Шліфмашинка верстатна / Kőszögűgép / Masina de slefuit de banc / Stolní bruska / Stolová bruska / Namizni brusilnik / Stacionarus galgstuvas / Galda slīpmašīna / Lauakäi / Настолен абрухт / Stolna brusilica / Stona brusilica / Επιτραπέζιο τριβείο / Amoladora de banco / Smerigliatrice da banco / Disco de limar de mesa / Meuleuse d'établi / Tafelschuurmachine

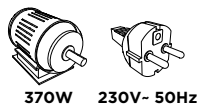

370W 230V - 50Hz



12,7/150 mm

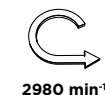

2980 min⁻¹



Ref.	[kg]	☒	EAN
59G383	11,1	0/1	5902062593832



Kompresor akumulatorowy

Inflator with accessories / Akku-Kompressor mit Zubehör / Компрессор аккумуляторный с оснасткой / Компрессор аккумуляторный з принадлежностями / Léggompresszor tartozékokkal / Compresor de cumulator cu accesorii / Akumulátorový kompresor s príslušenstvom / Akumulátorový kompresor z príslušenstvom / Akumulatorski kompresor z opremo / Automobilinis kompresorius su įranga / Akumulatora kompresors ar piederumiem / Akukompressor koos tarvikutega / Аккумуляторен компресор с оборудване / Akumulatorski kompresor s opremom / Baterijski akumulator s priborom / Συμπιεστής επαναφορτιζόμενος με βοηθητικά εξαρτήματα / Compresor a bateria con accesorios / Compresore a batteria con accessori / Compresor de ar para bateria com acessórios / Compresseur à batterie avec accessoires / Batterijcompressor met accessoires



18V Li-Ion



7 bar



Ref.	[kg]	☒	EAN
58G041	0,8	1/5	5907558480085



18V Li-Ion



max 8 bar



4300 min⁻¹

14 l/min

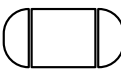

3.8 L



Ref.	[kg]	☒	EAN
04-620	5,68	1/2	5907558495980

Głośnik Bluetooth z funkcją radia

Multimedia speaker / Multimedia-Lautsprecher / Мультимедийная колонка / Мультимедійний динамік / Multimedia hangszóró / Difuzor multimedia / Multimediální reproduktor / Multimediálny reproduktor / Multimedijski zvočnik / Multimedijs garsiakalbis / Multimedijski skaļrunis / Multimediaalkölar / Мультимедийен високоговорител / Multimediální zvučnik / Multimedijski zvučnik / Ηχείο πολυμέσων / Altavoz multimedia / Altoparlante multimediale / Altfalante multimedia / Haut-parleur multimedia



4500 mAh

BT AUX FM USB SD MP3 IP65



Ref.	[kg]	☒	EAN
57G100	0,6	0/20	5902062045911

Adapter USB - latarka LED ENERGY+

USB adapter - LED flashlight / USB-adapter - LED-taschenlampe / Переходник USB - фонарик LED / Adapter USB — лічмак LED / USB adapter - LED lámpa / Adaptor USB - lanternă LED / USB adapter - LED svítilna / USB adaptér - LED baterka / Adapter USB - svetilka LED / Jungtis USB - žibintuvėlis LED / USB adapters - LED lukuris / USB-adapter - LED-taskular / USB адаптор - LED фенер / Adapter USB - LED svjetiljka / USB adapter - LED lamp / Φορητός φορτιστής με USB και φακό LED / Adaptador USB - linterna LED / Adattatore USB - torcia elettrica LED / Adaptateur USB - torche LED / USB adapter - LED zaklamp



18V Li-Ion



1W



Ref.	[kg]	☒	EAN
58G025	0,11	1/50	5907558480092

Torba na elektronarzędzia ENERGY+

Power tool bag / Werkzeugtasche / Сумка для электроинструмента / Торба інструментальна / Gértartó táská / Geanta scule / Brašna na nářadí / Taška na montérská / Torba za orodje / Krepšys įrankiams / Instrumentu soma / Tööriistakott / Чанта за инструменти / Torba za alat / Torba za alat / Κάδος για εργαλεία / Bolsa para herramientas / Borsa in tela / Saco p. ferramentas / Sac à outils / Gereedschapstas

18,5L
Poliester

18.5 l,
46x24x45 cm



Ref.	[kg]	☒	EAN
58G092	1.7	0/4	5902062506801

Akumulator systemu ENERGY+

Battery / Akkumulator / Аккумуляторная батарея / Аккумулятор / Akkumulátor / Acumulator / Akumulátor / Akumulátor / Аккумуляторная батарея / Akumulatorių / Akku / Аккумулятор / Akumulator / Akumulator / Ηλεκτρικός συσσωρευτής / Bateria / Batteria / Bateria / Batterie / Accu



Ref.	[Ah]	☒	EAN
58G001	2.0	0/10	5902062035295
58G004	4.0	0/10	5902062035325
58G086	6.0	0/20	5902062501158

Ładowarka do akumulatorów ENERGY+

GRAPHITE ENERGY+ battery charger / Akku-Ladegerät / Зарядное устройство системы GRAPHITE ENERGY+ / Зарядний пристрій для акумуляторів / Töltő / Incarcator pentru acumulatori / Nabiječka baterij / Nabijačka akumulatora / Polnilnik za akumulatorje / Akumulatorių įkroviklis / Akumulatoru lādētājs / Akulaadija / Зарядно устройство за акумулаторите / Punjač za akumulatore / Punjač za akumulator / Φορτιστής / Cargadora para baterías / Carica batterie / Carregador de baterias / Chargeur à batteries / Accuoplader



Ref.	[Ah]	☒	EAN
58G002	2.3	0/8	5902062035301
58G085	2x 3	0/10	5902062501141



Wiertła do metalu

HSS drills / Metallbohrer / Сверла по металлу / Сверла по металу / Csigafúró / Burghie pentru metale / Vrtáky do kovu / Vrtáky do kovu / Svedri za kovino / Grąztaï metalui / Urbis metalám / Metallpuur / Сврла за метал / Svrdla za metal / Burgija za metal / Τρυπάνια μετάλλου / Brocas para metal / Punta per metallo / Brocas p. metal / Forêts à métal / Boren voor metaal

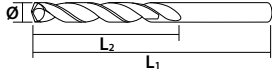
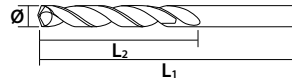

Ref.	Ø [mm]	L1 [mm]	L2 [mm]	☐	☒	EAN
55H010	2.0	46	24	125/500	5902062997074	
55H013	2.5	57	30	125/500	5902062997104	
55H014	3.0	61	33	125/500	5902062997111	
55H015	3.2	65	36	125/500	5902062997128	
55H016	3.5	70	39	125/500	5902062997135	
55H017	3.8	75	43	125/500	5902062997142	
55H018	4.0	75	43	125/500	5902062997159	
55H019	4.2	75	43	120/480	5902062997166	
55H020	4.5	80	47	120/480	5902062997173	
55H021	4.8	86	52	120/480	5902062997180	
55H022	5.0	86	52	120/480	5902062997197	
55H024	5.5	93	57	120/480	5902062997210	
55H025	6.0	93	57	120/480	5902062997227	
55H026	6.5	101	63	120/480	5902062997234	
55H027	7.0	101	63	75/300	5902062997241	
55H029	8.0	117	75	75/300	5902062997265	
55H030	8.5	117	75	75/300	5902062997272	
55H031	9.0	125	81	75/300	5902062997289	
55H033	10.0	133	87	50/200	5902062997302	
55H034	10.2	133	87	50/200	5902062997319	
55H035	10.5	133	87	50/200	5902062997326	
55H036	11.0	142	94	50/200	5902062997333	
55H038	12.0	151	101	50/200	5902062997357	
55H039	12.5	151	101	45/180	5902062997364	
55H040	13.0	151	101	45/180	5902062997371	



Ref.	Ø [mm]	L1 [mm]	L2 [mm]	☐	☒	EAN
57H010	1.0	34	12	5	20/200	5902062570109
57H012	1.5	40	18	5	20/200	5902062570123
57H014	2.0	49	24	5	20/200	5902062570147
57H015	2.2	53	27	3	20/200	5902062570154
57H016	2.4	57	30	3	20/200	5902062570161
57H018	2.5	57	30	3	20/200	5902062570185
57H020	3.0	61	33	1	20/200	5902062570208
57H022	3.2	65	36	1	20/200	5902062570222
57H023	3.5	70	39	1	20/200	5902062570239
57H024	4.0	75	43	1	20/200	5902062570246
57H026	4.2	75	43	1	20/200	5902062570260
57H028	4.5	80	47	1	20/200	5902062570284
57H030	4.8	86	52	1	20/200	5902062570307
57H032	5.0	86	52	1	20/200	5902062570321
57H034	5.2	86	52	1	20/200	5902062570345
57H036	5.5	93	57	1	20/200	5902062570369
57H038	6.0	93	57	1	20/200	5902062570383
57H040	6.5	101	63	1	20/200	5902062570406
57H042	7.0	109	69	1	20/200	5902062570420
57H044	7.5	109	69	1	20/200	5902062570444
57H046	8.0	117	75	1	20/200	5902062570468
57H048	8.5	117	75	1	20/200	5902062570482
57H050	9.0	125	81	1	20/200	5902062570505
57H052	9.5	125	81	1	20/200	5902062570529
57H054	10.0	133	87	1	20/200	5902062570543
57H055	10.2	133	87	1	20/200	5902062570550
57H056	10.5	133	87	1	20/200	5902062570567
57H058	11.0	142	94	1	20/200	5902062570581
57H062	12.0	151	101	1	20/200	5902062570628
57H064	12.5	151	101	1	20/120	5902062570642
57H066	13.0	151	101	1	20/120	5902062570666
57H014-10	2.0	49	24	10	20/600	5902062221933
57H018-10	2.5	57	30	10	20/400	5902062221957
57H020-10	3.0	61	33	10	20/400	5902062221964
57H022-10	3.2	65	36	10	20/200	5902062221971
57H023-10	3.5	70	39	10	20/200	5902062221988
57H024-10	4.0	75	43	10	20/200	5902062221995
57H026-10	4.2	75	43	10	20/200	5902062222008
57H028-10	4.5	80	47	10	20/200	5902062222015
57H030-10	4.8	86	52	10	10/100	5902062222022
57H032-10	5.0	86	52	10	10/100	5902062222039
57H034-10	5.2	86	52	10	10/100	5902062222046
57H036-10	5.5	93	57	10	10/100	5902062222053
57H038-10	6.0	93	57	10	10/100	5902062222060
57H040-10	6.5	101	63	10	5/50	5902062222077
57H042-10	7.0	109	69	10	5/50	5902062222084
57H046-5	8.0	117	75	5	10/60	5902062222107
57H048-5	8.5	117	75	5	10/60	5902062222114
57H050-5	9.0	125	81	5	10/60	5902062222121
57H054-5	10.0	133	87	5	10/60	5902062222145
57H056-5	10.5	133	87	5	10/60	5902062222152
57H058-5	11.0	142	94	5	10/40	5902062222169
57H062-5	12.0	151	101	5	10/40	5902062222183
57H066-5	13.0	151	101	5	10/40	5902062222206



Ref.	Ø [mm]	☐	☒	EAN
57H086	4, 5, 6, 8, 10	5	25/100	5902062025364
57H088	1.5, 2, 2.5, 3, 3.2, 3.5, 4, 4.2, 4.8, 5, 5.5, 6, 6.5	13	50/100	5902062570888
57H089	1, 1.5, 2, 2.5, 3, 3.5, 4, 4.5, 5, 5.5, 6, 6.5, 7, 7.5, 8, 8.5, 9, 9.5, 10	19	10/40	5902062570895
57H090	1, 1.5, 2, 2.5, 3, 3.5, 4, 4.5, 5, 5.5, 6, 6.5, 7, 7.5, 8, 8.5, 9, 9.5, 10, 10.5, 11, 11.5, 12, 12.5, 13	25	0/10	5902062570901

Wiertło bezstopniowe

Stepless Conical Bit / Stufenloser Bohrer / Свёрло коническое / Свёрдло конічне / Fokozatmentes fúró / Burghiu nelárgitor / Kuželový vrták / Kuželový vrták / Stožčasti sveder / Konusinis grąžtas / Koniskais urbis / Koonuspuur / Конично сардло / Konusno svrdlo / Glatka burgija / Τρύπανι με κωνικό στέλεχος / Broca sin grados / Punta conica / Broca sem graus / Foret non étagé / Traploze boor



Ref.	ø [mm]	⊠	EAN
57H741	4-32	10/50	5902062577412

Tarcza tnąca

Cutting disc / Schneidescheibe / Диск пильный / Диск різальний / Vágókorong / Disc tăietor / Pilový kotouč / Pilový kotouč / Rezinna plošča / Plovimo disks / Žaga disks / Lõikeketas / Режущий диск / Rezna ploča / Ploče za sečenje / Δίσκος κοπής / Disco de corte / Disco da taglio per metallo / Disco cortante / Disque de coupage / Snijlschijven



Ref.	ø1 [mm]	ø2 [mm]	W [mm]	Info	Info	⊠	⊠	EAN
55H570	115	22	1.0	41 A60-T-BF	INOX (Fe+S+Cl<0,1%)	10	7/28	5902062024374
55H572	125	22	1.0	41 A60-T-BF	INOX (Fe+S+Cl<0,1%)	10	7/28	5902062024381



Ref.	ø1 [mm]	ø2 [mm]	W [mm]	Info	⊠	⊠	EAN
55H574	115	22	1.0	41 A60-T-BF	10	7/28	5902062024398
55H576	125	22	1.0	41 A60-T-BF	10	7/28	5902062024404



Ref.	ø1 [mm]	ø2 [mm]	W [mm]	Info	⊠	EAN
57H700	125	22	1.6	41 A60-T-BF	0/25	5902062577009
57H705	115	22	1.0	41 A60-T-BF	0/25	5902062577054
57H719	230	22	1.9	41 A46-S-BF	25/50	5902062577191

Wiertło stopniowe

Stepped Conical Bit / Stufenbohrer / Свёрло ступенчатое / Свёрдло ступеневе / Lépcsős fúrószár / Burghiu lărgitor conic / Stupňovitý vrták / Stupňovitý vrták / Stopenjski sveder / Pakopinis grąžtas / Pakáryveida urbis / Astmeline puur / Многостъпално сардло / Stepenasto svrdlo / Konusna - stepenasta burgija / Τρύπανο διάνοιξης οπών με διαβάθμιση / Broca con grados / Punta conica / Broca de graus / Foret étagé / Traploze boor



Ref.	ø [mm]	⊠	EAN
57H739	4-22	50/100	5902062577399
57H740	4-32	10/50	5902062577405

Otwornica

Compass saw / Lochsäge / Ножовка / Фреза / Lyukfűrész / Ferăstrău pentru găuri / Děrovka / Dierovacia pila / Luknjariča / Vienarankis pjūklas / Rokzāģis / Augusaag / Тесен тרון / Nareznica / Ručna testera za pravljenje otvora / Πριόνι / Sierra de corona / Segga a tazza a doppio metallo / Serra para recorte / Scie à guichet / Gatensknipper



Ref.	Ø [mm]	H [mm]	⊠	EAN
57H900	16	38	8/96	5902062579003
57H902	19	38	8/96	5902062579027
57H904	20	38	8/96	5902062579041
57H901	21	38	6/72	5902062579010
57H906	22	38	8/96	5902062579065
57H908	25	38	6/72	5902062579089
57H903	27	38	8/96	5902062579034
57H910	29	38	6/72	5902062579102
57H912	32	38	8/96	5902062579126
57H914	35	38	6/24	5902062579140
57H916	38	38	6/72	5902062579164
57H918	40	38	6/24	5902062579188
57H905	44	38	6/72	5902062579058
57H920	46	38	6/24	5902062579201
57H922	51	38	6/72	5902062579225
57H907	54	38	6/24	5902062579072
57H924	57	38	6/72	5902062579249
57H909	60	38	6/24	5902062579096
57H926	64	38	6/72	5902062579263
57H928	67	38	6/24	5902062579287
57H911	70	38	6/72	5902062579119
57H930	73	38	6/72	5902062579300
57H932	83	38	6/72	5902062579324
57H913	86	38	6/24	5902062579133
57H915	92	38	6/24	5902062579157
57H934	95	38	6/24	5902062579348
57H936	105	38	6/24	5902062579362
57H917	114	38	6/24	5902062579171
57H919	140	38	6/24	5902062579195

Adapter do otwornicy

Adapter for hollow annular drill heads / Adapter für Lochsäge / Переходник для коронок / Адаптер перехідний до фрез / Adapter lyukfűrészhez / Adaptor pentru capete gaurire cu coroana / Adaptér pro děrovku / Adaptér do dierovacích pil / Adapter za luknjariče / Jungtis gręžimo karūnai / Adapteris kroņurbim / Adapter kroonpuuridele / Адаптер за сардла / Adapter za nareznice / Adapter za ručne testere / Αντάπτορας για ποτρωτήρινα / Adaptador para sierras de corona / Adattatore per sega a tazza / Adaptador do Serras para recorte / Adaptatore de scie a guichet / Adapter voor gatenknippers

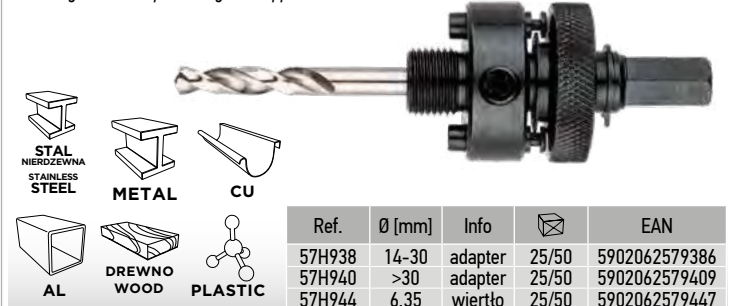

Ref.	Ø [mm]	Info	⊠	EAN
57H938	14-30	adapter	25/50	5902062579386
57H940	>30	adapter	25/50	5902062579409
57H944	6,35	wiertło	25/50	5902062579447

Wiertła-pily

Saw drills / Bohrer - Säge / Свёрла-пилы / Сверла-фрезы / Marófúró készlet / Burghie - ferästräu / Vrtáky / Pily / Frézovací vrták / Svedri-žage / Gražtai - pjūklai / Urbji-zāģi / Puurid-saed / Свёрла-триони / Svrdla pile / Burgije-testere / Прикωатά τρυπάνια / Brocas sierras / Set punta seghettata / Forêts-scies / Boorzagen

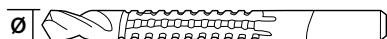

Ref.	ø [mm]	⊠	EAN
57H250	5, 6, 8	12/60	5902062572509

Fazownik

Beveller / Kegelsenker / Фаска / Фаска / Kúpos élletőró / Frezä de şanfrenare / Děrovka / Vyhľbovacia fréza / Robilnik / Freza grioveliams / Fāzes uzgalis / Servaja / Υπερ φασκη / Glodalo za skošenje / Uredaj za zakošenje / Φρεζοτρίανο / Biselador / Smussatore / Chanfrador / Outil de fraisage / Afschuinapparaat

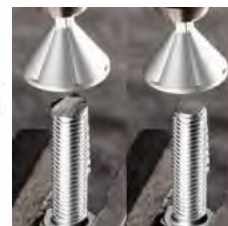

4-20 mm

Ref.	⊠	EAN
56H246	10/100	5902062075499

Frez z węglika spiekanego

Carbide rotary burr / Hartmetall-Drehgrat / Твердосплавная фреза / Твердосплавная фреза / Keresztfogazás / Freza din carbura de tungsten / Tvrdokovová rotační fréza / Fréza z tvrdokovu / Reznik iz volframovega karbida / Volframo karbido freza / Volframo karbida frēze / Frees / Фреза / Frezer / Glodalo / Фрѐза / Broca fresadora / Fresa / Fresa / Fraise / Frees



METAL

DOUBLE CUT TOOTH

type A (cylindrical)

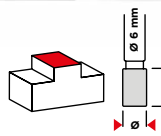

Ref.	ø [mm]	L [mm]	⊠	EAN
55H350	6	16	10/100	5902062508942
55H351	8	20	10/100	5902062508959
55H352	10	25	10/100	5902062508966
55H353	12	25	10/100	5902062508973
55H354	14	25	10/100	5902062508980
55H355	16	25	10/100	5902062508997



METAL

DOUBLE CUT TOOTH

type B (cylindrical with blades on top)

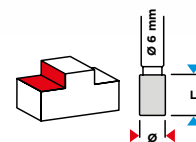

Ref.	ø [mm]	L [mm]	⊠	EAN
55H356	8	20	10/100	5902062509000
55H357	10	25	10/100	5902062509017
55H358	12	25	10/100	5902062509024
55H359	16	25	10/100	5902062509031



METAL

DOUBLE CUT TOOTH

type C (cylindrical rounded)

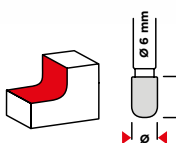

Ref.	ø [mm]	L [mm]	⊠	EAN
55H360	10	20	10/100	5902062509048
55H361	12	25	10/100	5902062509055



METAL

DOUBLE CUT TOOTH

type D (spherical)

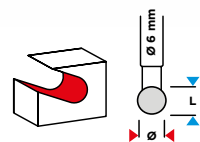

Ref.	ø [mm]	L [mm]	⊠	EAN
55H362	10	12	10/100	5902062509062



METAL

DOUBLE CUT TOOTH

type E (oval)

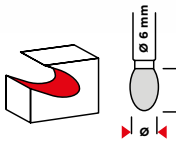

Ref.	ø [mm]	L [mm]	⊠	EAN
55H363	6	10	10/100	5902062509079
55H364	8	13	10/100	5902062509086
55H365	10	16	10/100	5902062509093
55H366	12	20	10/100	5902062509109
55H367	14	22	10/100	5902062509116
55H368	16	25	10/100	5902062509123



METAL

DOUBLE CUT TOOTH

type F (tree shape ball nose)

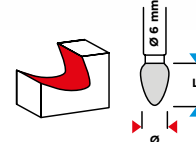

Ref.	ø [mm]	L [mm]	⊠	EAN
55H369	6	18	10/100	5902062509130
55H370	8	18	10/100	5902062509147
55H371	10	20	10/100	5902062509154
55H372	12	25	10/100	5902062509161
55H373	14	25	10/100	5902062509178
55H374	16	25	10/100	5902062509185

Frez z węgla spiekanego

Carbide rotary burr / Hartmetall-Drehgrat / Твердосплавная фреза / Твердосплавная фреза / Keresztfogazás / Freza din carbura de tungsten / Tvrđokovová rotační fréza / Fréza z tvrdokovu / Rezalnik iz volframovega karbida / Volframo karbido fresa / Volframa karbida fréze / Frees / Фреза / Frezer / Glodalo / Фрѐза / Broca fresadora / Fresa / Fresa / Fraise / Frees



METAL

DOUBLE CUT
TOOTH
type G
(tree shape point)

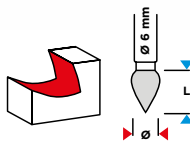

Ref.	ø [mm]	L [mm]	⊠	EAN
55H375	12	25	10/100	5902062509192

Tarcza szlifierska z rzepem

Rubber disc / Schleifscheibe mit Klettverschluss / Круг шлифовальный с липучкой / Круг шлифовальный на липучици / Rugalmas csiszoló táányér / Disc de cauciuc / Leštící kotouč se suchým zipem / Gumový disk stopkový pevný / Brusilna plošča z velkro papirjem / Guminis šlifavimo diskas / Gumijas pamatne šlipdiskam / Kummiketas / Диск зумен / Disk gumeni za bušilicu / Gumeni disk / Διακος λειανσης / Disco elastico con velcro / Disco di gomma / Disco p. esmerilhar / Meule abrasive à adhésif Velcro / Slijpschijf met velcroband

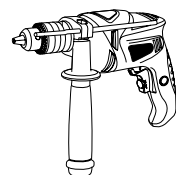
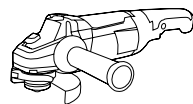

VELCRO M14

Ref.	Ø [mm]	⊠	EAN
55H928	125	0/50	5902062502803
55H929	150	0/50	5902062502810

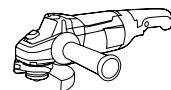

M14



VELCRO

Ref.	Ø [mm]	⊠	EAN
55H825	125	0/50	5902062502773
55H826	150	0/50	5902062502780
55H827	125	0/50	5902062502797

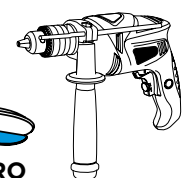

VELCRO

Ref.	Ø [mm]	⊠	EAN
55H823	125	0/50	5902062502759

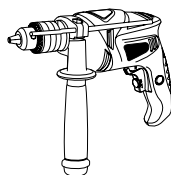

FLEXIBLE
SHAFT



VELCRO

Ref.	Ø [mm]	⊠	EAN
55H824	125	0/50	5902062502766

Włóknina ścierna

Abrasive cloth / Schleifstoff / Наждачное волокно / Волокно абразивное / Csiszolófilc / Tesáturá abrazívá / Brusné rouno / Brúsna vláknina / Brusno vlakno / Šlifavimo medžiaga / Šlipēšanas audekls / Lihvkiud / Абразивна тънана / Brusna tkanina / Abrazivna tkanina / Υφασμα λειανσης / Tela de lijar / Tessuto abrasivo / Tecido abrasivo / Textile abrasif / Papieren zak



METAL

Ref.	Ø [mm]	⊠	EAN
55H992	125 x 22.2	5/100	5902062503473

Adapter

Adaptor / Adapter / Адаптер / Перехідник / Közdarab, adapter / Adaptor / Adaptér / Adaptér / Adapter / Jungtis / Adapteris / Adapter / Адаптер / Adapter / Adapter / Ανάτορας / Adaptador / Adattatore / Adaptador / Adaptateur / Adapter

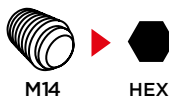

M14

HEX

Ref.	⊠	EAN
55H320	10/100	5902062509437

Krażki ściernie

Abrasive discs / Schleifscheibe / Шлифовальные круги / Круги шлифовальные / Csiszolókorongok / Discuri abrazive / Brusné kroužky / Brúsné kotúče / Brusne plošče / Šlijavimo diskeliai / Slīpēšanas aplī / Lihvrångad / Абразивни дискове / Brusni kolutiči / Diskovi za brušenje / Δίσκοι λείανσης / Hoja de lija circular / Dischi abrasivi / Discos abrasivos / Roulette abrasive / Schuurwielen

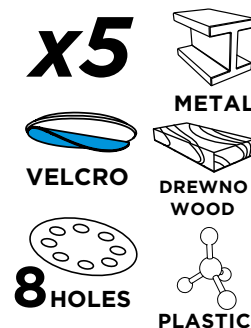
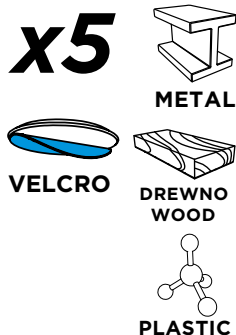

Ref.	Info	Ø [mm]			EAN
55H933	K40	125	5	0/200	5902062502414
55H934	K60	125	5	0/200	5902062502421
55H935	K80	125	5	0/200	5902062502438
55H936	K100	125	5	0/200	5902062502469
55H937	K120	125	5	0/200	5902062502476
55H938	K240	125	5	0/200	5902062502483

Ref.	Info	Ø [mm]			EAN
55H939	K40	125	5	0/200	5902062502490
55H940	K60	125	5	0/200	5902062502506
55H941	K80	125	5	0/200	5902062502513
55H942	K100	125	5	0/200	5902062502520
55H943	K120	125	5	0/200	5902062502537
55H944	K240	125	5	0/200	5902062502544

Ściernica listkowa

Flap wheel / Blatt-Schleifscheibe / Листовой шлифовальный круг / Круг шлифовальный листковой / Lamellás csiszoló / Disc de rectificat / Brusný kotouč listkový / Brúsný lamelový tanier / Brus z lističi / Šlijavimo lapelīai / Lokšņu slīpēšanas riņķis / Lamell-lihvketas / Ламелен диск / Lepezasta brusna ploča / Kolut za brušenje / Τροχός λείανσης με πτερύγια / Abanico lijador / Spazzola lamellare / Disco abrasivo de folhas / Meule abrasive à lamelles / Schuurblad



Ref.	Info	Ø [mm]		EAN
57H835	K40	115 x 22.2	20/100	5902062503428
57H836	K60	115 x 22.2	20/100	5902062503435
57H837	K80	115 x 22.2	20/100	5902062503442
57H838	K100	115 x 22.2	20/100	5902062503459
57H839	K120	115 x 22.2	20/100	5902062503466
57H840	K36	125 x 22.2	20/100	5902062997012
57H841	K40	125 x 22.2	20/100	5902062997029
57H842	K60	125 x 22.2	20/100	5902062997036
57H843	K80	125 x 22.2	20/100	5902062997043
57H844	K100	125 x 22.2	0/100	5902062997050
57H845	K120	125 x 22.2	20/100	5902062997067

Ref.	Info	Ø [mm]		EAN
55H980	K36	115 x 22.2	20/100	5902062503305
55H981	K40	115 x 22.2	20/100	5902062503312
55H982	K60	115 x 22.2	20/100	5902062503329
55H983	K80	115 x 22.2	20/100	5902062503336
55H984	K100	115 x 22.2	20/100	5902062503343
55H985	K120	115 x 22.2	20/100	5902062503350
55H986	K36	125 x 22.2	20/100	5902062503367
55H987	K40	125 x 22.2	20/100	5902062503374
55H988	K60	125 x 22.2	20/100	5902062503381
55H989	K80	125 x 22.2	20/100	5902062503398
55H990	K100	125 x 22.2	20/100	5902062503404
55H991	K120	125 x 22.2	20/100	5902062503411

Krażki ściernie fibra

Abrasive fibre discs / Fiberschleifscheiben / Шлифовальные фибровые круги / Круги абразивни фибра / Csiszoló korongok fibra / Discuri abrazive fibre / Brusné kotouče fibr / Vlákňité brusné kotúče / Brusni diskovi fibra / Abrazyviniai šlijavimo diskai / Slīpēšanas šķiedradiski / Kiud-abrasivkettad / Абразивни фибър дискове / Fiber brusni diskovi / Brusni fiber disk / Ινώδεις δίσκοι λείανσης / Discos de fibra / Dischi abrasivi in fibra / Discos abrasivos fibra / Disques abrasifs à fibres / Schuurschijven fiber

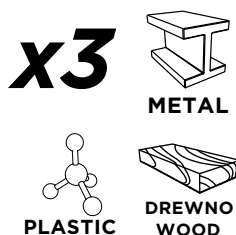

Ref.	Info	Ø [mm]			EAN
55H855	K40	125	3	0/100	5902062810809
55H856	K60	125	3	0/100	5902062810816
55H857	K80	125	3	0/100	5902062810823
55H858	K100	125	3	0/100	5902062810830
55H859	K120	125	3	0/100	5902062810847

Tarcza do fibry

Backing pad for fibre discs / Schleifteller für Fiberscheiben / Диск для фибры / Диск до фибры / Fibertárcsa / Disc pentru fibră / Kotouč na fibr / Kotuč na vlákno / Podložna plošča / Pluošta diskai / Disks fibrai / Fibriketas / Фибер диск / Ploča za fibru / Fiber disk / Πέλμα δίσκων από ινώδες υλικό / Disco para fibra / Disco di fibra / Disco para fibra / Disque fibre / Schijf voor fibra



Ref.	Ø [mm]		EAN
57H860	125	1/100	5902062502742

Ściernica trzpieniowa, listkowa

Sanding label cylinder / Blattschleifstift / Круж шлифовальный лепестковый / Круж абразивный лепестковый / Csapos csiszolókorong / Cilindru de șlefuit / Brusný kotouč listkový s trnem / Brusný kotúč listkový so stopkou / Lamelni brus / Šlifavnio padas / Šlīplapu disks / Lihvisilinder / Шкурка вентуро / Lamelni brus sa osovinom / Lamelni brus sa osovinom / Λεπαντικός κύλινδρος / Abanico lijador / Mola a mandrino, fogli / Roda de esmeril / Meule abrasive à tige, à lamelles / Blad zandsteen



METAL



DREWNO
WOOD

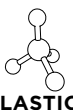

PLASTIC

Ref.	Info	W [mm]	☒	EAN
55H754	K40	40x20	1/150	5902062503213
55H755	K60	40x20	1/150	5902062503220
55H756	K80	40x20	1/150	5902062503237
55H757	K40	60x30	1/100	5902062503244
55H758	K60	60x30	1/100	5902062503251
55H759	K80	60x30	1/100	5902062503268
55H760	K40	80x30	1/100	5902062503275
55H761	K60	80x30	1/60	5902062503282
55H762	K80	80x30	1/60	5902062503299

Szczotka druciana

Wire brush / Drahtbürste / Щетка проволочная / Щітка по металу / Fazékkéfe sodrott / Perie metal / Drátěný kartáč / Keľa drôtená univerzálna / Žična krtača / Vielinis šepetys / Dräsu birste / Traathari / Четка мелена / Četka sa PVC drškom / Cetka / Συρμάτινη βούρτσα / Cepillo de alambre / Spazzola a tazza / Escova de arame / Brosse métallique / Draadborstel

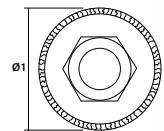

INOX
Ø0.5mm



M14



STAL
NIERDZEWNA
STAINLESS
STEEL

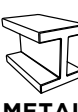

METAL

Ref.	Ø1 [mm]	n _r max [min ⁻¹]	☒	EAN
57H581	65	12 500	6/60	5902062575814
57H582	80	12 500	6/60	5902062575821
57H583	100	8 500	6/30	5902062575838

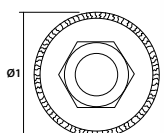

INOX
Ø0.5mm



M14



STAL
NIERDZEWNA
STAINLESS
STEEL

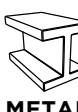

METAL

Ref.	Ø1 [mm]	n _r max [min ⁻¹]	☒	EAN
57H585	65	12 500	6/60	5902062575852
57H587	100	8 500	6/18	5902062575876

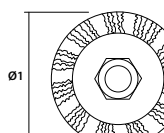

INOX
Ø0.5mm



M14



STAL
NIERDZEWNA
STAINLESS
STEEL

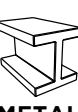

METAL

Ref.	Ø1 [mm]	n _r max [min ⁻¹]	☒	EAN
57H589	100	12 500	6/60	5902062575890
57H591	115	12 500	0/60	5902062575913

Szczotka druciana

Wire brush / Drahtbürste / Щетка проволочная / Щітка по металу / Fazékkéfe sodrott / Perie metal / Drátěný kartáč / Keľa drôtená univerzálna / Žična krtača / Vielinis šepetys / Dräsu birste / Traathari / Четка мелена / Četka sa PVC drškom / Cetka / Συρμάτινη βούρτσα / Cepillo de alambre / Spazzola a tazza / Escova de arame / Brosse métallique / Draadborstel

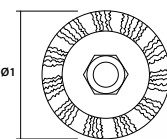

INOX
Ø0.5mm



M14



STAL
NIERDZEWNA
STAINLESS
STEEL

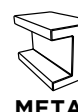

METAL



Ref.	Ø1 [mm]	n _r max [min ⁻¹]	☒	EAN
57H596	115	12 500	6/60	5902062575968
57H598	125	12 500	6/60	5902062575982

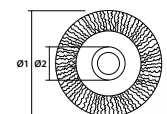

INOX



STAL
NIERDZEWNA
STAINLESS
STEEL

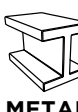

METAL



Ref.	Ø1 [mm]	Ø2 [mm]	n _r max [min ⁻¹]	☒	EAN	
57H592	125	20	8 500	16, 12 mm	6/60	5902062575920

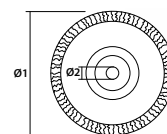

INOX



Ø6.25mm



STAL
NIERDZEWNA
STAINLESS
STEEL

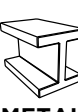

METAL



Ref.	Ø1 [mm]	Ø2 [mm]	n _r max [min ⁻¹]	☒	EAN
57H599	50	6,1	4 500	12/120	5902062575999
57H600	75	6,1	4 500	12/120	5902062576002

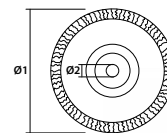

INOX



Ø6.25mm



STAL
NIERDZEWNA
STAINLESS
STEEL

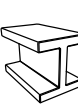

METAL



Ref.	Ø1 [mm]	Ø2 [mm]	n _r max [min ⁻¹]	☒	EAN
57H601	50	6,25	4 500	12/120	5902062576019
57H602	75	6,25	4 500	12/120	5902062576026

Papier ścierny

Sanding paper / Schleifpapier / Бумага наждачная / Папір наждачний / Csizsolópapír / Hírtie smirghel ce se încheie singură / Brúsný papír / Papier brúsný-roľka / Brúsní papír / Šlifavito papirius / Smiřšpapis / Liivaraber / Шкурка руло / Brúsní papír u roli / Brúsní papír / Λειαντικό ύφανση / Lija / Carta abrasiva / Folha de lixa / Papier abrasif / Schuurpapier



Ref.	Info	W [mm]	☒	EAN
55H896	K60	280x230	0/500	5902062888198
55H897	K80	280x230	0/500	5902062888204
55H898	K100	280x230	0/500	5902062888211
55H899	K120	280x230	0/500	5902062888228
55H900	K150	280x230	0/1000	5902062888235
55H901	K180	280x230	0/1000	5902062888242
55H902	K220	280x230	0/1000	5902062888259
55H903	K240	280x230	0/1000	5902062888266
55H904	K320	280x230	0/1000	5902062888273
55H905	K600	280x230	0/1000	5902062888280
55H906	K800	280x230	0/1000	5902062888297
55H907	K1000	280x230	0/1000	5902062888303
55H908	K1200	280x230	0/1000	5902062888310
55H909	K1500	280x230	0/1000	5902062888327
55H910	K2000	280x230	0/1000	5902062888334
55H911	K2500	280x230	0/1000	5902062888341



Ref.	Info	W [mm]	☒	EAN
55H884	K36	280x230	0/500	5902062888082
55H885	K40	280x230	0/500	5902062888099
55H886	K60	280x230	0/500	5902062888105
55H887	K80	280x230	0/500	5902062888112
55H888	K100	280x230	0/500	5902062888129
55H889	K120	280x230	0/1000	5902062888136
55H890	K150	280x230	0/1000	5902062888143
55H891	K180	280x230	0/1000	5902062888150
55H892	K200	280x230	0/1000	5902062888167
55H893	K220	280x230	0/1000	5902062888174
55H894	K240	280x230	0/1000	5902062888181

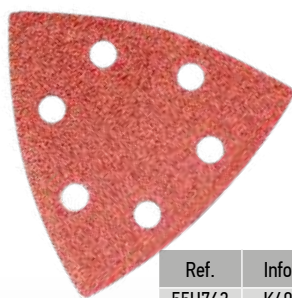

x5

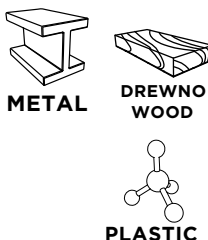

Ref.	Info	W [mm]	☒	☒	EAN
55H763	K40	93x93	5	0/200	5902062502827
55H764	K60	93x93	5	0/200	5902062502834
55H765	K80	93x93	5	0/200	5902062502841
55H766	K100	93x93	5	0/200	5902062502858
55H767	K120	93x93	5	0/200	5902062502865
55H768	K240	93x93	5	0/200	5902062502872

Plótna ścierna

Abrasive cloths / Schleifleinen / Шлифовальные полотна / Полотна наждакові / Csizsolóvászonok / Pánze abrasive / Brúsná plátna / Brúsné plátna / Brusna platna / Šlifavito papirieria / Šlipēšanas audeklis / Lihvriie / Абразивни платна / Brusna platna / Абразивна платна / Χαριά λειανσης / Lijas de tela / Tessuti abrasivi / Tecidos abrasivos / Toiles abrasives / Schuurtextielen



Ref.	Info	W [mm]	☒	EAN
55H873	K36	280x230	0/250	5902062810984
55H874	K40	280x230	0/250	5902062810991
55H875	K60	280x230	0/250	5902062888006
55H876	K80	280x230	0/500	5902062888013
55H877	K100	280x230	0/500	5902062888020
55H878	K120	280x230	0/500	5902062888037
55H879	K150	280x230	0/500	5902062888044
55H880	K180	280x230	0/500	5902062888051
55H881	K220	280x230	0/500	5902062888068
55H882	K240	280x230	0/500	5902062888075

Gąbka ścierna

Abrasive sponge / Scheuerschwamm / Абразивная губка / Губка наждачна / Csizsolószivacs / Burete abraziv / Brúsná houba / Brúsná špongia / Brusna gobica / Abrazivné kempine / Šlipēšanas sūklis / Lihvimiskāsn / Абразивна гъба / Brusna spužva / Abrazivni sunder / Λειαντικό αφουγγάρι / Esponja abrasiva / Spugna abrasiva / Esponja abrasiva / Éponge abrasive / Schurende spons /

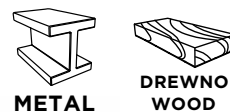

Ref.	Info	W [mm]	☒	EAN
55H912	K60	120 x 95 x 10	0/250	5902062888358
55H913	K100	120 x 95 x 10	0/250	5902062888365
55H914	K180	120 x 95 x 10	0/250	5902062888372



Ref.	Info	W [mm]	☒	EAN
55H915	K60	70 x 25 x 100	0/250	5902062888389
55H916	K80	70 x 25 x 100	0/250	5902062888396
55H917	K100	70 x 25 x 100	0/250	5902062888402
55H918	K120	70 x 25 x 100	0/250	5902062888419
55H919	K150	70 x 25 x 100	0/250	5902062888426
55H920	K180	70 x 25 x 100	0/250	5902062888433
55H921	K240	70 x 25 x 100	0/250	5902062888440

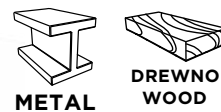

Ref.	Info	W [mm]	☒	EAN
55H925	K80	98 x 25 x 68	0/200	5902062888488
55H926	K120	98 x 25 x 68	0/200	5902062888495
55H927	K180	98 x 25 x 68	0/200	5902062888501

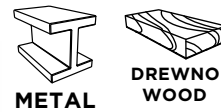

Ref.	Info	W [mm]	☒	EAN
55H922	K80	125 x 25 x 90	0/200	5902062888457
55H923	K120	125 x 25 x 90	0/200	5902062888464
55H924	K180	125 x 25 x 90	0/200	5902062888471

Brzeszczoty bagietowe

Sabre saw blade / Bajonett-Sägenblatt / Полотно / Полотно пильні з точним зубом / Orrfűrészlap / Panze baioneta / Mečové pilové listy / Mečové pilové listy / Bajonetni žagni listi / Bimetaliniai pjūkliukai / Asmens zobenzāģim / Töök-saelehed / Сменяемые лентки для трона / Bajonet listovi pile / Oštrice noža / Прионόλαμες / Hojas de sable / Lama per sega a gattuccio / Láminas / Lames de scie à baionnette / Sabel mesbladen

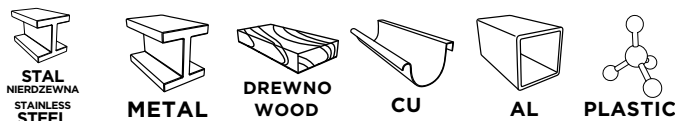

x2

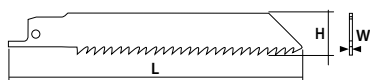

Ref.	L [mm]	H [mm]	W [mm]	TPI / mm			EAN
57H947	250	20	0.9	10 / 2.5	2	0/100	5902062579478
57H948	300	20	0.9	14 / 1.8	2	0/1	5902062579485
57H950	150	20	0.9	10-14 / 2.5-1.8	2	0/150	5902062579508
57H951	150	20	0.9	14 / 1.8	2	0/1	5902062579515
57H952	225	20	0.9	14 / 1.8	2	0/150	5902062579522
57H953	225	20	0.9	18 / 1.4	2	0/100	5902062579539
57H954	225	20	0.9	6 / 4.0	2	0/1	5902062579546

Brzeszczot do pilarki szablastej

Blade for reciprocating saw / Sägeblatt für Säbelsäge / Пильное полотно для сабельной пилы / Полотно до сабельной пилы / Orrfűrész fűrészlap / Pánzá fjerástráú sabie / Pilový list pro šavlovou pilu / Cepel' šablonej píly / List za sabljasto žago / Pjūkliukas tiesiniam pjūkliui / Zobenzāģa asmenis / Saabelsae tera / Ножовка за саблен трон / List za sabljastu pilu / Sečivo za kružnu testeru / Прионόλαμα για σπαθόσαγα / Hoja de sierra para sierra de sable / Lama per sega a gattuccio / Lámina para serra de sabre / Lame de scie sabre / Mes voor sabelzaag

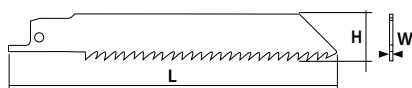

x2 BIM



Ref.	TPI	L [mm]	H [mm]	W [mm]		EAN
56H040	18	150	19	0.8	25/100	5902062506627

x3 BIM

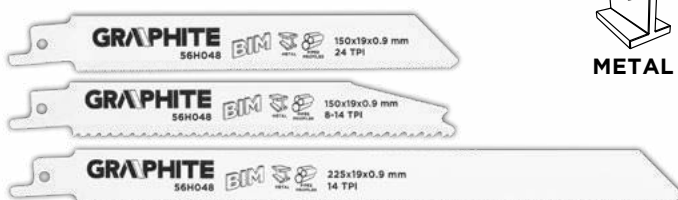

Ref.	TPI	L [mm]	H [mm]	W [mm]		EAN
56H048	24/8-14/14	150/150/225	19	0.9	5/20	5902062506702

Statyw do szlifierek kątowych

Angle grinder support / Gestell für Winkelschleifer / Держатель для угловых шлифмашин / Штатив до шлифмашини кутювоу (болеарок) / Állvány sarokcsiszolóhoz / Stativ pentru polizor unghiular / Stojan na uhlové brusky / Stojan na uhlové brusky / Stojalo za kotni brusilnik / Stovas kampiniam šlifjuokliui / Leřka šlirmařinas stativs / Statiiv nurklrhvjale / Статив за ъглошпауф / Stativ za kutne brusilice / Stativ za ugaone brusilice / Ορθοστάτης για γωνιακούς λειαντήρες / Soporte para amoladora angular / Supporto per smerigliatrice angolare / Suporte para esmerilhadora de canto / Bâti pour meuleuses d'angle / Steun voor versteekschuurmachines

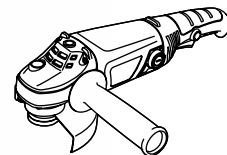
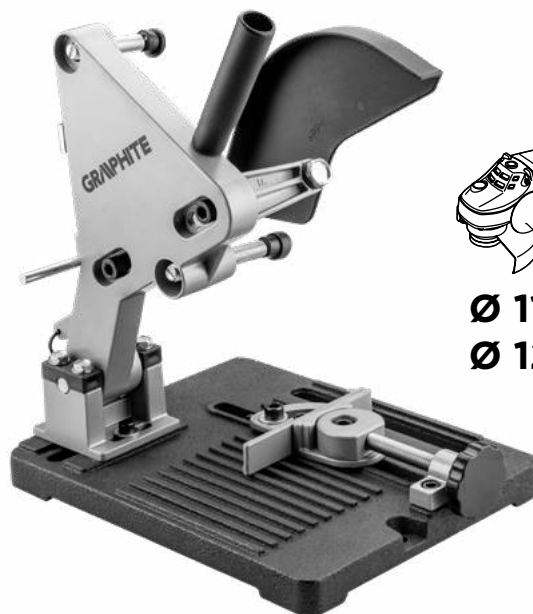

Ø 115 mm
Ø 125 mm

Ref		EAN
56H650	0/4	5902062045652

Statyw do wiertarki

Drill stand / Gestell für Bohrmaschine / Держатель для дрели / Штатив до дрели / Fúróállvány / Stativ pentru masina de gaurit / Stojan na vrtačku / Stojan na vrtačku / Stojalo za vrtalnik / Stovas grežtuvui / Urbjmařinas stativs / Statiiv trellile / Статив за пробивна машина / Stativ za bušilicu / Stativ za bušilicu / Ορθοστάτης βρανάνου / Soporte para taladradoras / Supporto per trapano / Suporte de berbequim / Bâti pour perceuse / Steun voor boormachine

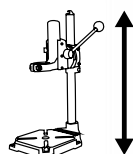

400mm

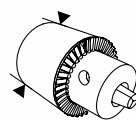

Ø 43 mm

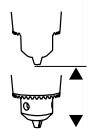

max 60 mm

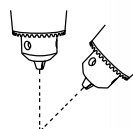

max 90°



Ref		EAN
56H655	0/6	5902062045676

Brzeczot

Bow saw blade / Sägeblatt / Полотно ножовочное / Полотно до ножівки лучкової / Fűrészlap multifunkciós géphez / Lama ferăstrău cu arc / List pily / Plátok náhradný / Rezilni list / Geležite / Asmenis lokžajim / Vibusee leht / Лист за триян бычния / List Pile / List testere / Λεπίδα για τοξοπίδιο / Hoja de sierra de arco / Lama per metallo HSS / Lámina / Lama de scie



HSS



METAL

Ref.	W [mm]	☒	EAN
56H006	34	5/150	5902062690067



BI-METAL
Co 8%



METAL

Ref.	W [mm]	☒	EAN
56H055	34	10/100	5902062019714
56H056	20	10/100	5902062019721
56H057	10	10/100	5902062019738



HSS



METAL

Ref.	W [mm]	☒	EAN
56H061	87	10/100	5902062019776



METAL

Ref.	☒	☒	EAN
56H072	3	10/60	5902062022134

Skrobak sztywny

Stiff scraper / Schaber / steif / Скребок жесткий / Скребок жорсткий / Fa kaparó multigéphez / Răzuitor rigid / Tuhý škrabák / Tvrdá špachtla / Togo strigalo / Grandiklis tiesus / Stingsr kasiklis / Jäik kaabits / Твёрд шабёр / Kruta strugalica / Grubi šabler / Σκληρή ξίστρα / Rasqueta no elástica / Raschietto rigido per legno / Raspador duro / Racle rigide



HSS

Ref.	W [mm]	☒	EAN
56H010	50	5/150	5902062690104

Papiery szlifierskie

Sanding paper / Schleifpapier / Бумага наждачная / Папір наждачний / Csiszolópapír multigéphez / Hírtie smirghe ce se încheie singură / Brusný papír / Papier brúsný-roľka / Brusni papir / Šlifavimo papierius / Smilšpapīrs / Liivaraber / Шкурка руло / Brusni papir u roli / Brusni papir / Λειαντικό ύφανση / Lija / Carta abrasiva / Folha de lixa / Papier abrasif



x5

Ref.	W [mm]	Info	☒	EAN
56H014	83 x 83 x 83	K60 x 2; K80 x 2; K100 x 1	5/100	5902062690142

Stopa szlifierska

Sanding pad / Schleifteller / Шлифовальная подошва / Шліфувальна поверхня трикутна / Csiszolófej multigéphez / Talpă de șlefuit / Brusná deska / Pracovná pätká brúsky / Brusna plošča / Šlifavimo padas / Šlīpēšanas pēda / Lihvtald / Шлифовочен пплат / Brusni tanjur / Postolje za brušenje / Πλάκα λείανσης / Placa lijadora / Piastra levigatrice / Complemento da lixa / Plateau de ponçage



Ref.	W [mm]	☒	EAN
56H012	83 x 83 x 83	5/100	5902062690128



Ref.	W [mm]	☒	EAN
56H013	83 x 83 x 83 mm	5/100	5902062007704

Adapter do urządzenia wielofunkcyjnego

Multi-purpose adapter / Adapter für Multifunktionsgerät / Переходник для многофункционального устройства / Адаптер для багатифункционального пристрою / Adapter univerzális berendezéshez / Adaptor pentru dispozitiv multifunctional / Adaptér pro multifunkční zařízení / Adaptér pre multifunkčné zariadenie / Priključek za večnamensko napravo / Daugiafunkcio įrenginio adapteris / Adapteris daudzfunkcionālai iekārtai / Multifunktsionaalse seadme adapter / Адаптер за мултифункционално устройство / Adapter za višenamjenski uređaj / Adapter za višefunkcionalne uređaje / Προσαρμογέας πολυεργαλείων / Adaptador para el dispositivo multifunción / Adattatore per il dispositivo multifunzionale / Adaptador para o dispositivo multifunção / Adaptateur pour le dispositif multifonction / Adapter voor multifunctioneel apparaat

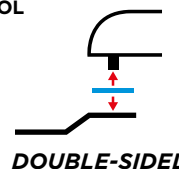

Ref.	☒	EAN
56H420	10/100	5902062071316

Filc polerski

Polishing felt / Polierfilz / Фетр полировочный / Фильц полирувальний / Polirkorong / Píslá sľeuvre / Leštící plst / Filcový disk / Filc za poliranje / Veltinis poliravimui / Filcis pulēšanai / Poleerimisvilt / Диск за полиране / Filc za poliranje / Filc za poliranje / Τάχα γυαλίσματος / Fieltro para pulir / Feltro per lucidatura / Feltro para poli / Feutre de polissage / Polijstvilt

NEO
TOOLS



Ref.	Info	☒	EAN
08-960	Ø 75 mm, 10 mm	1/100	5907558454505
08-961	Ø 125 mm, 10 mm	1/100	5907558454512
08-962	Ø 125 mm, 20 mm	1/100	5907558454529

Tarcza elastyczna

Backing pad / Flexible Scheibe / Эластичный диск / Диск еластичний / Elasztikus tárcsa / Disc elastic / Elastický kotouč / Elastický kotúč / Elastická plošča / Elastinis diskas / Elastigais disks / Elastne kets / Эластичен диск / Elastična ploča / Elastična ploča / Ελαστικός δίσκος / Disco elástico / Disco elastico / Disco elástico / Disque flexible / Flexibele schijf /

NEO
TOOLS



Ref.	Info	☒	EAN
08-977	Ø 75 mm, max 20150 min⁻¹	1/100	5907558454673
08-968	Ø 125 mm, max 6000 min⁻¹	1/100	5907558454581

Pad polerski

Foam pad / Polierkissen / Полировальная подушка / Полировальная подушка / Polirózó betét / Tampon de lustruit / Leštící podložka / Leštiaca podložka / Blazinica za poliranje / Poliravimo padas / Pulēšanas spilventiņš / Poleerimisradi / Полираща гъба / Spružva za poliranje / Подлога за полирање / Σπόγγος σιλβωσης / Almohadilla de pulido / Tampone per lucidatura / Almofada de polimento / Tampon de polissage / Polijstpad

NEO
TOOLS



Best used
with NEO
backing pad
08-968

Ref.	Info	☒	EAN
08-963	cutting	1/100	5907558454536
08-964	very hard	1/100	5907558454543
08-965	hard	1/100	5907558454550
08-966	medium	1/100	5907558454567
08-967	soft	1/100	5907558454574

NEO
TOOLS



Ref.	Info	☒	EAN
08-978	cutting	1/100	5907558495157
08-979	very hard	1/100	5907558495164
08-980	hard	1/100	5907558495171
08-981	medium	1/100	5907558495188
08-982	soft	1/100	5907558495195

NEO
TOOLS



Ref.	Info	☒	EAN
08-969	cutting	1/100	5907558454598
08-970	very hard	1/100	5907558454604
08-971	hard	1/100	5907558454611
08-972	medium	1/100	5907558454628
08-973	soft	1/100	5907558454635

NEO
TOOLS



Best used
with NEO
backing pad
08-977

Ref.	Info	☒	EAN
08-974	hard	1/100	5907558454642
08-975	medium	1/100	5907558454659
08-976	soft	1/100	5907558454666

Uchwyt magnetyczny

Magnetic holder / Magnetaufnahme / Держатель магнитный / Патрон магнітний / Toldószár behajt / Suport magnetic / Magnetický držák / Magnetické skľučovadlo / Magneto vpenjalo / Magnetinis griebtuvas / Magnētiskais turētājs / Magnetpadrun / Магнітен държач / Magneta hvataljka / Magneta drška / Υποδοχή μαγνητική / Mandril de sujeción magnético / Porta inserti con giunto sferico / Suporte magnético / Manche magnétique / Magnetisch houder

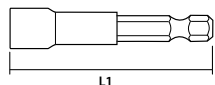

IMPACT PROOF

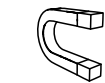

MAGNETYCZNY MAGNETIC



1/4"



Ref.	L [mm]	☒	EAN
56H554	60	50/100	5902062504777

Adapter

Adaptor / Adapter / Адаптер / Перехідник / Közdarab, adapter / Adaptor / Adaptér / Adaptér / Adapter / Jungtis / Adapteris / Adapter / Адаптер / Adapter / Adapter / Ανάτορας / Adaptador / Adattatore / Adaptador / Adaptateur / Adapter



IMPACT PROOF



1/4"



Ref.	info	☒	EAN
56H555	1/4" HEX -> 1/4" [O]	50/100	5902062504784
56H556	1/4" HEX -> 1/2" [O]	50/100	5902062504791



1/2"

1/4"

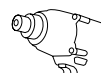

IMPACT PROOF

Ref.	L [mm]	☒	EAN
56H557	50	20/40	5902062102416

Przedłużka

Extension / Erweiterung / Расширение / Розширення / Hosszabbítás / Extensie / Prodloužení / Rozšírenie / Podaljšek / Pratešimas / Paplašinājums / Pīkendus / Удължение / Пројужение / Продужетак / Επέκταση / Extensión / Estensione / Extensão / Extension / Uitbreiding



1/4"

1/4"



MAGNETYCZNY MAGNETIC



IMPACT PROOF



Ref.	L [mm]	☒	EAN
56H558	150	10/40	5902062102423

Bity udarowe

Impact bits / Schlag-Bits / Ударные вставки / Бити ударни / Ütvecsavarozó bitek / Bit de impact / Úderové bity / Nárazové bity / Udarni biti / Smüginiai antgaliai / Triecienuzgali / Löökmehslid / Ударни битоие / Udarni bitovi / Udarni bitovi / Κρουστικές μύτες / Bits de impacto / Inserti a percussione / Pontas de percussão / Embouts à choc / Slagbits



x2



PH



IMPACT PROOF



1/4"

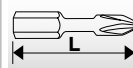

Ref.	Info	L [mm]	☒	☒	EAN
56H500	PH1	25	2	50/100	5902062504364
56H501	PH2	25	2	50/100	5902062504371
56H502	PH3	25	2	50/100	5902062504388



x2



PZ



IMPACT PROOF



1/4"

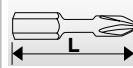

Ref.	Info	L [mm]	☒	☒	EAN
56H503	PZ1	25	2	50/100	5902062504395
56H504	PZ2	25	2	50/100	5902062504401
56H505	PZ3	25	2	50/100	5902062504418
56H506	PZ4	25	2	50/100	5902062504425



x2



HEX



IMPACT PROOF



1/4"

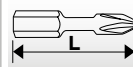

Ref.	Info	L [mm]	☒	☒	EAN
56H507	HEX4	25	2	50/100	5902062504333
56H508	HEX5	25	2	50/100	5902062504340
56H509	HEX6	25	2	50/100	5902062504357



x2



SL



IMPACT PROOF



1/4"



Ref.	Info	L [mm]	☒	☒	EAN
56H510	SL5.5	25	2	50/100	5902062504432
56H511	SL6.5	25	2	50/100	5902062504449



x2



TX



IMPACT PROOF



1/4"



Ref.	Info	L [mm]	☒	☒	EAN
56H512	TX15	25	2	50/100	5902062504456
56H513	TX20	25	2	50/100	5902062504463
56H514	TX25	25	2	50/100	5902062504470
56H515	TX27	25	2	50/100	5902062504494
56H516	TX30	25	2	50/100	5902062504500
56H517	TX40	25	2	50/100	5902062504517

Bity udarowe

Impact bits / Schlag-Bits / Ударные вставки / Бити ударні / Útvecsavarozó bitek / Bit de impact / Úderové bity / Nárazové bity / Udarni biti / Smūginiai antgaliai / Triecienuzgaļi / Löökmeislid / Ударни бумосе / Udarni bitovi / Udarni bitovi / Κρουστικές μύτες / Bits de impacto / Inserti a percussione / Pontas de percussão / Embouts à choc / Slagbits



x2
S2
PH

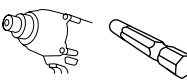
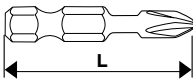

IMPACT PROOF 1/4"

Ref.	Info	L [mm]	📦	📧	EAN
56H518	PH1	50	2	50/100	5902062504524
56H519	PH2	50	2	50/100	5902062504531
56H520	PH3	50	2	50/100	5902062504548



x2
S2
PZ

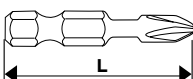

IMPACT PROOF 1/4"

Ref.	Info	L [mm]	📦	📧	EAN
56H521	PZ1	50	2	50/100	5902062504555
56H522	PZ2	50	2	50/100	5902062504562
56H523	PZ3	50	2	50/100	5902062504579



x2
S2
TX

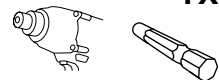
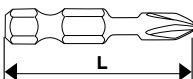

IMPACT PROOF 1/4"

Ref.	Info	L [mm]	📦	📧	EAN
56H524	TX15	50	2	50/100	5902062504586
56H525	TX20	50	2	50/100	5902062504593
56H526	TX25	50	2	50/100	5902062504623
56H527	TX27	50	2	50/100	5902062504647
56H528	TX30	50	2	50/100	5902062504661
56H529	TX40	50	2	50/100	5902062504685



x3
S2
PH

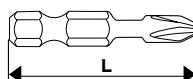

IMPACT PROOF 1/4"

Ref.	Info	L [mm]	📦	📧	EAN
56H543	PH1/PH2/PH3	50	3	50/100	5902062504722

NEO TOOLS



S2 steel
50 mm x5

Ref.	Info	L [mm]	📦	📧	EAN
09-575	PH1	50	5	12/96	5907558450484
09-576	PH2	50	5	12/96	5907558450491
09-577	PH3	50	5	12/96	5907558450507

NEO TOOLS



S2 steel
50 mm x5

Ref.	Info	L [mm]	📦	📧	EAN
09-578	PZ1	50	5	12/96	5907558450514
09-579	PZ2	50	5	12/96	5907558450521
09-580	PZ3	50	5	12/96	5907558450538

NEO TOOLS



S2 steel
50 mm x5

Ref.	Info	L [mm]	📦	📧	EAN
09-584	TX20	50	5	12/96	5907558450576
09-585	TX25	50	5	12/96	5907558450583
09-587	TX30	50	5	12/96	5907558450606
09-588	TX40	50	5	12/96	5907558450613



x3
S2
PZ

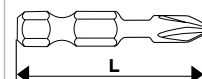

IMPACT PROOF 1/4"

Ref.	Info	L [mm]	📦	📧	EAN
56H542	PZ1/PZ2/PZ3	50	3	50/100	5902062504715

Bity udarowe

Impact bits / Schlag-Bits / Ударные вставки / Бити ударни / Ütvecsavarazó bitek / Bit de impact / Úderové bity / Nárazové bity / Udarni biti / Smūginiai antgaliai / Triecienuzgaļi / Löökmeislid / Ударни битове / Udarni bitovi / Udarni bitovi / Κρουστικές μύτες / Bits de impacto / Inserti a percussione / Pontas de percussão / Embouts à choc / Slagbits



Ref.	Info	L [mm]	📦	📦	EAN
56H540	PH1/PH2/PH3, PZ1/PZ2/PZ3	25	6	50/100	5902062504692

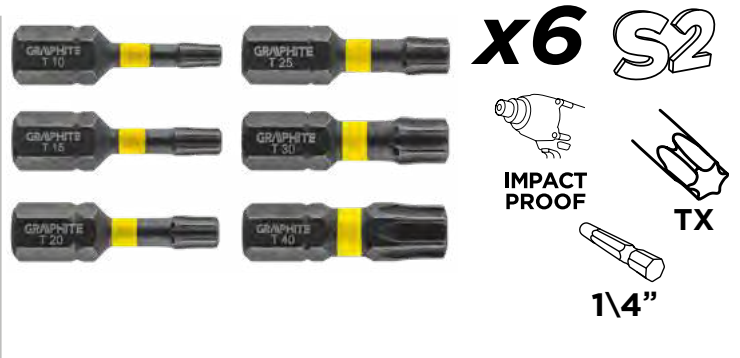

Ref.	Info	L [mm]	📦	📦	EAN
56H541	TX10/TX15/TX20, TX25/TX30/TX40	25	6	50/100	5902062504708



Ref.	Info	L [mm]	📦	📦	EAN
56H544	TX15	25	20	10/100	5902062102362
56H545	TX20	25	20	10/100	5902062102386
56H546	TX25	25	20	10/100	5902062102393
56H547	TX30	25	20	10/100	5902062102409

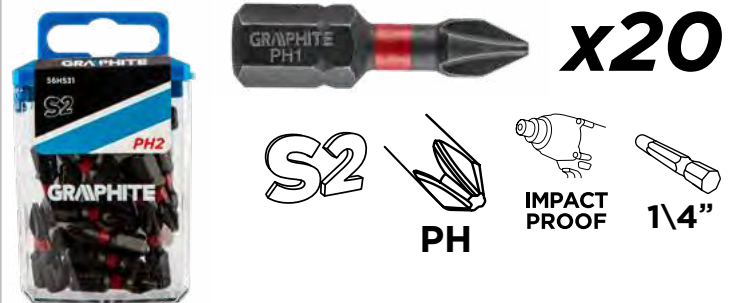

Ref.	Info	L [mm]	📦	📦	EAN
56H530	PH1	25	20	10/100	5902062504821
56H531	PH2	25	20	10/100	5902062504838
56H532	PH3	25	20	10/100	5902062504845

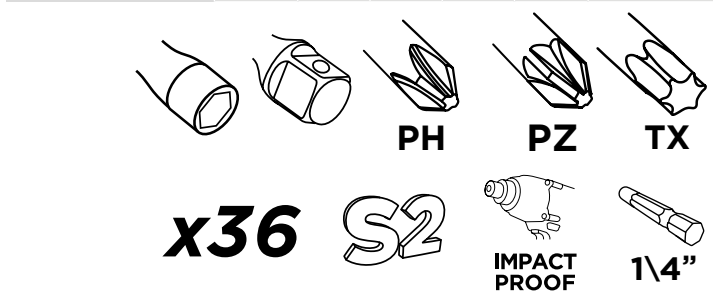

Ref.	Info	📦	📦	EAN
56H560	16 x PH1/2/2/2/3, PZ1/2/2/3, TX10/15/20/25/27/30/40 - 25 mm, 14 x PH1/2/2/2/3, PZ1/2/2/2/3, HEX3/4/5/6 - 50 mm, 3 x 6, 8, 10 mm - 48 mm, 1 x 90 mm, 2 x adapter 1/4", 1/2" - 50 mm	36	0/10	5902062504807

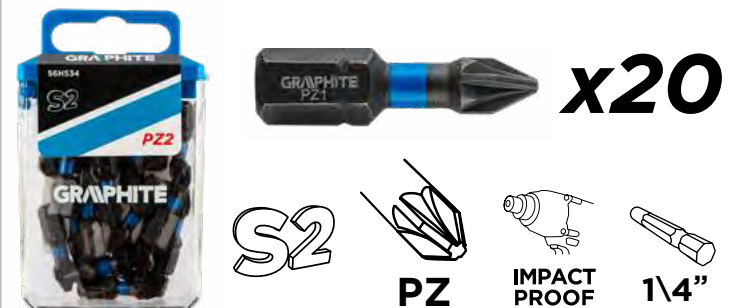

Ref.	Info	L [mm]	📦	📦	EAN
56H533	PZ1	25	20	10/100	5902062504852
56H534	PZ2	25	20	10/100	5902062504869
56H535	PZ3	25	20	10/100	5902062504876
56H536	PZ4	25	20	10/100	5902062504883

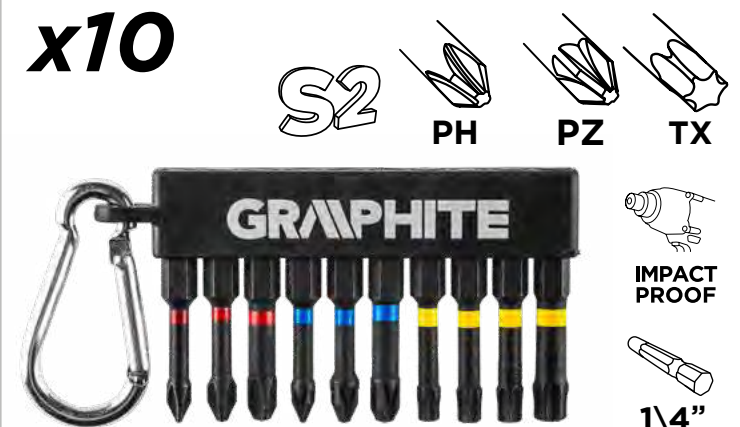

Ref.	Info	L [mm]	📦	📦	EAN
56H562	PH1/PH2/PH3, PZ1/PZ2/PZ3, TX25/TX27/TX30/TX40	50	10	20/80	5902062504814

Końcówki wkrętakowe

Driver bits / Einsätze für Schraubendreher / Насадки / Наконечники викрутки / Csavarhúzó bit / Set biti / Šroubovákové nástavce / Skrutkovacie nástavce / Nastavki za izvijače / Atsuktuvo antgaliai / Skrivgräieža uzgaļi / Kruvikeeraajatsakud / Накрайници за отвертка / Nastavci za odvijač / Nastavci za odvijač / Καταβιδόμετες / Puntas destornilladoras / Punta giravite / Ponteiros Chave de fenda / Embouts de tournevis / Schroevendraaiereinstukken

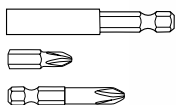

- ⊕ PH2x3, PH3
- ⊕ PZ2x3, PZ3
- ⊖ SL4, SL6
- H4, H5, H6
- T20x2, T25x2, T30x2, T40
- TT10, TT15, TT20, TT25, TT27, TT30, TT40
- ⊕ PH2
- ⊕ PZ2



S2

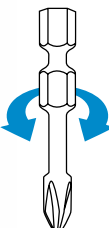

SAFETY FORCE



1/4"

x23

Ref.	📦	📧	EAN
56H612	23	12/48	5902062024473

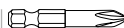

- ⊕ PH1, PH2, PH3
- ⊕ PZ1, PZ2, PZ3
- ⊖ SL3, SL4, SL5, SL6
- H3, H4, H5, H6, H8
- TT10, TT15, T20, T25, T27, T30, T40
- TT10, TT15, TT20, TT25, TT27, TT30, TT40



S2

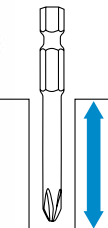

DEEP DRIVE



1/4"

x18

Ref.	📦	📧	EAN
56H606	18	6/24	5902062024442

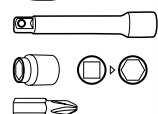

- ⊕ PH1, PH2, PH3
- ⊕ PZ1, PZ2, PZ3
- ⊖ SL4, SL5.5, SL6.5
- H3, H4, H5, H6
- TT10, TT15, T20, T25, T30
- 6, 7, 8, 10, 13 mm



S2



1/4"

x26

Ref.	📦	📧	EAN
56H604	26	6/24	5902062024435

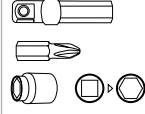
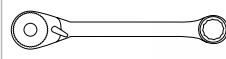

- ⊕ PH1, PH2x2
- ⊕ PZ1, PZ2x2
- H4, H5, H6
- TT10, TT15, T20, T25, T30, T40
- 6, 7, 8, 10, 11, 13 mm



S2



1/4"

x24

Ref.	📦	📧	EAN
56H610	24	12/48	5902062024466

Kątowna nasadka wiertarska

Drill chuck / Bohrfutter / Патрон для дрели / Патрон до дрелию / Fúrótokmány / Mandrină de găurit / Skličidlo pro vrtáky / Slučidlo / Vrtalna glava / Griebtuvas grežtuvai / Urbjmašinas patrona / Drelli padrun / Патрон за бормашина / Stezna glava-bohfuter / Stezna glava-bohfuter / Κεντροσφικτής δράπανου / Portabrocas / Manubrio di trapano per chiave / Suporte de berbequim / Mandrin de perçage / Boorhouder



KĄT 90°
90° ANGLE



max 3000 min⁻¹

Ref.	∅ [mm]	📧	EAN
55H932	0.8 - 10	6/24	5902062000453

Nasadka uniwersalna

Versatile adapter / Universalaufsatz / Универсальная насадка / Універсальна насадка / Univerzális tartó / Ataşament universal / Univerzální nástavec / Univerzálny nadstavec / Univerzalni nastavak / Universalus antgalis / Universāla uzmaņa / Universaalne otsak / Універсальна приставка / Univerzalni nastavak / Univerzalni nasadni ključ / Μύτη γενικής χρήσεως / Llave de vaso universal / Cappuccio universale / Acessório universal / Fixation universelle / Universeeel dop

1/4"-3/4"
7 mm - 19 mm



Ref.	📧	EAN
55H224	1/50	5902062082879



AKCESORIA I GADŻETY MOTORYZACYJNE

automotive
accessories and gadgets

автомобільні аксесуари
та гаджети

Poduszka opona 3D

3D pillow car tyre / 3D-Reifenkissen / 3D подушка для шин / 3D gumiabrons párna / Perna 3D pentru anvelope / 3D polštář pro pneumatiky / 3D vankúš na pneumatiky / 3D blazina za pneumatike / 3D padangos pagalvė / 3D гериу спилвнс / 3D възглавница за гуми / Μαξιλάρι ελαστικών 3D / Cojín de neumático 3D / Cuscino per pneumatici 3D / Almofada de pneu 3D / Coussin de pneu 3D / 3D-bandkussen

ø40
cm



Ref.	☒	EAN
GD023	0/10	5907558484243

Długopis metalowy 5 w 1

Metal pen 5 in 1 / 5-in-1 Metall-Kugelschreiber / Металлическая шариковая ручка 5 в 1 / Металева ручка 5 в 1 / 5 az 1-ben fém golyóstoll / Pix cu bilă din metal 5 în 1 / Kovové kuličkové pero 5 v 1 / Kovové guľôčkové pero 5 v 1 / Kovinsko pisalo 5 v 1 / Metalinis rašiklis "5-in-1/5-in-1 metala lodžiš pildspalva / Метална химикалка 5 в 1 / Μεταλλικό στυλό 5 σε 1 / Bolígrafo metálico 5 en 1 / Penna a sfera in metallo 5 in 1 / Esferográfica de metal 5 em 1 / Stylo à bille en métal 5-en-1 / 5-in-1 metalen balpen



Ref.	☒	EAN
GD024	0/100	5907558484250

Kubek

Mug / Чаша / Миска / Gipszelőedény / Cană / Koflík / Nádoba na sádru PVC / Čaša / Dubuo / Toveris / Tass / Канчок / Pvc posuda / Kadica / Μικρή κούπα / Beker / Bicchiere / Caneca / Bécher

330ml



Ref.	☒	EAN
GD025	6/24	5907558485905
GD026	6/24	5902062093882
GD027	6/24	5907558485912
GD028	6/24	5907558485929

400ml



Ref.	☒	EAN
GD08	0/48	5907558458831

Poduszka podróżna

Car pillow / Tragetasche / Автомобильная подушка / Автомобильна подушка / Autó párna / Pernă pentru mașină / Polštářek do auta / Podložka na prenášanie / Potovalni vzglavnik / Kellonine pagalvė / Ceļojumu spilvens / Възглавница за пътуване / Μαξιλάρι ταξιδιού / Cojín para coche para / Neo tools car cushion / Travesseiro de viagem / Oreiller de voyage / Reiskussen



Ref.	☒	EAN
GD016	0/18	5907558472097

Termos

Vacuum flask / Isolierflasche / Термос / Термос / Termosz / Termos / Termoska / Termoska / Termovka / Termosas / Termoss / Termos / Термос / Termos boca / Termos / Θερμός / Termo / Borraccia termica / Garrafa térmica / Thermos / Thermosfles



Ref.	V[ml]	☒	EAN
GD06	600	0/24	5907558454383
GD07	1000	0/24	5907558454390

GRAPHITE



Ref.	V[ml]	☒	EAN
GD04	800	0/30	5902062025012
GD05	500	0/50	5902062025029



Szczotka skrobaczka samochodowa do śniegu

Car snow scraper brush / Auto-Schneekratzer-Bürste / Автомобильная щетка для скребка снега / Щітка для чищення снігу для автомобіля / Autó hókaparó kefe / Perie de răzuire a zăpezii pentru mașini / Kartáč na škrabání sněhu do auta / Škrabka na sneh do auta / Krtača za strganje snega v avtomobilu / Automobilišnis sniego grandiklio šepetys / Automašinas sniega skrāpja birste / Auto lumekraapjahari / Четка за почистване на сняг за кола / Četka za čiščenje snijega za avtomobil / Автомобилска четка за стругање снега / Βούρτσα ξύστρας χιονίου αυτοκινήτου / Cepillo rascador de nieve para coche / Spazzola raschia-neve per auto / Raspador de neve para automóveis / Brosse à neige pour voiture / Auto sneeuwschraper borstel

60 cm 2 in 1 BRUSH SCRAPER ERGONOMIC HANDLE



Ref.	📦	EAN
GD029	1/24	5907558495287

Zabawki

Toys / Spielsachen / Игрушки / Іграшки / Játékok / Hračky / Hračky / Igrače / Rotallietas / Žaislai / Mänguasjad / Игручки / Juguetes / Giocattoli / Brinquedos / Jouets / Speelgoed



Ref.	📦	EAN
GD010	0/8	5907558459906
GD022	0/18	5907558483130

GRAPHITE



CREATIVE
MANUAL SKILLS

AGE
3+

2x
AA

Ref.	📦	EAN
GD021	0/24	5902062998262

Brelok 6w1

Key ring 6in1 / Schlüsselanhänger 6-in-1 / Кольцо для ключей 6в1 / Брелок для ключів 6в1 / Kulcstartó szerszám 6az1-ben / Breloc 6 în 1 / Přívěsek na klíče 6v1 / Privesok na klúče 6 v 1 / Obesek za ključe 6 v 1 / Raktų pakabukas 6-in-1 / Atslēgu piekariņš 6-in-1 / Ключодержатель 6 в 1 / Μπρελόκ 6 σε 1 / Llavorero 6en1 / Portachiavi 6-in-1 / Chaveiro 6-em-1 / Porte-clés 6-en-1 / Sleutelhanger 6-in-1



Ref.	📦	EAN
GD09	250/1000	5907558459876

Schodek do samochodu 3w1

3-in-1 car stepping tool / Autoeinstiegsstufe 3in1 / Лестница для автомобиля 3 в 1 / Сходи для автомобіля 3-в-1 / Fellépő gépkocsishoz 3az1-ben / Treaptă pentru mașină 3 în 1 / Schodek k autu 3v1 / Schodík do auta / Stopnica za vozilo 3v1 / Automobilio laiptelis 3 viename / Pakāpieni trīs vienā automašīnai / Autoaste 3in1 / Базажник 3в1 / Stupanj za vozilo 3u1 / Stepnica za automobil 3u1 / Σκαλοπάτι αυτοκινήτου 3 σε 1 / Escalón de coche 3 en 1 / Scalino per auto 3in1 / Degrau para carro 3 em 1 / Marche de voiture 3 en 1 / 3-In-1 autotrap / 3-i-1 trinn for bil / Fotsteg till bil 3i1 / Porras autoon 3 in 13v1



FITS MOST CARS
3in1
up to 230kg

Ref.	📦	EAN
10-477	1/50	5907558471120

Urządzenie rozruchowe "Jumpstarter"

Boot device "Jumpstarter" / Startergerät "Jumpstarter" / Зарядное устройство "Jumpstarter" / Завантажувальний пристрій "Jumpstarter" / Boot eszköz "Jumpstarter" / Dispozitiv de pomire „Jumpstarter” / Spouštěcí zařízení „Jumpstarter” / Zavádzacie zariadenie „Jumpstarter” / Zagonška naprava "Jumpstarter" / Įkrovos įrenginys „Jumpstarter” / Sākņēšanas ierīce "Jumpstarter" / Buutimiseade "Jumpstarter" / Стартово устройство "Jumpstarter" / Uredaj za pokretanje "Jumpstarter" / Уреджāj за покретање система "Jumpstarter" / Συσκευή εκκίνησης "Jumpstarter" / Dispositivo de arranque "Jumpstarter" / Dispositivo di avvio "Jumpstarter" / Dispositivo de inicialização "Jumpstarter" / Périphérique de démarrage "Jumpstarter" / Opstartapparaat "Jumpstarter"

14 000 mAh 44.8 W LiFePo4 long life battery MAX 400A (engine start) MAX 3.5 BAR USB 1A / 2A power bank LED light



Ref.	📦	EAN
11-997	1/4	5907558452419

Wielowarstwowy pokrowiec na samochód

A multi-layer car cover / Mehrschichtige Autoabdeckung / Βαζατομαρωτίι αυτομαβιλίνιι χολι / Многослойный автомобильный чехол / Többretegű autónédó / Husá auto multistrat / Vicevstvý potah na auto / Viacrstvový potah na auto / Večplastna prevleka za avto / Keliu sluoksnii / Automobiliá párešgs vairákos slápos / Покривало за кола в няколко слоя / Κάλυμμα αυτοκινήτου πολλαπλών στρώσεων / Copertura per auto multistrato / Funda de coche multicapa / Housse de voiture en plusieurs couches / Cobertura de automóvel em várias camadas / Autohoes in meerdere lagen/



Ref.	📦	EAN
10-474	0/1	5907558471113

Oslona na szybę

Windshield cover / Windschutzscheibenabdeckung / Βικοννα κρυσκα / Чехол для лобового стекла / Szélvédőhuzat / Acoperire parbriz / Obal na čelní sklo / Obal na čelné sklo / Zaščita vetrobranskega stekla / Priekinio stiklo arsauga / Vejistikla aizsargs / Протектор за предно стъкло / Προστατευτικό παμπρίζ / Copri parabrezza / Funda de parabrizas / Protection de pare-brise / Protector de para-brisas / Voorruitbeschermer



Ref.	Info	📦	EAN
10-470	single insulating layer	1/30	5907558471076
10-471	double insulating layer	1/30	5907558471083

Narzędzie wielofunkcyjne płatek śniegu 19 w 1

Snowflake multi-tool 19in1 / Multifunktionswerkzeug Schneeflocke 19 in 1 / Мультиинструмент Снежинка 19в1 / Мультиинструмент Сніжинка 19в1 / Multifunkciós szerszám hópehely 19az1-ben / Instrument multifuncional fulg de zăpadă 19 in 1 / Multifunkční nástroj sněhová vločka 19 v 1 / Multifunkčný nástroj snehová vločka 19 v 1 / Večnamensko orodje snežinka 19 v 1 / Daugiafunkcinis įrankis snaižė 19 in 1 / Daudzfunkcionāls instruments sniegpārslīpa 19 in 1 / Многофункционален инструмент снежинка 19 в 1 / Πολυλειτουργικό εργαλείο χιονοπλάδα 19 σε 1 / Herramienta multifunción copo de nieve 19 en 1 / Strumento multifunzione fiocco di neve 19 in 1 / Floco de neve de ferramenta multifuncional 19 em 1 / Outil multifonctionnel flocon de neige 19 en 1 / Multifunctioneel gereedschap sneeuwvlok 19 in 1



Ref.	📦	EAN
GD015	0/50	5907558465389

Narzędzie wielofunkcyjne

Multipurpose tool / Allzweckwerkzeuge / Инструмент универсальный / Инструмент багатовуникційний / Multiszerszám / Unealta multifuncionala / Multifunkční nástroj / Viacfunkčné náradie / Večfunkcijsko orodje / Daugiafunkciniai įrankiai / Daudzfunkcionālie instrumenti / Multifunktsionaalne tööriist / Мултифункционален инструмент / Višenamjenski uređaj / Višefunkcionalne alatke / Πολυεργαλείο / Herramienta multiuso / Utensile multiuso / Aparelho multifunções / Outil multifonction / Multifunctioneel gereedschap



Ref.	W [mm]	📦	EAN
01-027	105	6/48	5907558420944



Ref.	W [mm]	📦	EAN
01-026	155	6/36	5907558420937



Ref.	W [mm]	📦	EAN
01-028	150	6/36	5907558420951



Ref	p.	Ref	p.	Ref	p.	Ref	p.	Ref	p.	Ref	p.
01-010	93	01-182	91	01-513	104	02-430	106	04-116	84	06-040	87
01-011	93	01-183	91	01-514	104	02-435	105	04-117	84	06-070	87
01-012	93	01-184	91	01-515	104	02-436	105	04-130	89	06-071	87
01-013	93	01-185	91	01-516	104	02-442	106	04-131	89	06-072	87
01-014	93	01-186	91	01-517	104	02-444	105	04-132	89	06-073	87
01-015	93	01-187	91	01-518	103	03-010	107	04-133	89	06-078	87
01-016	93	01-188	91	01-519	101	03-011	107	04-136	89	06-101	86
01-017	94	01-189	91	01-520	101	03-012	107	04-137	89	06-103	86
01-018	94	01-190	91	01-524	100	03-013	107	04-138	89	06-104	86
01-019	94	01-191	91	01-525	98	03-014	107	04-139	89	06-105	86
01-020	94	01-192	91	01-526	179	03-015	107	04-140	89	06-106	86
01-021	95	01-193	91	01-528	179	03-016	107	04-142	90	06-107	70
01-022	95	01-194	91	01-530	103	03-017	107	04-143	89	06-111	85
01-026	233	01-195	91	01-531	103	03-019	107	04-171	79	06-115	84
01-027	233	01-200	105	01-532	102	03-020	107	04-172	79	06-116	84
01-028	233	01-202	104	01-533	102	03-021	107	04-173	79	06-127	85
01-085	96	01-203	105	01-534	101	03-022	107	04-174	79	06-129	85
01-086	96	01-204	104	01-535	90	03-023	107	04-175	79	06-130	85
01-087	96	01-216	96	01-536	102	03-024	107	04-176	79	08-008	63
01-088	96	01-217	96	01-537	102	03-025	107	04-177	79	08-009	63
01-089	96	01-220	97	01-538	101	03-026	107	04-178	79	08-010	63
01-090	96	01-221	97	01-539	102	03-027	107	04-179	79	08-011	63
01-091	96	01-222	97	01-540	101	03-028	107	04-180	79	08-012	63
01-092	96	01-223	97	01-542	101	03-029	107	04-181	79	08-013	63
01-093	96	01-224	97	01-543	103	03-030	78	04-182	80	08-014	63
01-094	96	01-225	97	01-550	99	03-031	78	04-183	80	08-015	63
01-095	96	01-226	98	01-551	99	04-001	79	04-184	80	08-016	63
01-096	96	01-227	98	01-555	103	04-002	79	04-185	80	08-017	63
01-097	96	01-228	98	01-600	179	04-004	79	04-186	80	08-018	63
01-101	94	01-229	99	01-601	179	04-006	79	04-187	80	08-019	63
01-102	95	01-231	98	01-602	179	04-007	79	04-188	80	08-020	63
01-103	95	01-232	98	01-603	179	04-011	79	04-189	80	08-021	63
01-105	94	01-233	98	01-604	179	04-012	79	04-190	80	08-022	63
01-106	95	01-234	100	01-605	179	04-013	79	04-191	82	08-023	63
01-110	91	01-235	99	01-606	179	04-014	79	04-192	82	08-024	63
01-111	91	01-236	99	01-607	179	04-015	79	04-193	82	08-025	63
01-112	91	01-237	100	01-608	179	04-016	79	04-194	82	08-026	63
01-113	91	01-240	97	01-609	179	04-019	80	04-196	83	08-027	63
01-114	91	01-241	97	01-610	179	04-020	80	04-197	83	08-028	63
01-115	91	01-242	97	01-611	179	04-021	79	04-200	88	08-029	63
01-116	91	01-243	98	01-612	179	04-022	79	04-201	82	08-030	63
01-117	91	01-244	98	01-613	179	04-023	79	04-204	81	08-032	63
01-118	91	01-245	99	01-614	179	04-024	79	04-206	81	08-036	63
01-119	91	01-250	93	02-001	73	04-025	79	04-207	81	08-039	63
01-120	91	01-251	93	02-005	106	04-026	79	04-208	81	08-040	63
01-122	91	01-252	93	02-010	106	04-028	80	04-209	83	08-041	63
01-123	91	01-253	93	02-040	106	04-031	80	04-210	83	08-042	63
01-124	91	01-254	93	02-041	106	04-032	80	04-211	83	08-043	63
01-125	91	01-255	93	02-042	106	04-033	80	04-212	82	08-044	63
01-126	91	01-256	94	02-044	106	04-034	80	04-213	81	08-045	63
01-127	91	01-257	94	02-106	105	04-035	80	04-214	81	08-046	63
01-128	91	01-306	91	02-107	105	04-036	80	04-220	89	08-047	63
01-129	91	01-307	91	02-111	105	04-037	88	04-221	90	08-048	63
01-150	95	01-308	90	02-112	105	04-044	80	04-222	90	08-049	63
01-151	95	01-309	90	02-401	105	04-045	80	04-225	83	08-050	63
01-152	93	01-310	92	02-402	106	04-046	80	04-228	85	08-051	63
01-153	93	01-311	92	02-403	106	04-051	89	04-231	88	08-052	63
01-154	93	01-400	100	02-406	106	04-052	89	04-240	80	08-053	63
01-155	93	01-401	104	02-407	106	04-053	89	04-250	88	08-054	63
01-156	94	01-402	73	02-407	106	04-054	89	04-618	209	08-055	63
01-157	94	01-500	101	02-407	106	04-055	89	04-620	214	08-056	63
01-158	94	01-501	102	02-409	106	04-062	89	04-705	28	08-058	63
01-171	91	01-502	102	02-412	105	04-063	89	04-710	212	08-061	42
01-172	91	01-503	103	02-413	105	04-071	89	04-730	27	08-070	63
01-173	91	01-506	102	02-415	105	04-072	89	04-731	27	08-071	63
01-175	91	01-507	102	02-416	105	04-073	89	04-732	27	08-072	63
01-176	91	01-509	95	02-417	105	04-112	84	06-011	87	08-073	63
01-177	91	01-510	104	02-418	105	04-113	84	06-020	87	08-074	63
01-180	90	01-511	103	02-419	105	04-114	84	06-036	87	08-075	63
01-181	91	01-512	104	02-429	106	04-115	84	06-037	87	08-076	63



Ref	p.	Ref	p.	Ref	p.	Ref	p.	Ref	p.	Ref	p.	Ref	p.
08-077	63	08-251	66	08-444	61	08-546	65	08-755	68	09-044	76		
08-078	63	08-252	66	08-446	61	08-550	66	08-756	68	09-045	76		
08-080	63	08-253	66	08-447	61	08-551	66	08-757	68	09-051	76		
08-081	63	08-254	66	08-448	61	08-552	66	08-758	68	09-052	76		
08-082	63	08-255	66	08-449	61	08-553	66	08-759	68	09-053	76		
08-083	63	08-256	66	08-450	61	08-554	66	08-760	68	09-054	76		
08-084	63	08-257	74	08-451	61	08-555	66	08-761	68	09-055	76		
08-085	63	08-300	63	08-452	61	08-556	66	08-762	68	09-056	76		
08-086	63	08-301	63	08-453	61	08-557	66	08-763	68	09-057	76		
08-090	136	08-302	63	08-454	61	08-558	66	08-764	68	09-058	76		
08-091	136	08-304	63	08-458	62	08-559	66	08-765	68	09-059	76		
08-151	66	08-306	63	08-459	62	08-560	66	08-766	68	09-060	76		
08-152	66	08-307	63	08-460	62	08-562	66	08-767	68	09-061	76		
08-153	66	08-308	63	08-461	62	08-563	66	08-770	67	09-062	76		
08-154	66	08-309	63	08-462	62	08-564	66	08-771	67	09-063	76		
08-155	66	08-311	63	08-463	62	08-565	66	08-772	67	09-064	76		
08-168	62	08-312	63	08-464	62	08-580	64	08-773	67	09-065	76		
08-170	62	08-313	63	08-465	62	08-581	64	08-774	67	09-066	76		
08-171	62	08-314	63	08-466	62	08-582	64	08-775	67	09-067	76		
08-172	62	08-315	63	08-467	62	08-583	64	08-776	67	09-068	76		
08-173	62	08-316	63	08-468	62	08-584	64	08-777	67	09-069	76		
08-174	62	08-319	63	08-469	62	08-585	64	08-778	67	09-141	77		
08-175	62	08-320	64	08-470	62	08-586	64	08-780	67	09-143	77		
08-176	62	08-321	64	08-471	62	08-587	64	08-781	67	09-145	77		
08-177	62	08-322	64	08-472	62	08-588	64	08-782	67	09-147	77		
08-178	62	08-323	64	08-473	62	08-589	64	08-783	67	09-149	77		
08-179	62	08-324	64	08-474	62	08-590	64	08-784	67	09-151	77		
08-180	62	08-325	64	08-475	62	08-591	64	08-821	74	09-176	78		
08-181	62	08-326	64	08-476	62	08-592	64	08-822	74	09-203	79		
08-182	62	08-327	64	08-477	62	08-593	64	08-823	74	09-205	79		
08-184	62	08-328	64	08-478	62	08-594	64	08-824	74	09-208	79		
08-185	62	08-329	64	08-479	62	08-595	64	08-825	74	09-212	79		
08-186	62	08-331	64	08-480	62	08-596	64	08-826	74	09-214	79		
08-187	62	08-332	64	08-482	62	08-597	64	08-827	74	09-302	79		
08-188	62	08-333	64	08-486	62	08-598	64	08-828	74	09-320	76		
08-189	62	08-335	64	08-487	61	08-599	64	08-830	75	09-321	76		
08-190	62	08-340	63	08-488	61	08-603	61	08-835	74	09-322	76		
08-191	62	08-341	63	08-489	61	08-649	70	08-837	74	09-323	76		
08-192	62	08-350	66	08-490	61	08-650	64	08-838	74	09-324	76		
08-193	62	08-351	66	08-491	61	08-651	64	08-839	74	09-325	76		
08-194	62	08-352	66	08-492	61	08-690	41	08-843	74	09-326	76		
08-195	62	08-353	66	08-493	61	08-692	40	08-845	74	09-327	76		
08-196	62	08-355	65	08-494	61	08-694	40	08-910	48	09-328	76		
08-197	62	08-356	66	08-495	61	08-705	68	08-915	46	09-329	76		
08-220	61	08-357	66	08-497	61	08-706	68	08-920	60	09-330	76		
08-221	61	08-408	62	08-498	61	08-707	69	08-960	225	09-331	76		
08-222	61	08-409	62	08-499	61	08-708	69	08-961	225	09-333	76		
08-223	61	08-410	62	08-501	65	08-710	70	08-962	225	09-334	76		
08-224	61	08-411	62	08-502	65	08-711	69	08-963	225	09-336	76		
08-225	61	08-412	62	08-503	65	08-712	150	08-964	225	09-338	76		
08-226	61	08-413	62	08-504	65	08-713	69	08-965	225	09-339	76		
08-227	61	08-414	62	08-507	65	08-730	67	08-966	225	09-340	76		
08-228	61	08-415	62	08-508	65	08-731	67	08-967	225	09-341	76		
08-229	61	08-416	62	08-511	65	08-732	67	08-968	225	09-342	76		
08-230	61	08-417	62	08-512	65	08-733	67	08-969	225	09-345	77		
08-231	61	08-418	62	08-513	65	08-734	67	08-970	225	09-360	78		
08-232	61	08-419	62	08-514	65	08-735	67	08-971	225	09-361	78		
08-235	61	08-421	62	08-515	65	08-736	67	08-972	225	09-362	78		
08-236	61	08-422	62	08-516	65	08-740	67	08-973	225	09-363	78		
08-237	61	08-423	62	08-519	65	08-741	67	08-974	225	09-364	78		
08-238	61	08-424	62	08-520	65	08-742	67	08-975	225	09-365	78		
08-239	61	08-425	62	08-521	65	08-743	67	08-976	225	09-366	78		
08-240	61	08-426	62	08-523	65	08-744	67	08-977	225	09-367	78		
08-241	61	08-427	62	08-524	65	08-745	67	08-978	225	09-368	78		
08-242	61	08-429	62	08-525	65	08-746	67	08-979	225	09-370	78		
08-243	61	08-430	62	08-530	64	08-750	68	08-980	225	09-406	75		
08-244	61	08-431	62	08-533	64	08-751	68	08-981	225	09-407	75		
08-245	61	08-432	62	08-536	64	08-752	68	08-982	225	09-408	75		
08-246	61	08-442	61	08-540	65	08-753	68	09-042	76	09-409	75		
08-247	61	08-443	61	08-543	65	08-754	68	09-043	76	09-410	75		



Ref	p.	Ref	p.	Ref	p.	Ref	p.	Ref	p.	Ref	p.
09-411	75	09-654	75	09-812	77	10-263	149	10-503	160	11-024	97
09-412	75	09-655	75	09-814	77	10-264	149	10-504	160	11-030	175
09-413	75	09-656	75	09-816	77	10-265	149	10-505	161	11-100	117
09-414	75	09-657	75	09-817	77	10-300	64	10-506	161	11-101	117
09-415	75	09-658	75	09-818	77	10-310	67	10-507	161	11-102	117
09-416	75	09-659	75	09-819	77	10-311	67	10-508	162	11-111	117
09-417	75	09-660	75	09-820	77	10-312	67	10-509	161	11-112	117
09-418	75	09-661	75	09-821	77	10-313	67	10-510	161	11-113	118
09-419	75	09-662	75	09-824	77	10-314	67	10-511	161	11-122	115
09-421	75	09-663	75	09-825	77	10-315	67	10-569	162	11-123	115
09-422	75	09-665	75	09-851	77	10-316	67	10-570	162	11-125	115
09-424	75	09-666	75	09-852	77	10-317	67	10-571	162	11-126	115
09-427	75	09-668	75	09-860	77	10-318	67	10-572	162	11-127	115
09-429	75	09-671	75	09-890	20	10-319	67	10-573	162	11-128	115
09-430	75	09-672	75	09-906	78	10-320	67	10-574	162	11-129	115
09-432	75	09-674	75	09-908	78	10-321	67	10-575	162	11-130	116
09-512	72	09-675	75	09-910	78	10-322	68	10-576	162	11-131	116
09-514	72	09-706	75	09-912	78	10-323	68	10-577	162	11-132	116
09-515	72	09-707	75	09-914	78	10-324	68	10-578	162	11-135	116
09-516	73	09-708	75	09-916	78	10-325	68	10-579	162	11-152	136
09-517	72	09-709	75	09-918	78	10-326	68	10-580	162	11-153	136
09-518	73	09-710	75	09-920	78	10-327	68	10-581	162	11-165	136
09-523	71	09-711	75	09-921	78	10-328	68	10-582	162	11-167	134
09-524	72	09-712	75	09-924	78	10-329	67	10-583	162	11-168	134
09-525	71	09-713	75	09-930	78	10-330	67	10-584	162	11-169	134
09-526	73	09-714	75	09-952	78	10-331	67	10-585	162	11-170	132
09-530	71	09-715	75	09-980	78	10-332	67	10-586	162	11-171	132
09-531	71	09-716	75	10-000	40	10-333	67	10-587	162	11-190	137
09-532	71	09-717	75	10-004	41	10-334	67	10-588	163	11-191	137
09-533	71	09-718	75	10-006	41	10-335	67	10-590	163	11-192	137
09-534	71	09-719	75	10-008	42	10-336	67	10-596	163	11-203	131
09-535	71	09-720	75	10-020	40	10-337	67	10-600	159	11-204	131
09-536	71	09-721	75	10-030	40	10-338	67	10-602	163	11-205	131
09-537	71	09-722	75	10-032	43	10-339	67	10-606	164	11-218	132
09-538	71	09-723	75	10-036	42	10-340	68	10-700	152	11-221	133
09-539	71	09-724	75	10-038	43	10-341	68	10-701	152	11-222	133
09-540	71	09-725	75	10-042	44	10-342	68	10-800	113	11-223	133
09-541	71	09-727	75	10-054	45	10-343	68	10-801	113	11-224	133
09-542	71	09-728	75	10-058	44	10-344	68	10-802	114	11-226	133
09-543	71	09-729	75	10-059	45	10-345	68	10-803	114	11-227	133
09-544	71	09-730	75	10-060	47	10-346	68	10-804	114	11-228	133
09-545	71	09-732	75	10-062	47	10-401	181	10-805	114	11-231	112
09-546	71	09-734	75	10-066	53	10-402	181	10-806	114	11-235	112
09-550	72	09-736	75	10-070	53	10-403	181	10-807	114	11-237	111
09-551	72	09-738	75	10-072	51	10-404	181	10-900	71	11-238	112
09-552	72	09-741	75	10-074	52	10-405	181	10-902	71	11-239	111
09-553	72	09-746	75	10-076	55	10-406	181	10-904	71	11-240	112
09-554	72	09-747	75	10-078	56	10-407	181	10-906	71	11-241	112
09-555	72	09-749	75	10-196	59	10-408	181	10-908	71	11-242	111
09-556	72	09-750	76	10-200	58	10-450	24	10-910	71	11-243	111
09-557	72	09-751	76	10-202	58	10-451	24	10-920	71	11-250	134
09-558	72	09-752	76	10-206	49	10-452	24	10-922	71	11-261	135
09-559	72	09-753	76	10-208	50	10-453	24	10-924	71	11-262	135
09-570	61	09-754	76	10-210	50	10-454	24	10-926	71	11-263	135
09-571	72	09-760	76	10-212	49	10-455	24	10-928	71	11-264	135
09-573	73	09-761	76	10-216	54	10-456	24	10-940	71	11-265	136
09-575	227	09-762	76	10-218	57	10-470	233	10-942	71	11-266	136
09-576	227	09-763	76	10-250	150	10-471	233	10-944	71	11-267	134
09-577	227	09-764	76	10-251	150	10-472	159	10-946	71	11-270	138
09-578	227	09-765	76	10-252	150	10-473	159	10-948	71	11-299	130
09-579	227	09-766	76	10-253	150	10-474	233	10-960	71	11-300	125
09-580	227	09-767	76	10-254	150	10-477	232	10-970	71	11-301	125
09-584	227	09-768	76	10-255	150	10-478	23	10-972	71	11-302	125
09-585	227	09-769	76	10-256	150	10-480	159	10-978	71	11-303	125
09-587	227	09-770	76	10-257	150	10-481	159	10-980	71	11-304	125
09-588	227	09-771	76	10-258	149	10-482	159	10-982	71	11-305	126
09-650	75	09-791	76	10-259	149	10-485	26	10-988	71	11-306	125
09-651	75	09-806	77	10-260	149	10-500	160	11-020	97	11-307	126
09-652	75	09-808	77	10-261	149	10-501	160	11-021	97	11-310	126
09-653	75	09-810	77	10-262	149	10-502	160	11-022	97	11-311	127



Ref	p.	Ref	p.	Ref	p.	Ref	p.	Ref	p.	Ref	p.
11-312	126	11-730	24	11-905	122	12-317	149	14-034	147	19-153	142
11-313	126	11-731	24	11-906	122	12-319	149	14-036	154	19-200	141
11-314	127	11-732	24	11-907	122	12-321	149	14-220	155	19-220	141
11-315	127	11-749	25	11-908	122	12-322	149	14-500	144	19-225	141
11-316	127	11-750	23	11-909	122	12-324	149	14-502	144	19-250	141
11-317	127	11-751	23	11-915	122	12-350	151	14-508	146	19-904	141
11-320	127	11-760	23	11-920	137	12-600	152	14-510	146	19-905	141
11-321	128	11-761	23	11-922	138	12-601	152	14-514	146	19-906	141
11-322	128	11-762	23	11-925	138	12-602	152	14-550	151	20-021	139
11-323	128	11-763	23	11-931	122	12-605	153	14-552	153	20-022	139
11-324	128	11-796	117	11-950	176	12-606	153	14-570	148	20-025	140
11-325	128	11-797	118	11-952	176	12-610	152	14-572	148	20-026	140
11-326	128	11-798	117	11-953	176	12-611	152	14-610	148	20-030	140
11-330	129	11-799	119	11-956	176	12-612	152	14-611	148	20-033	140
11-331	129	11-801	118	11-960	176	12-613	152	14-612	148	20-036	140
11-332	129	11-802	118	11-961	176	12-615	152	14-613	148	20-040	140
11-333	129	11-803	118	11-963	176	12-616	152	14-614	148	20-041	140
11-334	130	11-804	118	11-969	178	12-617	152	14-615	148	20-045	139
11-335	129	11-805	118	11-970	175	12-618	152	14-620	148	55H010	216
11-336	129	11-806	118	11-971	177	12-620	152	14-621	148	55H013	216
11-337	130	11-807	118	11-972	177	12-621	152	14-622	148	55H014	216
11-338	126	11-808	118	11-973	177	12-622	152	14-623	148	55H015	216
11-360	111	11-810	119	11-974	177	12-623	152	14-624	148	55H016	216
11-361	111	11-811	119	11-975	176	12-625	153	14-625	148	55H017	216
11-362	111	11-812	121	11-976	178	12-626	153	14-626	148	55H018	216
11-363	111	11-813	121	11-977	178	12-627	153	14-627	148	55H019	216
11-364	111	11-816	119	11-978	178	12-628	153	14-628	148	55H020	216
11-365	111	11-817	137	11-979	177	12-630	152	14-629	148	55H021	216
11-366	111	11-819	137	11-980	177	12-631	152	14-630	148	55H022	216
11-367	111	11-822	175	11-981	175	12-632	152	14-631	148	55H024	216
11-368	111	11-823	175	11-983	178	12-635	152	14-650	148	55H025	216
11-369	111	11-824	175	11-984	123	12-636	152	14-651	148	55H026	216
11-370	111	11-825	175	11-985	123	12-637	152	14-652	148	55H027	216
11-371	111	11-827	137	11-986	123	12-640	153	14-653	148	55H029	216
11-372	111	11-832	124	11-991	179	12-641	153	14-654	148	55H030	216
11-373	111	11-834	123	11-992	179	12-645	152	14-655	148	55H031	216
11-380	112	11-836	123	11-993	178	12-646	152	14-656	148	55H033	216
11-381	112	11-847	119	11-997	232	12-650	152	14-657	148	55H034	216
11-382	112	11-848	121	12-070	151	12-651	152	14-658	148	55H035	216
11-383	113	11-850	120	12-071	151	12-655	153	14-699	155	55H036	216
11-384	113	11-851	120	12-072	151	12-656	153	14-700	155	55H038	216
11-400	175	11-852	120	12-074	151	12-908	123	14-702	155	55H039	216
11-401	175	11-857	120	12-075	151	12-909	122	14-703	155	55H040	216
11-402	175	11-858	120	12-076	151	12-910	123	14-704	155	55H224	229
11-403	175	11-859	120	12-079	151	12-915	122	14-706	156	55H320	219
11-404	175	11-861	120	12-080	151	12K010	154	14-708	154	55H350	218
11-500	114	11-862	120	12-081	151	12K020	153	14-710	154	55H351	218
11-510	113	11-865	120	12-101	149	12K021	153	14-712	154	55H352	218
11-511	113	11-866	120	12-102	149	12K022	153	14-714	156	55H353	218
11-532	114	11-867	120	12-105	149	12K030	154	14-716	156	55H354	218
11-550	113	11-868	120	12-107	149	12K031	154	14-718	157	55H355	218
11-555	114	11-869	120	12-110	149	14-002	144	14-720	156	55H356	218
11-560	114	11-870	120	12-115	149	14-004	144	14-722	156	55H357	218
11-561	114	11-871	120	12-210	149	14-006	144	14-724	156	55H358	218
11-600	25	11-872	120	12-212	149	14-008	144	14-730	151	55H359	218
11-601-1	25	11-873	120	12-213	149	14-010	145	14-732	151	55H360	218
11-610	138	11-880	130	12-214	149	14-012	145	14-734	150	55H361	218
11-611	138	11-881	130	12-215	149	14-013	146	14-800	151	55H362	218
11-612	138	11-882	130	12-216	149	14-014	145	14-802	151	55H363	218
11-614	138	11-883	131	12-217	149	14-016	145	14-804	151	55H364	218
11-690	121	11-884	131	12-219	149	14-017	147	14-806	151	55H365	218
11-691	121	11-885	132	12-221	149	14-018	145	14-808	151	55H366	218
11-710	25	11-890	124	12-222	149	14-019	145	14-820	157	55H367	218
11-711	25	11-891-1	124	12-224	149	14-020	146	18-101	139	55H368	218
11-712	25	11-892-1	124	12-310	149	14-026	146	18-102	139	55H369	218
11-714	26	11-893-1	124	12-312	149	14-028	147	18-103	139	55H370	218
11-716	26	11-901	122	12-313	149	14-029	147	18-106	139	55H371	218
11-718	26	11-902	122	12-314	149	14-030	147	18-107	139	55H372	218
11-719	26	11-903	122	12-315	149	14-031	147	19-151	142	55H373	218
11-720	23	11-904	122	12-316	149	14-032	147	19-152	142	55H374	218



Ref	p.	Ref	p.	Ref	p.	Ref	p.	Ref	p.	Ref	p.
55H375	219	55H913	222	56H513	226	57H034	216	57H903	217	61-006	142
55H376	219	55H914	222	56H514	226	57H034-10	216	57H904	217	63-011	108
55H377	219	55H915	222	56H515	226	57H036	216	57H905	217	63-012	107
55H570	217	55H916	222	56H516	226	57H036-10	216	57H906	217	63-013	107
55H572	217	55H917	222	56H517	226	57H038	216	57H907	217	63-014	108
55H574	217	55H918	222	56H518	227	57H038-10	216	57H908	217	63-021	108
55H576	217	55H919	222	56H519	227	57H040	216	57H909	217	63-050	107
55H754	221	55H920	222	56H520	227	57H040-10	216	57H910	217	63-060	107
55H755	221	55H921	222	56H521	227	57H042	216	57H911	217	63-700	108
55H756	221	55H922	222	56H522	227	57H042-10	216	57H912	217	63-702	108
55H757	221	55H923	222	56H523	227	57H044	216	57H913	217	63-710	109
55H758	221	55H924	222	56H524	227	57H046	216	57H914	217	64-001	109
55H759	221	55H925	222	56H525	227	57H046-5	216	57H915	217	64-010	109
55H760	221	55H926	222	56H526	227	57H048	216	57H916	217	64-012	108
55H761	221	55H927	222	56H527	227	57H048-5	216	57H917	217	64-013	108
55H762	221	55H928	219	56H528	227	57H050	216	57H918	217	64-014	108
55H763	222	55H929	219	56H529	227	57H050-5	216	57H919	217	64-015	109
55H764	222	55H932	229	56H530	228	57H052	216	57H920	217	64-020	108
55H765	222	55H933	220	56H531	228	57H054	216	57H922	217	64-210	109
55H766	222	55H934	220	56H532	228	57H054-5	216	57H924	217	64-220	109
55H767	222	55H935	220	56H533	228	57H055	216	57H926	217	64-410	109
55H768	222	55H936	220	56H534	228	57H056	216	57H928	217	64-420	109
55H823	219	55H937	220	56H535	228	57H056-5	216	57H930	217	64-610	109
55H824	219	55H938	220	56H536	228	57H058	216	57H932	217	64-620	109
55H825	219	55H939	220	56H540	228	57H058-5	216	57H934	217	81-210-L	188
55H826	219	55H940	220	56H541	228	57H062	216	57H936	217	81-210-LD	188
55H827	219	55H941	220	56H542	227	57H062-5	216	57H938	217	81-210-M	188
55H855	220	55H942	220	56H543	227	57H064	216	57H940	217	81-210-S	188
55H856	220	55H943	220	56H544	228	57H066	216	57H944	217	81-210-XL	188
55H857	220	55H944	220	56H545	228	57H066-5	216	57H947	223	81-210-XXL	188
55H858	220	55H980	220	56H546	228	57H086	216	57H948	223	81-214-L	187
55H859	220	55H981	220	56H547	228	57H088	216	57H950	223	81-214-M	187
55H873	222	55H982	220	56H554	226	57H089	216	57H951	223	81-214-S	187
55H874	222	55H983	220	56H555	226	57H090	216	57H952	223	81-214-XL	187
55H875	222	55H984	220	56H556	226	57H250	218	57H953	223	81-214-XXL	187
55H876	222	55H985	220	56H557	226	57H581	221	57H954	223	81-214-XXXL	187
55H877	222	55H986	220	56H558	226	57H582	221	58G001	215	81-215-L	188
55H878	222	55H987	220	56H560	228	57H583	221	58G002	215	81-215-M	188
55H879	222	55H988	220	56H562	228	57H585	221	58G004	215	81-215-S	188
55H880	222	55H989	220	56H604	229	57H587	221	58G007	213	81-215-XL	188
55H881	222	55H990	220	56H606	229	57H589	221	58G010	208	81-215-XXL	188
55H882	222	55H991	220	56H610	229	57H591	221	58G012	209	81-216-L	187
55H884	222	55H992	219	56H612	229	57H592	221	58G017	213	81-216-M	187
55H885	222	56-040	179	56H650	223	57H596	221	58G018	209	81-216-S	187
55H886	222	56H006	224	56H655	223	57H598	221	58G019	208	81-216-XL	187
55H887	222	56H010	224	57G100	214	57H599	221	58G024	209	81-216-XXL	187
55H888	222	56H012	224	57H010	216	57H600	221	58G025	214	81-216-XXXL	187
55H889	222	56H013	224	57H012	216	57H601	221	58G028	209	81-217-L	187
55H890	222	56H014	224	57H014	216	57H602	221	58G038	209	81-217-M	187
55H891	222	56H048	223	57H014-10	216	57H700	217	58G040	212	81-217-S	187
55H892	222	56H055	224	57H015	216	57H705	217	58G041	214	81-217-XL	187
55H893	222	56H056	224	57H016	216	57H719	217	58G085	215	81-217-XS	187
55H894	222	56H057	224	57H018	216	57H739	217	58G086	215	81-217-XXL	187
55H896	222	56H061	224	57H018-10	216	57H740	217	58G092	215	81-217-XXXL	187
55H897	222	56H072	224	57H020	216	57H741	217	58G904	27	81-218-L	188
55H898	222	56H246	218	57H020-10	216	57H835	220	58G961	213	81-218-M	188
55H899	222	56H420	224	57H022	216	57H836	220	59G383	214	81-218-S	188
55H900	222	56H500	226	57H022-10	216	57H837	220	59G522	212	81-218-XL	188
55H901	222	56H501	226	57H023	216	57H838	220	59G523	212	81-218-XXL	188
55H902	222	56H502	226	57H023-10	216	57H839	220	59G526	212	81-218-XXXL	188
55H903	222	56H503	226	57H024	216	57H840	220	59G607	27	81-220-L	185
55H904	222	56H504	226	57H024-10	216	57H841	220	59G608	27	81-220-LD	185
55H905	222	56H505	226	57H026	216	57H842	220	59G610	27	81-220-M	185
55H906	222	56H506	226	57H026-10	216	57H843	220	59G620	28	81-220-S	185
55H907	222	56H507	226	57H028	216	57H844	220	59G621	28	81-220-XL	185
55H908	222	56H508	226	57H028-10	216	57H845	220	59G873	213	81-220-XXL	185
55H909	222	56H509	226	57H030	216	57H860	220	61-001	142	81-225-L	186
55H910	222	56H510	226	57H030-10	216	57H900	217	61-002	142	81-225-M	186
55H911	222	56H511	226	57H032	216	57H901	217	61-004	142	81-225-S	186
55H912	222	56H512	226	57H032-10	216	57H902	217	61-005	142	81-225-XL	186



Ref	p.	Ref	p.	Ref	p.	Ref	p.	Ref	p.	Ref	p.	Ref	p.
81-225-XXL	186	81-239-L	185	81-420-XXL	186	81-534-L	192	81-606-S	192	81-659-XL	192	81-659-XL	192
81-226-L	183	81-239-M	185	81-430-L	186	81-534-M	192	81-606-XL	192	81-659-XXL	192	81-659-XXL	192
81-226-M	183	81-239-S	185	81-430-LD	186	81-534-S	192	81-606-XXL	192	81-659-XXXL	192	81-659-XXXL	192
81-226-S	183	81-239-XL	185	81-430-M	186	81-534-XL	192	81-606-XXXL	192	81-660-L/XL	194	81-660-L/XL	194
81-226-XL	183	81-239-XS	185	81-430-S	186	81-534-XXL	192	81-609-L	190	81-660-S/M	194	81-660-S/M	194
81-226-XS	183	81-239-XXL	185	81-430-XL	186	81-534-XXXL	192	81-609-M	190	81-660-XXL/XXXL	194	81-660-XXL/XXXL	194
81-226-XXL	183	81-239-XXXL	185	81-430-XXL	186	81-540-L	193	81-609-S	190	81-661-L/XL	194	81-661-L/XL	194
81-226-XXXL	183	81-240-L	185	81-450-L	187	81-540-M	193	81-609-XL	190	81-661-S/M	194	81-661-S/M	194
81-227-L	183	81-240-LD	185	81-450-M	187	81-540-S	193	81-609-XXL	190	81-661-XXL/XXXL	194	81-661-XXL/XXXL	194
81-227-M	183	81-240-M	185	81-450-S	187	81-540-XL	193	81-609-XXXL	190	81-662-L/XL	194	81-662-L/XL	194
81-227-S	183	81-240-S	185	81-450-XL	187	81-540-XXL	193	81-610-L	191	81-662-S/M	194	81-662-S/M	194
81-227-XL	183	81-240-XL	185	81-450-XXL	187	81-541-L	193	81-610-M	191	81-662-XXL/XXXL	194	81-662-XXL/XXXL	194
81-227-XS	183	81-240-XXL	185	81-450-XXXL	187	81-541-M	193	81-610-S	191	81-663-L/XL	194	81-663-L/XL	194
81-227-XXL	183	81-245-L	186	81-451-L	186	81-541-S	193	81-610-XL	191	81-663-S/M	194	81-663-S/M	194
81-227-XXXL	183	81-245-M	186	81-451-M	186	81-541-XL	193	81-610-XXL	191	81-663-XXL/XXXL	194	81-663-XXL/XXXL	194
81-228-L	184	81-245-S	186	81-451-S	186	81-541-XXL	193	81-612-L	191	81-670-L/XL	194	81-670-L/XL	194
81-228-M	184	81-245-XL	186	81-451-XL	186	81-545-L	193	81-612-M	191	81-670-S/M	194	81-670-S/M	194
81-228-S	184	81-245-XXL	186	81-451-XXL	186	81-545-M	193	81-612-S	191	81-670-XXL/XXXL	194	81-670-XXL/XXXL	194
81-228-XL	184	81-246-L	183	81-451-XXXL	186	81-545-S	193	81-612-XL	191	81-671-L/XL	194	81-671-L/XL	194
81-228-XS	184	81-246-M	183	81-500-L	188	81-545-XL	193	81-612-XXL	191	81-671-S/M	194	81-671-S/M	194
81-228-XXL	184	81-246-S	183	81-500-M	188	81-545-XXL	193	81-615-L	192	81-671-XXL/XXXL	194	81-671-XXL/XXXL	194
81-228-XXXL	184	81-246-XL	183	81-500-S	188	81-545-XXXL	193	81-615-M	192	81-672-L/XL	194	81-672-L/XL	194
81-229-L	184	81-246-XS	183	81-500-XL	188	81-546-L	193	81-615-S	192	81-672-S/M	194	81-672-S/M	194
81-229-M	184	81-246-XXL	183	81-500-XXL	188	81-546-M	193	81-615-XL	192	81-672-XXL/XXXL	194	81-672-XXL/XXXL	194
81-229-S	184	81-246-XXXL	183	81-501-L	189	81-546-S	193	81-615-XXL	192	81-673-L/XL	194	81-673-L/XL	194
81-229-XL	184	81-247-L	183	81-501-M	189	81-546-XL	193	81-621	195	81-673-S/M	194	81-673-S/M	194
81-229-XS	184	81-247-M	183	81-501-S	189	81-546-XXL	193	81-630	195	81-673-XXL/XXXL	194	81-673-XXL/XXXL	194
81-229-XXL	184	81-247-S	183	81-501-XL	189	81-546-XXXL	193	81-631	195	81-900	202	81-900	202
81-229-XXXL	184	81-247-XL	183	81-501-XXL	189	81-549-L	193	81-632	195	82-010	195	82-010	195
81-230-L	185	81-247-XS	183	81-502-L	189	81-549-M	193	81-640-L	190	82-011	195	82-011	195
81-230-LD	185	81-247-XXL	183	81-502-M	189	81-549-S	193	81-640-M	190	82-012	195	82-012	195
81-230-M	185	81-247-XXXL	183	81-502-S	189	81-549-XL	193	81-640-XL	190	82-013	195	82-013	195
81-230-S	185	81-248-L	185	81-502-XL	189	81-549-XXL	193	81-640-XXL	190	82-014	195	82-014	195
81-230-XL	185	81-248-M	185	81-502-XXL	189	81-549-XXXL	193	81-640-XXXL	190	82-015	195	82-015	195
81-230-XXL	185	81-248-S	185	81-502-XXXL	189	81-550-L	190	81-641-L	191	82-016	195	82-016	195
81-231-L	184	81-248-XL	185	81-503-L	189	81-550-M	190	81-641-M	191	82-017	195	82-017	195
81-231-M	184	81-248-XS	185	81-503-M	189	81-550-S	190	81-641-XXL	191	82-018	195	82-018	195
81-231-S	184	81-248-XXL	185	81-503-S	189	81-550-XL	190	81-641-XXXL	191	82-020	197	82-020	197
81-231-XL	184	81-248-XXXL	185	81-503-XL	189	81-550-XXL	190	81-642-L	191	82-021	197	82-021	197
81-231-XS	184	81-249-L	183	81-503-XXL	189	81-551-L	190	81-642-M	191	82-022	197	82-022	197
81-231-XXL	184	81-249-M	183	81-503-XXXL	189	81-551-M	190	81-642-S	191	82-023	197	82-023	197
81-231-XXXL	184	81-249-S	183	81-504-L	189	81-551-S	190	81-642-XL	191	82-024	197	82-024	197
81-233-L	184	81-249-XL	183	81-504-M	189	81-551-XL	190	81-642-XXL	191	82-025	197	82-025	197
81-233-M	184	81-249-XS	183	81-504-S	189	81-551-XXL	190	81-642-XXXL	191	82-026	197	82-026	197
81-233-S	184	81-249-XXL	183	81-504-XL	189	81-551-XXXL	190	81-643-L	191	82-027	197	82-027	197
81-233-XL	184	81-249-XXXL	183	81-504-XXL	189	81-555-L	189	81-643-M	191	82-028	197	82-028	197
81-233-XS	184	81-250-L	187	81-504-XXXL	189	81-555-M	189	81-643-XXL	191	82-029	195	82-029	195
81-233-XXL	184	81-250-LD	187	81-506-L	188	81-555-S	189	81-643-XXXL	191	82-070-39	196	82-070-39	196
81-233-XXXL	184	81-250-M	187	81-506-M	188	81-555-XL	189	81-647-L	191	82-070-40	196	82-070-40	196
81-234-L	183	81-250-S	187	81-506-S	188	81-555-XXL	189	81-647-M	191	82-070-41	196	82-070-41	196
81-234-M	183	81-250-XL	187	81-506-XL	188	81-555-XXXL	189	81-647-S	191	82-070-42	196	82-070-42	196
81-234-S	183	81-250-XXL	187	81-506-XXL	188	81-556-L	190	81-647-XL	191	82-070-43	196	82-070-43	196
81-234-XL	183	81-258-L	187	81-506-XXXL	188	81-556-M	190	81-647-XXL	191	82-070-44	196	82-070-44	196
81-234-XS	183	81-258-M	187	81-511-L	189	81-556-S	190	81-647-XXXL	191	82-070-45	196	82-070-45	196
81-234-XXL	183	81-258-S	187	81-511-M	189	81-556-XL	190	81-648-L	191	82-070-46	196	82-070-46	196
81-234-XXXL	183	81-258-XL	187	81-511-S	189	81-556-XXL	190	81-648-M	191	82-070-47	196	82-070-47	196
81-236-L	184	81-258-XS	187	81-511-XL	189	81-556-XXXL	190	81-648-S	191	82-090	195	82-090	195
81-236-M	184	81-258-XXL	187	81-511-XXL	189	81-558-L	190	81-648-XL	191	82-091	195	82-091	195
81-236-S	184	81-258-XXXL	187	81-511-XXXL	189	81-558-M	190	81-648-XXL	191	82-092	195	82-092	195
81-236-XL	184	81-410-L	188	81-530-L	192	81-558-S	190	81-648-XXXL	191	82-093	195	82-093	195
81-236-XS	184	81-410-LD	188	81-530-M	192	81-558-XL	190	81-649-L	191	82-094	195	82-094	195
81-236-XXL	184	81-410-M	188	81-530-S	192	81-558-XXL	190	81-649-M	191	82-095	195	82-095	195
81-236-XXXL	184	81-410-S	188	81-530-XL	192	81-565-L	186	81-649-S	191	82-096	195	82-096	195
81-238-L	184	81-410-XL	188	81-530-XXL	192	81-565-M	186	81-649-XL	191	82-097	195	82-097	195
81-238-M	184	81-410-XXL	188	81-532-L	192	81-565-S	186	81-649-XXL	191	82-098	195	82-098	195
81-238-S	184	81-420-L	186	81-532-M	192	81-565-XL	186	81-649-XXXL	191	82-100	196	82-100	196
81-238-XL	184	81-420-LD	186	81-532-S	192	81-565-XXL	186	81-659-L	192	82-101	196	82-101	196
81-238-XS	184	81-420-M	186	81-532-XL	192	81-565-XXXL	186	81-659-M	192	82-102	196	82-102	196
81-238-XXL	184	81-420-S	186	81-532-XXL	192	81-606-L	192	81-659-S	192	82-103	196	82-103	196
81-238-XXXL	184	81-420-XL	186	81-532-XXXL	192	81-606-M	192			82-104	196	82-104	196
										82-105	196	82-105	196



Ref	p.	Ref	p.	Ref	p.	Ref	p.	Ref	p.	Ref	p.
82-106	196	82-323	198	84-220+G	34	90-001	28	97-610-9	199	99-064	171
82-107	196	82-324	198	84-221	12	90-002	28	97-610-10	199	99-065	170
82-108	196	82-350	198	84-221+G	35	90-003	28	97-611	200	99-066	170
82-110	196	82-351	198	84-222	12	90-004	28	97-615	200	99-067	167
82-111	196	82-355	198	84-222+G	36	90-007	29	97-616-8	199	99-068	167
82-112	196	82-356	198	84-223	12	90-008	29	97-616-9	199	99-069	168
82-113	196	82-360	198	84-223+G	35	90-009	29	97-616-10	199	99-070	167
82-114	196	82-361	198	84-225	12	90-010	29	97-617-8	199	99-071	170
82-115	196	82-365	198	84-225+G	34	90-030	30	97-617-9	199	99-072	170
82-116	196	82-366	198	84-229	13	90-031	30	97-617-10	199	99-073	168
82-117	196	82-700	196	84-230	36	90-032	30	97-620-8	199	99-074	167
82-118	196	82-701	196	84-231	37	90-033	31	97-620-9	199	99-075	167
82-120	197	82-702	196	84-232	37	90-034	30	97-620-10	199	99-076	171
82-121	197	82-703	196	84-233	38	90-035	30	97-621-8	199	99-077	171
82-122	197	82-704	196	84-234	38	90-036	31	97-621-9	199	99-078	167
82-123	197	82-705	196	84-235	38	90-037	30	97-621-10	199	99-093	172
82-124	197	82-706	196	84-236	38	90-038	30	97-630-8	199	99-094	172
82-125	197	82-707	196	84-237	37	90-039	30	97-630-9	199	99-095	173
82-126	197	82-708	196	84-238	37	90-060	31	97-630-10	199	99-096	173
82-127	197	82-710	196	84-239	37	90-061	31	97-631-8	199	99-097	169
82-128	197	82-711	196	84-240	36	90-062	31	97-631-9	199	99-101	166
82-155-39	195	82-712	196	84-241	38	90-063	31	97-631-10	199	99-200	169
82-155-40	195	82-713	196	84-242	36	90-064	31	97-640-8	199	99-201	169
82-155-41	195	82-714	196	84-243	38	90-065	31	97-640-9	199	GD04	231
82-155-42	195	82-715	196	84-244	36	90-066	31	97-640-10	199	GD05	231
82-155-43	195	82-716	196	84-246	39	90-067	31	97-641-8	199	GD06	231
82-155-44	195	82-717	196	84-247	37	90-068	31	97-641-9	199	GD07	231
82-155-45	195	82-718	196	84-249	39	90-069	31	97-641-10	199	GD08	231
82-155-46	195	82-720	196	84-254	39	90-070	32	97-642-8	199	GD09	232
82-155-47	195	82-721	196	84-255	15	90-071	32	97-642-9	199	GD010	232
82-160-39	195	82-722	196	84-256	15	90-080	32	97-642-10	199	GD012	200
82-160-40	195	82-723	196	84-257	15	90-081	32	97-643-8	199	GD013	200
82-160-41	195	82-724	196	84-259	14	90-082	32	97-643-9	199	GD014	200
82-160-42	195	82-725	196	84-264	39	90-083	32	97-643-10	199	GD015	233
82-160-43	195	82-726	196	84-266	15	90-084	32	97-690-L	200	GD016	231
82-160-44	195	82-727	196	84-267	15	90-085	32	97-690-M	200	GD017	198
82-160-45	195	82-728	196	84-268	15	97-300	201	97-690-XL	200	GD018	198
82-160-46	195	84-060	16	84-269	15	97-301	201	97-691-L	200	GD019	198
82-160-47	195	84-061	16	84-271	13	97-311	201	97-691-M	200	GD020	198
82-165-39	197	84-062	16	84-274	13	97-321	201	97-691-XL	200	GD021	232
82-165-40	197	84-064	16	84-276	15	97-350	202	99-026	168	GD022	232
82-165-41	197	84-065	16	84-278	15	97-360	202	99-027	168	GD023	231
82-165-42	197	84-066	16	84-281	16	97-361	202	99-028	168	GD024	231
82-165-43	197	84-092	14	84-286	15	97-362	202	99-029	168	GD025	231
82-165-44	197	84-093	14	84-287	15	97-390	201	99-032	167	GD026	231
82-165-45	197	84-094	14	84-300	19	97-391	201	99-033	166	GD027	231
82-165-46	197	84-095	14	84-301	19	97-500	201	99-034	166	GD028	231
82-165-47	197	84-096	14	84-302	20	97-501	201	99-035	166	GD029	232
82-166-39	197	84-097	14	84-303	18	97-510	201	99-036	166	GD030	198
82-166-40	197	84-098	14	84-304	18	97-513	201	99-037	166	GD031	198
82-166-41	197	84-100	17	84-305	19	97-514	201	99-038	171	GD032	198
82-166-42	197	84-101	17	84-306	20	97-530	203	99-040	171	GD033	198
82-166-43	197	84-102	17	84-308	19	97-535	202	99-041	169		
82-166-44	197	84-105	17	84-311	20	97-536	202	99-042	169		
82-166-45	197	84-114	17	84-315	19	97-550	203	99-043	169		
82-166-46	197	84-115	17	84-330	20	97-551	203	99-044	169		
82-166-47	197	84-116	17	84-332	20	97-552	203	99-045	167		
82-300	197	84-118	18	84-333	21	97-553	203	99-047	170		
82-302	198	84-119	18	84-334	21	97-554	203	99-048	170		
82-303	198	84-130	18	84-335	20	97-555	203	99-049	172		
82-310	198	84-131	18	84-350	15	97-590	202	99-050	172		
82-311	198	84-140	23	84-401	22	97-602	200	99-051	172		
82-312	198	84-141	23	84-402	22	97-603	200	99-052	172		
82-313	198	84-142	22	84-403	22	97-604	200	99-053	172		
82-314	198	84-143	22	84-404	13	97-605	200	99-054	172		
82-315	197	84-144	21	84-405	22	97-606	200	99-059	173		
82-316	197	84-217	12	84-500	21	97-609-8	199	99-060	173		
82-320	198	84-217+G	35	84-501	21	97-609-9	199	99-061	173		
82-321	198	84-218	13	84-502	21	97-609-10	199	99-062	173		
82-322	198	84-220	12	84-503	21	97-610-8	199	99-063	172		





GRAPHITE
125x1,6x22,2 mm
41 A60-T-BF
EN 12488
57x1700
graphite.pl
1000990

NEO
TOOLS

80T
E mm